



IT TAKES A VILLAGE

Project Location:

2000 South Industrial Hwy
Ann Arbor, MI

Project Team Members:

Gabriella Ragano
Margaret Jane Gies
Nathanael Nelson

Systems Studio Section:

Ellie Abrons
Meredith Miller

Taubman College of Architecture and Urban Planning
University of Michigan
Arch 672 Systems Studio Fall 2022

CONTENTS

Project Narrative and Statistics

Design Proposal

Assignments

Precedent Studies

Consent Statement

IT TAKES A VILLAGE

Gabriella Ragano, Margaret Jane Gies, Nathanael Nelson
Systems Studio Section: Abrons & Miller

Project Statistics

Total gross floor area	83,100 sf
Lot area	196,020 sf 4.5 acres
FAR	0.59
Number of floors	3
Building height	32'-6"
Dwelling unit count and bedroom count	75 units 183 beds
Dwelling units/acre	16.67
Total area of commercial space	8450 sf
Total net leasable area	74,650 sf
Efficiency rate in %	11.32%
Unit Access typology	
Building Typology	
Number of on-site parking spaces	98
Parking spaces per unit	1

PROJECT NARRATIVE

The number one need as identified by the ann arbor housing commission and avalon developers, is housing for families and long term rental residents. The factors as framed by the studio prompt - lack of housing stock and high demand for affordable housing - has caused a crisis for lower income families who cannot find anywhere within the city to live. We were driven by a three part framework of affordability, dignity, and collectivity, to create a proposal that is site specific yet highly modular.



Residential Story

With this in mind, we will introduce the overall proposal, of residents in mind, through the character of Desiree who will walk us through a typical routine returning from work to her home. They've just arrived to their home now. They've parked and see their neighbors about as they stroll up the walk. In front of the home now, Oliver can easily recognize it. Inside Desiree puts down her things and searches the living room for one of the many items that have been lost in their chaotic lives.



Oliver's excited to be home and runs straight through the first floor toward the glass doors to a shared inside - a plus space. In this plus space, Oliver finds his neighbor friends

next door already playing. Desiree watches over Oliver and the neighbor kids playing ball while shaded under the wood slat pergolas. The day passes fast, but Oliver and Desiree are very excited to join the rest of the village in the plus space to watch their favorite movie. What a great way to end the day.



Desiree and her children are one family within a dense micro community that interact on a daily basis, throughout the year. The plus space ties every unit together in a semi-enclosed hardscape with moments of vegetation, shading, and activity. While there is an option to live without ever interacting with the plus space, the target market of families and renters, and intentionally designed massing, foster vibrant instances of community building. Through the understanding of the resident, we were able to create a sensitive, nuanced design that puts the residents of this space first above all else.

Massing Strategy

We were inspired by the ability of villages and neighbors to share space, time, resources, and responsibilities. By focusing on each resident having a front door access on the ground floor and a shared plus space access on the inside of their home a unique typology was created. Each unit was then expanded upwards two or three floors. The floors were the pushed and pulled to create unique plus spaces and internal facade spaces within the wood slat shell that dug into and pushed out of the residential spaces. The units were then added on to in order to create an elbow building typology that was aggregated five times across the site.

Unit and Building Strategy

Our project utilizes 3 different typologies including a townhomes, walk-up, and a group floor accessible unit type. The townhomes range from 2 floors to 3 floors and contain 2-5 bedrooms. In the project we have five 5 bedroom units, 7 four bedroom units, fourteen 3 bedroom units, nineteen 2 bedroom units, ten ada units, and 20 walk up units split between 1 and 2 bedrooms.

The floors of the multi story townhomes are modular and interchangeable. This gif goes through a couple of the different combinations of the multiple floors. The floors step in on the second floor in the inside or plus space to allow for sharable balconies. On third floor there are units that step in on the outside or car side of the building to allow for a large connected elevated plus space as well as the front trellis condition shown in elevation.

Every unit has its own facade and exterior entry with direct access to the embedded plus space. Because of the modularity of the upper floor plans the ground floor of all the multi level units is the same with some rotating of the kitchen and living room spaces. The ground floor of the units bleeds into the plus space between the units with built in elements such as bars the allow for use both inside and outside of the unit. Other built in elements include grills, benches, and planter boxes for sharing between residents. We also imagine that this space will be populated by the residents themselves as a shared backyard so this is shown with different tables and outdoor furniture. This shared space between the units is optimal for families as it allows children and adults from different units to interact with each other with full view from the inside of each of the units. This will allow for community building and shared child care.

The second floor of the building becomes a much more private and as you can see pushes all the way forward on the outside to allow for a uniform facade. There are a series of smaller balconies some of which are shared and others are private to only the residents of that unit. The elevate plus space is organized so that if a unit is given less space

in the second floor they are given more access to plus space on the third floor. The walk up units are on this floor and are accessed via the main stair in the plus space and the secondary stair that is on the outside of the plus space.

The third floor opens back up with more shared spaces that would be accessed only by the residents of this building complex. These building plans show one of the five different resident buildings that we have on our site. Each of the five buildings has a slightly different number of units which modifies how the plus space is organized however all buildings follow the same logic utilizing the modular floor plans.



Looking at the plus space from one of these shared second floor balconies you can see the visual connection between the balconies as well as the trellis that covers the plus space below.

Structure and Facade Strategy

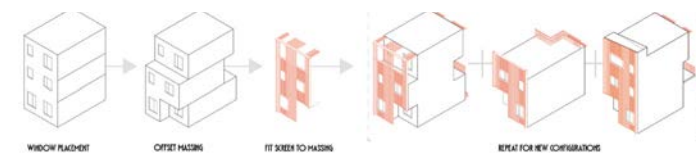

Our structural strategy was to utilize Cross Laminated Timber as the 3 and 5 layer slabs can span our 18 ft unit width without the need for additional column supports. The CLT yields to the ethos of our project. Affordability in that the CLT can be modularly built and implemented with ease. Dignity in that we are striving to provide our residents with a

home that they want to return to - the exposed CLT on the inside of the unit helps to create this reality. Collectivity in that the CLT easily enables the modular construction of adding units together to create a shared plus space inbetween the units. Additionally, as seen in the wall sections, the CLT facade allows for the pushing and pulling of a permeable elevation shelled by a wood slat system that furthers the understanding of the pushing and pulling notion. They are designed as 1.5 in width by a variable 1.5 - 10 in deep slat. The wood slats echo visual and tactile nature of the design, creating a touchable surface and a minute separation of townhomes.

Site Strategy

We had a number of site concerns to consider when creating this site design strategy; the watertower in the northwest corner that needed to remain and be accessible, the railroad along the west side of the site that passes randomly throughout the day, industrial highway that is mildly trafficked thoroughfare, a residential context, and gas fill-up for firetrucks and city vehicles that is regularly accessed. Traversing through numerable site plan, we landed on a site design that pushed the commercial fixtures on the urban edge to Industrial Highway. This enabled a continuous traffic loop encompassing the residential units. We wanted to protect the residential spaces from cars so we provided a protected, non-car living area and a large open green space for all residents to use. Residential buildings and their accompanying plus space dissipate into the central green promenade space for a larger scale of movement and green space. The promenade has patches of wild regrowth and meadows interwoven with permeable and impermeable pavers for circulation. The commercial



building on the eastern urban edge of the site functions as a childcare facility, Ann Arbor Housing Commission offices and workshop, on the first floor and storage, and a community center on the second floor. The building is strategically located inbetween the parking lot, the highway, and the green promenade. This site strategy responds to and is created with the residents, and their unique needs, as central to the design.



RESIDENT

...Desiree and her children travel up the sidewalk just coming from the bus stop...

Site Entrance Perspective



...Desiree and Oliver stroll up the walk to their home...

Building Entrance Perspective



...Desiree and Oliver enter their home and Desiree searches the living room for one of the many lost items in their chaotic lives....



...Oliver, excited to be home, runs straight through the first floor out toward the glass doors to the shared inside - a plus space...

Internal Perspective
First Floor Unit



...Inside the plus space, Oliver finds his friends who are already playing...

Mirrored East Elevation
Inside Plus Space



...Desiree watches Oliver and the neighbor children as well as they play ball late into the day. She is nicely shaded under the wood slat system...

Internal Perspective
Inside Plus Space



...the day passes fast, but Oliver and Desiree are excited to watch their favorite movie with the rest of the village in the plus space. What a great end to the day...

External Perspective
Third Floor Terrace



...In this cutaway, Desiree, Oliver, and all their neighbors can be seen doing activities cocurrently in their village building...

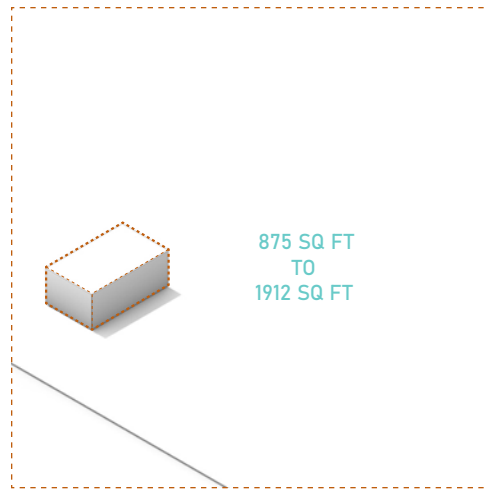

RESIDENTIAL UNITS SIZED FOR FAMILIES

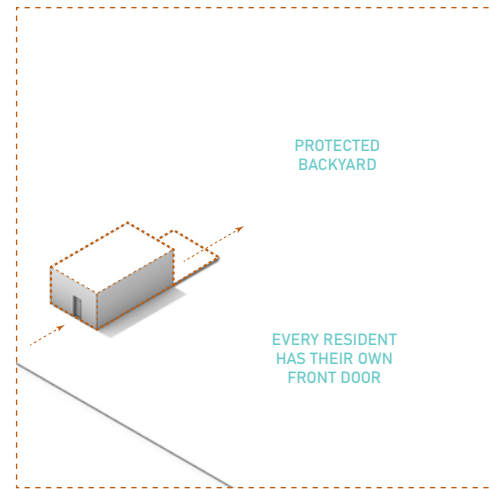

INDIVIDUAL FRONT DOOR / SHARED BACK SPACE

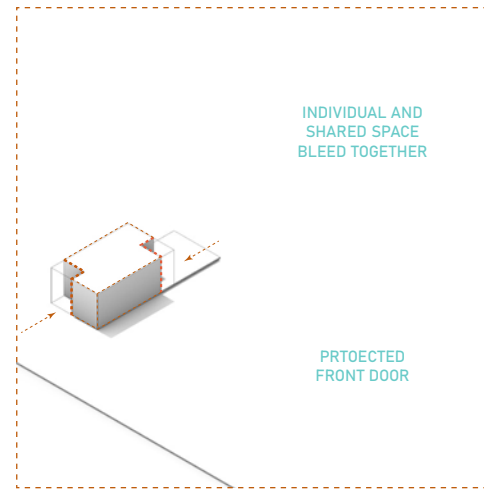

PUSH AND PULL RESIDENT UNIT

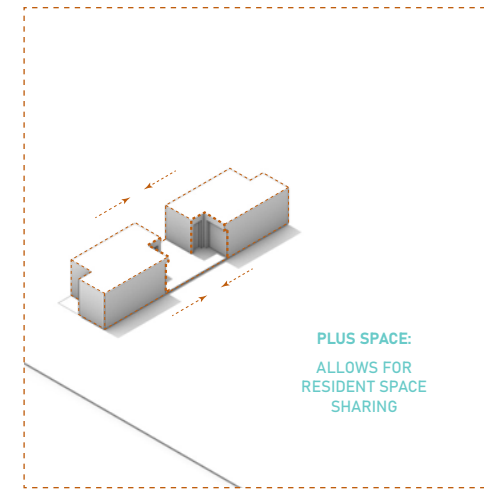

MIRROR UNITS TO CREATE PLUS SPACE

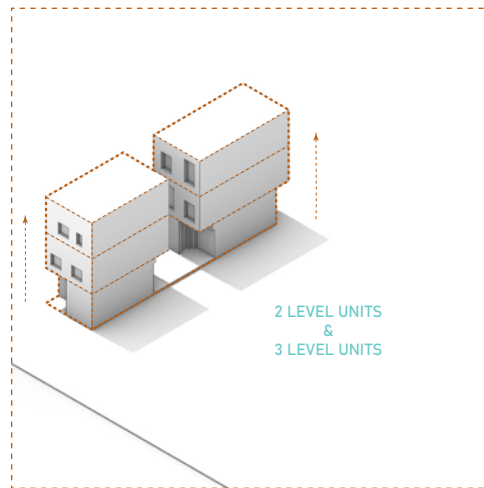

ADD HEIGHT FOR LARGER SIZED UNITS

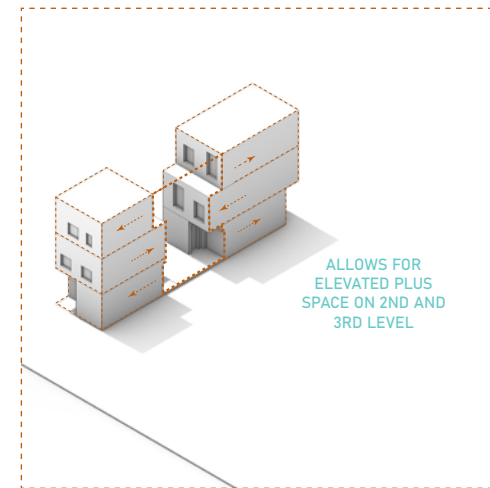

PUSH AND PULL TO OPTIMIZE PLUS SPACE

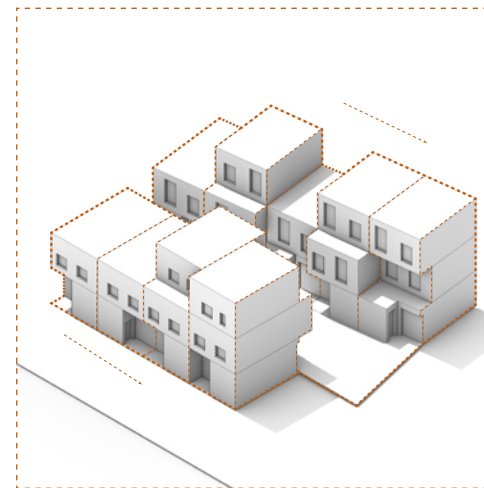

ADD UNITS TO DENSIFY

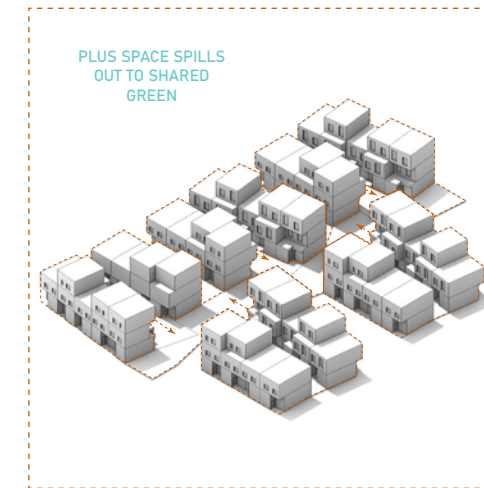

SHARED VILLAGE LIVING

RESIDENTIAL UNITS

LEVEL ONE

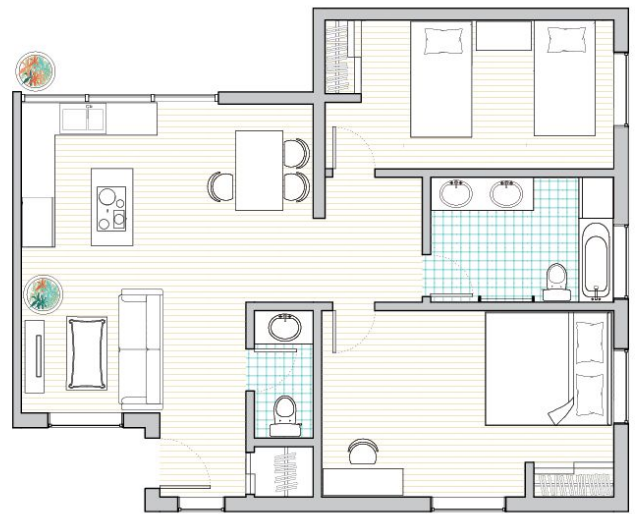
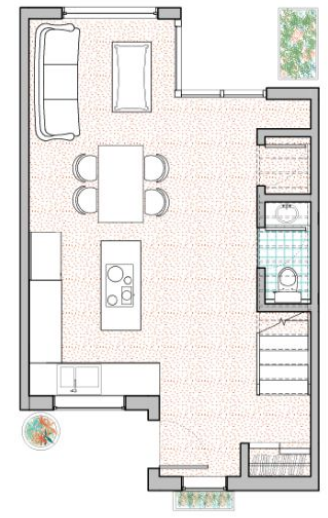
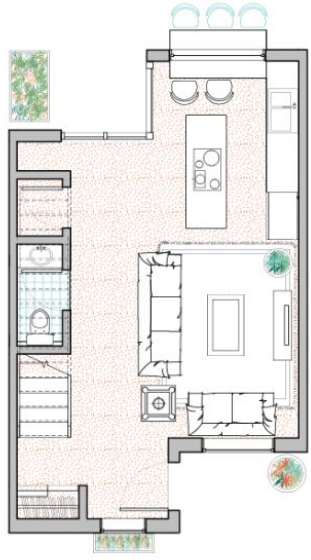

LEVEL TWO

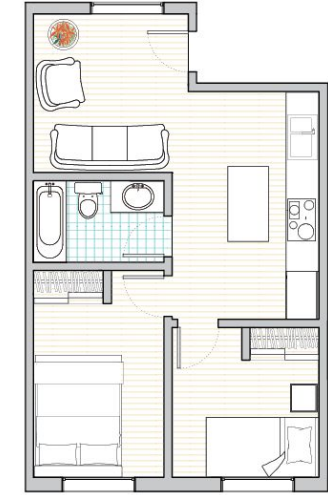
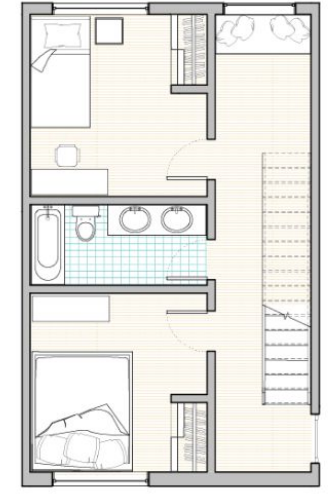
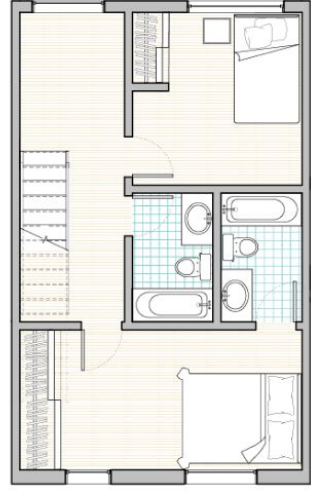
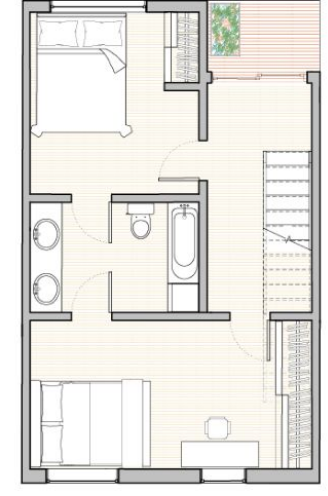
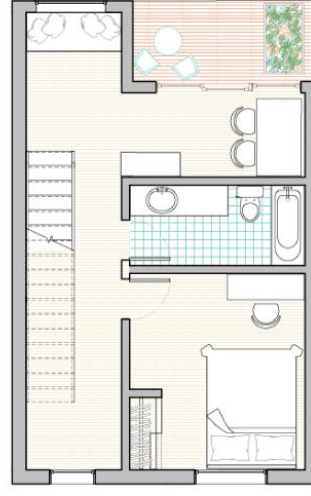

LEVEL THREE

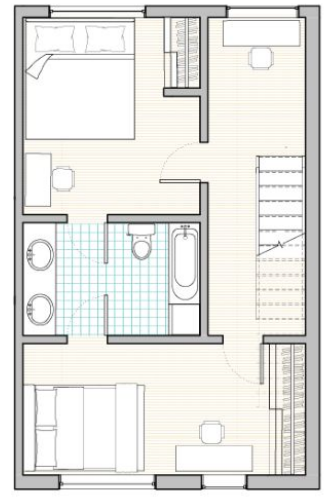
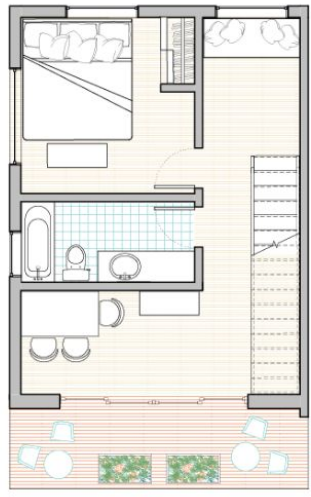

LEVEL ONE

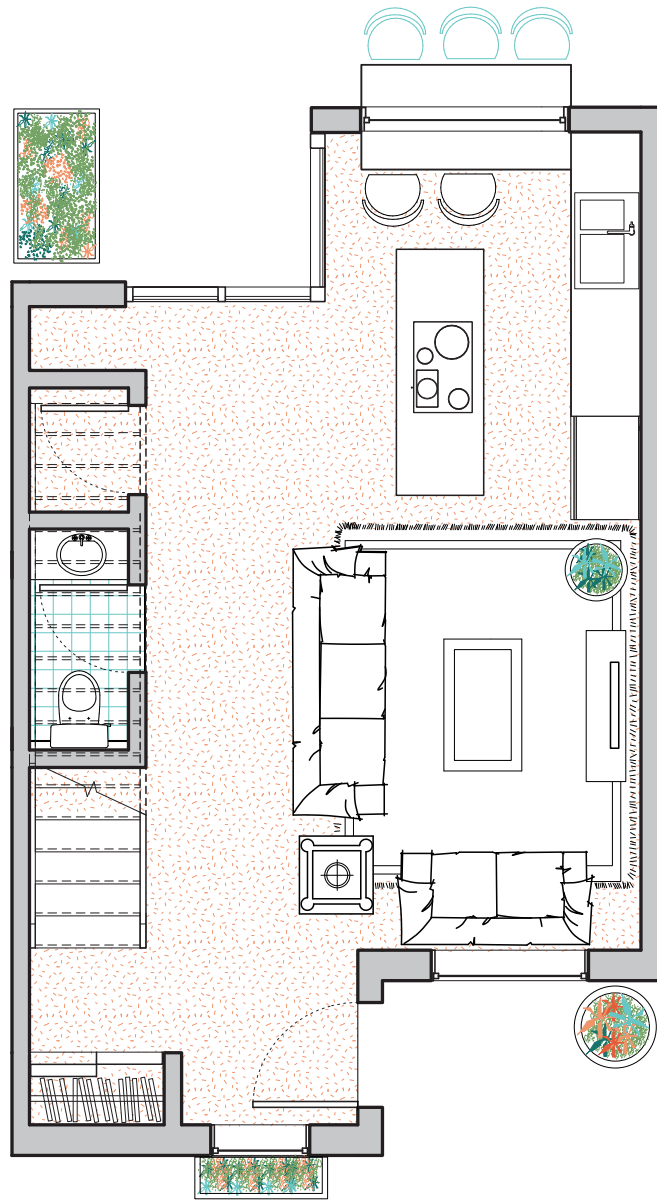

LEVEL TWO

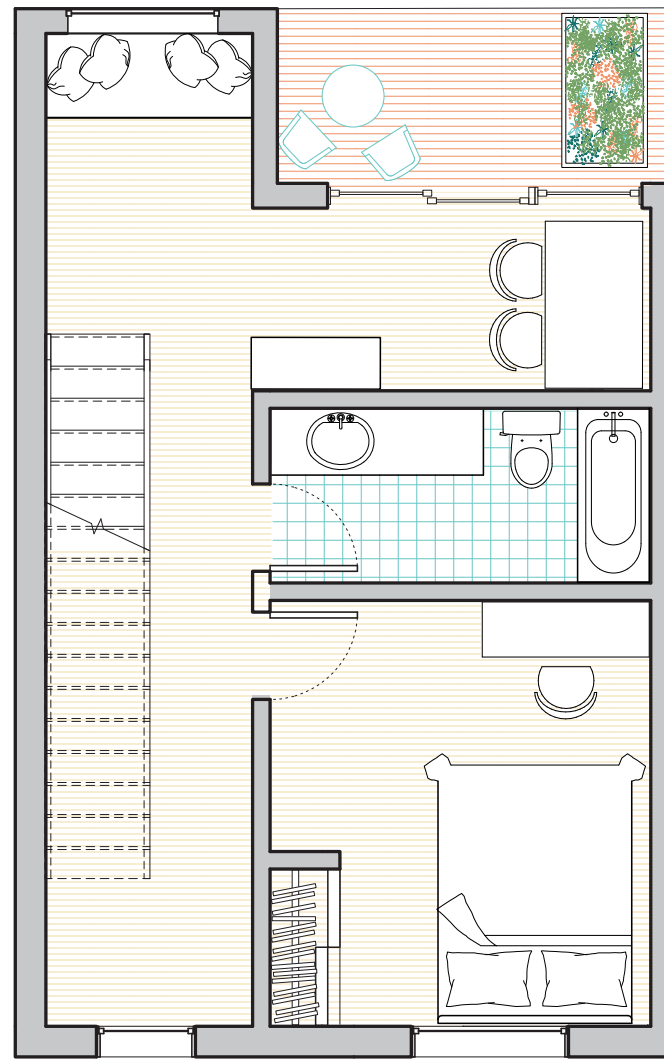

1 BEDROOM
1 BATH

LEVEL THREE

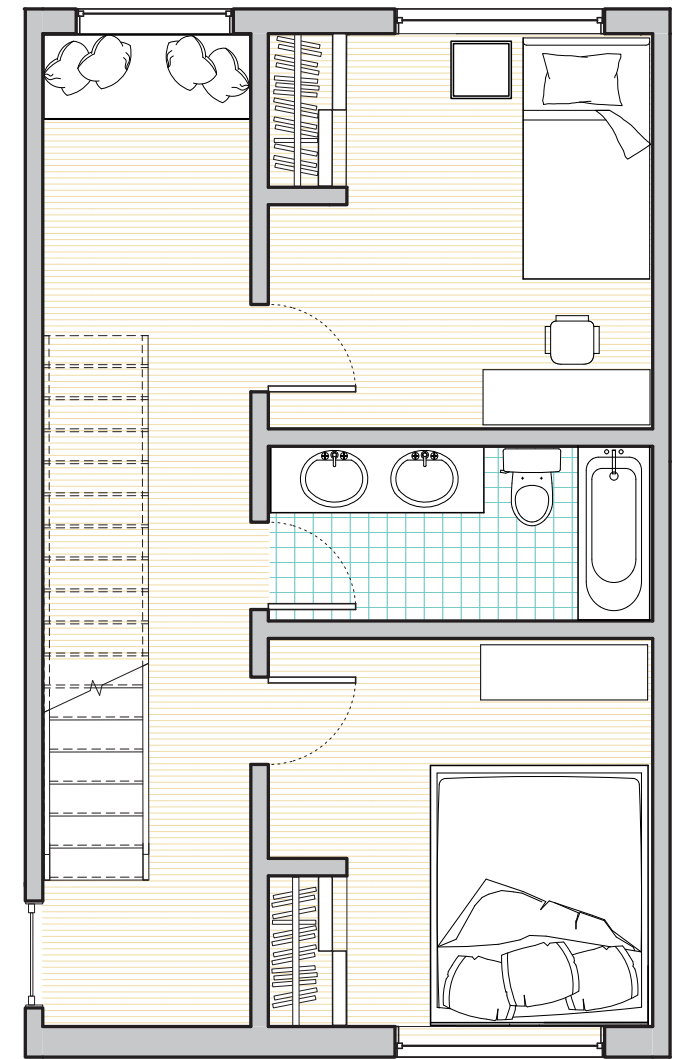

2 BEDROOM
1 BATH

LEVEL ONE

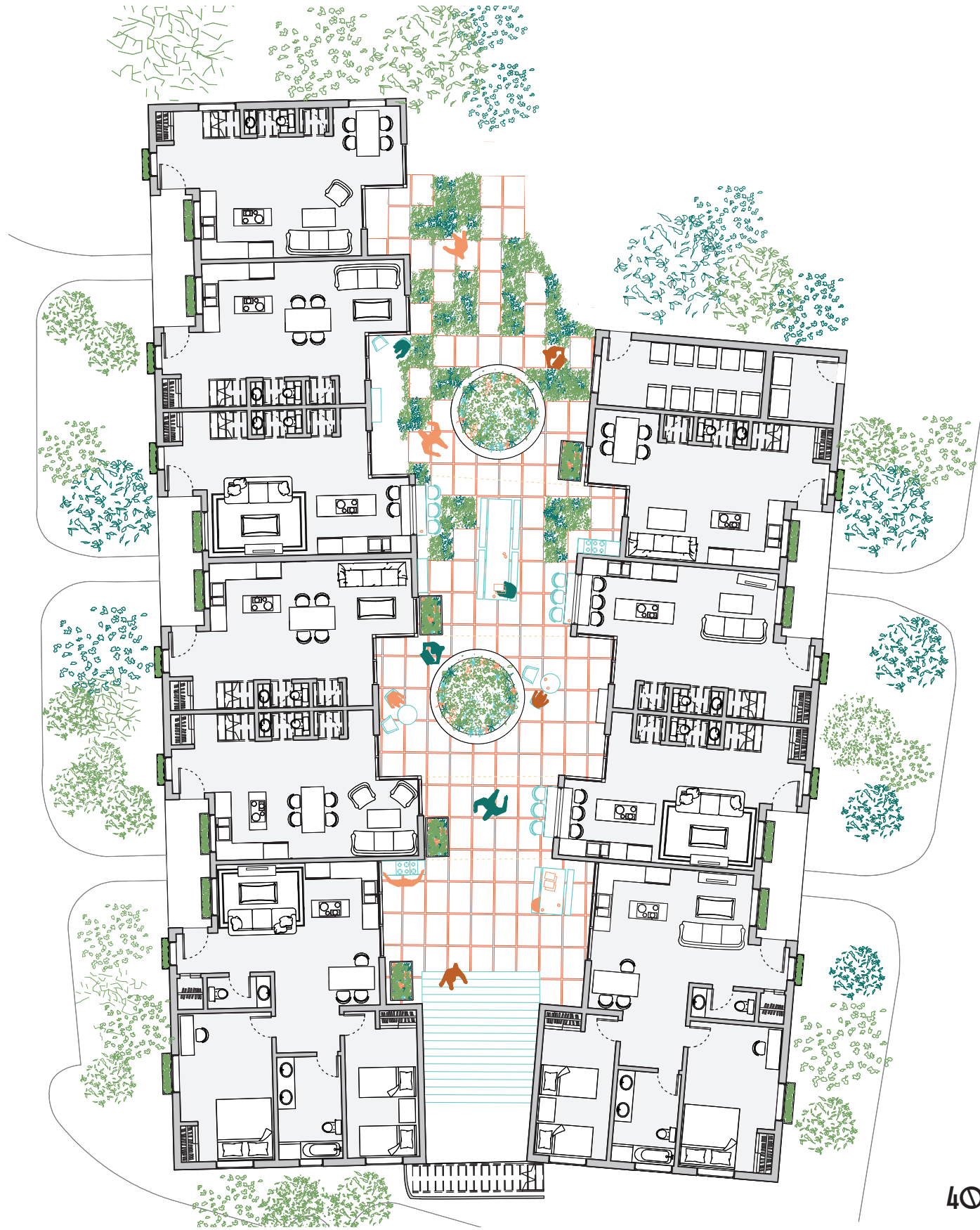

BUILDING

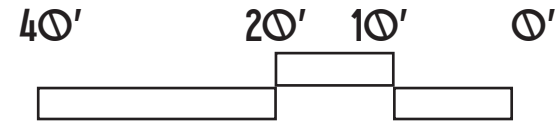

LEVEL TWO

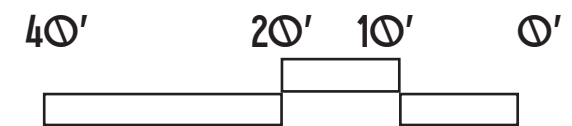
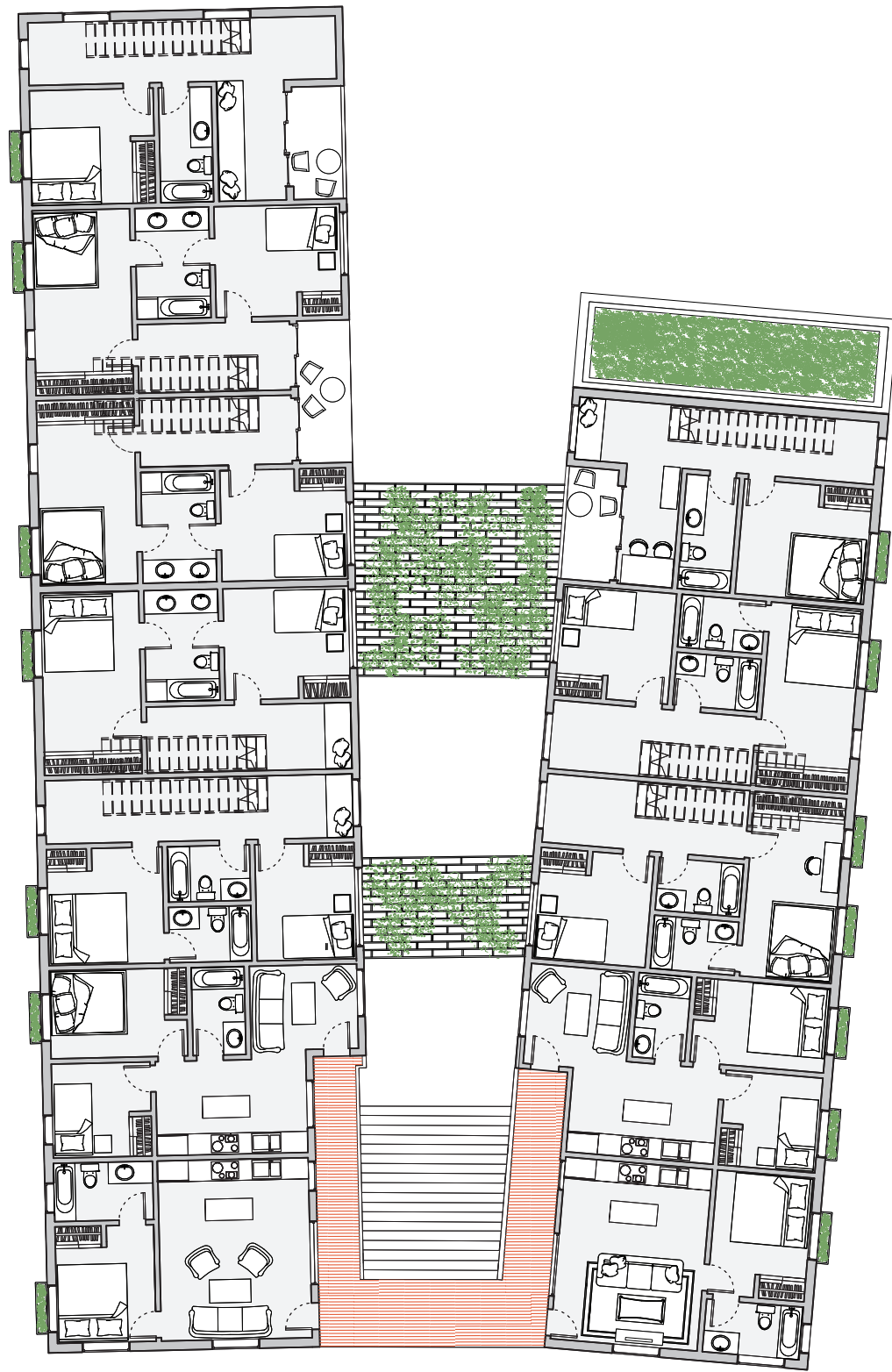

LEVEL THREE

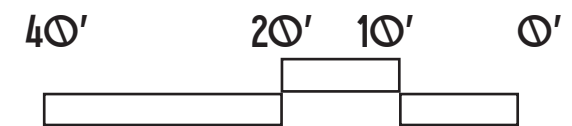
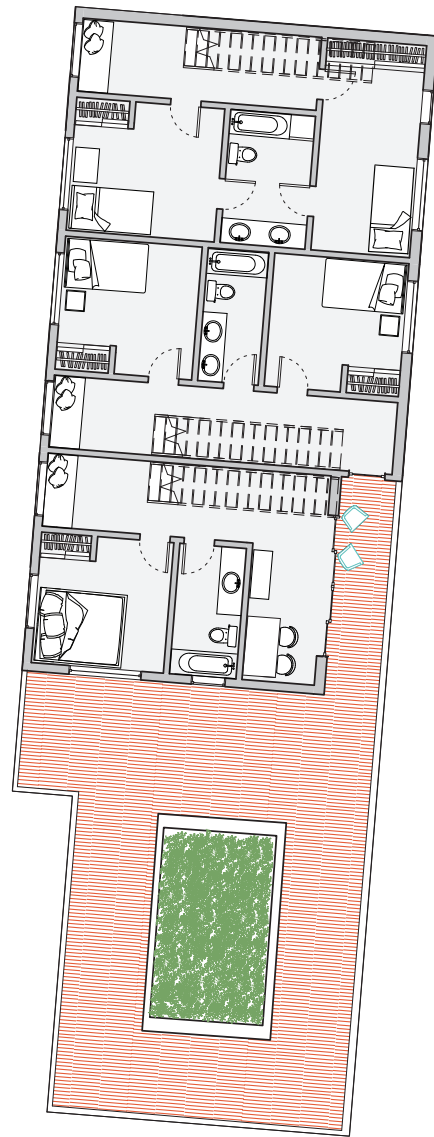
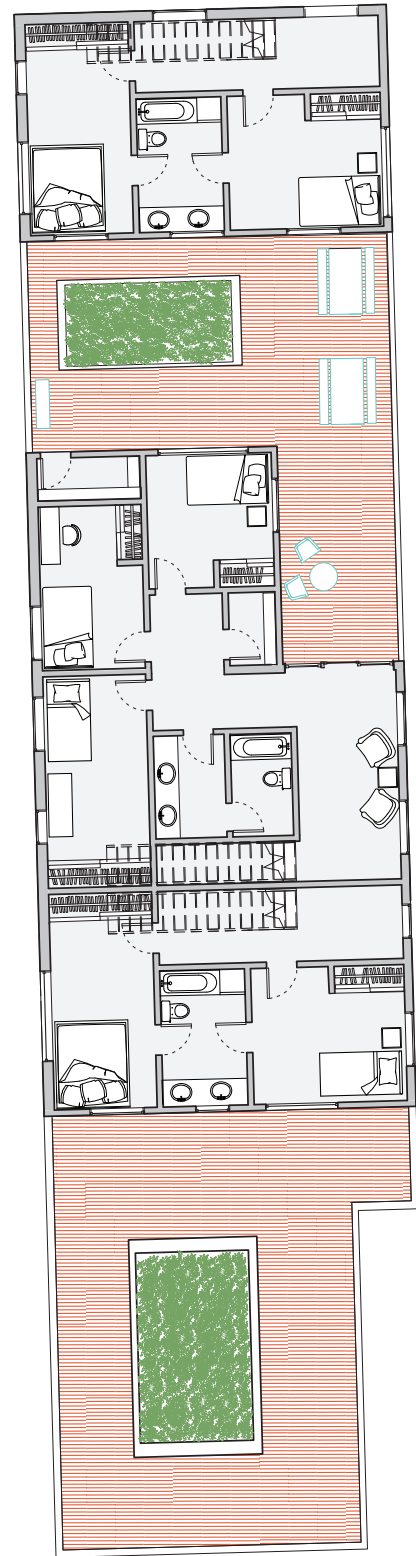



Internal Perspective
Second Floor Balcony

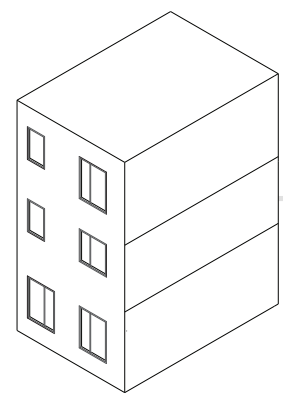

WINDOW PLACEMENT

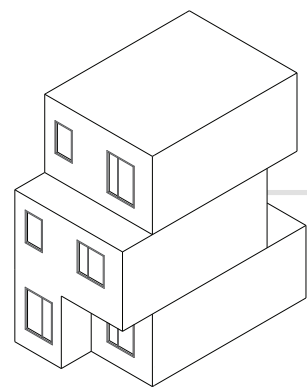

OFFSET MASSING

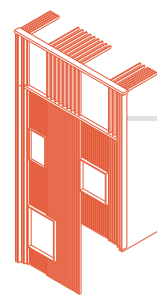

FIT SCREEN TO MASSING

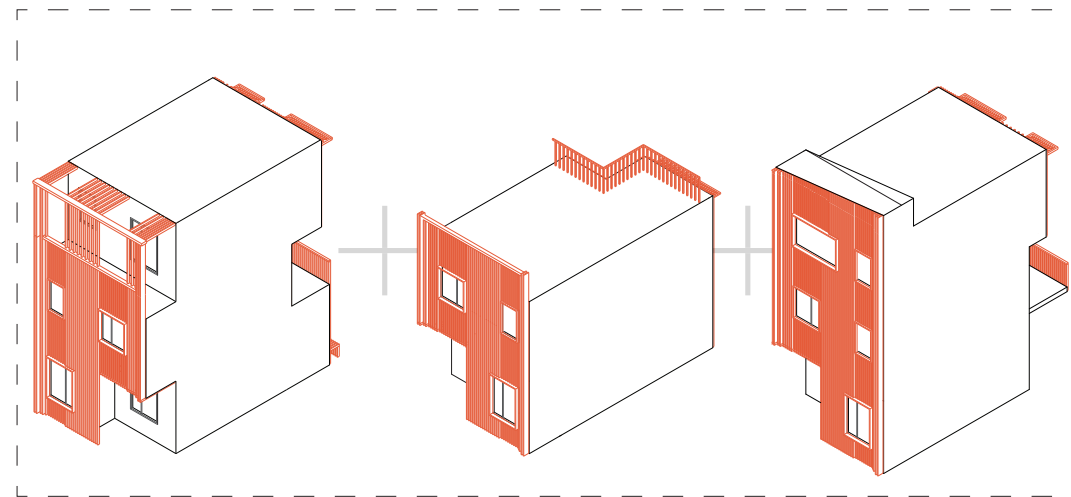

REPEAT FOR NEW CONFIGURATIONS

FACADE

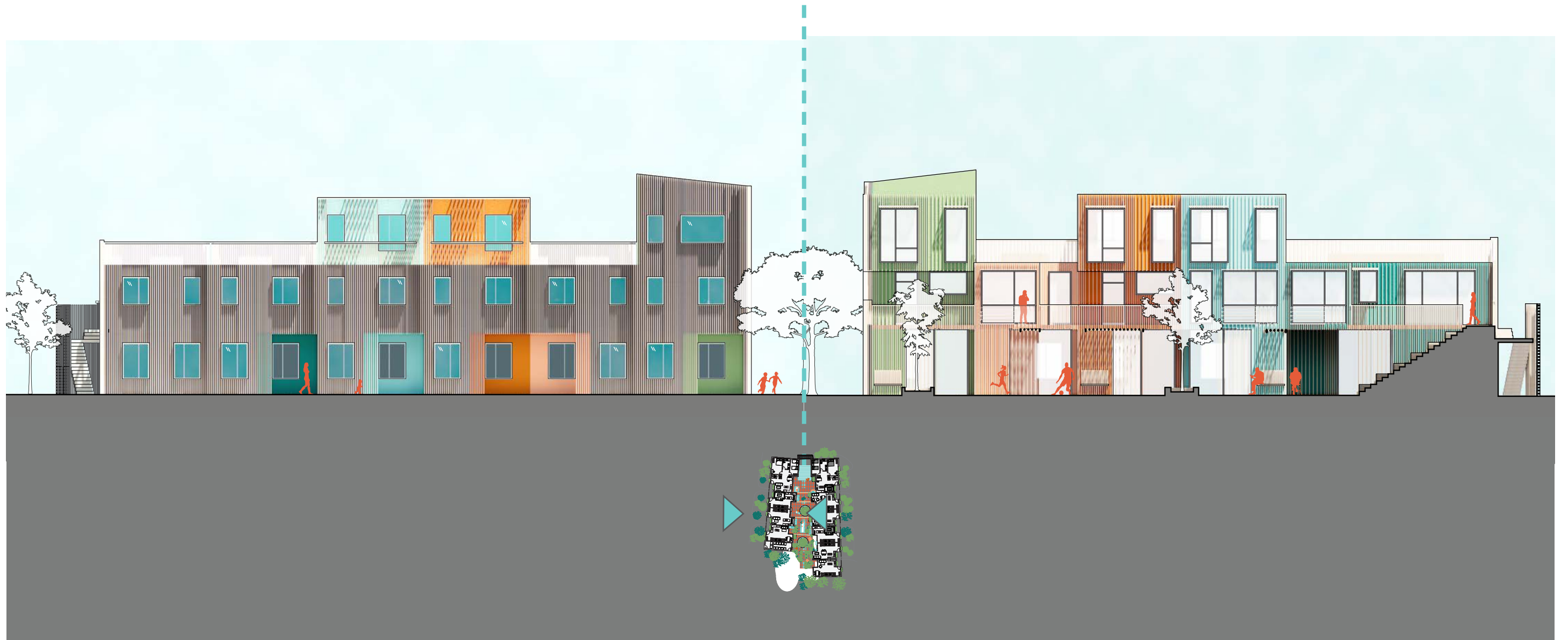

East Elevation & Inside East Elevation

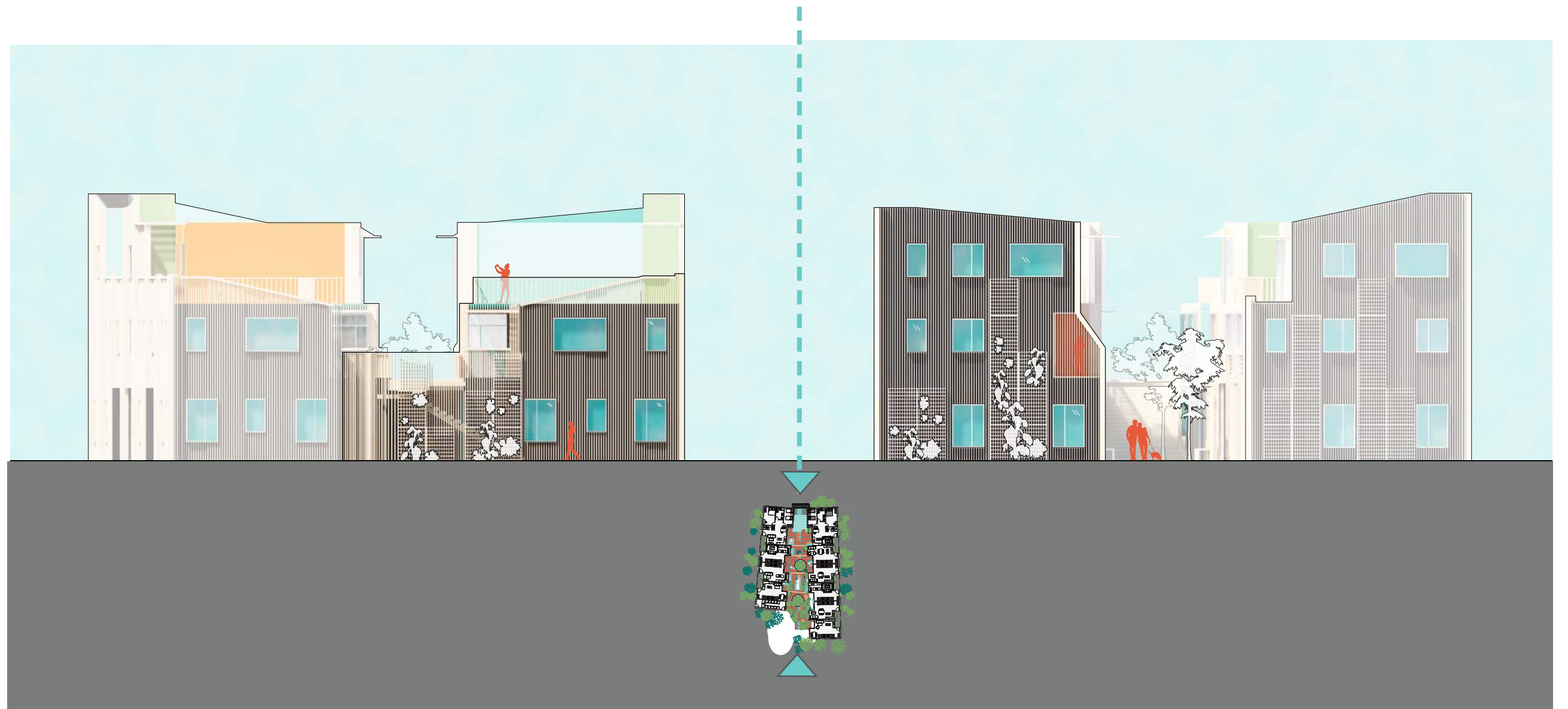

South Elevation & North Elevation

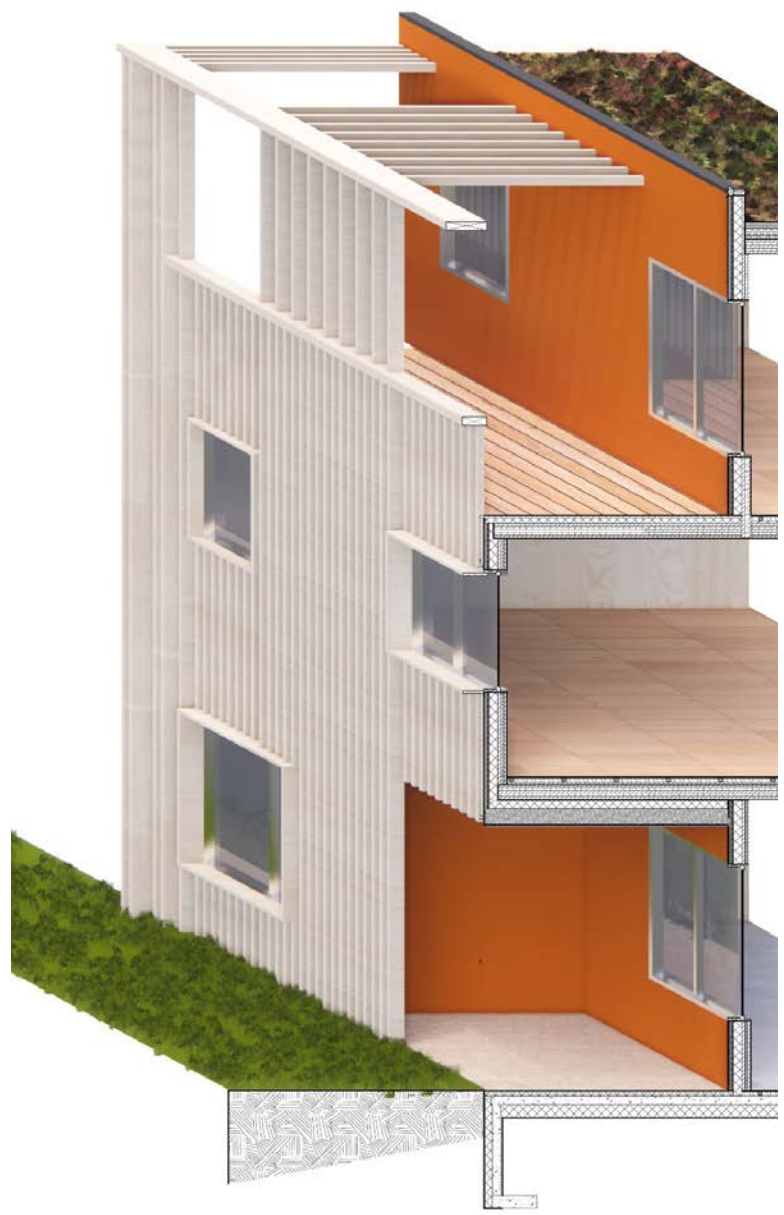

- PARAPET
32' - 6"
- ROOF
32' - 0"
- LEVEL 2
22' - 0"
- LEVEL 2
12' - 0"
- LEVEL 1
0' - 0"

CLT CANTILEVER FLOORING DETAIL

SCALE: 1/4" = 1' - 0"

- 1/4" Vinyl Flooring
- Radiant Heating Pipes in 1" Subfloor
- 1" Rigid Insulation
- 6/875" 5-layer CLT
- 2" Rigid Insulation
- 1" Wood Fiber Board
- 5/8" External Sheathing w/ Applied Stucco Finish
- Air Gap
- 3/4" Bracket
- Wood Slats

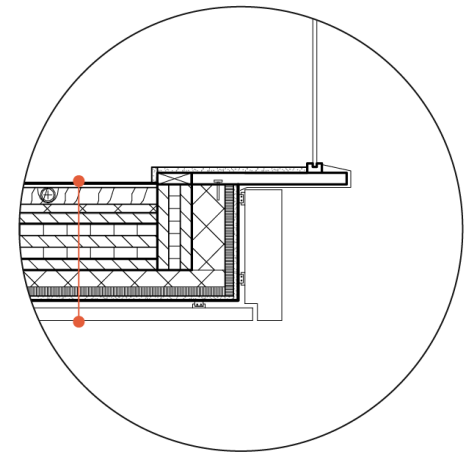

CLT EXTENSIVE GREEN ROOF DETAIL

SCALE: 1/4" = 1' - 0"

- 4" Sedums
- 1/8" Filter Fabric
- 3" Drainage Board
- 1/2" Root Barrier
- Impermeable Waterproof Liner Tray
- EPDM Membrane
- 2" Rigid Insulation
- Vapor Retarder
- 6.875" 5-layer CLT

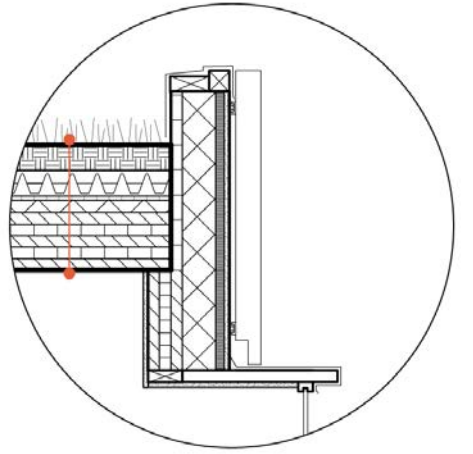

Wall Section Perspective
Outside and Inside & Details



WOOD SLAT DETAIL PLAN
SCALE: 1 1/2" = 1' - 0"

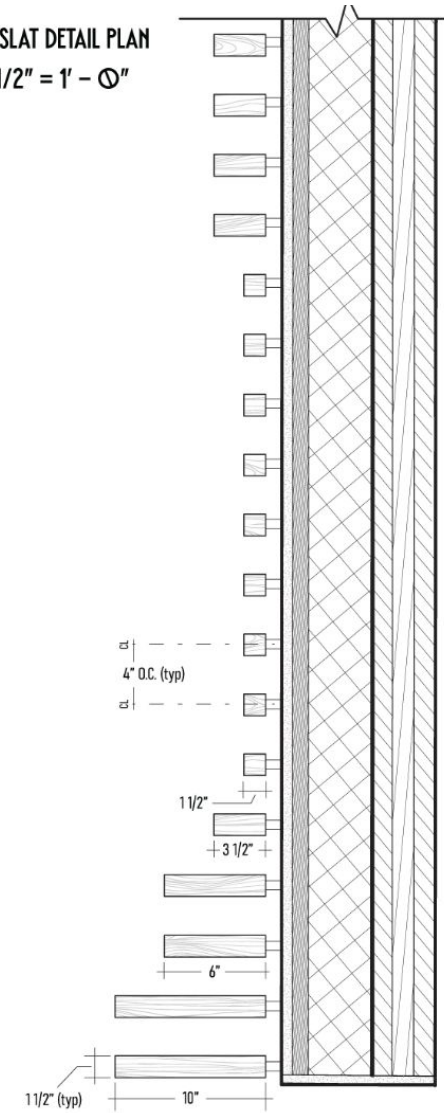

External Perspective
Third Floor Terrace



SITE

Site Considerations:

_ Railroad along West side of site that passes randomly throughout the day

_ Watertower in NorthWest corner that must remain

_ Gas Fill-up for firetrucks and city vehicles that is regularly accessed

_ Industrial Hwy is a mildly trafficked thoroughfare

_ Residential Context

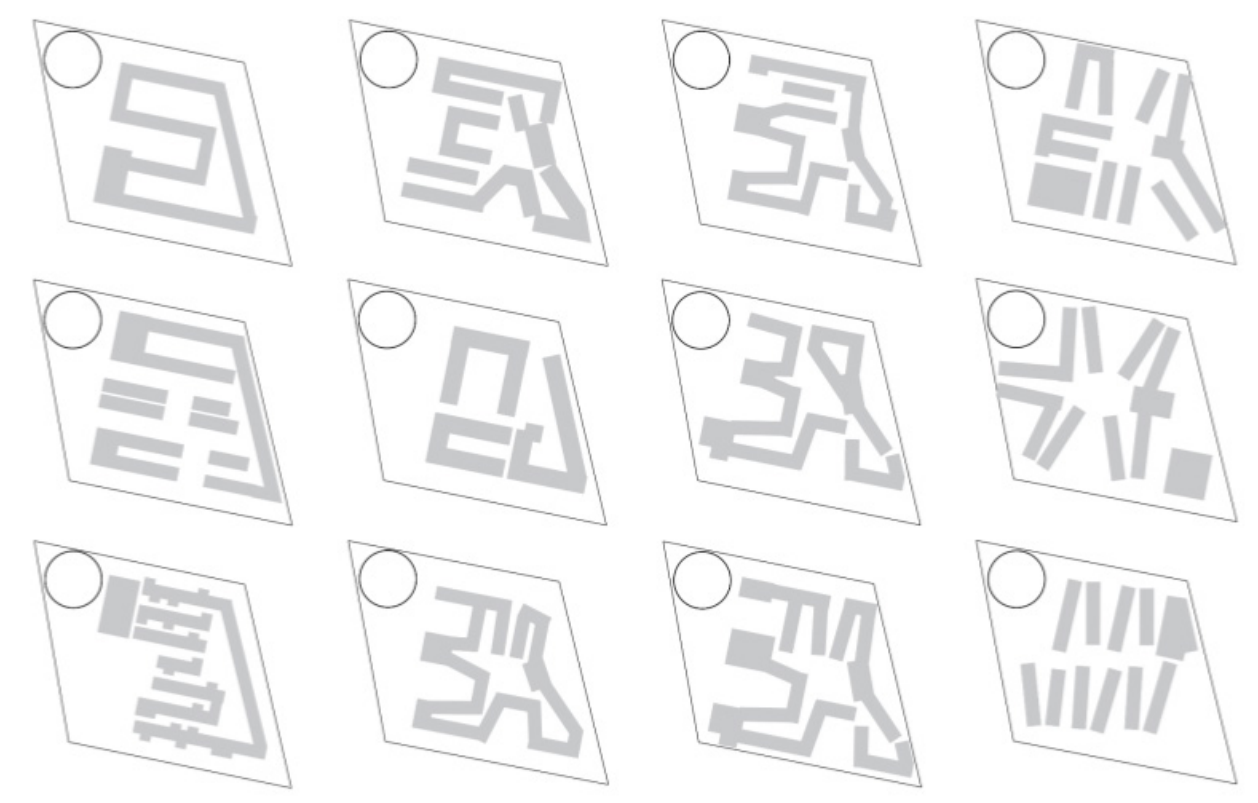
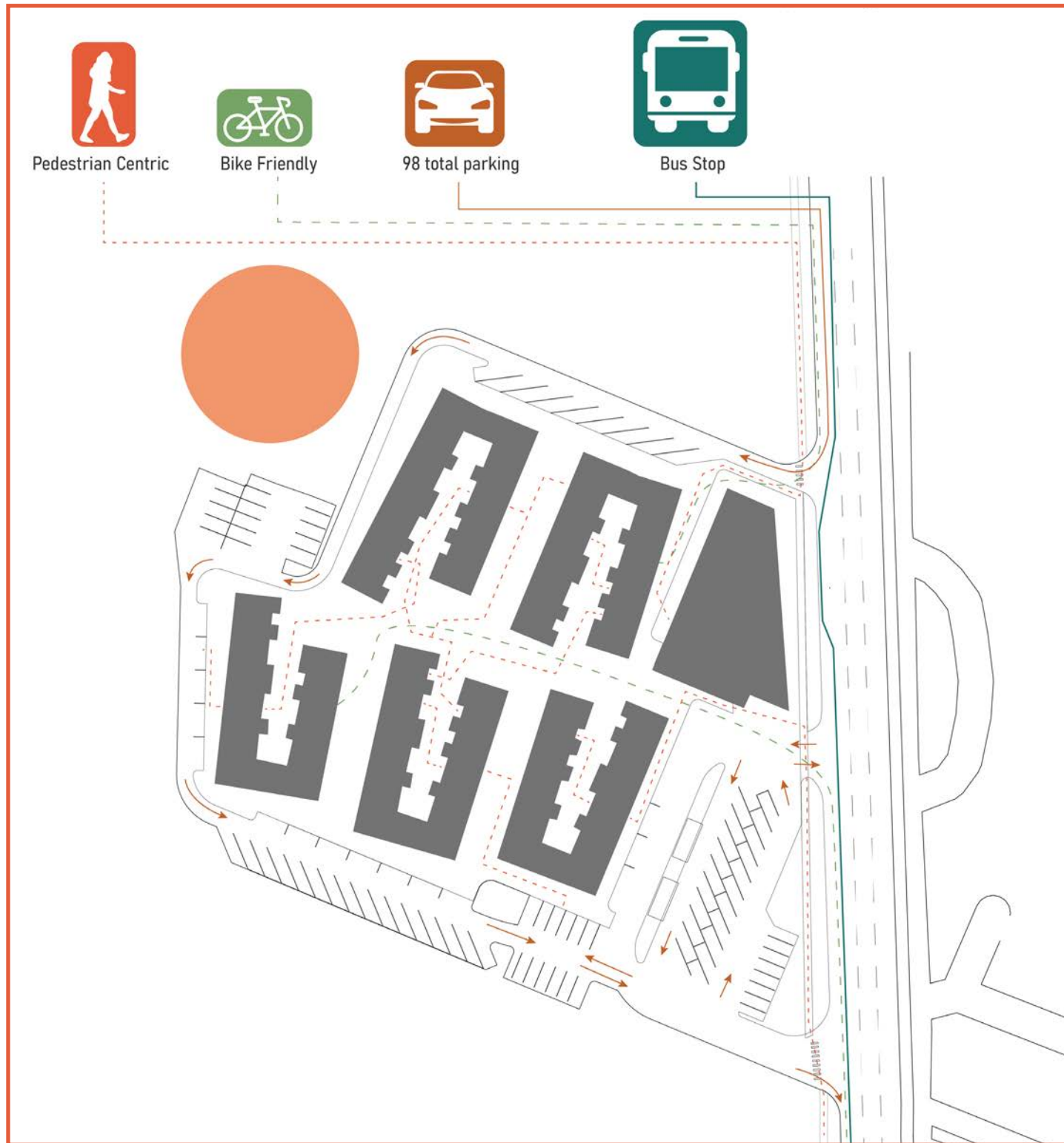

Site Circulation and Site Strategies Iterations



Site Information:

_DUA: 18.75

_GSF: 74,650

_FAR: 0.43

75 Units Total

5 - 5 Bed, 3.5 Bath Units	1912 Sq Ft
7 - 4 Bed, 3.5 Bath Units	1425 Sq Ft
14 - 3 Bed, 2.5-3.5 Bath Units	1425 Sq Ft
19 - 2 Bed, 1.5 - 2.5 Bath Units	925 SqFt
10 - ADA 2 Bed, 1.5 Bath Units	875 Sq Ft
10 - 2 Bed, 1 Bath Units	464 Sq Ft
10 - 2 Bed, 1 Bath Units	420 Sq Ft



Site Plan

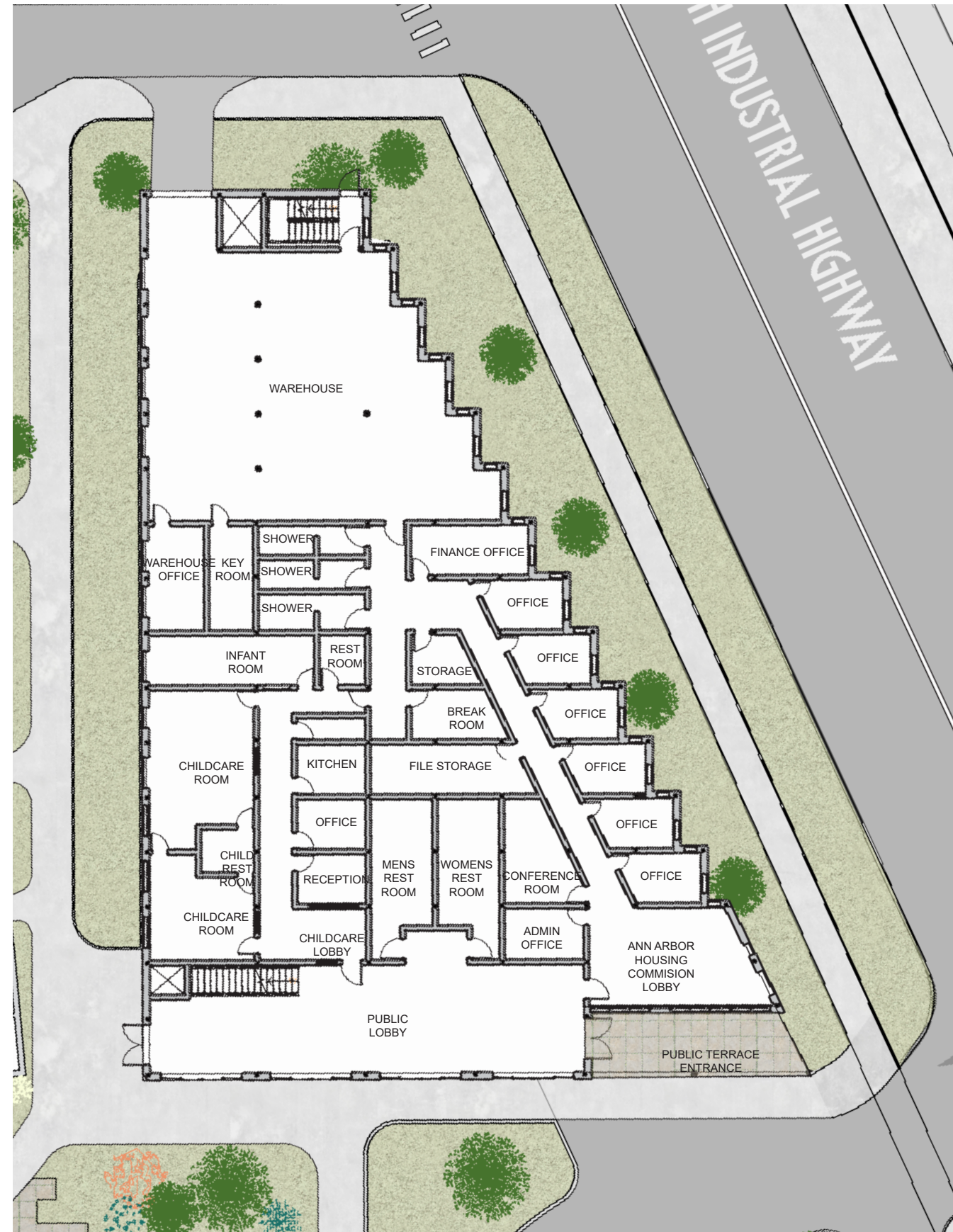

Community Center
First Floor Plan



External Perspective
Promenade