

ADDENDUM No. 2

ITB No. 4476

Street Crack Treatment - 2017

Bids Due: March 29, 2017 at 10:00 A.M. (local time)

The following changes, additions, and/or deletions shall be made to the Invitation to Bid for Street Crack Treatment - 2017, ITB No. 4476, on which proposals will be received on/or before March 29, 2017, at 10:00 A.M. (local time).

The information contained herein shall take precedence over the original documents and all previous addenda (if any), and is appended thereto. **This Addendum includes 54 pages.**

Bidder is to acknowledge receipt of this Addendum No. 2, including all attachments (if any) in its Bid by so indicating on page ITB-1 of the Invitation to Bid Form. Bids submitted without acknowledgment of receipt of this addendum will be considered nonconforming.

The following forms provided within the ITB Document must be included in submitted bids at bid opening.

- City of Ann Arbor Prevailing Wage Declaration of Compliance
- City of Ann Arbor Living Wage Ordinance Declaration of Compliance
- Vendor Conflict of Interest Disclosure Form
- City of Ann Arbor Non-Discrimination Ordinance Declaration of Compliance

Bids that fail to provide these completed forms listed above upon bid opening will be rejected as non-responsive and will not be considered for award.

I. CORRECTIONS/ADDITIONS/DELETIONS/CLARIFICATIONS

Changes to the Bid documents which are outlined below are referenced to a page or Section in which they appear conspicuously. The Bidder is to take note in its review of the documents and include these changes as they may affect work or details in other areas not specifically referenced here.

Item #1: Pre-Bid Conference Agenda and Sign-In Sheet pages Addendum-1-3 thru Addendum-1-4

(Note: No prospective bidders and only City of Ann Arbor staff attended the Pre-Bid Conference; therefore, a summary of the meeting was not prepared.)

Item #2: Bid Documents - Bid Form page BF-1; replace this page with attached page Addendum-1-5.

Item #3: Insert Detailed Specification for Resident Notification page Addendum1-6.

Item #4: Detailed Specification for Project Schedule pages DS-3 thru DS-4; replace with attached pages Addendum-1-7 and Addendum-1-8.

- Item #5: Detailed Specification for Maintaining Traffic pages DS-7 thru DS-43; replace with attached pages Addendum-1-9 thru Addendum-1-44.
- Item #6: Replace in Appendices Street Crack Treatment List for Phase 2 with pages Addendum-1-45 thru Addendum-1-50.
- Item #7: Include with Appendices Street Crack Treatment Location Maps for Phases 1A and 1B pages Addendum-1-51 and Addendum-1-52.
- Item #8: Include with Appendices Street Crack Treatment Location Maps for Phase 2 - Major Streets and Phase 2 – Minor (Local) Streets pages Addendum-1-53 and Addendum-1-54.

Bidders are responsible for any conclusions that they may draw from the information contained in the Addendum.

Street Crack Treatment – 2017 (ITB No. 4476)

Pre-Bid Conference Agenda

March 20, 2017, 1:30 p.m.
4th Floor Conference Room, City Hall

- I. Introductions
- II. General
 - a. Project Overview

Bid Opening – Wednesday, March 29, 2017, 10:00 a.m.
 - b. Standard Specifications and Detailed Specifications
 - i. Construction Specifications (MDOT 2012 Standard Specifications for Construction)
 - ii. Project Schedule
 - Starting and Completion Dates
 - Phase 1A – May 15 thru June 5, 2017
 - Phase 1B – May 15 thru June 30, 2017
 - Phase 2 – July 1, 2017 thru June 30, 2018
 - Hours of Work: 7:00 am – 8:00 pm Monday thru Saturday (Sundays w/approval)
 - iii. NEW PAY ITEMS – Certified Payroll Compliance and Reporting; Resident Notification
 - c. Payment
- III. Construction
 - a. Project Log/Listing of Locations (Major and Minor/Local streets by phase)
 - b. Overband Crack Fill
 - c. Maintenance of Traffic (lane closures/opening to traffic, local traffic access...)
 - d. Permits (Right-of-Way, Lane Closure(s)...))
 - e. Special Concerns (pedestrian access, notifications to residents/property owners...)
- IV. Addendum Items
- V. Other Items
- VI. Questions

Contact Information:

David Dykman
Project Manager
Phone: (734) 794-6410 ext. 43685
Fax: (734) 994-1744
E-mail: ddykman@a2gov.org

PRE-BID CONFERENCE SIGN-IN SHEET

PROJECT: STREET CRACK TREATMENTS - 2017 (ITB No. 4476)

DATE: 3/20/2017

PLEASE PRINT

NAME	REPRESENTING	MAILING ADDRESS	TELEPHONE	EMAIL
David Dykman Project Manager	City of Ann Arbor - Project Management	Address: <u>301 E. Huron Street, P.O. Box 8647</u> City, State: <u>Ann Arbor, MI</u> Zip: <u>48107-8647</u>	Office: (734) <u>794-6410 ext 43685</u> Mobile: Fax: (734) 994-1744	ddykman@a2gov.org
Gary Shively Civil Engineering Specialist (Project Inspector)	City of Ann Arbor - Project Management	Address: <u>301 E. Huron Street, P.O. Box 8647</u> City, State: <u>Ann Arbor, MI</u> Zip: <u>48107-8647</u>	Office: (734) <u>794-6410 ext 43652</u> Mobile: Fax: (734) 994-1744	gshively@a2gov.org
Chris Rachwal Civil Engineering Specialist (Project Inspector)	City of Ann Arbor - Project Management	Address: <u>301 E. Huron Street, P.O. Box 8647</u> City, State: <u>Ann Arbor, MI</u> Zip: <u>48107-8647</u>	Office: (734) <u>794-6410 ext 43648</u> Mobile: Fax: (734) 994-1744	crachwal@a2gov.org
		Address: _____ City, State: _____ Zip: _____	Office: () _____ Mobile: () _____ Fax No. () _____	
		Address: _____ City, State: _____ Zip: _____	Office: () _____ Mobile: () _____ Fax No. () _____	
		Address: _____ City, State: _____ Zip: _____	Office: () _____ Mobile: () _____ Fax No. () _____	
		Address: _____ City, State: _____ Zip: _____	Office: () _____ Mobile: () _____ Fax No. () _____	
		Address: _____ City, State: _____ Zip: _____	Office: () _____ Mobile: () _____ Fax No. () _____	

BID FORM

Street Crack Treatment - 2017
 File No. 2017-023
 Bid No. 4476

Section 1 - Schedule of Prices

Line No.	Item No.	Item Description	Unit	Estimated Quantity	Unit Price	Total Price
10	1050001	Mobilization, Max. \$20,000.00	LSUM	1.000	\$ _____	\$ _____
20	1047051	_Certified Payroll Compliance and Reporting	LSUM	1.000	\$ _____	\$ _____
30	1047051	_Resident Notification	LSUM	1.000	\$ _____	\$ _____
40	5027004	_Overband Crack Fill, Lane	Lnmi	81.046	\$ _____	\$ _____
50	8127051	_Traffic Control	LSUM	1.000	\$ _____	\$ _____
TOTAL BASE BID					\$ _____	

CITY OF ANN ARBOR
DETAILED SPECIFICATION
FOR
RESIDENT NOTIFICATION

AA:DAD

1 of 1

03/20/17

a. Description. This work consists of notifying in writing all affected residents and/or property/business owners of any proposed crack treatment work on all major and minor (local) City streets, unless otherwise directed by the Engineer. Provide written notification with the following information:

1. Date of notification to affected residents.
2. The nature and duration of the planned work, disruption, and/or closure.
3. Request resident and/or property/business owner not to park on street during the planned work operation.
4. The name, address and telephone numbers of the Contractor, the Engineer, and appropriate City departments.

At the preconstruction meeting or no later than seven (7) business days prior to commencement of any contract work, submit to the Engineer for approval a notification plan (including the proposed written notification).

No construction will begin for work where written notification to is not complete. The Engineer will not give any consideration to claim(s) for contract extension of time resulting from failure to fulfill the requirements of the detailed specification.

b. Materials. None specified.

c. Construction. At least 48 hours in advance of any crack treatment work distribute approved notices to affected residents and/or property/business owners within the planned work limits.

d. Measurement and Payment. The completed work, as described, will be measured and paid for at the contract price for the following pay item:

<u>Pay Item</u>	<u>Pay Unit</u>
Resident Notification	Lump Sum

The contract price includes all preparation, labor, materials, and equipment needed to accomplish this work.

CITY OF ANN ARBOR
DETAILED SPECIFICATION
FOR
PROJECT SCHEDULE

AA:DAD

1 of 2

03/20/17

Complete the entirety of work under this Contract in accordance with, and subject to, the scheduling requirements as outlined below, and all other requirements of the Contract Documents.

The City expects to furnish the Contractor with two (2) copies of the Contract, for its execution, on or before **April 4, 2017**. The Contractor shall properly execute both copies of the Contract and return them, with the required Bonds and Insurance documentation, to the City by **April 21, 2017**. The Contractor shall not begin the work before the applicable date(s) as described herein without approval from the Project Engineer, and in no case before the receipt of the fully executed Contract and Notice to Proceed.

By no later than **April 28, 2017**, the Contractor shall submit a detailed schedule of work (project work schedule) for the Engineer's review and approval. This schedule must fully comply with the scheduling requirements contained in this Detailed Specification, and shall include a beginning date and completion date for each phase of the project. The schedule of streets where crack treatments are to be applied will be in a systematic manner. Once work is started it will continue until all available streets scheduled for crack treatments at that time are complete. Work shall not start until the project work schedule is approved in writing by the Engineer. The Contractor shall update the approved project work schedule each week, unless otherwise as directed by the Engineer.

The Contractor shall begin the work of this project on or before **May 15, 2017**, and only upon receipt of the fully executed Contract and Notice to Proceed. Appropriate time extensions shall be granted if the Notice to Proceed is delayed beyond this date.

Due to the City's fiscal year (FY) budget cycle and approved funding levels, this project is divided into separate phases (1A, 1B, and 2). Phases 1A and 1B cover the remainder of FY 2017. Phase 1A shall be complete by **June 5, 2017**, and Phase 1B shall be complete by **June 30, 2017**. Phase 2 covers FY 2018, and shall begin on or after **July 1, 2017**. Phase 2 and the entire project shall be complete on or before **June 30, 2018**. The City may elect to move streets between the two phases in order to comply with appropriated FY funding amounts.

Failure to complete all work as specified, within the times specified, including time extensions granted thereto as determined by the Engineer, shall entitle the City to deduct from the payments due the Contractor **\$250.00** in "Liquidated Damages", and not as a penalty, for each and every calendar day the work remains incomplete beyond the dates specified. Liquidated Damages will be assessed until the required work is completed in the current construction season. If, with the Engineer's approval, work is extended beyond seasonal limitations, the assessment of Liquidated Damages will be discontinued until the work is resumed in the following construction season.

Time is of the essence in the performance of the work of this Contract. The Contractor is expected to mobilize sufficient personnel and equipment, and work throughout all authorized hours to complete the project by the required completion dates. It is anticipated the Contractor may need to make one or more trips within each phase to complete the work in accordance with the approved project work schedule. The Contractor shall provide a minimum of three (3) working notice to the Engineer prior to mobilizing for each trip. Should the Contractor demonstrate that they must work on some Sundays in order to maintain the project schedule, they may only do so

with prior approval from the City and only during the hours designated by such approval. There will be no additional compensation due to the Contractor for work performed on Sundays.

The Engineer may delay or stop the work due to threatening weather conditions. The Contractor shall not be compensated for unused materials or downtime due to rain, or the threat of rain. The Contractor is solely responsible for repairing all damages to the work and to the site, including road infrastructures, road subgrades, and any adjacent properties, which are caused as a result of working in the rain.

The Contractor shall not work in the dark except as approved by the Engineer and only when lighting for night work is provided as detailed elsewhere in this contract. The Engineer may stop the work, or may require the Contractor to defer certain work to another day, if, in the Engineer's opinion, the work cannot be completed within the remaining daylight hours, or if inadequate daylight is present to either properly perform or inspect the work. The Contractor will not be compensated for unused materials or downtime, when delays or work stoppages are directed by the Engineer for darkness and/or inadequate remaining daylight reasons. The Contractor is solely responsible for repairing all damages to the work and to the site, including road infrastructures, road subgrades, and any adjacent properties, which are caused as a result of working in the dark.

If the construction contract is not completed within the specified period(s) including any extensions of time granted thereto, at the sole discretion of the City of Ann Arbor, this Contract may be terminated with no additional compensation due to the Contractor, and the Contractor may be forbidden to bid on future City of Ann Arbor projects for a period of at least three (3) years. If the Engineer elects to terminate the Contract, contract items paid for on a Lump Sum basis shall be paid up to a maximum percentage equal to the percentage of the contract work that has been completed.

The City's decision to delete streets, add streets, change the construction limits on streets, or, the City's contribution to a delay of the construction on any one street shall not entitle the Contractor to receive additional compensation for work on any other street(s), nor shall it relieve the Contractor of any responsibilities for completion of work on any other street(s).

Costs for the Contractor to organize, coordinate, and schedule all of the project work will not be paid for separately, but shall be included in the bid price of other pay items under the contract.

CITY OF ANN ARBOR
DETAILED SPECIFICATION
FOR
MAINTAINING TRAFFIC

AA:DAD

1 of 6

03/26/17

a. Description. This work consists of maintaining traffic for Street Crack Treatment at locations identified in this project.

b. General. Maintain traffic throughout the project duration in accordance with sections 103 and 812 of the Michigan Department of Transportation (MDOT) 2012 Standard Specifications for Construction, the 2011 Michigan Manual of Uniform Traffic Control Devices (MMUTCD), any MDOT special provisions and supplemental specifications included in the contract documents, as directed by the Engineer, and as herein specified.

1. Notify the Project Engineer a minimum of five (5) working days prior to the implementation of any lane closures.
2. Coordinate this work with any other Contractors and City of Ann Arbor Public Works maintenance crews performing work within the Construction Influence Area or adjoining areas to avoid conflicts in the maintenance of traffic, construction signing, and the orderly progress of contract work.
3. The following, and herein included, MDOT Maintaining Traffic Typicals and Work Zone Device Details apply to the project: M0020a, M0050a, M0140a, M0231a, M0240a, M0270a, M0370a, M0730a, WZD-100-A, and WZD-125-E.
4. These maintaining traffic provisions are subject to change in the event of special community activities.

c. Construction Influence Area (C.I.A.). The C.I.A. includes the area within the City of Ann Arbor right-of-way for each of the street crack treatment locations identified in this project, including that approximately 2,500 feet in advance of and departing the work zone for major streets, and 1,500 feet in advance of and departing the work zone for minor (local) streets. It also includes the rights-of-way of any intersecting streets adjacent to the work zone for a distance noted in signing standards.

d. Materials. Materials for all devices used to temporarily control and maintain traffic shall meet the requirements of section 812 of the MDOT 2012 Standard Specifications for Construction, the MMUTCD, and the applicable MDOT typicals and details included herein.

All signs shall be 48 inches by 48 inches with black edges on reflectorized orange background unless otherwise noted.

Install temporary signs on driven posts, which are to remain in the same place for 14 days or more. Install all other temporary signs on portable supports. All signs shall have a minimum bottom height of 7.0 feet.

Channelizing devices required for all lane closures shall be 42 inch channelizing devices.

e. Construction. Construction methods shall meet the requirements of section 812 of the MDOT 2012 Standard Specifications for Construction.

The Contractor shall furnish and place all necessary temporary traffic control devices to maintain traffic during construction. Keep all work, construction equipment, and material storage behind barricades and/or channelizing devices.

Distances between warning, regulatory, and guide signs as shown on the typical and details are approximate, and may require field adjustment, as directed by the Engineer.

The Contractor shall maintain a minimum of one (1) lane of traffic in each direction at all times utilizing lane closures and/or flag control, whichever is determined appropriate by the Engineer. Minimize traffic delays within intersections and keep them open to traffic for the maximum extent possible unless specifically authorized in writing by the Engineer.

The Contractor shall maintain traffic such that no vehicle shall be required to drive into active work areas.

All temporary traffic/pedestrian control devices furnished by the Contractor shall remain the property of the Contractor. The City shall not be responsible for stolen or damaged signs, barricades, plastic drums and other traffic maintenance items. The Contractor shall replace missing and/or damaged traffic control devices immediately, at no additional cost to the City.

The Contractor shall furnish, erect, maintain, and upon completion of the work, remove all traffic control devices within and around the CIA for the safety and protection of traffic. This includes, but is not limited to, regulatory and warning signs, barricades, channeling devices and other minor devices where required by the Engineer.

The Contractor shall coordinate its operations with all subcontractors, utilities, and/or other contractors performing work on this and other projects within, or adjacent to, the Construction Influence Area (CIA). The contractor shall avoid conflicts in maintaining traffic operations, signing, and orderly progress of other contract work.

The Contractor must submit a work zone traffic control plan to the Engineer in accordance with section 104 of the *2012 Standard Specifications for Construction*. The Engineer will have seven (7) calendar days to review the plan for acceptance or provide comments for plan revisions required to obtain acceptance. At a minimum, the plan shall include the proposed ingress/egress locations for construction equipment and vehicles, traffic control devices that will be utilized to warn the motoring public of ingress/egress locations, and measures that will be taken to ensure compliance with the plan. No work shall begin prior to acceptance of the work zone traffic control plan. Additional time required to obtain an accepted work zone traffic control plan shall not be cause for delay or impact claims. All costs associated with obtaining an acceptable plan, providing and executing all parts of the accepted plan including required traffic control devices, or resolving an incomplete or unacceptable plan shall be borne by the Contractor.

1. Permits. Prior to the start of construction, the Contractor shall obtain a "Right-of-Way" Permit from City of Ann Arbor Customer Services Unit. The Contractor shall notify the Project Engineer and obtain a "Traffic Detour or Lane Closure" Permit from City of Ann Arbor Project Management Services Unit a minimum of 72 business

hours prior to the implementation of any traffic shifts, lane closures and street closures. The fees for these permits will be waived.

2. **Work Times and Restrictions.** All work shall be conducted Monday through Saturday between 7:00am and 8:00pm; unless an alternate plan identifying the days and hours of work has been authorized by the City prior to commencement of construction. Should night work be required for any reason, the Project Engineer must be notified three (3) working days (72 hours) in advance of such work, and the work must have the approval of the City prior to commencement.

Only work of an emergency nature or work required to insure traffic safety shall be performed on Sunday and only with prior approval by the City.

No road work shall be performed nor traffic interruptions be permitted, including lane closures, on Sundays. In addition, no work will be allowed during the Memorial Day, Independence Day, and Labor Day holiday periods, and also during the Ann Arbor Street Art Fairs, which are all defined according to the following table:

Holiday	Start Date	Start Time	End Date	End Time
Memorial Day	Fri, May 26, 2017	3:00 PM	Tue, May 30, 2017	7:00 AM
Memorial Day	Fri, May 25, 2018	3:00 PM	Tue, May 29, 2018	7:00 AM
Independence Day	Mon, July 3, 2017	3:00 PM	Wed, July 5, 2017	7:00 AM
Labor Day	Fri, Sep 1, 2017	3:00 PM	Tue, Sept 5, 2017	7:00 AM
A2 Street Art Fairs	Wed, Jul 22, 2017	8:00 PM	Mon, Jul 24, 2017	7:00 AM

During non-working periods, any area with uncompleted work shall have plastic drums at specific locations and protective fencing, as directed by the Engineer, and at no additional cost to the project.

3. **Traffic Restrictions.** The Contractor shall, at all times, conduct its work to insure the least possible obstruction to traffic and inconvenience to the general public, businesses, and residents in the vicinity of the work.

Traffic on major streets should not be impacted from 7:00 a.m. to 9:00 a.m. and from 3:30 p.m. to 6:00 p.m. unless otherwise approved by the Engineer or as specified on the Lane Closure Permit. All major changes in traffic control shall be made either between 9:00 a.m. and 3:30 p.m. or between 7:00 p.m. and 6:30 a.m. in order to minimize interference with rush hour traffic. All traffic controls must be in place and ready for traffic each day by 6:30 a.m. and 3:30 p.m. Temporary obstruction of traffic for loading and unloading of trucks, and other construction activities, will be permitted with approval from the Engineer if the Contractor provides traffic regulators (flag persons) in conformance with Part VI of the MMUTCD. During temporary obstructions, a minimum of two traffic regulators are required. The cost of traffic regulators (flag control) shall be included in the contract pay item "Traf Regulator Control".

Access to businesses, residences, and side street(s) within the CIA shall be maintained for the duration of the project. The Contractor shall make every effort to coordinate its operations to minimize interruptions impacting this access. The Contractor shall notify the Project Engineer forty-eight (48) hours in advance of any

work to be performed on or near business or residential driveways, and stage work so that it is part-width when it is necessary to work in these areas. Prohibiting access to businesses and residences will not be allowed during any phase of construction, and flagging will be required at the discretion of the Engineer.

Do not place lane closures or traffic regulation sequences where work can be accomplished with a shoulder closure. Place lane closures and traffic regulation operations only in areas and situations deemed necessary by the Engineer.

Do not occupy any part of the active traffic lane when utilizing a shoulder closure with personnel or equipment. Avoid this situation or use a lane closure.

Utilize intermediate traffic regulators at all intersections and driveways with commercial traffic. A large number of intersections and commercial driveways may cause a reduction in the allowable length of lane closures. The cost of additional traffic regulators will be borne by the Contractor.

Cover or remove existing regulatory, warning, and construction signs that are not applicable during construction.

Construction signing that refers to work zone speed shall be covered when work at a location is planned to be inactive for a period greater than two working days or as directed by the Engineer.

A lane closure shall be removed from the through roadway as directed by the Engineer due to inclement weather conditions that would cause an unsafe traffic situation. A lane closure shall not be placed in the through roadway as directed by the Engineer due to inclement weather conditions that would cause an unsafe traffic situation.

Lane width shall be a minimum of 10 feet wide. Contractor shall schedule work so that under no circumstances traffic is stopped. The work within the CIA shall be suspended, during peak traffic hours and/or when traffic is being unduly hampered or delayed by all construction activity, at the discretion of the Engineer.

4. Special Considerations at Railroad Crossings

An intermediate roadway traffic regulator shall be needed at the railroad crossing while it is in the zone where traffic is maintained by traffic regulator control. Every effort should be made by the Contractors' construction methods to not obstruct the right-hand display of the railroad signal to traffic approaching the crossing. The intermediate roadway traffic regulator shall serve to stop traffic for vehicles traveling in the direction opposed to normal flow and prevent them from entering the crossing upon a train approaching the crossing. The Contractor shall place a temporary stop line and sign R1 5-1 (crossbuck) to indicate the stopping point in advance of the crossing for vehicles traveling in a direction opposed to normal flow. The intermediate roadway traffic regulator(s) and temporary stop line(s) are considered incidental to Flag Control and will not be paid for separately.

When the railroad crossing is in the influence zone of active construction work, but not in a lane closure, the roadway traffic regulator shall give immediate preference to

clearing any traffic that backs-up over the crossing as a result of the flagging control away from the crossing.

No lane closure taper(s) may extend through the crossing. Traffic lane shifts cannot transition over the crossing.

No construction traffic control devices and/or work vehicles may be placed in the railroad crossing or closer than 15 ft. from the outside rail on either crossing approach.

- 5. Emergency Services. The Contractor shall notify local police, fire departments and emergency response units a minimum of three business days (72 hours) prior to the closure of any lanes, or traffic shifts causing restricted movements of traffic or restricted access. Fire hydrants in or adjacent to the work shall be kept "live" and fire fighting forces made aware of their availability at all times during construction.

f. Measurement and Payment. The completed work for maintaining traffic, as described, will be paid for at the contract unit price for the following item:

<u>Pay Item</u>	<u>Pay Unit</u>
Traffic Control.....	Lump Sum

The completed work for **Traffic Control**, including all labor, materials, and equipment as required, may include, but may not be limited to, the items listed below as described in section 812 of the 2012 MDOT Standard Specifications for Construction.

The estimated quantities for maintaining traffic shown below are based on the signing and related traffic control devices deemed necessary for this project as shown on the applicable MDOT Maintaining Traffic Typical, and include traffic regulators, lighted arrows and minor traffic devices.

Quantities have been estimated based on the maximum number of signs and other traffic control devices in place at any one time throughout the duration of the project and include 1 (one) single lane closure in a two lane section (signing Typical fig. M0140a), 1 (one) single lane closure on a three lane roadway (signing Typical fig. M0231a), 1 (one) single lane closure on an undivided multi-lane roadway (signing Typical fig. M0240a), closing the 2 (two) center lanes on an undivided multi-lane roadway (signing Typical fig. M0270a), closing the center lane for left turn only and adjacent through lane in each direction on an undivided multi-lane roadway (signing Typical fig. M0370a), 1 (one) single lane closure on a divided roadway (signing Typical fig. M0730a), and signing per Typical figure M0050a. Four additional W20-1 (ROAD WORK AHEAD) signs have been include to accommodate 2 roadway intersections approaching the work area.

Quantities shown for the following work items are estimates for this project and are shown only for informational purposes. The work items are included in the pay item for Traffic Control. Actual quantities used will be as required by the Engineer.

<u>Work Item</u>	<u>Estimated Quantity</u>
Lighted Arrow, Type C, Furn	2 Each
Lighted Arrow, Type C, Oper	2 Each
Channelizing Device, 42 Inch, Furn	250 Each
Channelizing Device, 42 Inch, Oper	250 Each
Sign, Type B, Temp, Oper	320 Square Foot
Sign, Type B, Temp, Furn	320 Square Foot
Minor Traf Devices	1 Lump Sum
Traffic Regulator Control	1 Lump Sum

MINIMUM MERGING TAPER LENGTH "L" (FEET)

OFFSET FEET	POSTED SPEED LIMIT, MPH (PRIOR TO WORK AREA)									
	25	30	35	40	45	50	55	60	65	70
1	10	15	20	27	45	50	55	60	65	70
2	21	30	41	53	90	100	110	120	130	140
3	31	45	61	80	135	150	165	180	195	210
4	42	60	82	107	180	200	220	240	260	280
5	52	75	102	133	225	250	275	300	325	350
6	63	90	123	160	270	300	330	360	390	420
7	73	105	143	187	315	350	385	420	455	490
8	83	120	163	213	360	400	440	480	520	560
9	94	135	184	240	405	450	495	540	585	630
10	104	150	204	267	450	500	550	600	650	700
11	115	165	225	293	495	550	605	660	715	770
12	125	180	245	320	540	600	660	720	780	840
13	135	195	266	347	585	650	715	780	845	910
14	146	210	286	374	630	700	770	840	910	980
15	157	225	307	400	675	750	825	900	975	1050

TAPER LENGTH "L" IN FEET

THE FORMULAS FOR THE MINIMUM LENGTH OF A MERGING TAPER IN DERIVING THE "L" VALUES SHOWN IN THE ABOVE TABLES ARE AS FOLLOWS:

"L" = $\frac{W \times S^2}{60}$ WHERE POSTED SPEED PRIOR TO THE WORK AREA IS 40 MPH OR LESS

"L" = S x W WHERE POSTED SPEED PRIOR TO THE WORK AREA IS 45 MPH OR GREATER

- L = MINIMUM LENGTH OF MERGING TAPER
- S = POSTED SPEED LIMIT IN MPH PRIOR TO WORK AREA
- W = WIDTH OF OFFSET

TYPES OF TAPERS

UPSTREAM TAPERS

- MERGING TAPER
- SHIFTING TAPER
- SHOULDER TAPER
- TWO-WAY TRAFFIC TAPER

DOWNSTREAM TAPERS (USE IS OPTIONAL)

TAPER LENGTH

- L - MINIMUM
- 1/2 L - MINIMUM
- 1/3 L - MINIMUM
- 100' - MAXIMUM
- 100' - MINIMUM (PER LANE)

 TRAFFIC AND SAFETY MAINTAINING TRAFFIC TYPICAL	TABLES FOR "L", "D" AND "B" VALUES		
	DRAWN BY: CON:AE:djf CHECKED BY: BMM	JUNE 2006 PLAN DATE:	M0020a
FILE: K:/DGN/TSR/STDS/ENGLISH/MNTTRF/M0020a.dgn REV. 08/21/2006			

DISTANCE BETWEEN TRAFFIC CONTROL DEVICES "D"
AND LENGTH OF LONGITUDINAL BUFFER SPACE ON
"WHERE WORKERS PRESENT" SEQUENCES

"D" DISTANCES	POSTED SPEED LIMIT, MPH (PRIOR TO WORK AREA)									
	25	30	35	40	45	50	55	60	65	70
D (FEET)	250	300	350	400	450	500	550	600	650	700

GUIDELINES FOR LENGTH OF
LONGITUDINAL BUFFER SPACE "B"

SPEED* MPH	LENGTH FEET
20	33
25	50
30	83
35	132
40	181
45	230
50	279
55	329
60	411
65	476
70	542

* POSTED SPEED, OFF PEAK 85TH PERCENTILE SPEED PRIOR TO WORK STARTING, OR THE ANTICIPATED OPERATING SPEED

1 BASED UPON AMERICAN ASSOCIATION OF STATE HIGHWAY AND TRANSPORTATION OFFICIALS (AASHTO) BRAKING DISTANCE PORTION OF STOPPING SIGHT DISTANCE FOR WET AND LEVEL PAVEMENTS (A POLICY ON GEOMETRIC DESIGN OF HIGHWAY AND STREETS), AASHTO. THIS AASHTO DOCUMENT ALSO RECOMMENDS ADJUSTMENTS FOR THE EFFECT OF GRADE ON STOPPING AND VARIATION FOR TRUCKS.

 Michigan Department of Transportation TRAFFIC AND SAFETY MAINTAINING TRAFFIC TYPICAL	TABLES FOR "L", "D" AND "B" VALUES		
	DRAWN BY: CON:AE:djf CHECKED BY: BMM	JUNE 2006 PLAN DATE:	M0020a
FILE: K:/DGN/TSR/STDS/ENGLISH/MNTTRF/M0020a.dgn REV. 08/21/2006			

SIGN PLACEMENT
IS THE SAME FOR
BOTH DIRECTIONS

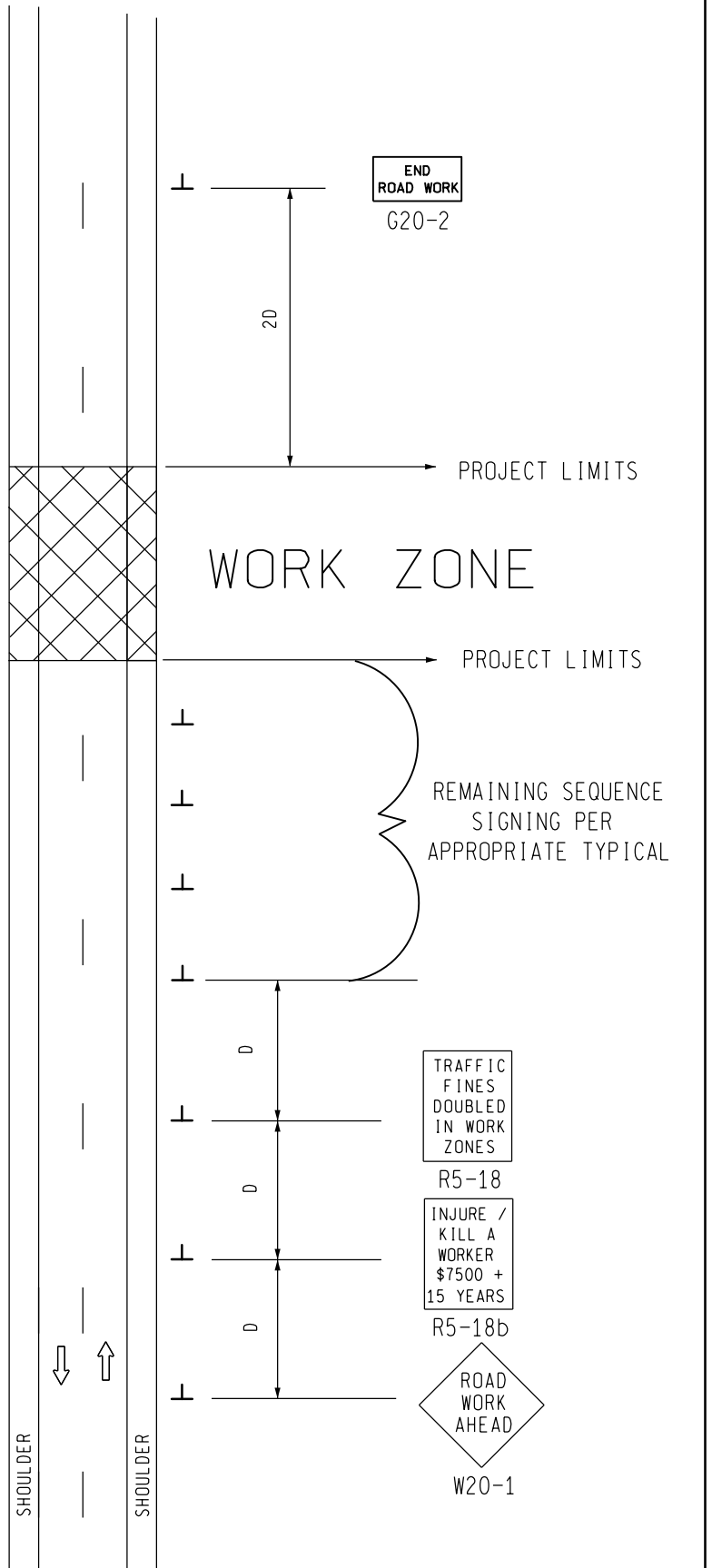
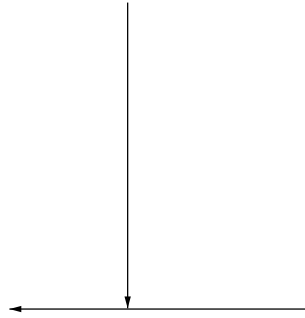

SIGN = 48 f+2 - TYPE B
FOR ONE DIRECTION OF TRAFFIC
W20-1 QUANTITY INCLUDED WITH
APPROPRIATE TYPICAL FOR
SEQUENCE SIGNING

<p>TRAFFIC AND SAFETY MAINTAINING TRAFFIC TYPICAL</p>	<p>TYPICAL ADVANCE SIGNING TREATMENT FOR INTERMEDIATE AND SHORT TERM STATIONARY WORK ZONE OPERATIONS WHERE ALL TRAFFIC CONTROL DEVICES ARE REMOVED AT END OF EACH WORK DAY ON AN UNDIVIDED TWO-WAY ROADWAY</p>	
	<p>DRAWN BY: CON:AE:djf CHECKED BY: BMM:CRB</p>	<p>OCTOBER 2011 PLAN DATE:</p>
<p>FILE: PW RD/TS/Typicals/Signs/MT NON FWY/M0050a.dgn REV. 10/13/2011</p>		

NOT TO SCALE

NOTES

30. THE APPROPRIATE ADVANCE SIGNING SEQUENCE(S), (M0030a THROUGH M0080a) SHALL BE USED ON ALL PROJECTS.
35. THESE SIGNS ARE INTENDED TO BE USED WITHIN THE LIMITS OF THE TEMPORARY SEQUENCE SIGNING AS IS SHOWN ON 1 OF 2. THESE SIGNS ARE NOT TO BE INTERMINGLED WITH ANY OTHER TEMPORARY SEQUENCE SIGNING EXCEPT AS SHOWN.

SIGN SIZES

G20-2	-	48" x 24"
R5-18	-	48" x 60"
R5-18b	-	48" x 60"
W20-1	-	48" x 48"

 MDOT Michigan Department of Transportation TRAFFIC AND SAFETY MAINTAINING TRAFFIC TYPICAL	TYPICAL ADVANCE SIGNING TREATMENT FOR INTERMEDIATE AND SHORT TERM STATIONARY WORK ZONE OPERATIONS WHERE ALL TRAFFIC CONTROL DEVICES ARE REMOVED AT END OF EACH WORK DAY ON AN UNDIVIDED TWO-WAY ROADWAY		
	DRAWN BY: CON:AE:djf	OCTOBER 2011	SHEET
CHECKED BY: BMM:CRB	PLAN DATE:	M0050a	2 OF 2
FILE: PW RD/TS/Typicals/Signs/MT NON FWY/M0050a.dgn REV. 10/13/2011			

NOT TO SCALE





PLACE THROUGHOUT WORK AREA AS INDICATED AND AFTER ALL MAJOR CROSSROADS IF PERMANENT SIGNS ARE NOT IN PLACE.

PLACE THIS SIGN ALONG WITH THE ADVANCE WORK ZONE SIGNING AS DEPICTED ON THE APPROPRIATE TYPICAL M0030a-M0080a.

PLACE THROUGHOUT WORK AREA AS INDICATED AND AFTER ALL MAJOR CROSSROADS IF PERMANENT SIGNS ARE NOT IN PLACE.

PLACE THIS SIGN ALONG WITH THE ADVANCE WORK ZONE SIGNING AS DEPICTED ON THE APPROPRIATE TYPICAL M0030a-M0080a.

KEY

-  TRAFFIC REGULATOR
-  CHANNELIZING DEVICES
-  LIGHTED ARROW PANEL (CAUTION MODE)
-  TRAFFIC FLOW
-  REFLECTS EXISTING SPEED LIMIT

SIGN = 200 ft± - TYPE B PLUS ADDITIONAL R2-1's THROUGHOUT WORK AREA

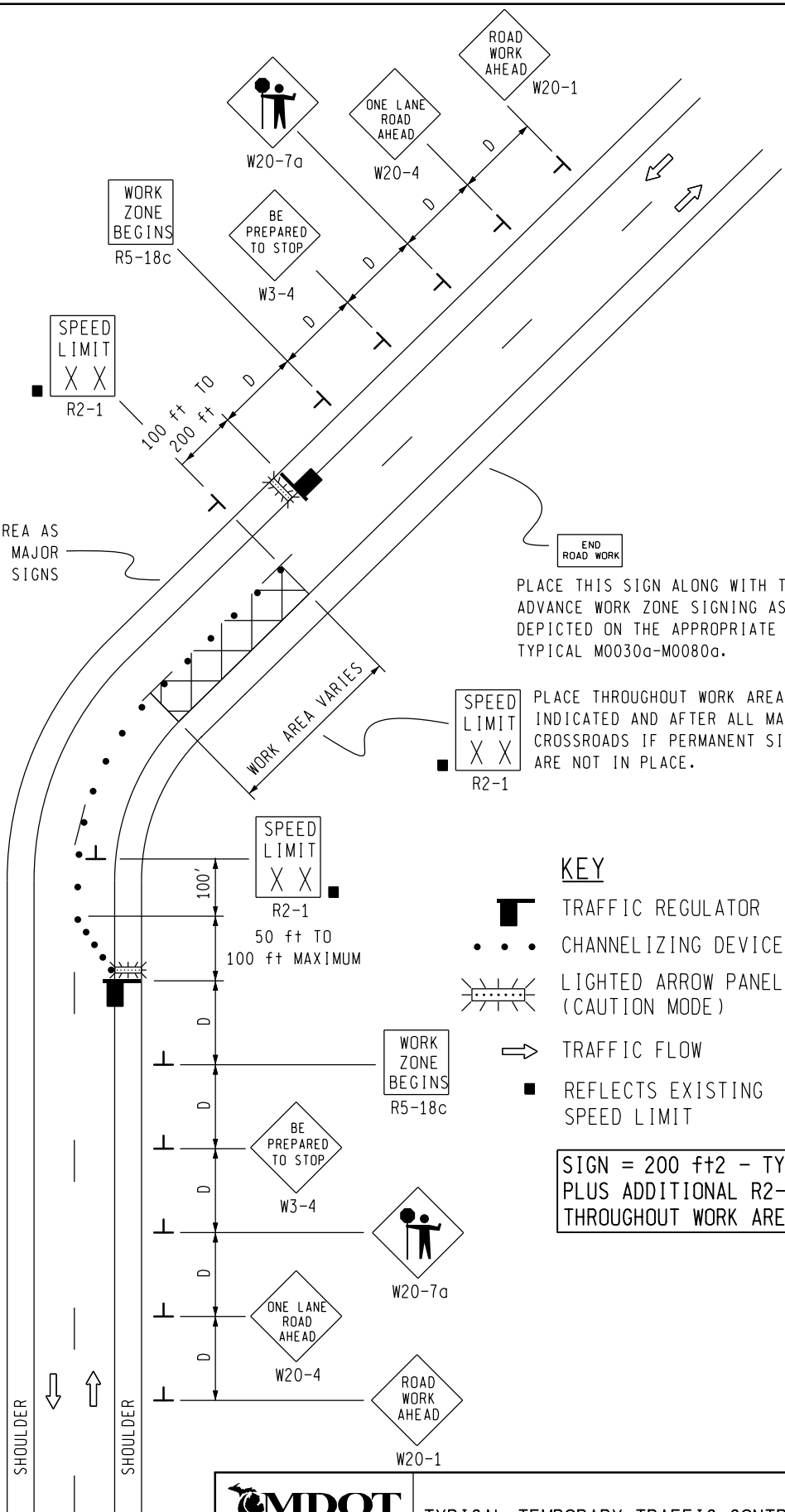

MDOT
Michigan Department of Transportation
TRAFFIC AND SAFETY
MAINTAINING TRAFFIC
TYPICAL

DRAWN BY: CON:AE:djf
CHECKED BY: BMM:CRB

TYPICAL TEMPORARY TRAFFIC CONTROL FOR A TWO-LANE TWO-WAY ROADWAY WHERE ONE LANE IS CLOSED UTILIZING TRAFFIC REGULATORS, NO SPEED REDUCTION

OCTOBER 2011	M0140a	SHEET 1 OF 2
PLAN DATE:		

NOT TO SCALE

NOTES

- 1H. D = DISTANCE BETWEEN TRAFFIC CONTROL DEVICES AND LENGTH OF LONGITUDINAL BUFFERS
SEE **M0020a** FOR "D" VALUES.
2. ALL NON-APPLICABLE SIGNING WITHIN THE CIA SHALL BE MODIFIED TO FIT CONDITIONS, COVERED OR REMOVED.
3. DISTANCES BETWEEN SIGNS, THE VALUES FOR WHICH ARE SHOWN IN TABLE D, ARE APPROXIMATE AND MAY NEED ADJUSTING AS DIRECTED BY THE ENGINEER.
- 3A. THE "WORK ZONE BEGINS" (R5-18c) SIGN SHALL BE USED ONLY IN THE INITIAL SIGNING SEQUENCE IN THE WORK ZONE. SUBSEQUENT SEQUENCES IN THE SAME WORK ZONE SHALL OMIT THIS SIGN AND THE QUANTITIES SHALL BE ADJUSTED APPROPRIATELY.
- 4A. THE MAXIMUM RECOMMENDED DISTANCE(S) BETWEEN CHANNELIZING DEVICES IN THE TAPER AREA(S) SHOULD BE 15 FEET AND SHOULD BE EQUAL IN FEET TO TWICE THE POSTED SPEED IN MILES PER HOUR IN THE PARALLEL AREA(S).
5. FOR OVERNIGHT CLOSURES, TYPE III BARRICADES SHALL BE LIGHTED.
6. WHEN CALLED FOR IN THE FHWA ACCEPTANCE LETTER FOR THE SIGN SYSTEM SELECTED, THE TYPE A WARNING FLASHER, SHOWN ON THE WARNING SIGNS, SHALL BE POSITIONED ON THE SIDE OF THE SIGN NEAREST THE ROADWAY.
7. ALL TEMPORARY SIGNS, TYPE III BARRICADES, THEIR SUPPORT SYSTEMS AND LIGHTING REQUIREMENTS SHALL MEET NCHRP 350 CRASHWORTHLY REQUIREMENTS STIPULATED IN THE CURRENT EDITION OF THE MICHIGAN MANUAL ON UNIFORM TRAFFIC CONTROL DEVICES, THE CURRENT EDITION OF THE STANDARD SPECIFICATIONS FOR CONSTRUCTION, THE STANDARD PLANS AND APPLICABLE SPECIAL PROVISIONS. ONLY DESIGNS AND MATERIALS APPROVED BY MDOT WILL BE ALLOWED.
9. ALL TRAFFIC REGULATORS SHALL BE PROPERLY TRAINED AND SUPERVISED.
- 9A. IN ANY OPERATION INVOLVING MORE THAN ONE TRAFFIC REGULATOR, ONE PERSON SHOULD BE DESIGNATED AS HEAD TRAFFIC REGULATOR.
10. ALL TRAFFIC REGULATORS' CONDUCT, THEIR EQUIPMENT, AND TRAFFIC REGULATING PROCEDURES SHALL CONFORM TO THE CURRENT EDITION OF THE MICHIGAN MANUAL OF UNIFORM TRAFFIC CONTROL DEVICES (MMUTCD) AND THE CURRENT EDITION OF THE MDOT HANDBOOK ENTITLED "TRAFFIC REGULATORS INSTRUCTION MANUAL."
11. WHEN TRAFFIC REGULATING IS ALLOWED DURING THE HOURS OF DARKNESS, APPROPRIATE LIGHTING SHALL BE PROVIDED TO SUFFICIENTLY ILLUMINATE THE TRAFFIC REGULATOR'S STATIONS.
- 12E. THE MAXIMUM DISTANCE BETWEEN THE TRAFFIC REGULATORS SHALL BE NO MORE THAN 2 MILES IN LENGTH UNLESS RESTRICTED FURTHER IN THE SPECIAL PROVISIONS FOR MAINTAINING TRAFFIC. ALL SEQUENCES OF MORE THAN 2 MILES IN LENGTH WILL REQUIRE WRITTEN PERMISSION FROM THE ENGINEER BEFORE PROCEEDING.
13. WHEN INTERSECTING ROADS OR SIGNIFICANT TRAFFIC GENERATORS (SHOPPING CENTERS, MOBILE HOME PARKS, ETC.) OCCUR WITHIN THE ONE-LANE TWO-WAY OPERATION, INTERMEDIATE TRAFFIC REGULATORS AND APPROPRIATE SIGNING SHALL BE PLACED AT THESE LOCATIONS.
14. ADDITIONAL SIGNING AND/OR ELONGATED SIGNING SEQUENCES SHOULD BE USED WHEN TRAFFIC VOLUMES ARE SIGNIFICANT ENOUGH TO CREATE BACKUPS BEYOND THE W3-4 SIGNS.
15. THE HAND HELD (PADDLE) SIGNS REQUIRED BY THE MMUTCD TO CONTROL TRAFFIC WILL BE PAID FOR AS PART OF FLAG CONTROL.
- 28E. THE TRAFFIC REGULATORS SHOULD BE POSITIONED AT OR NEAR THE SIDE OF THE ROAD SO THAT THEY ARE SEEN CLEARLY AT A MINIMUM DISTANCE OF 500 FEET. THIS MAY REQUIRE EXTENDING THE BEGINNING OF THE LANE CLOSURE TO OVERCOME VIEWING PROBLEMS CAUSED BY HILLS AND CURVES.

SIGN SIZES

DIAMOND WARNING - 48" x 48"
 R2-1 REGULATORY - 48" x 60"
 R5-18c REGULATORY - 48" x 48"

NOT TO SCALE

 Michigan Department of Transportation TRAFFIC AND SAFETY MAINTAINING TRAFFIC TYPICAL	TYPICAL TEMPORARY TRAFFIC CONTROL FOR A TWO-LANE TWO-WAY ROADWAY WHERE ONE LANE IS CLOSED UTILIZING TRAFFIC REGULATORS, NO SPEED REDUCTION		
DRAWN BY: CON:AE:djf	OCTOBER 2011	M0140a	
CHECKED BY: BMM:CRB	PLAN DATE:		
FILE: PW RD/TS/Typicals/Signs/MT NON FWY/M0140a.dgn REV. 10/04/2011			

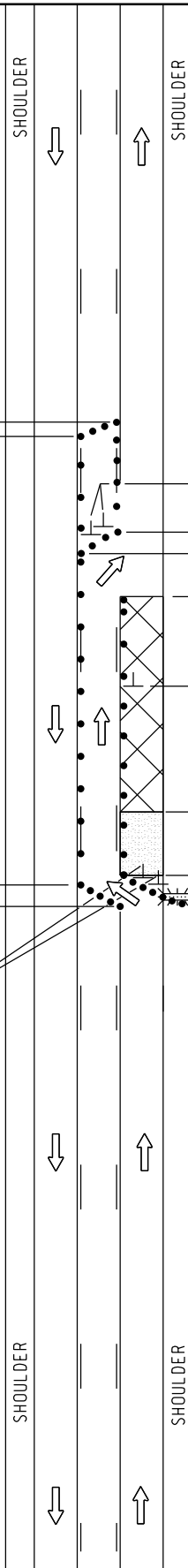
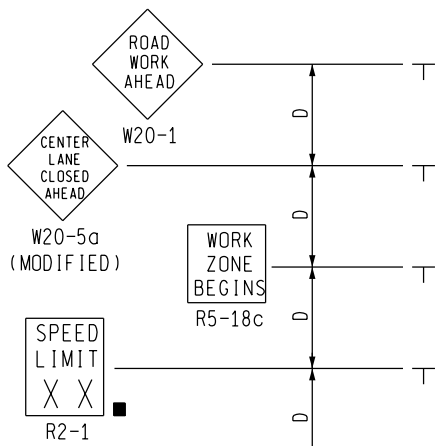

END ROAD WORK

PLACE THIS SIGN ALONG WITH THE ADVANCE WORK ZONE SIGNING AS DEPICTED ON THE APPROPRIATE TYPICAL M0030a-M0050a.

SPEED LIMIT XX R2-1

PLACE THROUGHOUT WORK AREA AS INDICATED AND AFTER ALL MAJOR CROSSROADS IF PERMANENT SIGNS ARE NOT IN PLACE.

WORK AREA VARIES

W1-4

SPEED LIMIT XX R2-1

PLACE THROUGHOUT WORK AREA AS INDICATED AND AFTER ALL MAJOR CROSSROADS IF PERMANENT SIGNS ARE NOT IN PLACE.

END ROAD WORK

PLACE THIS SIGN ALONG WITH THE ADVANCE WORK ZONE SIGNING AS DEPICTED ON THE APPROPRIATE TYPICAL M0030a-M0050a.

KEY

- • • CHANNELIZING DEVICES
- ⚡ LIGHTED ARROW PANEL (CAUTION MODE)
- ➡ TRAFFIC FLOW
- REFLECTS EXISTING SPEED LIMIT

SIGN = 184 ft± - TYPE B PLUS ADDITIONAL R2-1's THROUGHOUT WORK AREA

NOT TO SCALE

MDOT
Michigan Department of Transportation

TRAFFIC AND SAFETY
MAINTAINING TRAFFIC
TYPICAL

DRAWN BY: CON:AE:DJF
CHECKED BY: BMM:CRB

TYPICAL TEMPORARY TRAFFIC CONTROL FOR CLOSING ONE LANE OF A THREE LANE ROADWAY WITH CLFLT0 AND SHIFTING ONE THROUGH LANE INTO THE CLFLT0 NO SPEED REDUCTION

<p>OCTOBER 2011 PLAN DATE:</p>	<p>M0231a</p>	<p>SHEET 1 OF 2</p>
<p>FILE: PW: RD/T&S/Typicals/Signs/MT/MT nonFwy/M0231a REV. 10/18/2011</p>		

NOTES

- 1F. D = DISTANCE BETWEEN TRAFFIC CONTROL DEVICES
 $1/2 L$, AND $1/3 L$ = MINIMUM LENGTH OF TAPER
 B = LENGTH OF LONGITUDINAL BUFFER
 SEE M0020a FOR "D," "L," AND "B" VALUES
2. ALL NON-APPLICABLE SIGNING WITHIN THE CIA SHALL BE MODIFIED TO FIT CONDITIONS, COVERED OR REMOVED.
3. DISTANCES BETWEEN SIGNS, THE VALUES FOR WHICH ARE SHOWN IN TABLE D, ARE APPROXIMATE AND MAY NEED ADJUSTING AS DIRECTED BY THE ENGINEER.
- 3A. THE "WORK ZONE BEGINS" (R5-18c) SIGN SHALL BE USED ONLY IN THE INITIAL SIGNING SEQUENCE IN THE WORK ZONE. SUBSEQUENT SEQUENCES IN THE SAME WORK ZONE SHALL OMIT THIS SIGN AND THE QUANTITIES SHALL BE ADJUSTED APPROPRIATELY.
- 4E. THE MAXIMUM RECOMMENDED DISTANCE(S) BETWEEN CHANNELIZING DEVICES SHOULD BE EQUAL IN FEET TO THE POSTED SPEED IN MILES PER HOUR ON TAPER(S) AND TWICE THE POSTED SPEED IN THE PARALLEL AREA(S).
5. FOR OVERNIGHT CLOSURES, TYPE III BARRICADES SHALL BE LIGHTED.
6. THE TYPE A WARNING FLASHER SHOWN ON THE WARNING SIGNS SHALL BE POSITIONED ON THE SIDE OF THE SIGN NEAREST THE ROADWAY.
7. ALL TEMPORARY SIGNS, TYPE III BARRICADES, THEIR SUPPORT SYSTEMS AND LIGHTING REQUIREMENTS SHALL MEET NCHRP 350 CRASHWORTHY REQUIREMENTS STIPULATED IN THE CURRENT EDITION OF THE MICHIGAN MANUAL ON UNIFORM TRAFFIC CONTROL DEVICES, THE CURRENT EDITION OF THE STANDARD SPECIFICATIONS FOR CONSTRUCTION, THE STANDARD PLANS AND APPLICABLE SPECIAL PROVISIONS. ONLY DESIGNS AND MATERIALS APPROVED BY MDOT WILL BE ALLOWED.
8. WHEN BUFFER AREAS ARE ESTABLISHED, THERE SHALL BE NO EQUIPMENT OR MATERIALS STORED OR WORK CONDUCTED IN THE BUFFER AREA.
21. ALL EXISTING PAVEMENT MARKINGS WHICH ARE IN CONFLICT WITH EITHER PROPOSED CHANGES IN TRAFFIC PATTERNS OR PROPOSED TEMPORARY TRAFFIC MARKINGS, SHALL BE REMOVED BEFORE ANY CHANGE IS MADE IN THE TRAFFIC PATTERN. EXCEPTION WILL BE MADE FOR DAYTIME-ONLY TRAFFIC PATTERNS THAT ARE ADEQUATELY DELINEATED BY OTHER TRAFFIC CONTROL DEVICES.

SIGN SIZES

DIAMOND WARNING	- 48" x 48"
W1-6 WARNING	- 48" x 24"
R2-1 REGULATORY	- 48" x 60"
R5-18c REGULATORY	- 48" x 48"

NOT TO SCALE

 TRAFFIC AND SAFETY MAINTAINING TRAFFIC TYPICAL	TYPICAL TEMPORARY TRAFFIC CONTROL FOR CLOSING ONE LANE OF A THREE LANE ROADWAY WITH CLFLTO AND SHIFTING ONE THROUGH LANE INTO THE CLFLTO NO SPEED REDUCTION	
	DRAWN BY: CON:AE:DJF	OCTOBER 2011
CHECKED BY: BMM:CRB	PLAN DATE:	2 OF 2
FILE: PW: RD/T&S/Typicals/Signs/MT/MT nonFwy/M0231a REV. 10/18/2011		

KEY

- • • CHANNELIZING DEVICES
- ⚡ LIGHTED ARROW PANEL
- ➡ TRAFFIC FLOW
- REFLECTS EXISTING SPEED LIMIT

SIGN = 136 ft±2 - TYPE B PLUS ADDITIONAL R2-1's THROUGHOUT WORK AREA

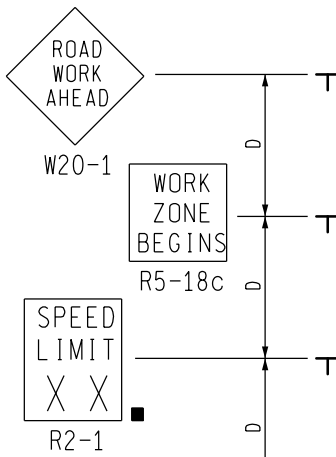

PLACE THIS SIGN ALONG WITH THE ADVANCE WORK ZONE SIGNING AS DEPICTED ON THE APPROPRIATE TYPICAL M0030a-M0080a.



PLACE THROUGHOUT WORK AREA AS INDICATED AND AFTER ALL MAJOR CROSSROADS IF PERMANENT SIGNS ARE NOT IN PLACE.



PLACE THROUGHOUT WORK AREA AS INDICATED AND AFTER ALL CROSSROADS IF PERMANENT SIGNS ARE NOT IN PLACE.

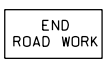

PLACE THIS SIGN ALONG WITH THE ADVANCE WORK ZONE SIGNING AS DEPICTED ON THE APPROPRIATE TYPICAL M0030a-M0080a.

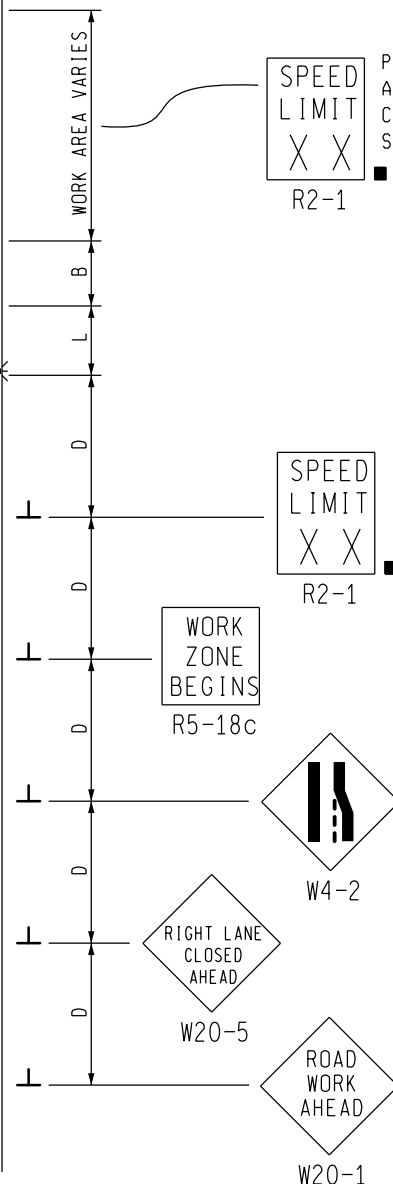
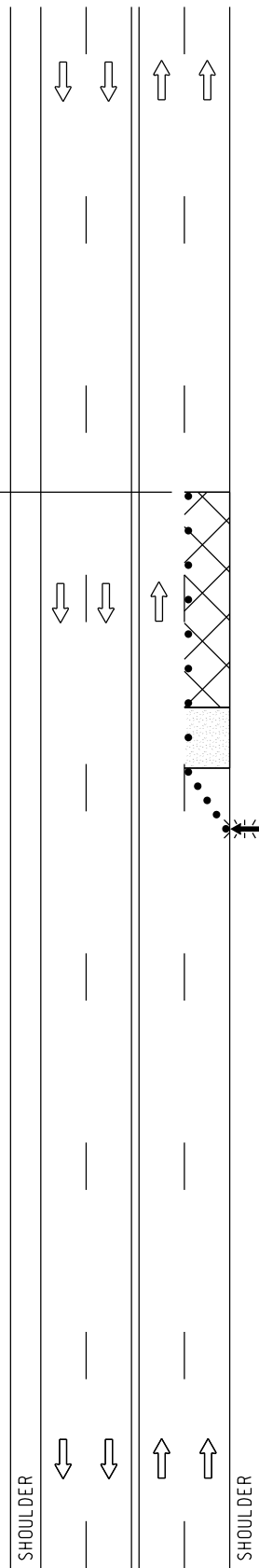

MDOT
Michigan Department of Transportation
TRAFFIC AND SAFETY
MAINTAINING TRAFFIC
TYPICAL

TYPICAL TEMPORARY TRAFFIC CONTROL
FOR A ONE-LANE CLOSURE ON AN
UNDIVIDED MULTI-LANE ROADWAY,
NO SPEED REDUCTION

DRAWN BY: CON:AE:djf	OCTOBER 2011	M0240a	SHEET 1 OF 2
CHECKED BY: BMM:CRB	PLAN DATE:		
FILE: PW RD/TS/Typicals/Signs/MT NON FWY/M0240a.dgn REV. 10/11/2011			

NOT TO SCALE

NOTES

- 1B. D = DISTANCE BETWEEN TRAFFIC CONTROL DEVICES
L = MINIMUM LENGTH OF TAPER
B = LENGTH OF LONGITUDINAL BUFFER
SEE **M0020a** FOR "D," "L," AND "B" VALUES
2. ALL NON-APPLICABLE SIGNING WITHIN THE CIA SHALL BE MODIFIED TO FIT CONDITIONS, COVERED OR REMOVED.
3. DISTANCES BETWEEN SIGNS, THE VALUES FOR WHICH ARE SHOWN IN TABLE D, ARE APPROXIMATE AND MAY NEED ADJUSTING AS DIRECTED BY THE ENGINEER.
- 3A. THE "WORK ZONE BEGINS" (R5-18c) SIGN SHALL BE USED ONLY IN THE INITIAL SIGNING SEQUENCE IN THE WORK ZONE. SUBSEQUENT SEQUENCES IN THE SAME WORK ZONE SHALL OMIT THIS SIGN AND THE QUANTITIES SHALL BE ADJUSTED APPROPRIATELY.
- 4E. THE MAXIMUM RECOMMENDED DISTANCE(S) BETWEEN CHANNELIZING DEVICES SHOULD BE EQUAL IN FEET TO THE POSTED SPEED IN MILES PER HOUR ON TAPER(S) AND TWICE THE POSTED SPEED IN THE PARALLEL AREA(S).
5. FOR OVERNIGHT CLOSURES, TYPE III BARRICADES SHALL BE LIGHTED.
6. WHEN CALLED FOR IN THE FHWA ACCEPTANCE LETTER FOR THE SIGN SYSTEM SELECTED, THE TYPE A WARNING FLASHER, SHOWN ON THE WARNING SIGNS, SHALL BE POSITIONED ON THE SIDE OF THE SIGN NEAREST THE ROADWAY.
7. ALL TEMPORARY SIGNS, TYPE III BARRICADES, THEIR SUPPORT SYSTEMS AND LIGHTING REQUIREMENTS SHALL MEET NCHRP 350 CRASHWORTHLY REQUIREMENTS STIPULATED IN THE CURRENT EDITION OF THE MICHIGAN MANUAL ON UNIFORM TRAFFIC CONTROL DEVICES, THE CURRENT EDITION OF THE STANDARD SPECIFICATIONS FOR CONSTRUCTION, THE STANDARD PLANS AND APPLICABLE SPECIAL PROVISIONS. ONLY DESIGNS AND MATERIALS APPROVED BY MDOT WILL BE ALLOWED.
8. WHEN BUFFER AREAS ARE ESTABLISHED, THERE SHALL BE NO EQUIPMENT OR MATERIALS STORED OR WORK CONDUCTED IN THE BUFFER AREA.
21. ALL EXISTING PAVEMENT MARKINGS WHICH ARE IN CONFLICT WITH EITHER PROPOSED CHANGES IN TRAFFIC PATTERNS OR PROPOSED TEMPORARY TRAFFIC MARKINGS, SHALL BE REMOVED BEFORE ANY CHANGE IS MADE IN THE TRAFFIC PATTERN. EXCEPTION WILL BE MADE FOR DAYTIME-ONLY TRAFFIC PATTERNS THAT ARE ADEQUATELY DELINEATED BY OTHER TRAFFIC CONTROL DEVICES.
26. THE LIGHTED ARROW PANEL SHALL BE LOCATED AT THE BEGINNING OF THE TAPER AS SHOWN. WHEN PHYSICAL LIMITATIONS RESTRICT ITS PLACEMENT AS INDICATED, THEN IT SHALL BE PLACED AS CLOSE TO THE BEGINNING OF THE TAPER AS POSSIBLE.

SIGN SIZES

DIAMOND WARNING - 48" x 48"
 R2-1 REGULATORY - 48" x 60"
 R5-18c REGULATORY - 48" x 48"

NOT TO SCALE

 TRAFFIC AND SAFETY MAINTAINING TRAFFIC TYPICAL		TYPICAL TEMPORARY TRAFFIC CONTROL FOR A ONE-LANE CLOSURE ON AN UNDIVIDED MULTI-LANE ROADWAY, NO SPEED REDUCTION	
DRAWN BY: CON:AE:djf	OCTOBER 2011	M0240a	SHEET
CHECKED BY: BMM:CRB	PLAN DATE:		2 OF 2
FILE: PW RD/TS/Typicals/Signs/MT NON FWY/M0240a.dgn REV. 10/11/2011			

KEY

- • • CHANNELIZING DEVICES
- ← LIGHTED ARROW PANEL
- TRAFFIC FLOW
- REFLECTS EXISTING SPEED LIMIT

SIGN = 168 ft² - TYPE B PLUS ADDITIONAL R2-1s THROUGHOUT WORK AREA.

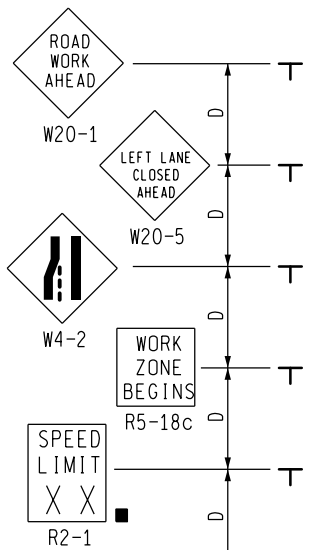

END ROAD WORK
PLACE THIS SIGN ALONG WITH THE ADVANCE WORK ZONE SIGNING AS DEPICTED ON THE APPROPRIATE TYPICAL M0030a-M0080a.

PLACE THROUGHOUT WORK AREA AS INDICATED AND AFTER ALL MAJOR CROSSROADS IF PERMANENT SIGNS ARE NOT IN PLACE.

PLACE THROUGHOUT WORK AREA AS INDICATED AND AFTER ALL MAJOR CROSSROADS IF PERMANENT SIGNS ARE NOT IN PLACE.

END ROAD WORK
PLACE THIS SIGN ALONG WITH THE ADVANCE WORK ZONE SIGNING AS DEPICTED ON THE APPROPRIATE TYPICAL M0030a-M0080a.

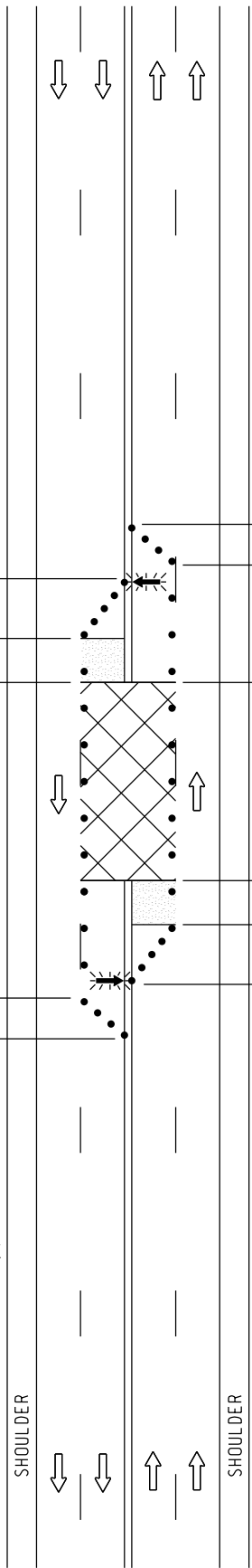

100 ft MINIMUM

WORK AREA VARIES

100 ft MINIMUM

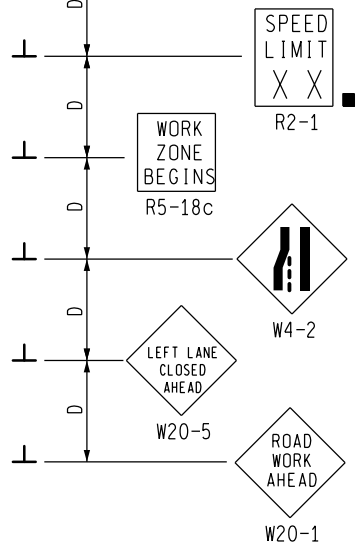

MDOT
Michigan Department of Transportation
TRAFFIC AND SAFETY
MAINTAINING TRAFFIC
TYPICAL

TYPICAL TEMPORARY TRAFFIC CONTROL FOR CLOSING THE CENTER TWO LANES OF A MULTI-LANE UNDIVIDED ROADWAY, (NO CLFLTO) NO SPEED REDUCTION

DRAWN BY: CON:AE:djf
CHECKED BY: BMM:CRB

OCTOBER 2011
PLAN DATE:

M0270a

SHEET 1 OF 2

NOT TO SCALE

FILE: PW RD/TS/Typicals/Signs/MT NON FWY/M0270a.dgn REV. 10/12/2011

Addendum-1-25

NOTES

- 1B. D = DISTANCE BETWEEN TRAFFIC CONTROL DEVICES
L = MINIMUM LENGTH OF TAPER
B = LENGTH OF LONGITUDINAL BUFFER
SEE M0020a FOR "D," "L," AND "B" VALUES
2. ALL NON-APPLICABLE SIGNING WITHIN THE CIA SHALL BE MODIFIED TO FIT CONDITIONS, COVERED OR REMOVED.
3. DISTANCES BETWEEN SIGNS, THE VALUES FOR WHICH ARE SHOWN IN TABLE D, ARE APPROXIMATE AND MAY NEED ADJUSTING AS DIRECTED BY THE ENGINEER.
- 3A. THE "WORK ZONE BEGINS" (R5-18c) SIGN SHALL BE USED ONLY IN THE INITIAL SIGNING SEQUENCE IN THE WORK ZONE. SUBSEQUENT SEQUENCES IN THE SAME WORK ZONE SHALL OMIT THIS SIGN AND THE QUANTITIES SHALL BE ADJUSTED APPROPRIATELY.
- 4B. THE MAXIMUM RECOMMENDED DISTANCE(S) BETWEEN CHANNELIZING DEVICES SHOULD BE EQUAL IN FEET TO THE POSTED SPEED IN MILES PER HOUR ON MERGING TAPER(S), TWICE THE POSTED SPEED IN THE PARALLEL AREA(S), AND 25 FEET IN THE DOWNSTREAM TAPER AREA(S).
5. FOR OVERNIGHT CLOSURES, TYPE III BARRICADES SHALL BE LIGHTED.
6. WHEN CALLED FOR IN THE FHWA ACCEPTANCE LETTER FOR THE SIGN SYSTEM SELECTED, THE TYPE A WARNING FLASHER, SHOWN ON THE WARNING SIGNS, SHALL BE POSITIONED ON THE SIDE OF THE SIGN NEAREST THE ROADWAY.
7. ALL TEMPORARY SIGNS, TYPE III BARRICADES, THEIR SUPPORT SYSTEMS AND LIGHTING REQUIREMENTS SHALL MEET NCHRP 350 CRASHWORTHLY REQUIREMENTS STIPULATED IN THE CURRENT EDITION OF THE MICHIGAN MANUAL ON UNIFORM TRAFFIC CONTROL DEVICES, THE CURRENT EDITION OF THE STANDARD SPECIFICATIONS FOR CONSTRUCTION, THE STANDARD PLANS AND APPLICABLE SPECIAL PROVISIONS. ONLY DESIGNS AND MATERIALS APPROVED BY MDOT WILL BE ALLOWED.
8. WHEN BUFFER AREAS ARE ESTABLISHED, THERE SHALL BE NO EQUIPMENT OR MATERIALS STORED OR WORK CONDUCTED IN THE BUFFER AREA.
21. ALL EXISTING PAVEMENT MARKINGS WHICH ARE IN CONFLICT WITH EITHER PROPOSED CHANGES IN TRAFFIC PATTERNS OR PROPOSED TEMPORARY TRAFFIC MARKINGS, SHALL BE REMOVED BEFORE ANY CHANGE IS MADE IN THE TRAFFIC PATTERN. EXCEPTION WILL BE MADE FOR DAYTIME-ONLY TRAFFIC PATTERNS THAT ARE ADEQUATELY DELINEATED BY OTHER TRAFFIC CONTROL DEVICES.
- 26C. THE LIGHTED ARROW PANEL SHALL BE LOCATED AT THE BEGINNING OF THE MERGING TAPER AS SHOWN. WHEN PHYSICAL LIMITATIONS RESTRICT ITS PLACEMENT AS INDICATED, THEN IT SHALL BE PLACED AS CLOSE TO THE BEGINNING OF THE MERGING TAPER AS POSSIBLE.

SIGN SIZES

DIAMOND WARNING - 48 " x 48 "
R2-1 REGULATORY - 48 " x 60 "
R5-18c REGULATORY - 48 " x 48 "

NOT TO SCALE

 TRAFFIC AND SAFETY MAINTAINING TRAFFIC TYPICAL	TYPICAL TEMPORARY TRAFFIC CONTROL FOR CLOSING THE CENTER TWO LANES OF A MULTI-LANE UNDIVIDED ROADWAY, (NO CLFLTO) NO SPEED REDUCTION		
	DRAWN BY: CON:AE:djf	OCTOBER 2011	M0270a
CHECKED BY: BMM:CRB	PLAN DATE:	2 OF 2	
FILE: PW RD/TS/Typicals/Signs/MT NON FWY/M0270a.dgn REV. 10/12/2011			

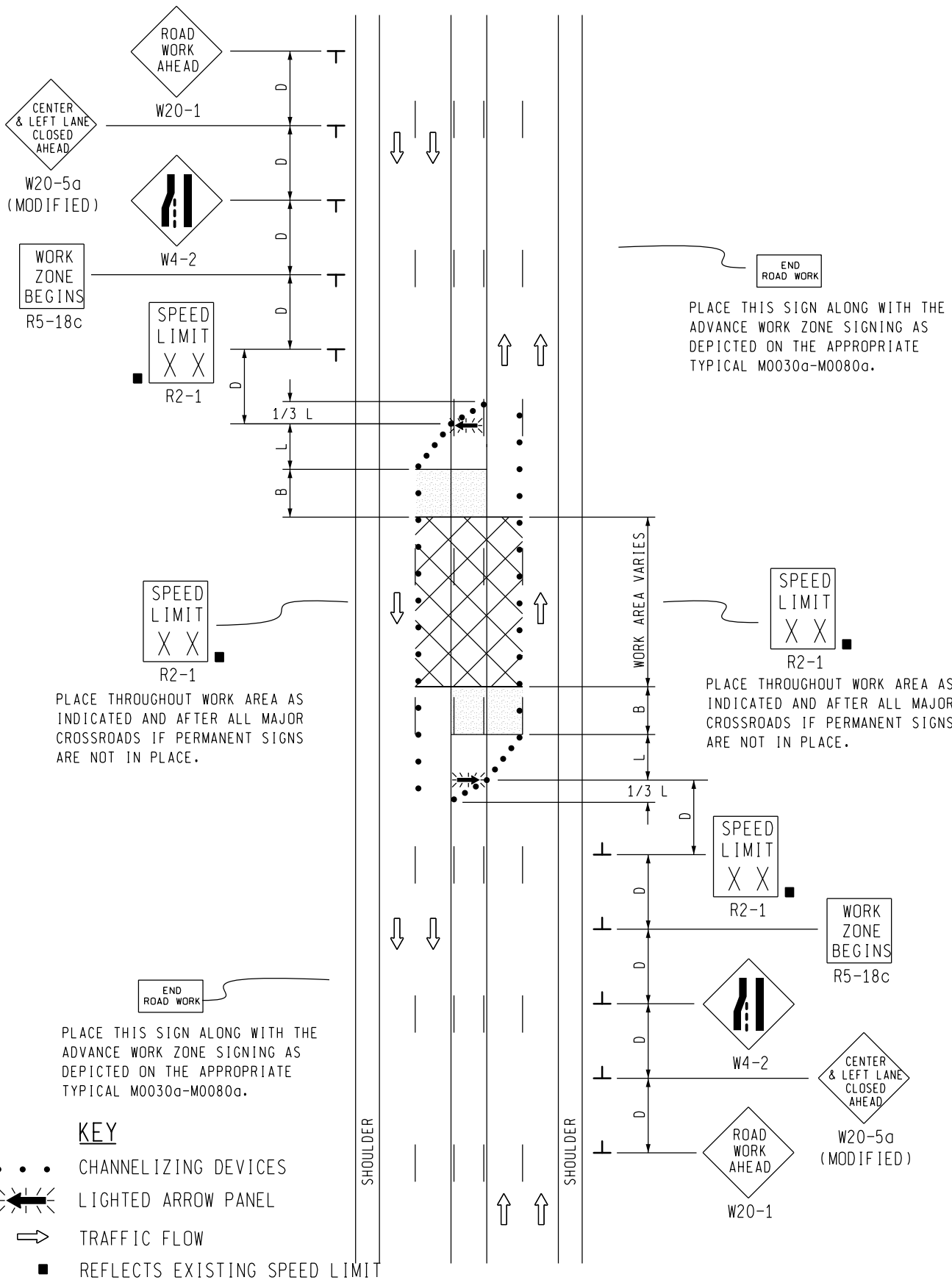

NOT TO SCALE

<p>TRAFFIC AND SAFETY MAINTAINING TRAFFIC TYPICAL</p>		<p>TYPICAL TEMPORARY TRAFFIC CONTROL FOR CLOSING A CENTER-LANE FOR LEFT TURN ONLY AND AN ADJACENT THROUGH LANE IN EACH DIRECTION ON A MULTI-LANE UNDIVIDED ROADWAY, NO SPEED REDUCTION</p>	
<p>DRAWN BY: CON:AE:djf CHECKED BY: BMM:CRB</p>	<p>OCTOBER 2011 PLAN DATE:</p>	<p>M0370a</p>	<p>SHEET 1 OF 2</p>
<p>FILE: PW RD/TS/Typicals/Signs/MT NON FWY/M0370a.dgn REV. 10/18/2011</p>			

NOTES

- 1D. D = DISTANCE BETWEEN TRAFFIC CONTROL DEVICES
L & 1/3 L = MINIMUM LENGTH OF TAPER
B = LENGTH OF LONGITUDINAL BUFFER
SEE **M0020a** FOR "D," "L," AND "B" VALUES
2. ALL NON-APPLICABLE SIGNING WITHIN THE CIA SHALL BE MODIFIED TO FIT CONDITIONS, COVERED OR REMOVED.
3. DISTANCES BETWEEN SIGNS, THE VALUES FOR WHICH ARE SHOWN IN TABLE D, ARE APPROXIMATE AND MAY NEED ADJUSTING AS DIRECTED BY THE ENGINEER.
- 3A. THE "WORK ZONE BEGINS" (R5-18c) SIGN SHALL BE USED ONLY IN THE INITIAL SIGNING SEQUENCE IN THE WORK ZONE. SUBSEQUENT SEQUENCES IN THE SAME WORK ZONE SHALL OMIT THIS SIGN AND THE QUANTITIES SHALL BE ADJUSTED APPROPRIATELY.
- 4E. THE MAXIMUM RECOMMENDED DISTANCE(S) BETWEEN CHANNELIZING DEVICES SHOULD BE EQUAL IN FEET TO THE POSTED SPEED IN MILES PER HOUR ON TAPER(S) AND TWICE THE POSTED SPEED IN THE PARALLEL AREA(S).
5. FOR OVERNIGHT CLOSURES, TYPE III BARRICADES SHALL BE LIGHTED.
6. WHEN CALLED FOR IN THE FHWA ACCEPTANCE LETTER FOR THE SIGN SYSTEM SELECTED, THE TYPE A WARNING FLASHER, SHOWN ON THE WARNING SIGNS, SHALL BE POSITIONED ON THE SIDE OF THE SIGN NEAREST THE ROADWAY.
7. ALL TEMPORARY SIGNS, TYPE III BARRICADES, THEIR SUPPORT SYSTEMS AND LIGHTING REQUIREMENTS SHALL MEET NCHRP 350 CRASHWORTHLY REQUIREMENTS STIPULATED IN THE CURRENT EDITION OF THE MICHIGAN MANUAL ON UNIFORM TRAFFIC CONTROL DEVICES, THE CURRENT EDITION OF THE STANDARD SPECIFICATIONS FOR CONSTRUCTION, THE STANDARD PLANS AND APPLICABLE SPECIAL PROVISIONS. ONLY DESIGNS AND MATERIALS APPROVED BY MDOT WILL BE ALLOWED.
8. WHEN BUFFER AREAS ARE ESTABLISHED, THERE SHALL BE NO EQUIPMENT OR MATERIALS STORED OR WORK CONDUCTED IN THE BUFFER AREA.
21. ALL EXISTING PAVEMENT MARKINGS WHICH ARE IN CONFLICT WITH EITHER PROPOSED CHANGES IN TRAFFIC PATTERNS OR PROPOSED TEMPORARY TRAFFIC MARKINGS, SHALL BE REMOVED BEFORE ANY CHANGE IS MADE IN THE TRAFFIC PATTERN. EXCEPTION WILL BE MADE FOR DAYTIME-ONLY TRAFFIC PATTERNS THAT ARE ADEQUATELY DELINEATED BY OTHER TRAFFIC CONTROL DEVICES.
- 26C. THE LIGHTED ARROW PANEL SHALL BE LOCATED AT THE BEGINNING OF THE MERGING TAPER AS SHOWN. WHEN PHYSICAL LIMITATIONS RESTRICT ITS PLACEMENT AS INDICATED, THEN IT SHALL BE PLACED AS CLOSE TO THE BEGINNING OF THE MERGING TAPER AS POSSIBLE.

SIGN SIZES

DIAMOND WARNING - 48" x 48"
 R2-1 REGULATORY - 48" x 60"
 R5-18c REGULATORY - 48" x 48"

NOT TO SCALE

 TRAFFIC AND SAFETY MAINTAINING TRAFFIC TYPICAL	TYPICAL TEMPORARY TRAFFIC CONTROL FOR CLOSING A CENTER-LANE FOR LEFT TURN ONLY AND AN ADJACENT THROUGH LANE IN EACH DIRECTION ON A MULTI-LANE UNDIVIDED ROADWAY, NO SPEED REDUCTION	
	DRAWN BY: CON:AE:djf CHECKED BY: BMM:CRB	OCTOBER 2011 PLAN DATE:
FILE: PW RD/TS/Typicals/Signs/MT NON FWY/M0370a.dgn REV. 10/18/2011		

END ROAD WORK

PLACE THIS SIGN ALONG WITH THE ADVANCE WORK ZONE SIGNING AS DEPICTED ON THE APPROPRIATE TYPICAL M0030a-M0080a.

END ROAD WORK

PLACE THIS SIGN ALONG WITH THE ADVANCE WORK ZONE SIGNING AS DEPICTED ON THE APPROPRIATE TYPICAL M0030a-M0080a.

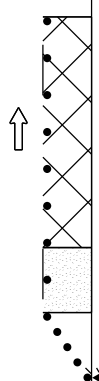

SPEED LIMIT
X X

R2-1

PLACE THROUGHOUT WORK AREA AS INDICATED AND AFTER ALL MAJOR CROSSROADS IF PERMANENT SIGNS ARE NOT IN PLACE.

SPEED LIMIT
X X

R2-1

WORK ZONE BEGINS

R5-18c



W4-2



W20-5



W20-1

KEY

- • • CHANNELIZING DEVICES
- ← LIGHTED ARROW PANEL
- TRAFFIC FLOW
- REFLECTS EXISTING SPEED LIMIT

SIGN = 168 ft±2 - TYPE B PLUS ADDITIONAL R2-1's THROUGHOUT WORK AREA

SHOULDER

SHOULDER



SPEED LIMIT
X X

R2-1

WORK ZONE BEGINS

R5-18c



W4-2



W20-5



W20-1

NOT TO SCALE

		<p>TYPICAL TEMPORARY TRAFFIC CONTROL FOR A ONE-LANE CLOSURE ON A DIVIDED ROADWAY, NO SPEED REDUCTION</p>	
<p>TRAFFIC AND SAFETY MAINTAINING TRAFFIC TYPICAL</p>			
<p>DRAWN BY: CON:AE:djf CHECKED BY: BMM:CRB</p>	<p>OCTOBER 2011 PLAN DATE:</p>	<p>M0730a</p>	<p>SHEET 1 OF 2</p>
<p>FILE: PW RD/TS/Typicals/Signs/MT NON FWY/M0730a.dgn REV. 10/26/2011</p>			

NOTES

- 1B. D = DISTANCE BETWEEN TRAFFIC CONTROL DEVICES
L = MINIMUM LENGTH OF TAPER
B = LENGTH OF LONGITUDINAL BUFFER
SEE M0020a FOR "D," "L," AND "B" VALUES
2. ALL NON-APPLICABLE SIGNING WITHIN THE CIA SHALL BE MODIFIED TO FIT CONDITIONS, COVERED OR REMOVED.
3. DISTANCES BETWEEN SIGNS, THE VALUES FOR WHICH ARE SHOWN IN TABLE D, ARE APPROXIMATE AND MAY NEED ADJUSTING AS DIRECTED BY THE ENGINEER.
- 3A. THE "WORK ZONE BEGINS" (R5-18c) SIGN SHALL BE USED ONLY IN THE INITIAL SIGNING SEQUENCE IN THE WORK ZONE. SUBSEQUENT SEQUENCES IN THE SAME WORK ZONE SHALL OMIT THIS SIGN AND THE QUANTITIES SHALL BE ADJUSTED APPROPRIATELY.
- 4E. THE MAXIMUM RECOMMENDED DISTANCE(S) BETWEEN CHANNELIZING DEVICES SHOULD BE EQUAL IN FEET TO THE POSTED SPEED IN MILES PER HOUR ON TAPER(S) AND TWICE THE POSTED SPEED IN THE PARALLEL AREA(S).
5. FOR OVERNIGHT CLOSURES, TYPE III BARRICADES SHALL BE LIGHTED.
6. WHEN CALLED FOR IN THE FHWA ACCEPTANCE LETTER FOR THE SIGN SYSTEM SELECTED, THE TYPE A WARNING FLASHER, SHOWN ON THE WARNING SIGNS, SHALL BE POSITIONED ON THE SIDE OF THE SIGN NEAREST THE ROADWAY.
7. ALL TEMPORARY SIGNS, TYPE III BARRICADES, THEIR SUPPORT SYSTEMS AND LIGHTING REQUIREMENTS SHALL MEET NCHRP 350 CRASHWORTHLY REQUIREMENTS STIPULATED IN THE CURRENT EDITION OF THE MICHIGAN MANUAL ON UNIFORM TRAFFIC CONTROL DEVICES, THE CURRENT EDITION OF THE STANDARD SPECIFICATIONS FOR CONSTRUCTION, THE STANDARD PLANS AND APPLICABLE SPECIAL PROVISIONS. ONLY DESIGNS AND MATERIALS APPROVED BY MDOT WILL BE ALLOWED.
8. WHEN BUFFER AREAS ARE ESTABLISHED, THERE SHALL BE NO EQUIPMENT OR MATERIALS STORED OR WORK CONDUCTED IN THE BUFFER AREA.
21. ALL EXISTING PAVEMENT MARKINGS WHICH ARE IN CONFLICT WITH EITHER PROPOSED CHANGES IN TRAFFIC PATTERNS OR PROPOSED TEMPORARY TRAFFIC MARKINGS, SHALL BE REMOVED BEFORE ANY CHANGE IS MADE IN THE TRAFFIC PATTERN. EXCEPTION WILL BE MADE FOR DAYTIME-ONLY TRAFFIC PATTERNS THAT ARE ADEQUATELY DELINEATED BY OTHER TRAFFIC CONTROL DEVICES.
26. THE LIGHTED ARROW PANEL SHALL BE LOCATED AT THE BEGINNING OF THE TAPER AS SHOWN. WHEN PHYSICAL LIMITATIONS RESTRICT ITS PLACEMENT AS INDICATED, THEN IT SHALL BE PLACED AS CLOSE TO THE BEGINNING OF THE TAPER AS POSSIBLE.

SIGN SIZES

DIAMOND WARNING - 48" x 48"
R2-1 REGULATORY - 48" x 60"
R5-18c REGULATORY - 48" x 48"

NOT TO SCALE

 Michigan Department of Transportation TRAFFIC AND SAFETY MAINTAINING TRAFFIC TYPICAL		TYPICAL TEMPORARY TRAFFIC CONTROL FOR A ONE-LANE CLOSURE ON A DIVIDED ROADWAY, NO SPEED REDUCTION	
DRAWN BY: CON:AE:djf	OCTOBER 2011	M0730a	SHEET 2 OF 2
CHECKED BY: BMM:CRB	PLAN DATE:		
FILE: PW RD/TS/Typicals/Signs/MT NON FWY/M0730a.dgn REV. 10/26/2011			

SIGN MATERIAL SELECTION TABLE

SIGN SIZE	SIGN MATERIAL TYPE		
	TYPE I	TYPE II	TYPE III
≤ 36" X 36"		X	X
>36" X 36" ≤ 96" TO WIDE		X	
> 96" WIDE TO 144" WIDE	X	X	
> 144" WIDE	X		

TYPE I ALUMINUM EXTRUSION
 TYPE II PLYWOOD
 TYPE III ALUMINUM SHEET

ROUNDING OF CORNERS IS NOT REQUIRED FOR TYPE I OR II SIGNS.
 VERTICAL JOINTS ARE NOT PERMITTED.
 HORIZONTAL JOINTS THROUGH SIGN LEGEND OR SYMBOLS ARE NOT PERMITTED.

POST SIZE REQUIREMENTS TABLE

SIGN AREA (ft ²)	POST TYPE		
	U-CHANNEL STEEL	SQUARE TUBULAR STEEL	WOOD
≤9	1 - 3 lb/ft*	1 - 2" 12 or 14 GA*	N/A
9 ≤ 20	2 - 3 lb/ft	2 - 2" 12 or 14 GA	1 - 4" X 6"*
> 20 ≤ 30	N/A	N/A	2 - 4" X 6"
> 30 ≤ 60	N/A	N/A	2 - 6" X 8"
> 60 ≤ 84	N/A	N/A	3 - 6" X 8"

*SIGNS 4 FEET AND GREATER IN WIDTH REQUIRE 2 POSTS.
 SIGNS GREATER THAN 8 FEET IN WIDTH REQUIRE 2 OR 3 WOOD
 POSTS DEPENDING ON AREA OF SIGN.
 A MAXIMUM OF 2 POSTS WITHIN A 7' PATH IS PERMITTED.

NOT TO SCALE

File:PW/Doc/RD/T&S/Typ/Dev/Sign MainTraf D/WZD-100-A Rev. 8/21/06 ECH

 Michigan Department of Transportation PREPARED BY TRAFFIC AND SAFETY SUPPORT AREA	_____ ENGINEER OF DELIVERY	MICHIGAN DEPARTMENT OF TRANSPORTATION BUREAU OF HIGHWAYS DELIVERY STANDARD PLAN FOR GROUND DRIVEN SIGN SUPPORTS FOR TEMP SIGNS	
	_____ ENGINEER OF DEVELOPMENT PENDING _____ FHWA APPROVAL DATE	8/2006 PLAN DATE	WZD-100-A

NOTE: THE ORIGINAL SIGNED COPY IS KEPT ON FILE AT THE MICHIGAN DEPARTMENT OF TRANSPORTATION.

2 POST SIGN SUPPORT SPACING

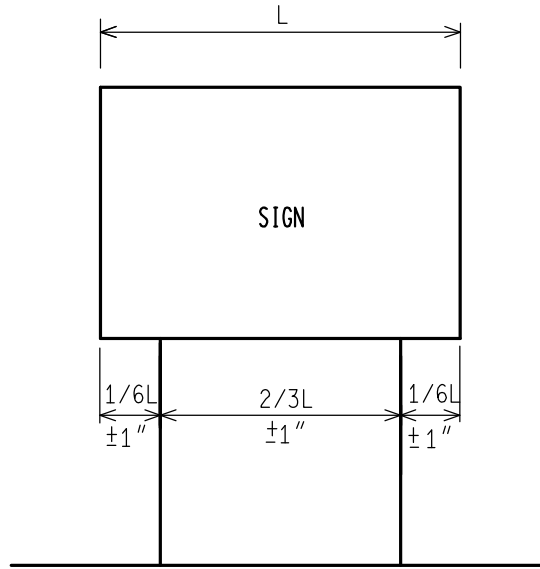

3 POST SIGN SUPPORT SPACING

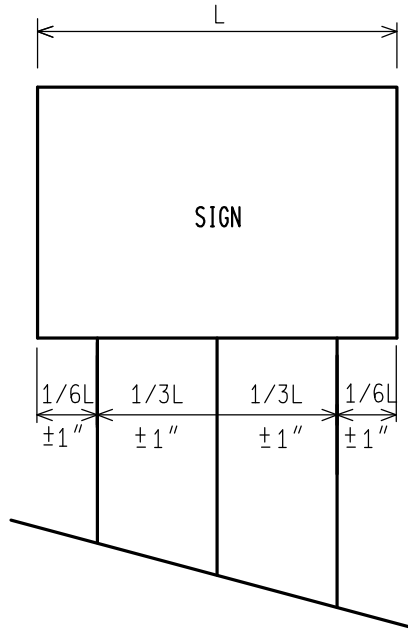

* FOR ALL 11' AND 12' LONG SIGNS ON 3 WOOD SUPPORTS, SPREAD POSTS SO AS TO HAVE A 8' MIN. TO 9' MAX. DISTANCE BETWEEN OUTSIDE POSTS.

NOT TO SCALE

MICHIGAN DEPARTMENT OF TRANSPORTATION BUREAU OF HIGHWAYS DELIVERY STANDARD PLAN	PENDING FHWA APPROVAL DATE	8/2006 PLAN DATE	<h3 style="margin: 0;">WZD-100-A</h3>	SHEET 2 of 11
File:PW/Doc/RD/T&S/Typ/Dev/Sign MainTraf D/WZD-100-A Rev. 8/21/06 ECH				

NOTE: THE ORIGINAL SIGNED COPY IS KEPT ON FILE AT THE MICHIGAN DEPARTMENT OF TRANSPORTATION.

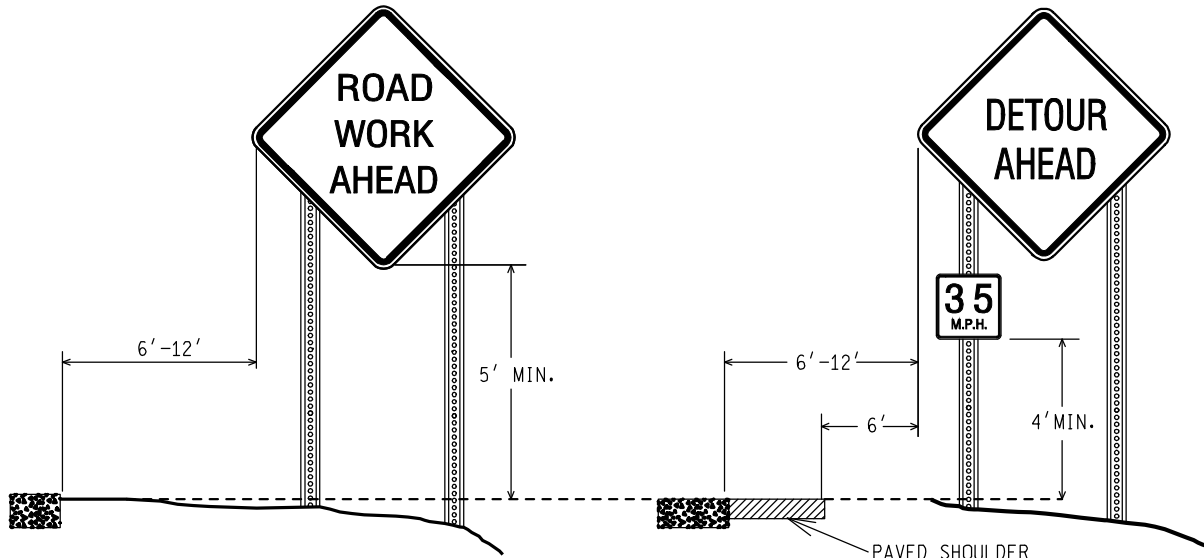

RURAL

RURAL WITH ADVISORY SPEED PLATE

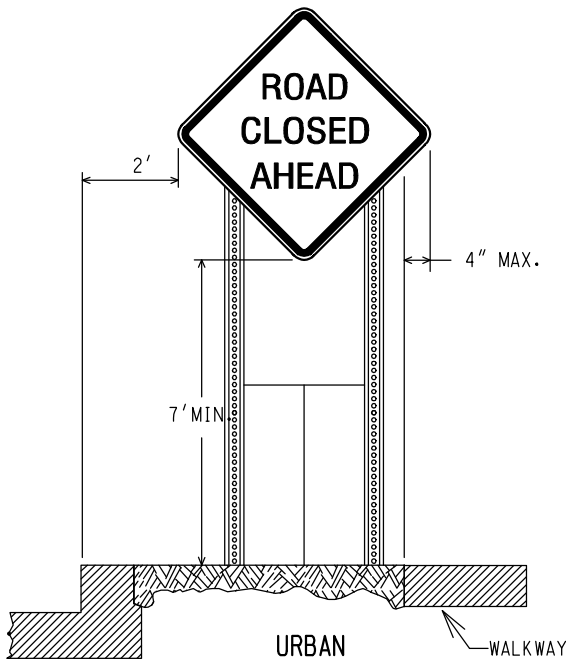

URBAN

WALKWAY

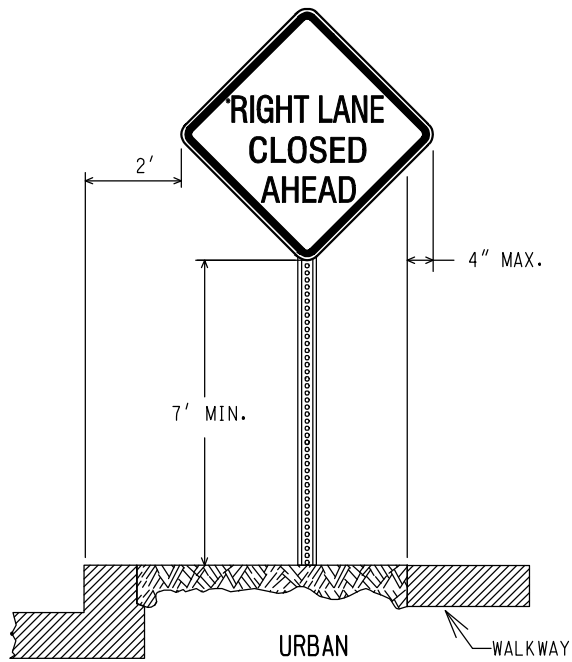

URBAN

WALKWAY

(CURBED AREAS OR WHERE WALKWAYS ARE PRESENT)

(CURBED AREAS OR WHERE WALKWAYS ARE PRESENT)

BOTTOM HEIGHT AND OFFSET

NOT TO SCALE

MICHIGAN DEPARTMENT OF TRANSPORTATION
BUREAU OF HIGHWAYS DELIVERY STANDARD PLAN

PENDING
FHWA APPROVAL DATE

8/2006
PLAN DATE

WZD-100-A

SHEET
3 of 11

File:PW/Doc/RD/T&S/Typ/Dev/Sign MainTraf D/WZD-100-A Rev. 8/21/06 ECH

NOTE: THE ORIGINAL SIGNED COPY IS KEPT ON FILE AT THE MICHIGAN DEPARTMENT OF TRANSPORTATION.

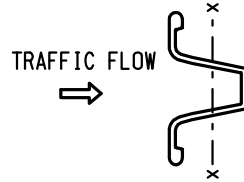
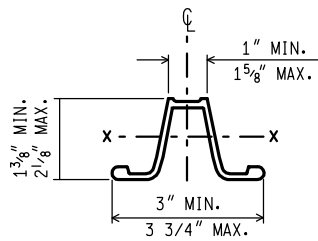
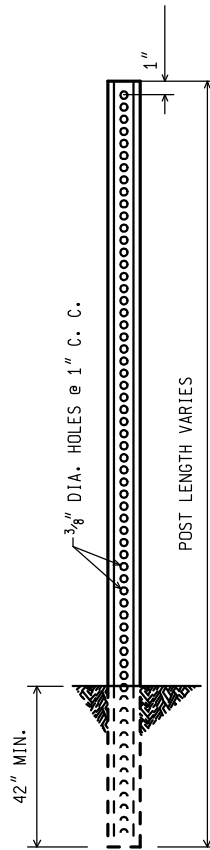

WEIGHT = 3 lbs/ft
 SECT. MOD. X.-X. = 0.31 CUBIC INCHES MIN.

3 lb. U - CHANNEL STEEL POST (NO SPLICE)

MOUNT SIGN ON OPEN FACE OF
 U - CHANNEL STEEL POST

NOT TO SCALE

MICHIGAN DEPARTMENT OF TRANSPORTATION
 BUREAU OF HIGHWAYS DELIVERY STANDARD PLAN

PENDING

 FHWA APPROVAL DATE

8/2006
 PLAN DATE

WZD-100-A

SHEET
 4 of 11

File:PW/Doc/RD/T&S/Typ/Dev/Sign MainTraf D/WZD-100-A Rev. 8/21/06 ECH

NOTE: THE ORIGINAL SIGNED COPY IS KEPT ON FILE AT THE MICHIGAN DEPARTMENT OF TRANSPORTATION.

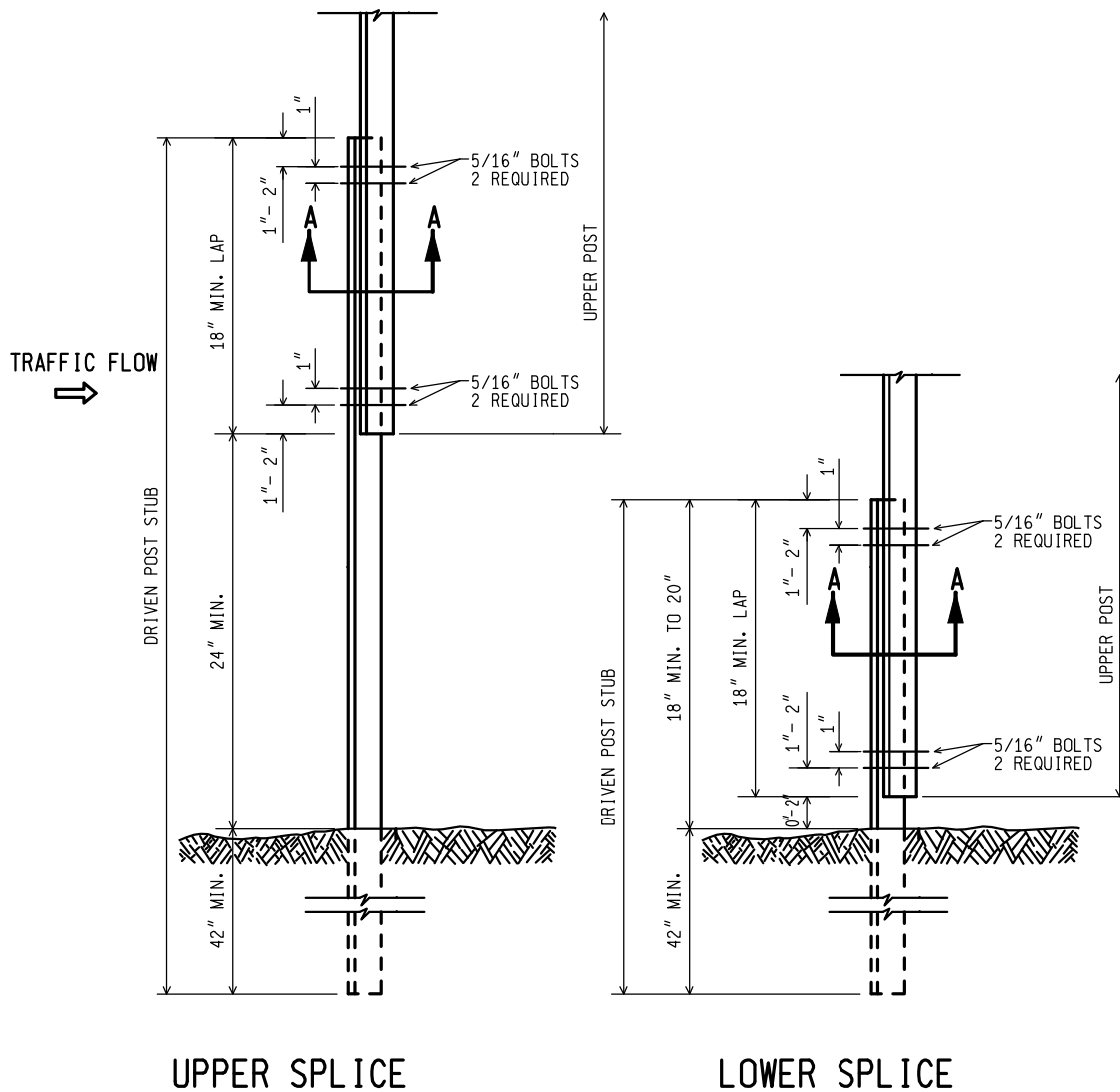

**3 lb. U - CHANNEL STEEL POST
(WITH SPLICE)**

MOUNT SIGN ON OPEN FACE OF
UPPER U - CHANNEL STEEL POST

NOT TO SCALE

MICHIGAN DEPARTMENT OF TRANSPORTATION
BUREAU OF HIGHWAYS DELIVERY STANDARD PLAN

PENDING
FHWA APPROVAL DATE

8/2006
PLAN DATE

WZD-100-A

SHEET
5 of 11

File:PW/Doc/RD/T&S/Typ/Dev/Sign MainTraf D/WZD-100-A Rev. 8/21/06 ECH

NOTE: THE ORIGINAL SIGNED COPY IS KEPT ON FILE AT THE MICHIGAN DEPARTMENT OF TRANSPORTATION.

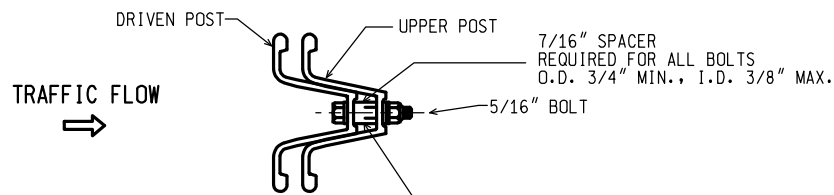

SECTION A-A

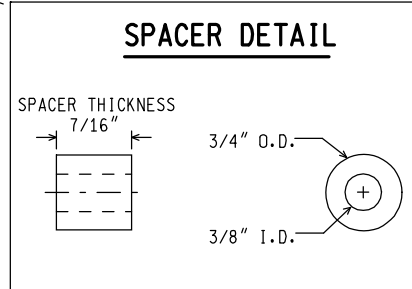

NOTES:

1. THE SPACER THICKNESS SHALL BE 1/16" LESS THAN THE GAP BETWEEN THE POST WHEN POSITIONED IN THE UNBOLTED CONFIGURATION.
2. THE EXTERIOR BOLT (CLOSEST TO LAP), SPACER, WASHER, AND NUT SHALL BE INSTALLED IN A PREPUNCHED HOLE 1" TO 2" FROM THE END OF THE LAP.
3. THE INTERIOR BOLT (FARTHEST FROM LAP), SPACER, WASHER, AND NUT SHALL BE INSTALLED IN THE NEXT PREPUNCHED HOLE.
4. THE DRIVEN POST SHALL ALWAYS BE MOUNTED IN FRONT OF THE UPPER POST WITH RESPECT TO THE ADJACENT ONCOMING TRAFFIC, REGARDLESS OF THE DIRECTION THE SIGN IS FACING.
5. THE SPLICE LAP SHALL BE FASTENED BY FOUR-5/16" DIA. GALVANIZED A449 BOLTS (SAE J429 GRADE 5) OR GALVANIZED A325 BOLTS.

3 1b. U - CHANNEL STEEL POST
(WITH SPLICE)

NOT TO SCALE

MICHIGAN DEPARTMENT OF TRANSPORTATION BUREAU OF HIGHWAYS DELIVERY STANDARD PLAN	PENDING	8/2006	WZD-100-A	SHEET 6 of 11
	FHWA APPROVAL DATE			
File:PW/Doc/RD/T&S/Typ/Dev/Sign MainTraf D/WZD-100-A Rev. 8/21/06 ECH				

NOTE: THE ORIGINAL SIGNED COPY IS KEPT ON FILE AT THE MICHIGAN DEPARTMENT OF TRANSPORTATION.

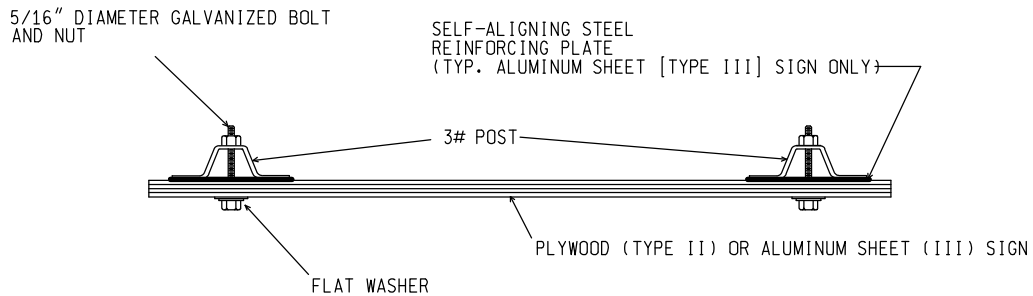

SIGN TO 3 lb. POST CONNECTION

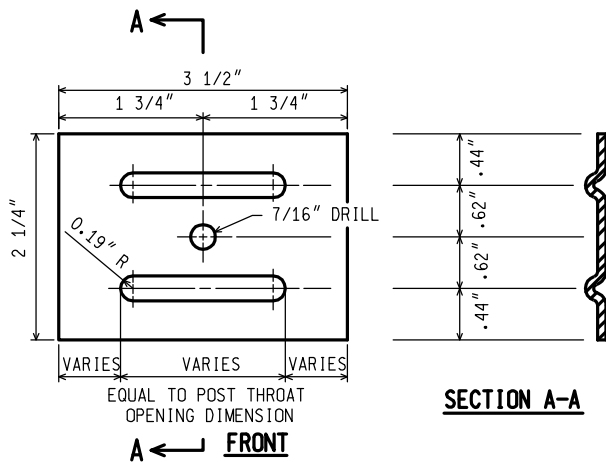

NOTES: (FOR STEEL SIGN REINF' PLATE)

1. MATERIAL: 12 GAUGE CARBON STEEL.
2. TOLERANCE ON ALL DIMENSIONS $\pm 0.0625"$
3. FINISH-AFTER STAMPING AND PUNCHING, GALVANIZE ACCORDING TO CURRENT SPECIFICATIONS FOR ZINC (HOT GALVANIZE) COATINGS ON PRODUCTS FABRICATED FROM PLATES OR STRIPS

STEEL SIGN REINFORCING PLATE
REQUIRED FOR TYPE III SIGNS ONLY

3 lb. U - CHANNEL STEEL POST SIGN CONNECTION

NOT TO SCALE

MICHIGAN DEPARTMENT OF TRANSPORTATION
BUREAU OF HIGHWAYS DELIVERY STANDARD PLAN

PENDING
FHWA APPROVAL DATE

8/2006
PLAN DATE

WZD-100-A

SHEET
7 of 11

File:PW/Doc/RD/T&S/Typ/Dev/Sign MainTraf D/WZD-100-A Rev. 8/21/06 ECH
NOTE: THE ORIGINAL SIGNED COPY IS KEPT ON FILE AT THE MICHIGAN DEPARTMENT OF TRANSPORTATION.

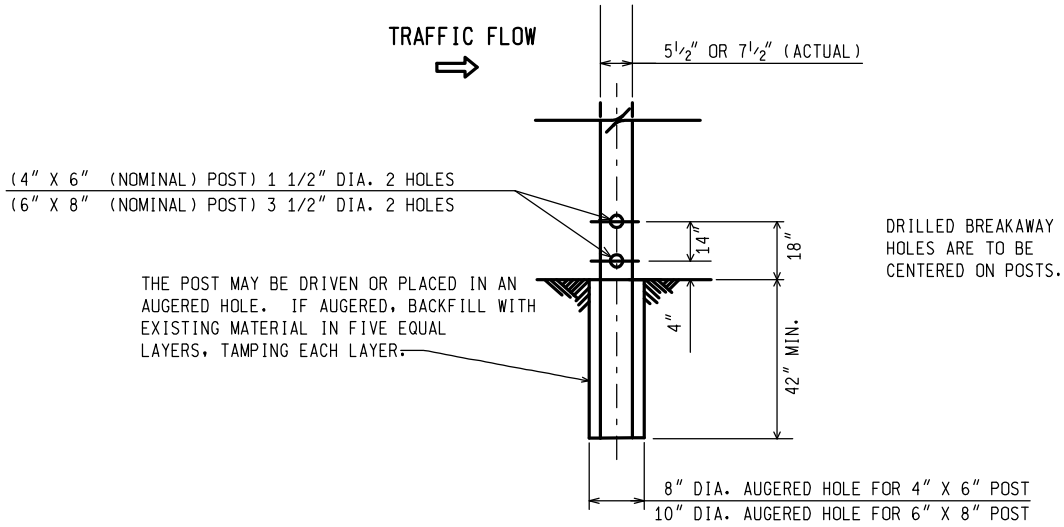

**WOOD POST BREAKAWAY HOLES/
 DIRECT EMBEDMENT DETAILS**

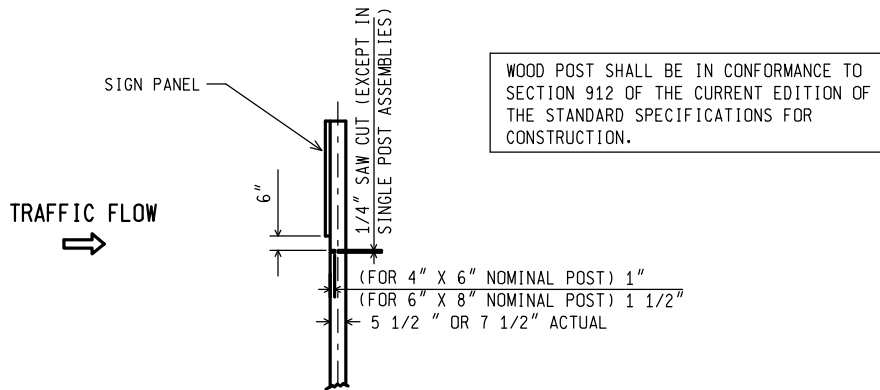

**SAW CUT DETAIL
 (MULTIPLE POST INSTALLATIONS)**

WOOD POST DETAILS

NOT TO SCALE

MICHIGAN DEPARTMENT OF TRANSPORTATION
 BUREAU OF HIGHWAYS DELIVERY STANDARD PLAN

PENDING
 FHWA APPROVAL DATE

8/2006
 PLAN DATE

WZD-100-A

SHEET
 8 of 11

File:PW/Doc/RD/T&S/Typ/Dev/Sign MainTraf D/WZD-100-A Rev. 8/21/06 ECH

NOTE: THE ORIGINAL SIGNED COPY IS KEPT ON FILE AT THE MICHIGAN DEPARTMENT OF TRANSPORTATION.

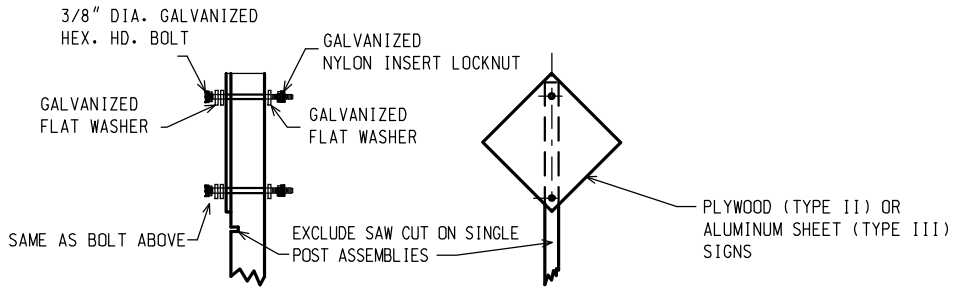

TYPE II AND TYPE III SIGNS

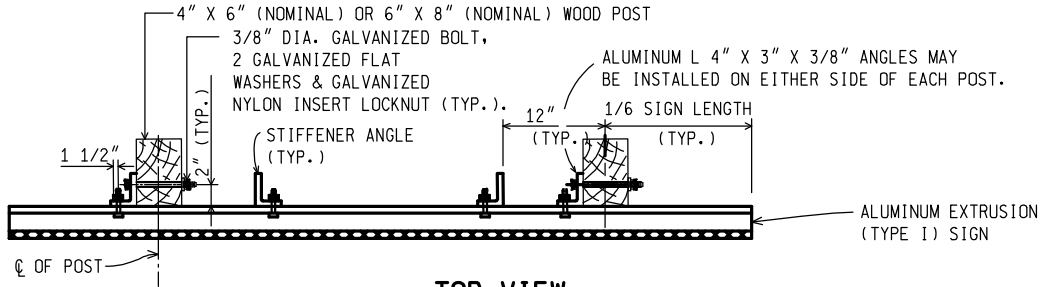

**TOP VIEW
TYPE I SIGN**

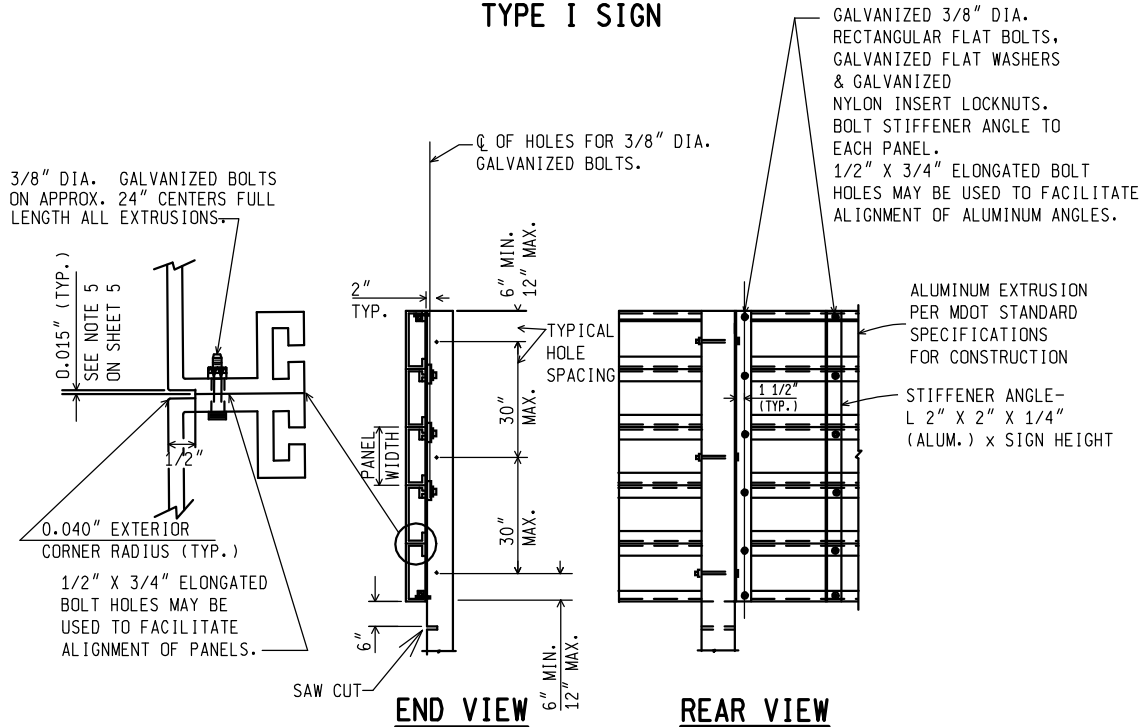

TYPE I SIGN - ERECTION DETAILS

WOOD POST CONNECTIONS

NOT TO SCALE

MICHIGAN DEPARTMENT OF TRANSPORTATION
BUREAU OF HIGHWAYS DELIVERY STANDARD PLAN

PENDING
FHWA APPROVAL DATE

8/2006

WZD-100-A

SHEET
9 of 11

File:PW/Doc/RD/T&S/Typ/Dev/Sign MainTraf D/WZD-100-A Rev. 8/21/06 ECH

PLAN DATE

NOTE: THE ORIGINAL SIGNED COPY IS KEPT ON FILE AT THE MICHIGAN DEPARTMENT OF TRANSPORTATION.

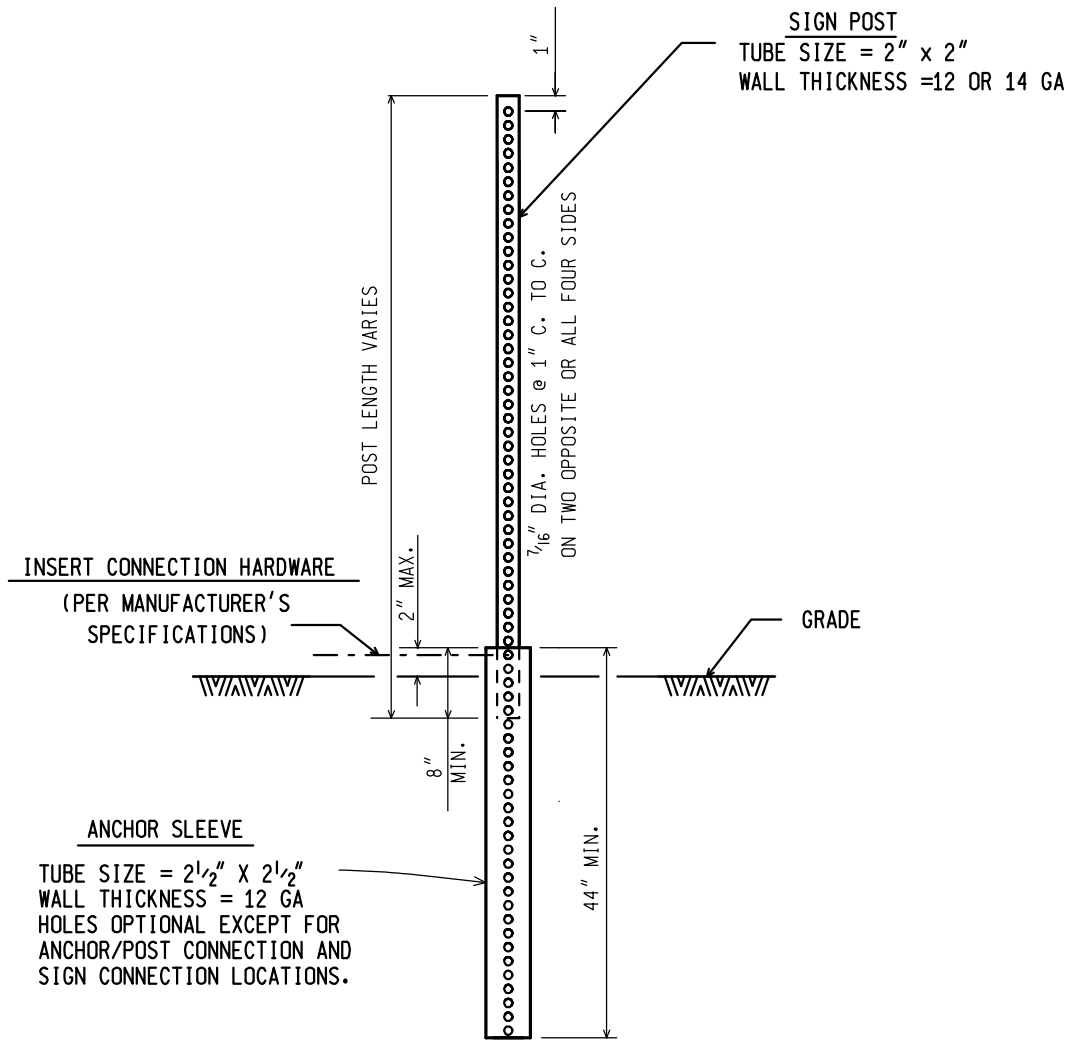

SQUARE TUBULAR STEEL POST

NOT TO SCALE

MICHIGAN DEPARTMENT OF TRANSPORTATION BUREAU OF HIGHWAYS DELIVERY STANDARD PLAN	PENDING	8/2006	WZD-100-A	SHEET 10 of 11
	FHWA APPROVAL DATE			

NOTE: THE ORIGINAL SIGNED COPY IS KEPT ON FILE AT THE MICHIGAN DEPARTMENT OF TRANSPORTATION.

GENERAL NOTES:

1. A MAXIMUM OF TWO POSTS WITHIN A 7 FOOT PATH IS PERMITTED.
2. ALL SIGN POSTS SHALL COMPLY WITH NCHRP 350.
3. ALL POSTS SHALL BE EMBEDDED A MINIMUM OF 42".
4. BRACING OF POST IS NOT PERMITTED.
5. SIGN SHALL BE LEVEL, AND UPRIGHT FOR THE DURATION OF INSTALLATION.
6. ERECT POSTS SO THE SIGN FACE AND SUPPORTS DO NOT VARY FROM PLUMB BY MORE THAN 3/16" IN 3'. PROVIDE A CENTER-TO-CENTER DISTANCE BETWEEN POSTS WITHIN 2 PERCENT OF PLAN DISTANCE.
7. NO MORE THAN ONE SPLICE PER POST, AS SHOWN, WILL BE PERMITTED.
8. POST TYPES SHALL NOT BE MIXED WITHIN A SIGN SUPPORT INSTALLATION.
9. NO VERTICAL JOINTS ARE PERMITTED IN SIGN. NO HORIZONTAL JOINTS THROUGH SIGN LEGEND OR SYMBOLS ARE PERMITTED IN SIGN
10. REMOVE SIGN POSTS AND/OR POST STUBS IN THEIR ENTIRETY WHEN NO LONGER REQUIRED.
11. ALL LABOR, MATERIALS, AND EQUIPMENT, INCLUDING TEMPORARY SUPPORTS REQUIRED TO INSTALL, MAINTAIN, RELOCATE, COVER, AND/OR REMOVE THE TEMPORARY SIGN, INCLUDING SUPPORTS, ARE CONSIDERED TO BE INCLUDED IN THE COST OF THE TEMPORARY SIGN.
12. SAW CUTS IN WOOD POSTS ARE TO BE PARALLEL TO THE BOTTOM OF THE SIGN.
13. POSTS SHALL NOT EXTEND MORE THAN 4" ABOVE TOP OF SIGN.

NOT TO SCALE

MICHIGAN DEPARTMENT OF TRANSPORTATION BUREAU OF HIGHWAYS DELIVERY STANDARD PLAN	PENDING FHWA APPROVAL DATE	8/2006 PLAN DATE	WZD-100-A	SHEET 11 of 11
File:PW/Doc/RD/T&S/Typ/Dev/Sign MainTraf D/WZD-100-A Rev. 8/21/06 ECH				

NOTE: THE ORIGINAL SIGNED COPY IS KEPT ON FILE AT THE MICHIGAN DEPARTMENT OF TRANSPORTATION.

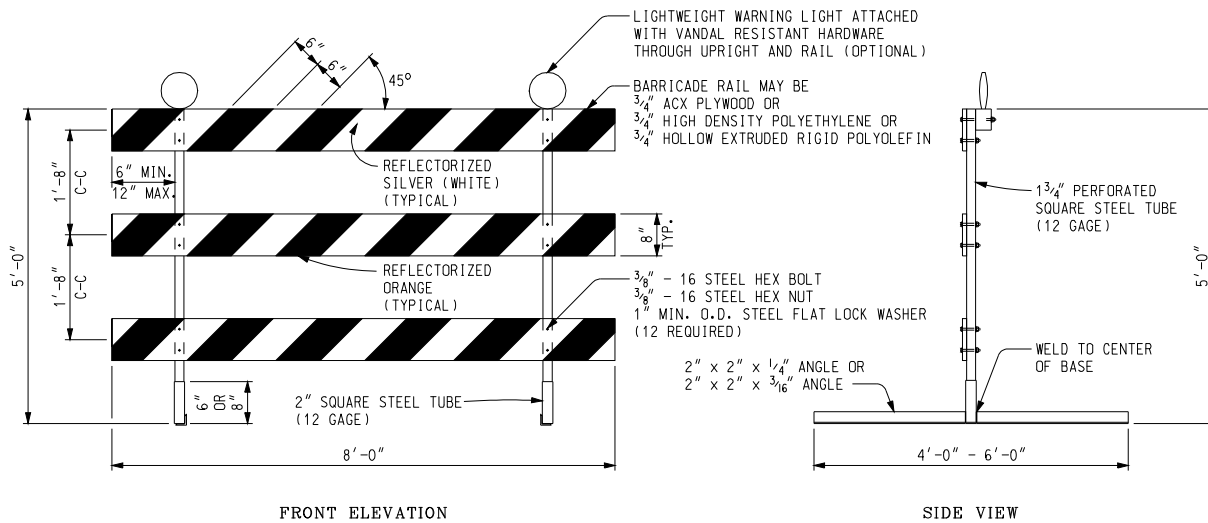

FRONT ELEVATION

SIDE VIEW

PERFORATED SQUARE STEEL TUBE OPTION

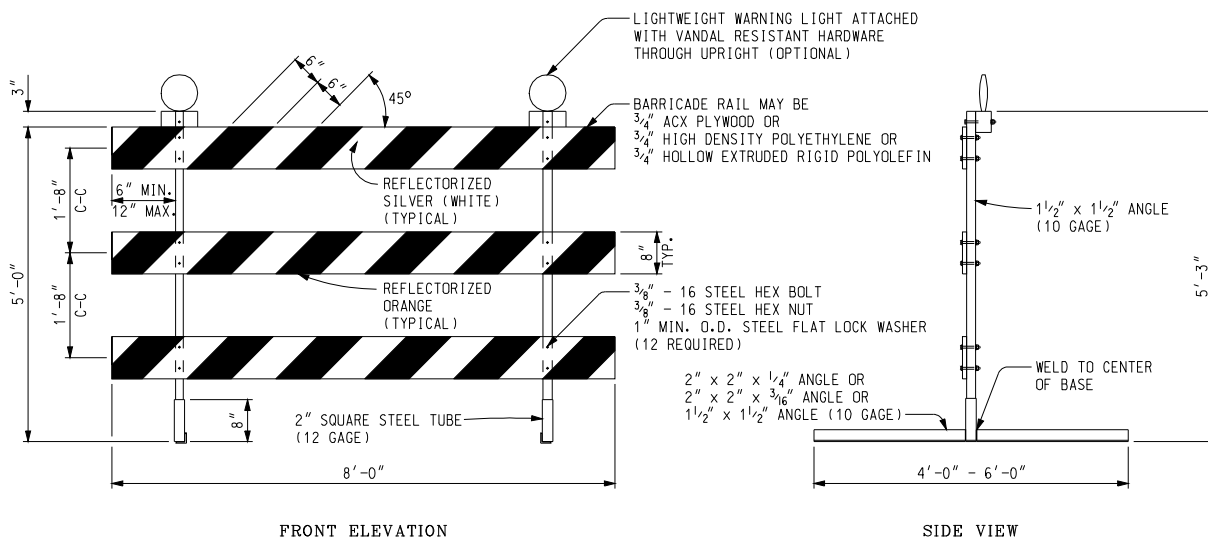

FRONT ELEVATION

SIDE VIEW

ANGLE IRON OPTION

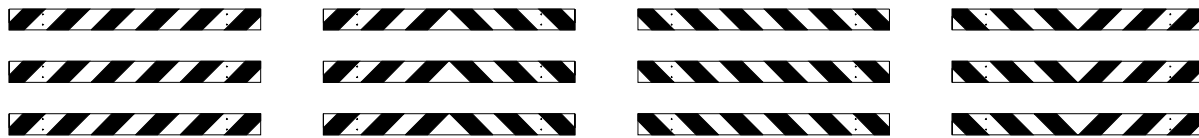

LEFT DIRECTIONAL

BI-DIRECTIONAL

RIGHT DIRECTIONAL

CLOSURES

BARRICADE RAIL SHEETING OPTIONS
TYPE III BARRICADES

Other Type III Barricades meeting current NCHRP crash worthy criteria can be found on the FHWA Safety website at

http://safety.fhwa.dot.gov/roadway_dept/road_hardware/wzd.htm

NOT TO SCALE

File: T&S/Typ/Signs/WorkZones/wzd 125 d

Rev. 09/22/09 PJ



PREPARED BY
TRAFFIC AND SAFETY

DRAWN BY: ECH

CHECKED BY: MWB

ENGINEER OF DELIVERY

ENGINEER OF DEVELOPMENT

(SPECIAL DETAIL)

FHWA APPROVAL DATE

MICHIGAN DEPARTMENT OF TRANSPORTATION
BUREAU OF HIGHWAYS DELIVERY STANDARD PLAN FOR

Temporary
Traffic Control Devices

9/22/09
PLAN DATE

WZD-125-E

SHEET
1 of 3

NOTE: THE ORIGINAL SIGNED COPY IS KEPT ON FILE AT THE MICHIGAN DEPARTMENT OF TRANSPORTATION.

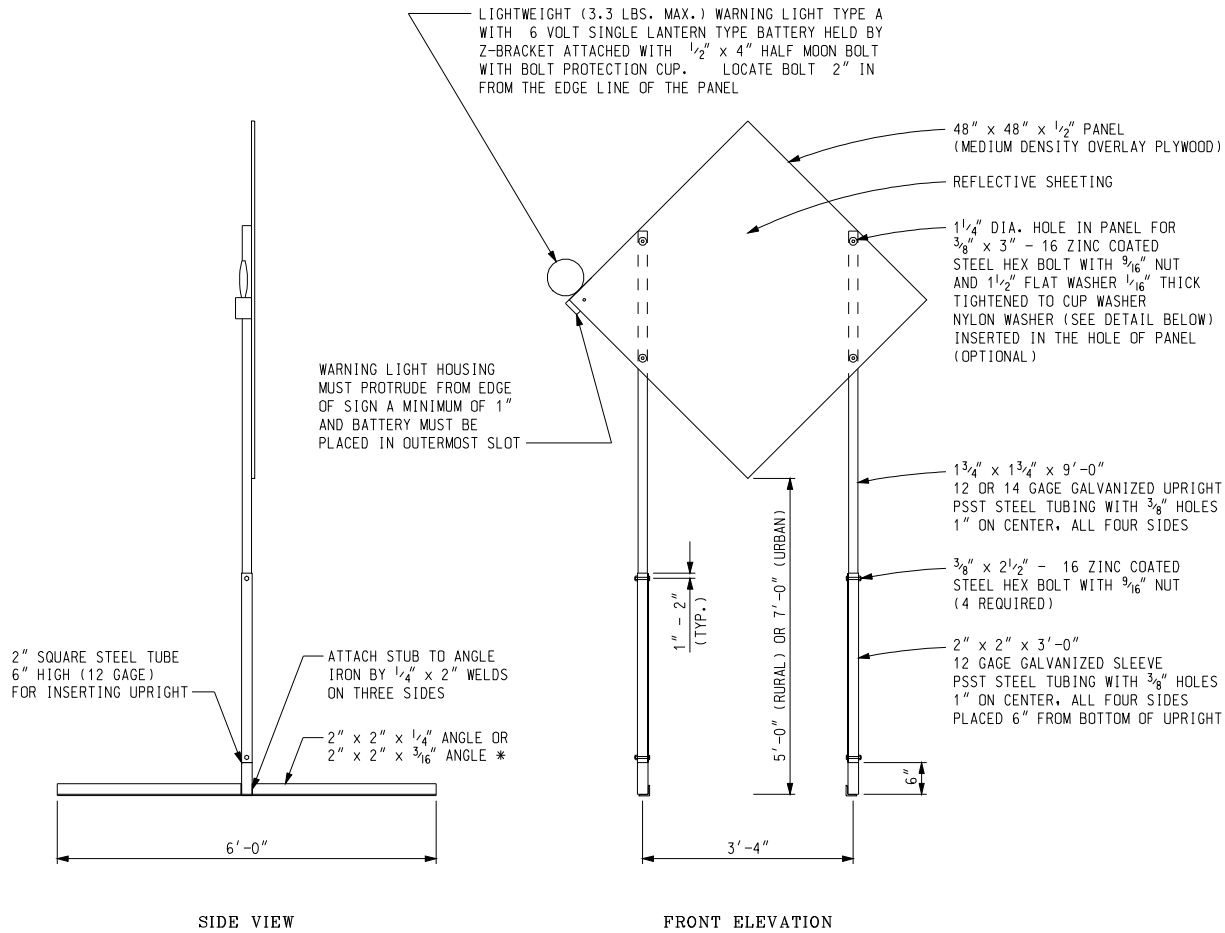

TEMPORARY SIGN SUPPORT

(WARNING LIGHT PLACED ON SIDE CLOSEST TO TRAFFIC)

- * SIGN STAND IS BALLASTED WITH FOUR OR MORE 35 LB SANDBAGS. A MINIMUM OF ONE ON EACH END.
- UPRIGHTS SHALL NOT EXTEND ABOVE THE SIGN PANEL.

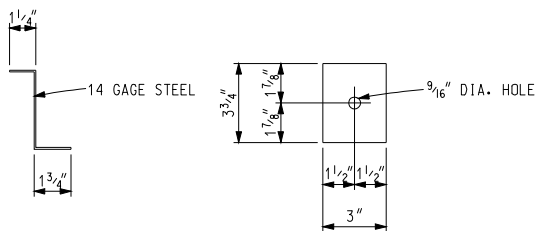

Z-BRACKET DETAIL

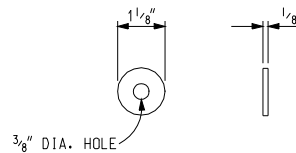

OPTIONAL NYLON WASHER

Other temporary sign supports meeting current NCHRP crash worthy criteria can be found on the FHWA Safety website at http://safety.fhwa.dot.gov/roadway_dept/road_hardware/wzd.htm

NOT TO SCALE

MICHIGAN DEPARTMENT OF TRANSPORTATION BUREAU OF HIGHWAYS DELIVERY STANDARD PLAN	(SPECIAL DETAIL) FHWA APPROVAL DATE	9/22/09	WZD-125-E	SHEET 2 of 3
File: T&S/Typ/Signs/WorkZones/wzd 125 d	Rev. 09/22/09 PJ	PLAN DATE		

NOTE: THE ORIGINAL SIGNED COPY IS KEPT ON FILE AT THE MICHIGAN DEPARTMENT OF TRANSPORTATION.

- PLASTIC DRUM
- ▲▲▲ PROPOSED TYPE III BARRICADE
- △△△ EXISTING TYPE III BARRICADE

SYMBOLS TO BE USED ON PLANS

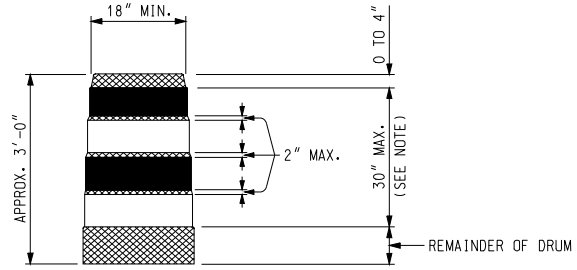

- REFLECTORIZED ORANGE
- REFLECTORIZED WHITE
- ▨ NON REFLECTORIZED ORANGE

NOTE:
 DRUMS SHALL HAVE AT LEAST 4 HORIZONTAL REFLECTORIZED STRIPES (2 ORANGE AND 2 WHITE) OF 6" UNIFORM WIDTH, ALTERNATING IN COLOR WITH THE TOPMOST REFLECTORIZED STRIPE BEING ORANGE. NON REFLECTORIZED SPACES BETWEEN THE HORIZONTAL REFLECTORIZED ORANGE AND WHITE STRIPES SHALL BE ORANGE IN COLOR AND EQUAL IN WIDTH.

PLASTIC DRUM

NOTES:

2" PERFORATED SQUARE STEEL TUBES MAY BE USED TO FABRICATE THE HORIZONTAL BASE OF THE TYPE III BARRICADE.

WARNING LIGHTS SHALL BE PLACED ACCORDING TO THE CURRENT STANDARD SPECIFICATIONS FOR CONSTRUCTION AND ALL OTHER PROVISIONS IN THE CONTRACT WHEN THEY ARE USED ON TYPE III BARRICADES.

SEE ROAD STANDARD PLANS R-113-SERIES FOR TEMPORARY CROSSOVERS FOR DIVIDED ROADWAY, AND R-126-SERIES FOR TYPICAL LOCATION AND SPACING OF PLASTIC DRUMS FOR PLACEMENT OF TEMPORARY CONCRETE BARRIER.

SIGNS, BARRICADES, AND PLASTIC DRUMS SHALL BE FACED WITH PRESSURE-SENSITIVE REFLECTIVE SHEETING ACCORDING TO THE CURRENT STANDARD SPECIFICATIONS FOR CONSTRUCTION.

SANDBAGS SHALL BE USED WHEN SUPPLEMENTAL WEIGHTS ARE REQUIRED TO ACHIEVE STABILITY OF THE BARRICADE. THE SANDBAGS SHALL BE PLACED SO THEY WILL NOT COVER OR OBSTRUCT ANY REFLECTIVE PORTION OF THE TRAFFIC CONTROL DEVICE.

NOT TO SCALE

MICHIGAN DEPARTMENT OF TRANSPORTATION BUREAU OF HIGHWAYS DELIVERY STANDARD PLAN	(SPECIAL DETAIL) FHWA APPROVAL DATE	9/22/09	WZD-125-E	SHEET 3 of 3
File: T&S/Typ/Signs/WorkZones/wzd 125 d	Rev. 09/22/09 PJ	PLAN DATE		

NOTE: THE ORIGINAL SIGNED COPY IS KEPT ON FILE AT THE MICHIGAN DEPARTMENT OF TRANSPORTATION.

Street Crack Treatment - 2017 (Phase 2)

PHASE 2 - Work to start on/after July 1, 2017 and be complete by/before June 30, 2018

Street Name	Limits		Beginning Milepoint	Ending Milepoint	Length (miles)	
	Beginning	Ending			Centerline	Lane
MAJOR STREETS						
Barton Drive	Pontiac Trl	Plymouth Rd	0.624	1.065	0.441	0.882
Dexter Avenue	M-14	W Huron St	6.547	8.283	1.736	3.472
E Huron River Drive	S Huron Pkwy	City Limit	0.000	0.452	0.452	0.904
Geddes Ave	N University Ave	Church St	0.000	0.106	0.106	0.212
Fletcher Street	E Washington St	E Huron St	0.000	0.184	0.184	0.431
Fuller Rd	Fuller Ct	Glazier Way	0.000	0.260	0.260	0.780
Fuller Road (EB)	Maiden Ln/E Medical Center Dr	Huron River Bridge	0.000	0.388	0.388	0.776
Fuller Road (WB)	Maiden Ln/E Medical Center Dr	Huron River Bridge	0.000	0.390	0.390	0.780
Fuller Road	Huron River Bridge	Bonisteel Blvd	0.390	0.694	0.304	0.608
Fuller Road	Bonisteel Blvd	Glazier Way	0.000	0.365	0.365	1.825
Fuller Street	N State St/Depot St	Glen Ave/Fuller Rd	0.376	0.678	0.302	0.906
Hill Street	Oxford Rd	Onondaga St	1.233	1.459	0.226	0.452
Miller Avenue	N Maple Rd	Linda Vista St	3.456	4.409	0.953	1.906
Miller Avenue	Chapin St	N 1st St	5.076	5.188	0.112	0.224
Miller Avenue	N 1st St	N Main St	0.000	0.126	0.126	0.312
Packard Street	Stadium Blvd	Anderson Ave/Harpst St	1.479	1.786	0.301	0.903
Packard Street	Kimberly St	E Eisenhower Pkwy	2.748	2.874	0.126	0.504
Packard Road	End of Boulevard	Platt Rd	3.083	3.610	0.527	2.635
Platt Road	City Limit	I-94 Bridge	10.214	10.261	0.047	0.141
Platt Road	I-94 Bridge	Packard St	10.326	10.509	0.851	2.553
Pontiac Trail	Swift St	John A Woods Dr	0.000	0.102	0.531	1.062
S 1st Street	W Liberty St	W Liberty St	0.465	0.465	0.176	0.352
S 5th Avenue	E Jefferson St	E Ann St	0.312	0.729	0.177	0.354
S 5th Avenue	Beakes St	Depot St	0.987	1.144	0.157	0.314
S Ashley Street	W William St	W Washington St	0.472	0.534	0.175	0.350
Swift St	Pontiac Trl	Broadway St	0.071	0.109	0.038	0.076
E Eisenhower Parkway (WB)	Stone School Road	Parckard Rd	0.000	0.262	0.262	0.524
E Eisenhower Parkway (EB)	Ann Arbor Saline Rd	S Main St/Briarwood Cir	2.226	2.508	0.282	0.564
W Eisenhower Parkway (EB)	Ann Arbor Saline Rd	S Main St/Briarwood Cir	0.000	0.693	0.693	1.386
W Eisenhower Parkway (WB)	Ann Arbor Saline Rd	S Main St/Briarwood Cir	0.000	0.682	0.682	1.364
W Liberty Street	S Division	S State St	7.989	8.155	0.166	0.332

Street Crack Treatment - 2017 (Phase 2)

Street Name	Limits		Beginning Milepoint	Ending Milepoint	Length (miles)	
	Beginning	Ending			Centerline	Lane
W Stadium Boulevard	Henry St/S Industrial Hwy/E Park Pl	Packard St	2.790	3.186	0.396	1.980
W Washington Street	S State St	Fletcher St	1.273	1.462	0.189	0.378
MINOR (LOCAL) STREETS						
3rd St	W William St	W Liberty St	0.544	0.610	0.066	0.132
Baldwin Ave	Wells St	Baldwin Pl	0.180	0.252	0.072	0.144
Baldwin Ave	E Stadium Blvd	Shadford Rd	0.128	0.192	0.064	0.128
Baldwin Pl	Baldwin Ave	Dead End or Start	0.000	0.044	0.044	0.088
Beechwood Dr	Huron View Blvd	E M 14	0.165	0.232	0.067	0.134
Beechwood Dr	W M 14	City/Twp Line	0.250	0.336	0.086	0.172
Belmont Rd	Toumy Rd	Melrose Ave	0.000	0.037	0.037	0.074
Birch Hollow Dr	Pebble Creek Dr	Stone School Rd	0.066	0.264	0.198	0.396
Birk Ave	Snyder Ave	Potter Ave	0.034	0.140	0.106	0.212
Blaney Dr	Steeplechase Dr	Wiltshire Dr	0.000	0.147	0.147	0.294
Burwood Ave	W Liberty St	Thaler Ave	0.000	0.078	0.078	0.156
Cambridge Rd	Olivia Ave	Lincoln Ave	0.093	0.132	0.039	0.078
Cambridge Rd	Olivia Ave	Lincoln Ave	0.132	0.189	0.057	0.114
Camelot Rd	Gladstone Ave	Kimberly Rd	0.095	0.164	0.069	0.138
Catalina Dr	Avondale Ave	Palomar Dr	0.000	0.171	0.171	0.342
Center Dr	Bernice St	W Sequoia Pkwy	0.303	0.397	0.094	0.188
Churchill Dr	Amesbury Dr	Wiltshire Dr	0.173	0.252	0.079	0.158
Creal Cres	Hatcher Cres	Dead End or Start	0.381	0.426	0.045	0.090
Dartmoor Rd	Ivywood Dr	Dover Ct	0.000	0.053	0.053	0.106
Dartmoor Rd	Dover Ct	Hampton Ct	0.053	0.095	0.042	0.084
Dartmoor Rd	Ivywood Dr	Peppermill Way	0.122	0.211	0.089	0.178
Delaware Dr	S 7th St	Mershon Dr	0.320	0.540	0.220	0.440
Dorset Rd	Onondaga St	Berkshire Rd	0.000	0.089	0.089	0.178
Eagle Ct	Hickory Point Dr	Dead End or Start	0.000	0.057	0.057	0.114
Elm St	Washtenaw Ave	S University Ave	0.000	0.022	0.022	0.044
Ember Way	Gladstone Ave	Candlewick Dr	0.000	0.229	0.229	0.458
Ember Way	Candlewick Dr	Emerald Ave	0.000	0.119	0.119	0.238
Emily Ct	Meadowside Dr/Woodcreek Dr	Dead End or Start	0.000	0.066	0.066	0.132
Fair Oaks Pkwy	Attribute Change	Oak St	0.120	0.153	0.033	0.066
Fair St	Glendale Dr	Glendale Cir	0.000	0.007	0.007	0.014
Forest Ct	S Forest Ave	Washtenaw Ave	0.000	0.142	0.142	0.284

Street Crack Treatment - 2017 (Phase 2)

Street Name	Limits		Beginning Milepoint	Ending Milepoint	Length (miles)	
	Beginning	Ending			Centerline	Lane
Glastonbury Rd	Runnymede Blvd	Dead End or Start	0.157	0.231	0.074	0.148
Glendale Dr	Fair St	Charlton St	0.000	0.053	0.053	0.106
Gralake Ave	Andrea Ct	Lakeview Dr	0.235	0.269	0.034	0.068
Hall Ave	Drappatz Hts	Winchell Dr	0.120	0.209	0.089	0.178
Harpst St	Anderson Ave/Packard St	Page Ave	0.000	0.119	0.119	0.238
Hasper Dr	S Circle Dr	N Circle Dr	0.000	0.170	0.170	0.340
Hazelwood Ave	Dolph Dr	Ray Ct	0.000	0.042	0.042	0.084
Hazelwood Ave	Ray Ct	Sunnywood Dr	0.042	0.126	0.084	0.168
Heather Way St	Arlington Blvd/Devonshire Rd	Aberdeen Dr	0.235	0.405	0.170	0.340
Heather Way St	Aberdeen Dr	Glendaloch Rd	0.405	0.473	0.068	0.136
Heatheridge St	E Heatheridge St	E Haven St/Haven St	0.044	0.081	0.037	0.074
Henry St	Montclair Pl	Packard St	0.386	0.492	0.106	0.212
Hill St	Bedford Rd	Londonderry Cir	0.855	0.893	0.038	0.076
Hill St	Londonderry Cir	Adare Rd	0.893	0.935	0.042	0.084
Hill St	Adare Rd	Sheridan Dr	0.935	1.047	0.112	0.224
Hill St	Sheridan Dr	Shannondale Rd	1.047	1.112	0.065	0.130
Hill St	Shannondale Rd	Hawthorne Rd	1.112	1.157	0.045	0.090
Hill St	Hawthorne Rd	Melrose Ave	1.157	1.255	0.098	0.196
Hilltop Dr	Gralake Ave	Gralake Ave	0.000	0.227	0.227	0.454
King George Blvd	Alpine Dr	Tacoma Cir	0.000	0.036	0.036	0.072
King George Blvd	Tacoma Cir	Alpine Dr	0.036	0.057	0.021	0.042
King George Blvd	Alpine Dr	Wexford Ct	0.057	0.096	0.039	0.078
King George Blvd	Wexford Ct	Brentwood Ct	0.096	0.153	0.057	0.114
King George Blvd	Brentwood Ct	Tacoma Cir	0.153	0.194	0.041	0.082
King George Blvd	Tacoma Cir	Baylis Dr	0.194	0.305	0.111	0.222
King George Blvd	Baylis Dr	Lockridge St	0.305	0.362	0.057	0.114
King George Blvd	Lockridge St	E Eisenhower Pkwy	0.362	0.515	0.153	0.306
Kuehnle St	Beginning of Pavement	W Sequoia Pkwy	0.276	0.306	0.030	0.060
Highland Rd	Awixa Rd	End of Rd Segment	0.160	0.205	0.045	0.090
Lakewood Dr	Sunnywood Dr/Parklake Ave	Mohawk Ave	0.000	0.072	0.072	0.144
Lans Way	Delaware Dr	Ascot St	0.000	0.092	0.092	0.184
Lans Way	Ascot St	Worthington Pl	0.092	0.175	0.083	0.166
Lans Way	Worthington Pl	S 7th St	0.175	0.282	0.107	0.214
Lincoln Ave	Brooklyn Ave	Granger Ave	0.131	0.194	0.063	0.126

Street Crack Treatment - 2017 (Phase 2)

Street Name	Limits		Beginning Milepoint	Ending Milepoint	Length (miles)	
	Beginning	Ending			Centerline	Lane
Londonderry Cir	Londonderry Rd	Dead End or Start	0.000	0.041	0.041	0.082
Manor Dr	Stellar St	Pontiac Trl	0.248	0.304	0.056	0.112
Marian Ave	Glen Leven Rd	W Stadium Blvd	0.000	0.263	0.263	0.526
Meadowside Dr	Woodcreek Dr	Brian Ct	0.000	0.139	0.139	0.278
Meadowside Dr	Brian Ct	Algebe Way	0.139	0.223	0.084	0.168
Meadowside Dr	Algebe Way	Creek Bend Ct	0.223	0.290	0.067	0.134
Melrose Ave	Belmont Rd/Tuomy Rd	Tuomy Rd	0.220	0.253	0.033	0.066
Mills Ct	Override Dr	Dead End or Start	0.000	0.056	0.056	0.112
Morehead Dr	Churchill Dr	Dundee Dr	0.000	0.072	0.072	0.144
Morehead Dr	Dundee Dr	Mershon Dr	0.072	0.129	0.057	0.114
Morehead Dr	Mershon Dr	Newbury Ct	0.129	0.215	0.086	0.172
Morehead Dr	Picadilly Cir	Morehead Ct/S 7th St	0.301	0.367	0.066	0.132
Mount Pleasant Ave	Sunnyside Blvd	Manhattan Dr	0.000	0.150	0.150	0.300
Mount Pleasant Ave	Manhattan Dr	Mount Vernon Ave	0.150	0.308	0.158	0.316
Mount Pleasant Ave	Mount Vernon Ave	W Madison St/Eberwhite Blvd	0.308	0.317	0.009	0.018
N Revena Blvd	Linwood Ave	Harbrooke Ave	0.356	0.449	0.093	0.186
Naples Ct	Snyder Ave/Algonac St	Dead End or Start	0.000	0.078	0.078	0.156
Nottingham Rd	Manchester Rd	Independence Blvd	0.000	0.054	0.054	0.108
Nottingham Rd	Yorkshire Rd	Medford Rd	0.102	0.146	0.044	0.088
Orchard Hills Dr	E Haven St	Avalon Pl	0.000	0.047	0.047	0.094
Palomar Dr	Las Vegas Dr	Granada Ave	0.000	0.067	0.067	0.134
Palomar Dr	Granada Ave	Catalina Dr	0.067	0.127	0.060	0.120
Patricia Ave	Kelly Green Dr	Kelly Green Dr	0.326	0.360	0.034	0.068
Pinebluff Ct	Hickory Point Dr	Dead End or Start	0.000	0.046	0.046	0.092
Pineview Ct	Riverview Dr	Dead End or Start	0.000	0.076	0.076	0.152
Pomona Rd	Miller Rd	Loyola Dr	0.000	0.062	0.062	0.124
Potter Ave	Belmar Pl	S Main St	0.348	0.471	0.123	0.246
Raymond St	Arbordale Dr	Dead End or Start	0.000	0.087	0.087	0.174
Riverview Dr	Dover Pl	Huntington Pl	0.070	0.238	0.168	0.336
Riverview Dr	Indian River Pl	Pineview Ct	0.536	0.692	0.156	0.312
Robin Rd	Bydding Rd	Fountain St	0.000	0.104	0.104	0.208
S 5th Ave	Beakes St	E Summit St	0.987	1.106	0.119	0.238
S Forest Ave	Granger Ave	Woodlawn Ave	0.000	0.101	0.101	0.202
S Forest Ave	Woodlawn Ave	Wells St	0.101	0.174	0.073	0.146

Street Crack Treatment - 2017 (Phase 2)

Street Name	Limits		Beginning Milepoint	Ending Milepoint	Length (miles)	
	Beginning	Ending			Centerline	Lane
S Forest Ave	Wells St/Prospect Ave	Horman Ct	0.000	0.045	0.045	0.090
S Forest Ave	Horman Ct	Minerva Rd	0.045	0.086	0.041	0.082
S Forest Ave	Minerva Rd	Roosevelt Ct	0.086	0.155	0.069	0.138
S Forest Ave	Cambridge Rd	Oakland Ave	0.194	0.240	0.046	0.092
S Forest Ave	Oakland Ave	Hill St	0.240	0.364	0.124	0.248
S Franklin Ct	Franklin St	Dead End or Start	0.000	0.046	0.046	0.092
S Kearney Rd	Shannondale Rd	Melrose Ave	0.105	0.207	0.102	0.204
Scio Church Rd Service Dr	Chaucer Dr	Scio Church Rd	0.305	0.399	0.094	0.188
Glenwood Service Dr	Arlington Blvd	Glenwood Service Dr	0.000	0.067	0.067	0.134
Glenwood Service Dr	Glenwood Service Dr	Override Dr	0.067	0.346	0.279	0.558
Shady Ln	Packard St	Shady Ln	0.000	0.033	0.033	0.066
Shady Ln	Shady Ln	Shady Ln	0.033	0.134	0.101	0.202
Shady Ln	Shady Ln	Shady Ln	0.000	0.099	0.099	0.198
Shamrock Ct	Hickory Point Dr	Dead End or Start	0.000	0.066	0.066	0.132
Snyder Ave	Edgewood Ave	Prescott Ave	0.225	0.303	0.078	0.156
Snyder Ave	Hutchins Ave	S 7th St	0.366	0.429	0.063	0.126
Snyder Ave	Crosby Cres	Naples Ct/Algonac St	0.556	0.688	0.132	0.264
Stadium Ct	Dead End or Start	W Stadium Blvd	0.000	0.052	0.052	0.104
Stellar St	Manor Dr	Cloverdale St	0.000	0.081	0.081	0.162
Sunnywood Dr	Dolph Dr	Lakewood Dr/Parklake Ave	0.362	0.484	0.122	0.244
Thaler Ave	Carolina Ave	Garden Cir	0.154	0.193	0.039	0.078
Tuomy Rd	Washtenaw Ave	Belmont Rd	0.000	0.163	0.163	0.326
Tuomy Rd	Belmont Rd	Melrose Ave	0.163	0.212	0.049	0.098
Ventura Ct	Bemidji Dr	Dead End or Start	0.000	0.024	0.024	0.048
Verle Ave	Marshall St	Platt Rd	0.293	0.389	0.096	0.192
Vinewood Blvd	Washtenaw Ave	Wayne St	0.000	0.134	0.134	0.268
Vinewood Blvd	Wayne St	Berkshire Rd	0.134	0.259	0.125	0.250
W Davis Ave	3rd St	Wilder Pl	0.251	0.280	0.029	0.058
W Sequoia Pkwy	Patricia Ave	N Maple Rd/N Circle Dr	0.425	0.507	0.082	0.164
Waltham Dr	Kent St	Warwick Ct	0.076	0.132	0.056	0.112
Waltham Dr	Saxon Rd	Kent St	0.228	0.334	0.106	0.212
Wells St	Martin Pl	Baldwin Ave	0.364	0.432	0.068	0.136
Wesley Ave	Harbrooke Ave	Arborview Blvd	0.085	0.204	0.119	0.238
Western Dr	S Circle Dr	N Circle Dr	0.000	0.222	0.222	0.444

Street Crack Treatment - 2017 (Phase 2)

Street Name	Limits		Beginning Milepoint	Ending Milepoint	Length (miles)	
	Beginning	Ending			Centerline	Lane
Westminster Pl	Gardner Ave	Brooklyn Ave	0.151	0.197	0.046	0.092
White St	Stimson St	Henry St	0.000	0.064	0.064	0.128
White St	Henry St	E Stadium Blvd	0.064	0.125	0.061	0.122
Wilder Pl	W Hoover Ave	Wilder Pl	0.000	0.023	0.023	0.046
Winewood Ave	Burwood Ave	Carolina Ave	0.000	0.029	0.029	0.058
Worden Ave	Jackson Pl	Dexter Ave	0.014	0.182	0.168	0.336
PHASE 2 MAJOR STREETS					12.121	30.242
PHASE 2 MINOR (LOCAL) STREETS					11.739	23.478
PHASE 2 TOTAL					23.860	53.720

City of Ann Arbor Street Crack Treatment – 2017



Addendum-1-51

Phase 1A Location Map - Minor (Local) Streets



City of Ann Arbor Street Crack Treatment – 2017



Addendum-1-52

Phase 1B Location Map - Minor (Local) Streets

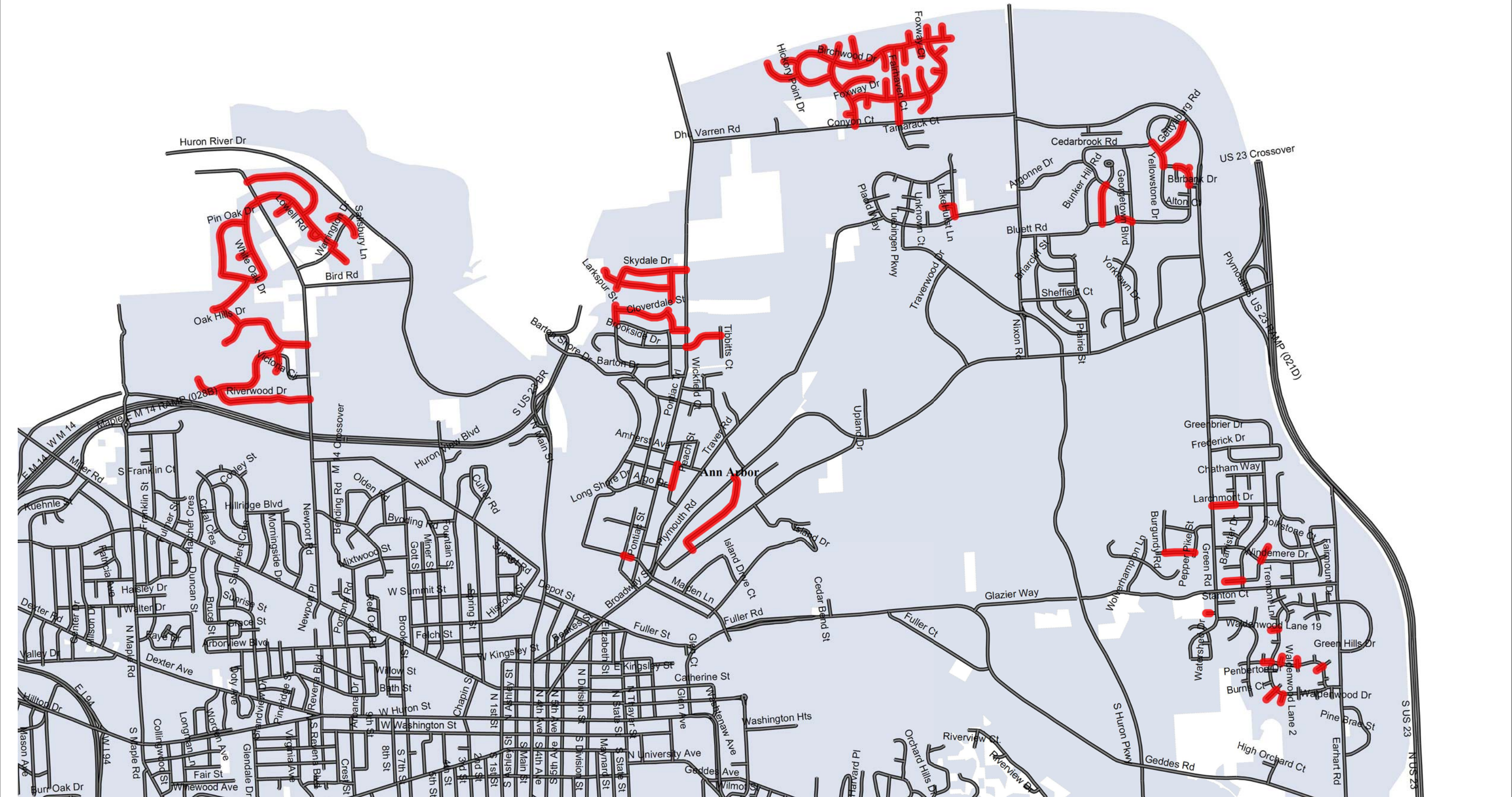

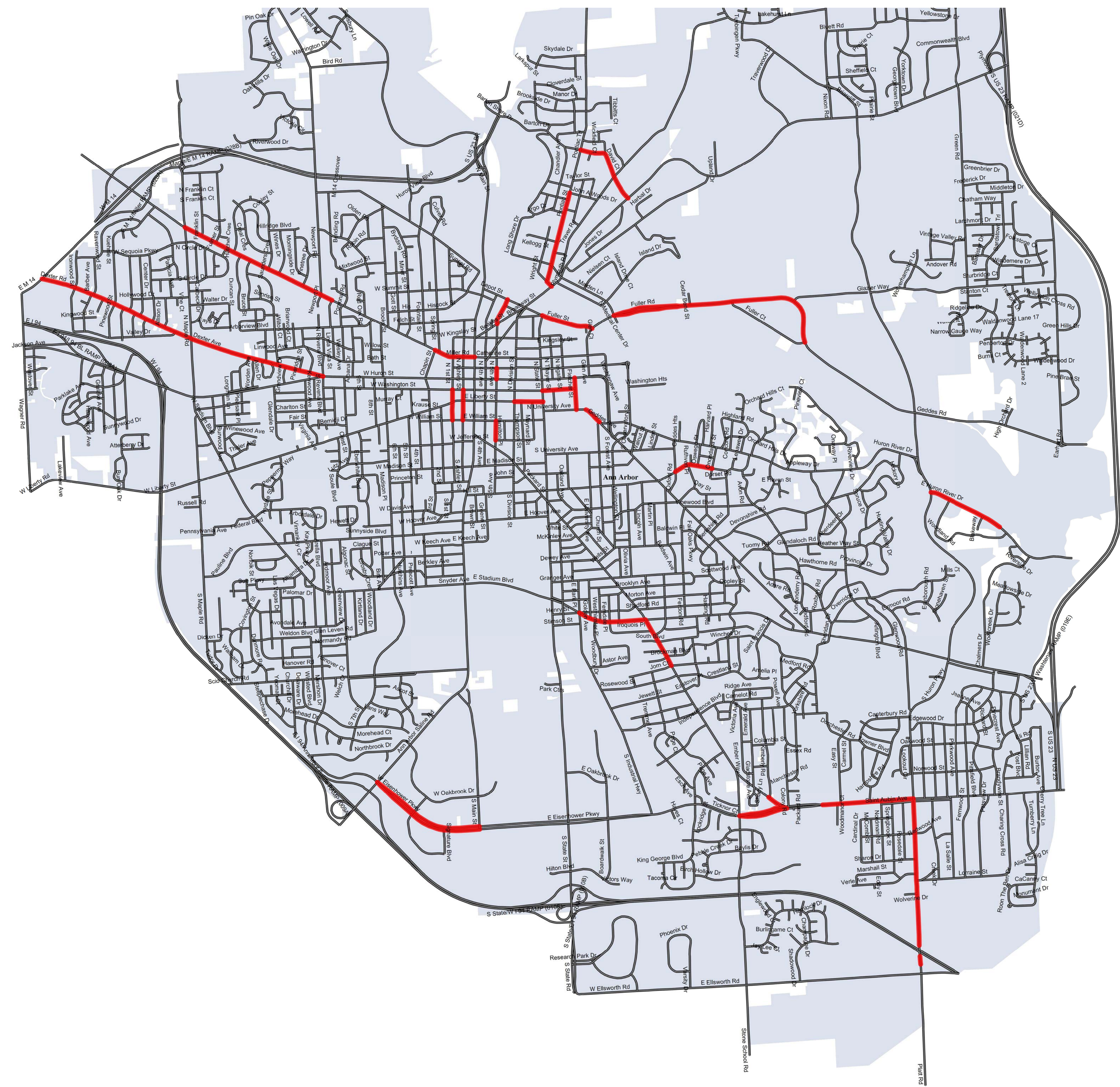

Phase 2 Location Map - Local Streets

