

CITY OF ANN ARBOR
INVITATION TO BID



**Fiber and Conduit Construction for the
Ann Arbor/Ypsilanti Broadband Project**

**ITB No. 4754
EDA Award No. 06-79-06299**

Due Date: February 27, 2025 by 11:00 AM (Local Time)

Information Technology Service Unit

Issued By:

City of Ann Arbor
Procurement Unit
301 E. Huron Street
Ann Arbor, MI 48104



TABLE OF CONTENTS

TABLE OF CONTENTS	2
ATTACHMENTS	2
INSTRUCTIONS TO BIDDERS	3
INVITATION TO BID	12
BID FORM	46
PERFORMANCE BOND	49
SAMPLE STANDARD CONTRACT	59
GENERAL CONDITIONS	67
STANDARD SPECIFICATIONS	69
A. General Requirements	87
B. Construction Restoration	88
C. Utility Engineering Fees and Permits	89
D. Make Ready Fees	89
E. Cable Pulling	89
F. Cable Lubricant	90
G. Cable Splicing	90
H. Labeling and Identification	90
I. Aerial Construction Requirements (If applicable)	90
J. Underground Construction Requirements	91
K. Above-Ground Cabinet Construction	91
L. Materials Specifications	91
M. Acceptance and Testing	93
N. Splice Testing Documentation	94
O. Documentation	94
P. Warranty and Workmanship	94
CITY OF ANN ARBOR	95
LIVING WAGE ORDINANCE DECLARATION OF COMPLIANCE	96

APPENDIX..... APDX-1

Appendix 1

Appendix 2

Appendix 3 - EDA Standard Terms and Conditions for Construction Projects

Appendix 4

North Route, East Plan

North Route, West Plan

South Route, East Plan

South Route, West Plan

Permit Summary

Wage Determination General Decision Number: MI20240001 12/06/2024

ATTACHMENTS

City of Ann Arbor Prevailing Wage Declaration Form

City of Ann Arbor Living Wage Forms

City of Ann Arbor Vendor Conflict of Interest Disclosure Form

City of Ann Arbor Non-Discrimination Ordinance Declaration Form and Notice

INSTRUCTIONS TO BIDDERS

General

Work to be done under this Contract is described in sections General Scope of Work, Detailed Specifications for the Fiber and Conduit Construction for the Ann Arbor-Ypsilanti Broadband Project, Standard Specifications, EDA Standard Terms and Conditions for Construction Projects, and Architect/Engineering Route Plan and must be completed fully in accordance with the contract documents. All work to be done under this Contract is located in the City of Ann Arbor and the City of Ypsilanti.

The City of Ann Arbor's Procurement Office is soliciting bids for the construction of an underground fiber optic and conduit backbone from the City of Ann Arbor to the City of Ypsilanti. Architect/engineering plans and permitting for the route has been completed under RFP #22-24 and is included in this ITB.

Any Bid which does not conform fully to these instructions may be rejected.

U.S. Department of Commerce Economic Development Administration Federal Funding

Ann Arbor Spark, the City of Ann Arbor, and the City of Ypsilanti have received a U.S. Department of Commerce's Economic Development Administration (EDA) financial assistance investment award from the Economic Adjustment Assistance – FY 2020 CARES Act Supplemental Notice of Funding Opportunity for the Ann Arbor-Ypsilanti Broadband Project to design, engineer and construct approximately 20-miles of new underground fiber and conduit to-and-from the City of Ann Arbor and the City of Ypsilanti. Outside plant (OSP) network design, fiber and conduit route planning, permitting services, and architect/engineering design services and documentation have been completed. This project will be partially funded with Federal funds from the United States Department of Commerce, Economic Development Administration and therefore is subject to the Federal laws and regulations associated with that program. The final Architect/Engineering Route Plan is in Appendix 4.

EDA grant funds will be used, in whole or in part, for work and services contracted pursuant to this ITB. The contract approved will include the EDA Standard Terms and Conditions for Construction Projects (March 2021) which contains additional terms and conditions required by the EDA in addition to those outlined in the sample City contract attached hereto.

Contractor will be expected to comply with all applicable federal, state, and local regulations. If a contract is awarded, the selected contractor will be required to register in SAM.gov and provide a Unique Entity ID number to the City prior to contract execution.

Bidders should note that while the contract for the project will be with the City of Ann Arbor, which will administer the project and contract, the contract will specify that payments to contractor will be paid by Ann Arbor SPARK in accordance with the Memorandum of Understanding between the City of Ann Arbor, Ann Arbor SPARK, and the City of Ypsilanti.

Bidders are encouraged to closely review the sample contract and the following documents, all of which are attached hereto:

- EDA Financial Assistance Award Form CD-450 Federal Award ID Number 06-79-06299 – URI: 116132
- EDA Investment Award Letter for Investment No. 06-79-6299
- EDA Standard Terms and Conditions for Construction Projects (March 2021)
- Memorandum of Understanding between City of Ann Arbor, Ann Arbor SPARK, and City of Ypsilanti dated February 7, 2022

The City of Ann Arbor is seeking qualified contractors to construct the underground fiber optic and conduit backbone. Project scope is subject to the EDA financial assistance investment award and the City of Ann Arbor reserves the right to change the project scope for any reason. Alternate construction, efficiencies and changes are welcome.

General Project Requirements

- Construction must adhere to the EDA Standard Terms and Conditions for Construction Projects in Appendix 3.
- Conduit will be constructed utilizing directional boring at a minimum depth of 48” inches.
- Minimum vertical and horizontal separations will be maintained with existing utilities, as required by each permitting agency with jurisdiction over the project.
- Conduit configuration consists of (2) 2” HDPE SDR11 duct. In one of the two ducts, a single 432-count loose-tube fiber-optic cable will be installed and spliced.
- Installation of composite tier 22 underground vaults sized at 30” by 48” by 36” within existing rights of way.
- Vaults are planned at intervals of no more than 800’.
- All vaults must have a tier 22 load rating.
- All vaults will house 50’ – 150’ of fiber optic cable slack.
- A #12 AWG insulated tracer wire will be pulled inside one of the two 2” conduits for underground utility locating purposes. Tracer wire will be grounded with 5/8”x8’ copper clad ground rods.
- All fiber-optic splice cases shall be Commscope gel sealed 450D sized closures. Closures are 30” long and are capable of housing up to 576 single fusions splices. Splice cases shall be loaded with splice trays capable of holding 24 single fusion fiber splices with protective sleeves.
- Project construction must comply with City of Ann Arbor Fiber & Conduit Design and Construction Detailed Technical General and Detailed Specifications located in this ITB unless otherwise authorized by the City of Ann Arbor.
- The City fiber network utilizes Corning products and carries a 25-year Corning warranty. This design must adhere to Corning standards and must be certified by the contractor once construction is completed.
- The fiber/conduit routes will intersect and utilize existing City infrastructure (i.e. conduit, fiber) to extend the fiber to the City of Ann Arbor Data Center.
- Proposed fiber optic network design is all underground construction, unless otherwise approved by the City of Ann Arbor.
- Provide as-built documentation to the project Architect and Engineering contractor and the City.
- Design drawings must be compatible with and ready for use in ESRI’s ArcGIS software, specifically in shapefile format or feature class files contained inside a file geodatabase. Design drawings must also be correctly georeferenced (i.e., all elements of the drawing must be comprised of coordinate points or geometry that correctly correspond to the coordinates of their real-world counterparts) and to scale.

- Required projected coordinate system for use is “NAD 1983 StatePlane Michigan South FIPS 2113 (Intl Feet)” (WKID 2253).
- The contractor is required to provide, consolidated field notes and electronically store in a format approved by the City of Ann Arbor.
- The City requires the use of Corning ALTOS® Lite Gel-Free, Single-Jacket, Single-Armored Cables, 6-432 Optical Fiber that is compliant with the new International Telecommunication Union (ITU) standards for low water-peak fibers, ITU G.652.C, as well as Telecommunications Industry Association and Electronic Industries Alliance (TIA/EIA) standards.
- Conduits entering handholes through the sidewall (as opposed to being swept up and entering from the bottom) that the hole in the wall of the handhole must be sealed with concrete to prevent dirt and debris from entering the handhole. This includes new handholes or connecting into existing handholes.
- Any vacant conduits must be plugged/sealed.
- In the absence of explicit specifications contained within in this ITB, contractor must adhere to industry best practice and follow all applicable local, state, and federal regulations, including bonding and grounding guidelines and requirements.
- Permitting is being managed by the project Architect/Engineering contractor.
- Contractor Project Management:
 - Contractor must assign a Project Manager to all projects and utilize industry standard project management methodologies to ensure projects are deliver within budget and on time.
 - Maintain an up-to-date project plan that reflects the current state of the project.
 - Work closely with the City’s Project Manager to ensure project success.
 - Conduct and attend regularly scheduled status meetings.
 - Mitigate and escalate issues to executive stakeholders and project team.
 - Manage the change order process.
- The City of Ann Arbor Project Management will:
 - Upon award of the contract, the City will provide mapped and electronic information about existing infrastructure including information about City owned conduit and fiber.
 - Provide access to City-owned streetlights and poles, if applicable.
 - The City will help ensure access to existing infrastructure where appropriate.
 - If applicable, as a pole owner, in instances where there is useable, excess space and capacity on the pole, the City of Ann Arbor may be able to reallocate pole space. If feasible, the City may choose to install their own pole.
 - Provide access to City-owned property for placement of infrastructure that will permit providers to reach required areas within the City.

Any Bid which does not conform fully to these instructions may be rejected.

Pre-Bid Meeting

A pre-proposal conference for this project will be held on **February 4, 2025 at 1:00PM at Ann Arbor Council Chambers located at 301 E. Huron St.**

Attendance at this conference is highly recommended. Administrative and technical questions regarding this project will be answered at this time. The pre-proposal conference is for information only. Any answers furnished will not be official until verified in writing by the Financial Service Area, Procurement Unit. Answers that change or substantially clarify the proposal will be affirmed in an addendum.

Preparation of Bids

Bids should be prepared providing a straight-forward, concise description of the Bidder's ability to meet the requirements of the ITB. Bids shall be written in ink or typewritten. No erasures are permitted. Mistakes may be crossed out and corrected and must be initialed and dated in ink by the person signing the Bid.

Bids must be submitted on the "Bid Forms" provided with each blank properly filled in. If forms are not fully completed it may disqualify the bid. No alternative bid will be considered unless alternative bids are specifically requested. If alternatives are requested, any deviation from the specification must be fully described, in detail on the "Alternate" section of Bid form.

Each person signing the Bid certifies that he/she is the person in the Bidder's firm/organization responsible for the decision as to the fees being offered in the Bid and has not and will not participate in any action contrary to the terms of this provision.

Bid Security

Each bid must be accompanied by a certified check or Bid Bond by a surety licensed and authorized to do business within the State of Michigan, in the amount of 5% of the total of the bid price.

Questions or Clarifications / Designated City Contacts

All questions regarding this ITB shall be submitted via email. Emailed questions and inquires will be accepted from any and all prospective Bidders in accordance with the terms and conditions of the ITB.

All questions shall be due on or before **February 7, 2025 at 4:00 PM (local time)** and should be addressed as follows:

Specification/Scope of Work questions emailed to IT-RFPS@a2gov.org
Bid Process and Compliance questions emailed to cspencer@a2gov.org

Should any prospective bidder be in doubt as to the true meaning of any portion of this ITB, or should the prospective bidder find any ambiguity, inconsistency, discrepancy, or omission therein, the prospective bidder shall make a written request for an official interpretation or correction by the due date for questions above.

Any errors, omissions or discrepancies in the specification discovered by a prospective contractor and/or service provider shall be brought to the attention of Colin Spencer at cspencer@a2gov.org as soon after discovery as possible. Further, the contractor and/or service provider shall not be allowed to take advantage of errors, omissions, or discrepancies in the specifications.

All interpretations, corrections, or additions to this ITB will be made only as an official addendum that will be posted to a2gov.org and MITN.info and it shall be the prospective bidder's responsibility to ensure they have received all addenda before submitting a proposal. Any addendum issued by the City shall become part of the ITB must be incorporated in the proposal where applicable.

Addenda

If it becomes necessary to revise any part of the ITB, notice of the Addendum will be posted to

Michigan Inter-governmental Trade Network (MITN) www.mitn.info and/or City of Ann Arbor web site www.A2gov.org for all parties to download.

Each Bidder must in its Bid, to avoid any miscommunications, acknowledge all addenda which it has received; but the failure of a Bidder to receive, or acknowledge receipt of; any addenda shall not relieve the Bidder of the responsibility for complying with the terms thereof.

The City will not be bound by oral responses to inquiries or written responses other than written addenda.

Bid Submission

All Bids are due and must be delivered to the City of Ann Arbor Procurement Unit on or before February 27, 2025 by 11:00 AM (local time). Bids submitted late or via oral, telephonic, telegraphic, electronic mail or facsimile **will not** be considered or accepted.

Each Bidder should submit one (1) original Bid in a sealed envelope clearly marked: ITB# **4754**.
- Fiber and Conduit Construction for the Ann Arbor/Ypsilanti Broadband Project

Bids must be addressed and delivered to:

City of Ann Arbor
Procurement Unit,
c/o Customer Services, 1st Floor
301 East Huron Street
Ann Arbor, MI 48104

All Bids received on or before the Due Date will be publicly opened and recorded immediately. No immediate decisions are rendered.

The following forms provided within this ITB Document should be included in submitted bids.

- **City of Ann Arbor Prevailing Wage Declaration of Compliance**
- **City of Ann Arbor Living Wage Ordinance Declaration of Compliance**
- **Vendor Conflict of Interest Disclosure Form**
- **City of Ann Arbor Non-Discrimination Ordinance Declaration of Compliance**

Bids that fail to provide these forms listed above upon bid opening may be rejected as non-responsive and may not be considered for award.

Hand delivered bids may be dropped off in the Purchasing drop box located in the Ann Street (north) vestibule/entrance of City Hall which is accessible to the public at all hours. The City will not be liable to any Bidder for any unforeseen circumstances, delivery or postal delays. Postmarking to the Due Date will not substitute for receipt of the Bid. Each Bidder is responsible for submission of their Bid.

Additional time for submission of bids past the stated due date and time will not be granted to a single Bidder; however, additional time may be granted to all Bidders when the City determines in its sole discretion that circumstances warrant it.

Award

The City intends to award a Contract(s) to the lowest responsible Bidder(s). On multi-divisional contracts, separate divisions may be awarded to separate Bidders. The City may also utilize alternatives offered in the Bid Forms, if any, to determine the lowest responsible Bidder on each division, and award multiple divisions to a single Bidder, so that the lowest total cost is achieved for the City. For unit price bids, the Contract will be awarded based upon the unit prices and the lump sum prices stated by the bidder for the work items specified in the bid documents, with consideration given to any alternates selected by the City. If the City determines that the unit price for any item is materially different for the work item bid than either other bidders or the general market, the City, in its sole discretion, in addition to any other right it may have, may reject the bid as not responsible or non-conforming.

The acceptability of major subcontractors will be considered in determining if a Bidder is responsible. In comparing Bids, the City will give consideration to alternate Bids for items listed in the bid forms. All key staff and subcontractors are subject to the approval by the City.

Official Documents

The City of Ann Arbor officially distributes bid documents from the Procurement Unit or through the Michigan Intergovernmental Trade Network (MITN). Copies of the bid documents obtained from any other source are not Official copies. Addenda and other bid information will only be posted to these official distribution sites. If you obtained City of Ann Arbor Bid documents from other sources, it is recommended that you register on www.MITN.info and obtain an official Bid. Bidders do not need to be shown on the plan holders list provided by MITN to be considered an official plan holder.

Withdrawal of Bids

After the time of opening, no Bid may be withdrawn for the period of ninety (90) days.

Contract Time

Time is of the essence in the performance of the work under this Contract. The available time for work under this Contract is indicated on page C-2, Article III of the Contract. If these time requirements cannot be met, the Bidder must stipulate on Bid Form Section 3 - Time Alternate its schedule for performance of the work. Consideration will be given to time in evaluating bids.

Liquidated Damages

A liquidated damages clause, as given on page C-2, Article III of the Contract, provides that the Contractor shall pay the City as liquidated damages, and not as a penalty, a sum certain per day for each and every day that the Contractor may be in default of completion of the specified work, within the time(s) stated in the Contract, or written extensions.

Liquidated damages clauses, as given in the General Conditions, provide further that the City shall be entitled to impose and recover liquidated damages for breach of the obligations under Chapter 112 of the City Code.

The liquidated damages are for the non-quantifiable aspects of any of the previously identified events and do not cover actual damages that can be shown or quantified nor are they intended to preclude recovery of actual damages in addition to the recovery of liquidated damages.

Human Rights Information

All contractors proposing to do business with the City shall satisfy the contract compliance administrative policy adopted by the City Administrator in accordance with the Section 9:158 of the Ann Arbor City Code. Breach of the obligation not to discriminate as outlined in Section 5, beginning at page GC-2 shall be a material breach of the contract. Contractors are required to post a copy of Ann Arbor's Non-Discrimination Ordinance attached at all work locations where its employees provide services under a contract with the City.

Wage Requirements

Section 4, beginning at page GC-1, outlines the requirements for payment of prevailing wages and for payment of a "living wage" to employees providing service to the City under this contract. The successful bidder and its subcontractors must comply with all applicable requirements and provide proof of compliance.

Pursuant to Resolution R-16-469 all public improvement contractors are subject to prevailing wage and will be required to provide to the City payroll records sufficient to demonstrate compliance with the prevailing wage requirements. Use of the Sample Certified Payroll form provided in the Appendix section or a City-approved equivalent will be required along with wage rate interviews.

For laborers whose wage level are subject to federal, state and/or local prevailing wage law the appropriate Davis-Bacon wage rate classification is identified based upon the work including within this contract. The U.S. Department of Labor (DOL) has provided explanations to assist with classification in the following resource link: SAM.gov. Davis-Bacon language is as follows:

General Decision Number: MI20240001 12/06/2024

Superseded General Decision Number: MI20230001

State: Michigan

Construction Types: Highway (Highway, Airport & Bridge xxxxx and Sewer/Incid. to Hwy.)

Counties: Michigan Statewide.

Note: Contracts subject to the Davis-Bacon Act are generally required to pay at least the applicable minimum wage rate required under Executive Order 14026 or Executive Order 13658. Please note that these Executive Orders apply to covered contracts entered into by the federal government that are subject to the Davis-Bacon Act itself, but do not apply to contracts subject only to the Davis-Bacon Related Acts, including those set forth at 29 CFR 5.1(a)(1).

If the contract is entered into on or after January 30, 2022, or the contract is	. Executive Order 14026 generally applies to the contract.
--	--

renewed or extended (e.g., an option is exercised) on or after January 30, 2022:	. The contractor must pay all covered workers at least \$17.20 per hour (or the applicable wage rate listed on this wage determination, if it is higher) for all hours spent performing on the contract in 2024.
If the contract was awarded on or between January 1, 2015 and January 29, 2022, and the contract is not renewed or extended on or after January 30, 2022:	. Executive Order 13658 generally applies to the contract. . The contractor must pay all covered workers at least \$12.90 per hour (or the applicable wage rate listed on this wage determination, if it is higher) for all hours spent performing on that contract in 2024.

The applicable Executive Order minimum wage rate will be adjusted annually. If this contract is covered by one of the Executive Orders and a classification considered necessary for performance of work on the contract does not appear on this wage determination, the contractor must still submit a conformance request.

Additional information on contractor requirements and worker protections under the Executive Orders is available at <http://www.dol.gov/whd/govcontracts>.

Modification Number	Publication Date
0	01/05/2024
1	02/23/2024
2	04/05/2024
3	04/19/2024
4	04/26/2024
5	05/03/2024
6	05/17/2024
7	05/24/2024
8	06/07/2024
9	06/14/2024
10	06/28/2024
11	07/12/2024
12	07/26/2024
13	08/02/2024

14	08/23/2024
15	10/11/2024
16	11/22/2024
17	12/06/2024

CARP0004-004 06/01/2019

REMAINDER OF STATE

	Rates	Fringes
CARPENTER (Piledriver).....	\$ 27.62	20.59

CARP0004-005 06/01/2018		

LIVINGSTON (Townships of Brighton, Deerfield, Genoa, Hartland, Oceola & Tyrone), MACOMB, MONROE, OAKLAND, SANILAC, ST. CLAIR AND WAYNE COUNTIES

	Rates	Fringes
CARPENTER (Piledriver).....	\$ 30.50	27.28

ELEC0017-005 06/01/2024		

STATEWIDE

	Rates	Fringes
Line Construction		
Groundman/Driver.....	\$ 32.00	33%+7.31
Journeyman Signal Tech, Communications Tech, Tower		
Tech & Fiber Optic Splicers..	\$ 47.35	33%+7.31
Journeyman Specialist.....	\$ 54.45	33%+7.31
Operator A.....	\$ 40.09	33%+7.31
Operator B.....	\$ 37.46	33%+7.31

Classifications

Journeyman Specialist: Refers to a crew of only one person working alone.

Operator A: Shall be proficient in operating all power equipment including: Backhoe, Excavator, Directional Bore and Boom/Digger truck.

Operator B: Shall be proficient in operating any 2 of the above mentioned pieces of equipment listed under Operator A.

ENGI0324-003 06/01/2024

ALCONA, ALPENA, ARENAC, BAY, CHEBOYGAN, CLARE, CLINTON,
CRAWFORD, GENESEE, GLADWIN, GRATIOT, HURON, INGHAM, IOSCO,
ISABELLA, JACKSON, LAPEER, LENAWEE, LIVINGSTON, MACOMB,
MIDLAND, MONROE, MONTMORENCY, OAKLAND, OGEMAW, OSCODA, OTSEGO,
PRESQUE ISLE, ROSCOMMON, SAGINAW, ST. CLAIR, SANILAC,
SHIAWASSEE, TUSCOLA, WASHTENAW AND WAYNE COUNTIES:

	Rates	Fringes
OPERATOR: Power Equipment (Steel Erection)		
GROUP 1.....	\$ 55.42	25.25
GROUP 2.....	\$ 56.42	25.25
GROUP 3.....	\$ 53.92	25.25
GROUP 4.....	\$ 54.92	25.25
GROUP 5.....	\$ 52.42	25.25
GROUP 6.....	\$ 53.42	25.25
GROUP 7.....	\$ 52.15	25.25
GROUP 8.....	\$ 53.15	25.25
GROUP 9.....	\$ 51.70	25.25
GROUP 10.....	\$ 52.70	25.25
GROUP 11.....	\$ 50.97	25.25
GROUP 12.....	\$ 51.97	25.25
GROUP 13.....	\$ 50.61	25.25
GROUP 14.....	\$ 51.61	25.25
GROUP 15.....	\$ 49.97	25.25
GROUP 16.....	\$ 46.77	25.25
GROUP 17.....	\$ 32.29	12.40
GROUP 18.....	\$ 35.78	25.25

FOOTNOTE:

Paid Holidays: New Year's Day, Memorial Day, Fourth of July,
Labor Day, Thanksgiving Day and Christmas Day.

POWER EQUIPMENT OPERATOR CLASSIFICATIONS

GROUP 1: Engineer when operating combination of boom and jib
400' or longer

GROUP 2: Engineer when operating combination of boom and jib
400' or longer on a crane that requires an oiler

GROUP 3: Engineer when operating combination of boom and jib
300' or longer

GROUP 4: Engineer when operating combination of boom and jib 300' or longer on a crane that requires an oiler

GROUP 5: Engineer when operating combination of boom and jib 220' or longer

GROUP 6: Engineer when operating combination of boom and jib 220' or longer on a crane that requires an oiler

GROUP 7: Engineer when operating combination of boom and jib 140' or longer

GROUP 8: Engineer when operating combination of boom and jib 140' or longer on a crane that requires an oiler

GROUP 9: Tower crane & derrick operator (where operator's work station is 50 ft. or more above first sub-level)

GROUP 10: Tower crane & derrick operator (where operator's work station is 50 ft. or more above first sub-level) on a crane that requires an oiler

GROUP 11: Engineer when operating combination of boom and jib 120' or longer

GROUP 12: Engineer when operating combination of boom and jib 120' or longer on a crane that requires an oiler

GROUP 13: Crane operator; job mechanic and 3 drum hoist and excavator

GROUP 14: Crane operator on a crane that requires an oiler

GROUP 15: Hoisting operator; 2 drum hoist and rubber tired backhoe

GROUP 16: Forklift and 1 drum hoist

GROUP 17: Compressor or welder operator

GROUP 18: Oiler

ENGI0324-004 06/01/2024

AREA 1: ALLEGAN, BARRY, BERRIEN, BRANCH, CALHOUN, CASS, EATON, HILLSDALE, IONIA, KALAMAZOO, KENT, LAKE, MANISTEE, MASON, MECOSTA, MONTCALM, MUSKEGON, NEWAYGO, OCEANA, OSCEOLA, OTTAWA, ST. JOSEPH, VAN BUREN

AREA 2: ANTRIM, BENZIE, CHARLEVOIX, EMMET, GRAND TRAVERSE,
KALKASKA, LEELANAU, MISSAUKEE AND WEXFORD COUNTIES:

	Rates	Fringes
OPERATOR: Power Equipment (Steel Erection)		
AREA 1		
GROUP 1.....	\$ 55.02	25.25
GROUP 2.....	\$ 52.15	25.25
GROUP 3.....	\$ 50.61	25.25
GROUP 4.....	\$ 46.77	25.25
GROUP 5.....	\$ 32.29	12.40
GROUP 6.....	\$ 35.78	25.25
AREA 2		
GROUP 1.....	\$ 55.02	25.25
GROUP 2.....	\$ 52.15	24.25
GROUP 3.....	\$ 50.61	25.25
GROUP 4.....	\$ 46.77	25.25
GROUP 5.....	\$ 32.29	12.40
GROUP 6.....	\$ 35.78	25.25

FOOTNOTES:

Crane operator with main boom and jib 300' or longer: \$1.50 additional to the group 1 rate. Crane operator with main boom and jib 400' or longer: \$3.00 additional to the group 1 rate.

PAID HOLIDAYS: New Year's Day, Memorial Day, Fourth of July, Labor Day, Thanksgiving Day and Christmas Day.

POWER EQUIPMENT OPERATOR CLASSIFICATIONS:

GROUP 1: Crane Operator with main boom & jib 400', 300', or 220' or longer.

GROUP 2: Crane Operator with main boom & jib 140' or longer, Tower Crane; Gantry Crane; Whirley Derrick.

GROUP 3: Regular Equipment Operator, Crane, Dozer, Loader, Hoist, Straddle Wagon, Mechanic, Grader and Hydro Excavator.

GROUP 4: Air Tugger (single drum), Material Hoist Pump 6" or over, Elevators, Brokk Concrete Breaker.

GROUP 5: Air Compressor, Welder, Generators, Conveyors

GROUP 6: Oiler and fire tender

AREA 1: GENESEE, LAPEER, LIVINGSTON, MACOMB, MONROE, OAKLAND,
ST. CLAIR, WASHTENAW AND WAYNE COUNTIES

AREA 2: ALCONA, ALLEGAN, ALGER, ALPENA, ANTRIM, ARENAC, BARAGA,
BARRY, BAY, BENZIE, BERRIEN, BRANCH, CALHOUN, CASS,
CHARLEVOIX, CHEBOYGAN, CHIPPEWA, CLARE, CLINTON, CRAWFORD,
DELTA, DICKINSON, EATON, EMMET, GLADWIN, GOGEBIC, GRAND
TRAVERSE, GRATIOT, HILLSDALE, HOUGHTON, HURON, INGHAM, IONIA,
IOSCO, IRON, ISABELLA, JACKSON, KALAMAZOO, KALKASKA, KENT,
KWEENAW, LAKE, LEELANAU, LENAWEE, LUCE, MACKINAC, MANISTEE,
MARQUETTE, MASON, MECOSTA, MENOMINEE, MIDLAND, MISSAUKEE,
MONTCALM, MONTMORENCY, MUSKEGON, NEWAYGO, OCEANA, OGEMAW,
ONTONAGON, OSCEOLA, OSCODA, OTSEGO, OTTAWA, PRESQUE ISLE,
ROSCOMMON, SAGINAW, SANILAC, SCHOOLCRAFT, SHIAWASSEE, ST.
JOSEPH, TUSCOLA, VAN BUREN AND WEXFORD COUNTIES

	Rates	Fringes
OPERATOR: Power Equipment (Underground construction (including sewer))		
AREA 1:		
GROUP 1.....	\$ 43.48	25.25
GROUP 2.....	\$ 38.75	25.25
GROUP 3.....	\$ 38.02	25.25
GROUP 4.....	\$ 37.45	25.25
GROUP 5.....	\$ 27.85	12.10
AREA 2:		
GROUP 1.....	\$ 43.48	25.25
GROUP 2.....	\$ 38.75	25.25
GROUP 3.....	\$ 38.02	25.25
GROUP 4.....	\$ 37.45	25.25
GROUP 5.....	\$ 27.85	12.10

POWER EQUIPMENT OPERATOR CLASSIFICATIONS

GROUP 1: Backfiller tamper; Backhoe; Batch plant operator
(concrete); Clamshell; Concrete paver (2 drums or larger);
Conveyor loader (Euclid type); Crane (crawler, truck type
or pile driving); Dozer; Dragline; Elevating grader;
Endloader; Gradall (and similar type machine); Grader;
Mechanic; Power shovel; Roller (asphalt); Scraper
(self-propelled or tractor drawn); Side boom tractor (type
D-4 or equivalent and larger); Slip form paver; Slope
paver; Trencher (over 8 ft. digging capacity); Well
drilling rig; Concrete pump with boom operator; Hydro

Excavator

GROUP 2: Boom truck (power swing type boom); Crusher; Hoist; Pump (1 or more - 6-in. discharge or larger - gas or diesel- powered or powered by generator of 300 amperes or more - inclusive of generator); Side boom tractor (smaller than type D-4 or equivalent); Tractor (pneu-tired, other than backhoe or front end loader); Trencher (8-ft. digging capacity and smaller); Vac Truck and End dump operator;

GROUP 3: Air compressors (600 cfm or larger); Air compressors (2 or more-less than 600 cfm); Boom truck (non-swinging, non- powered type boom); Concrete breaker (self-propelled or truck mounted - includes compressor); Concrete paver (1 drum-1/2 yd. or larger); Elevator (other than passenger); Maintenance person; Pump (2 or more-4-in. up to 6-in. discharge-gas or diesel powered - excluding submersible pumps); Pumpcrete machine (and similar equipment); Wagon drill (multiple); Welding machine or generator (2 or more-300 amp. or larger - gas or diesel powered)

GROUP 4: Boiler; Concrete saw (40 hp or over); Curing machine (self-propelled); Farm tractor (with attachment); Finishing machine (concrete); Hydraulic pipe pushing machine; Mulching equipment; Pumps (2 or more up to 4-in. discharge, if used 3 hours or more a day, gas or diesel powered - excluding submersible pumps); Roller (other than asphalt); Stump remover; Trencher (service); Vibrating compaction equipment, self-propelled (6 ft. wide or over); Sweeper (Wayne type); Water wagon and Extend-a boom forklift

Group 5: Fire Person, Oiler

* ENGI0324-006 06/01/2024

GENESEE, MACOMB, MONROE, OAKLAND, WASHTENAW, WAYNE, ALCONA, ALGER, ALLEGAN, ALPENA, ANTRIM, ARENAC, BARAGA, BARRY, BAY, BENZIE, BERRIEN, BRANCH, CALHOUN, CASS, CHARLEVOIX, CHEBOYGAN, CHIPPEWA, CLARE, CLINTON, CRAWFORD, DELTA, DICKINSON, EATON, EMMET, GLADWIN, GOGEBIC, GRAND TRAVERSE, GRATIOT, HILLSDALE, HOUGHTON, HURON, INGHAM, IONIA, IOSCO, IRON, ISABELLA, JACKSON, KALAMAZOO, KALKASKA, KENT, KEWEENAW, LAKE, LAPEER, LEELANAU, LENAWEE, LIVINGSTON, LUCE, MACKINAC, MANISTEE, MARQUETTE, MASON, MECOSTA, MENOMINEE, MIDLAND, MISSAUKEE, MONTCALM, MONTMORENCY, MUSKEGON, NEWAYGO, OCEANA, OGEMAW, ONTONAGON, OSCEOLA, OSCODA, OTSEGO, OTTAWA, PRESQUE ISLE, ROSCOMMON, SAGINAW, ST. CLARE, ST. JOSEPH, SANILAC, SCHOOLCRAFT, SHIAWASSEE, TUSCOLA, VAN BUREN AND WEXFORD COUNTIES

	Rates	Fringes
Power equipment operators: (AIRPORT, BRIDGE & HIGHWAY CONSTRUCTION)		
GROUP 1.....	\$ 43.71	25.25
GROUP 2.....	\$ 42.56	25.25
GROUP 3.....	\$ 35.83	25.25
GROUP 4.....	\$ 35.27	25.25

POWER EQUIPMENT OPERATOR CLASSIFICATIONS

GROUP 1: Paver Operator (5 bags or more); Slip Form Paver; Asphalt Paver (self propelled); Shovel (Excavator) installing utilities over 20 feet in depth.

Group 2: Asphalt plant operator; crane operator (does not include work on bridge construction projects when the crane operator is erecting structural components); Dragline operator; Shovel (Excavator) operator; Locomotive operator; Elevating grader operator; Pile driving operator; Roller operator (asphalt); Blade grader operator; Trenching machine operator (ladder or wheel type); Auto-grader; Self-propelled or tractor-drawn scraper; Conveyor loader operator (Euclid type); Bulldozer; Hoisting engineer; Tractor operator; Finishing machine operator (asphalt); Mechanic; Pump operator (6-in. discharge or over, gas, diesel powered or generator of 300 amp. or larger); Shouldering or gravel distributing machine operator (self-propelled); Backhoe (with over 3/8 yd. bucket); Side boom tractor (type D-4 or equivalent or larger); Tube finisher (slip form paving); Gradall (and similar type machine); Asphalt planner (self-propelled); Batch plant (concrete-central mix); Slurry machine (asphalt); Concrete pump (3 in. and over); Roto-mill; Swinging boom truck (over 12 ton capacity); Hydro demolisher (water blaster); Farm-type tractor with attached pan; Vacuum truck operator; Batch Plant (concrete dry batch); Concrete Saw Operator (40h.p. or over; Tractor Operator (farm type); Finishing Machine Operator (concrete); Grader Operator (self-propelled fine grade or form (concrete); tractor operator (farm type with attachment); Wagon Drill operator; Boom or winch hoist truck operator.

GROUP 3: Screening plant operator; Washing plant operator; Crusher operator; Backhoe (with 3/8 yd. bucket or less); Side boom tractor (smaller than D-4 type or equivalent); Sweeper (Wayne type and similar equipment); Greese Truck; Air Compressor Operator (600 cu.ft. per min or more); Air

Compressor Operator (two or more, less than 600 cfm); End Loader operator (1 yard Capacity and over); Side boom tractor (type D or equivalent or larger; Endloader operator *under 1 yard capacity; Trencher (service).

GROUP 4: Boiler fire tender; Concrete Breaker; Oiler; Fire tender; Trencher (service); Flexplane operator; Cleftplane operator; Roller operator (other than asphalt); Curing equipment operator (self-propelled); Power bin operator; Plant drier operator (asphalt); Vibratory compaction equipment operator (6 ft. wide or over); Guard post driver operator (power driven); All mulching equipment; Stump remover; Concrete pump (under 3-in.); Mesh installer (self-propelled); End dump; Skid steer.

 ENGI0324-007 05/01/2024

ALGER, BARAGA, CHIPPEWA, DELTA, DICKINSON, GOGEBIC, HOUGHTON, IRON, KEWEENAW, LUCE, MACKINAC MARQUETTE, MENOMINEE, ONTONAGON AND SCHOOLCRAFT COUNTIES:

	Rates	Fringes
OPERATOR: Power Equipment		
(Steel Erection)		
Compressor, welder and forklift.....	\$ 40.90	25.00
Crane operator, main boom & jib 120' or longer.....	\$ 47.37	25.00
Crane operator, main boom & jib 140' or longer.....	\$ 47.37	24.60
Crane operator, main boom & jib 220' or longer.....	\$ 48.26	25.00
Mechanic with truck and tools.....	\$ 46.50	25.00
Oiler and fireman.....	\$ 39.96	25.00
Regular operator.....	\$ 44.72	25.00

 ENGI0324-008 10/01/2023

ALCONA, ALGER, ALLEGAN, ALPENA, ANTRIM, ARENAC, BARAGA, BARRY, BAY, BENZIE, BERRIEN, BRANCH, CALHOUN, CASS, CHARLEVOIX, CHEBOYGAN, CHIPPEWA, CLARE, CLINTON, CRAWFORD, DELTA, DICKINSON, EATON, EMMET, GENESEE, GLADWIN, GOGEBIC, GRAND TRAVERSE, GRATIOT, HILLSDALE, HOUGHTON, HURON, INGHAM, IONIA, IOSCO, IRON, ISABELLA, JACKSON, KALAMAZOO, KALKASKA, KENT, KEWEENAW, LAKE, LAPEER, LEELANAU, LENAWEE, LIVINGSTON, LUCE, MACKINAC, MACOMB, MANISTEE, MARQUETTE, MASON, MECOSTA,

MENOMINEE, MIDLAND, MISSAUKEE, MONTCALM, MONTMORENCY, MONROE, MUSKEGON, NEWAYGO, OAKLAND, OCEANA, OGEMAW, ONTONAGON, OSCEOLA, OSCODA, OTSEGO, OTTAWA, PRESQUE ISLE, ROSCOMMON, SAGINAW, ST. CLARE, ST. JOSEPH, SANILAC, SCHOOLCRAFT, SHIAWASSEE, TUSCOLA, VAN BUREN, WASHTENAW, WAYNE AND WEXFORD COUNTIES

	Rates	Fringes
OPERATOR: Power Equipment (Sewer Relining)		
GROUP 1.....	\$ 37.37	15.44
GROUP 2.....	\$ 35.33	15.44

SEWER RELINING CLASSIFICATIONS

GROUP 1: Operation of audio-visual closed circuit TV system, including remote in-ground cutter and other equipment used in connection with the CCTV system

GROUP 2: Operation of hot water heaters and circulation systems, water jetters and vacuum and mechanical debris removal systems

ENGI0325-012 05/01/2024

	Rates	Fringes
Power equipment operators - gas distribution and duct installation work:		
GROUP 1.....	\$ 37.98	25.25
GROUP 2.....	\$ 34.75	25.25

SCOPE OF WORK: The construction, installation, treating and reconditioning of pipelines transporting gas vapors within cities, towns, subdivisions, suburban areas, or within private property boundaries, up to and including private meter settings of private industrial, governmental or other premises, more commonly referred to as ""distribution work,"" starting from the first metering station, connection, similar or related facility, of the main or cross country pipeline and including duct installation.

Group 1: Backhoe, crane, grader, mechanic, dozer (D-6 equivalent or larger), side boom (D-4 equivalent or larger), trencher(except service), endloader (2 yd. capacity or greater).

GROUP 2: Dozer (less than D-6 equivalent), endloader (under 2 yd. capacity), side boom (under D-4 capacity), backfiller, pumps (1 or 2 of 6-inch discharge or greater), boom truck (with powered boom), tractor (wheel type other than backhoe or front endloader). Tamper (self-propelled), boom truck (with non-powered boom), concrete saw (20 hp or larger), pumps (2 to 4 under 6-inch discharge), compressor (2 or more or when one is used continuously into the second day) and trencher(service). Oiler, hydraulic pipe pushing machine, grease person and hydrostatic testing operator.

 IRON0008-007 06/01/2024

ALGER, BARAGA, CHIPPEWA, DELTA, DICKINSON, GOGEBIC, HOUGHTON, IRON, KEWEENAW, LUCE, MACKINAC MARQUETTE, MENOMINEE, ONTONAGON AND SCHOOLCRAFT COUNTIES:

	Rates	Fringes
Ironworker - pre-engineered metal building erector.....	\$ 23.70	6.95
IRONWORKER		
General contracts \$10,000,000 or greater.....	\$ 39.91	32.32
General contracts less than \$10,000,000.....	\$ 39.91	32.32

Paid Holidays: New Year's Day, Memorial Day, July 4th, Labor Day, Thanksgiving Day & Christmas Day.

 IRON0025-002 06/01/2024

ALCONA, ALPENA, ARENAC, BAY, CHEBOYGAN, CLARE, CLINTON, CRAWFORD, GENESEE, GLADWIN, GRATIOT, HURON, INGHAM, IOSCO, ISABELLA, JACKSON, LAPEER, LIVINGSTON, MACOMB, MIDLAND, MONTMORENCY, OAKLAND, OGEMAW, OSCODA, OTSEGO, PRESQUE ISLE, ROSCOMMON, SAGINAW, SANILAC, SHIAWASSEE, ST. CLAIR, TUSCOLA, WASHTENAW AND WAYNE COUNTIES:

	Rates	Fringes
Ironworker - pre-engineered metal building erector		
ALLEGAN, ANTRIM, BARRY, BENZIE, BRANCH, CALHOUN, CHARLEVOIX, EATON, EMMET,		

GRAND TRAVERSE, HILLSDALE, IONIA, KALAMAZOO, KALKASKA, KENT, LAKE, LEELANAU, MANISTEE, MASON, MECOSTA, MISSAUKEE, MONTCALM, MUSKEGON, NEWAYGO, OCEANA, OSCEOLA, OTTAWA, ST. JOSEPH, VAN BUREN AND WEXFORD COUNTIES:..\$ 35.55	33.14
Bay, Genesee, Lapeer, Livingston (east of Burkhardt Road), Macomb, Midland, Oakland, Saginaw, St. Clair, The University of Michigan, Washtenaw (east of U.S. 23) & Wayne...\$ 25.81	26.43
IRONWORKER Ornamental and Structural...\$ 34.50	38.44
Reinforcing.....\$ 33.43	37.15

IRON0055-005 07/01/2022

LENAWEE AND MONROE COUNTIES:

	Rates	Fringes
IRONWORKER Pre-engineered metal buildings.....\$ 23.59		19.35
All other work.....\$ 33.00		27.20

IRON0292-003 06/01/2020

BERRIEN AND CASS COUNTIES:

	Rates	Fringes
IRONWORKER (Including pre-engineered metal building erector).....\$ 31.75		22.84

* LAB00005-006 10/01/2022

	Rates	Fringes
Laborers - hazardous waste abatement: (ALCONA, ALPENA, ANTRIM, BENZIE, CHARLEVOIX, CHEBOYGAN, CRAWFORD, EMMET, GRAND TRAVERSE, IOSCO,		

KALKASKA, LEELANAU,
 MISSAUKEE, MONTMORENCY,
 OSCODA, OTSEGO, PRESQUE ISLE
 AND WEXFORD COUNTIES - Zone
 10)

Levels A, B or C.....	\$ 17.45	12.75
class b.....	\$ 18.64	12.90
Work performed in conjunction with site preparation not requiring the use of personal protective equipment;		
Also, Level D.....	\$ 16.45 **	12.75
class a.....	\$ 17.64	12.90

Zone 10

Laborers - hazardous waste
 abatement: (ALGER, BARAGA,
 CHIPPEWA, DELTA, DICKINSON,
 GOGEBIC, HOUGHTON, IRON,
 KEWEENAW, LUCE, MACKINAC,
 MARQUETTE, MENOMINEE,
 ONTONAGON AND SCHOOLCRAFT
 COUNTIES - Zone 11)

Levels A, B or C.....	\$ 25.18	12.90
Work performed in conjunction with site preparation not requiring the use of personal protective equipment;		
Also, Level D.....	\$ 22.58	12.90

Laborers - hazardous waste
 abatement: (ALLEGAN, BARRY,
 BERRIEN, BRANCH, CALHOUN,
 CASS, IONIA COUNTY (except
 the city of Portland);
 KALAMAZOO, KENT, LAKE,
 MANISTEE, MASON, MECOSTA,
 MONTCALM, MUSKEGON, NEWAYGO,
 OCEANA, OSCEOLA, OTTAWA, ST.
 JOSEPH AND VAN BUREN COUNTIES
 - Zone 9)

Levels A, B or C.....	\$ 21.88	13.26
Work performed in conjunction with site preparation not requiring the use of personal protective equipment;		
Also, Level D.....	\$ 20.80	12.90

Laborers - hazardous waste
 abatement: (ARENAC, BAY,

CLARE, GLADWIN, GRATIOT, HURON, ISABELLA, MIDLAND, OGEMAW, ROSCOMMON, SAGINAW AND TUSCOLA COUNTIES - Zone 8)		
Levels A, B or C.....\$ 23.74		12.95
Work performed in conjunction with site preparation not requiring the use of personal protective equipment;		
Also, Level D.....\$ 20.80		12.90
Laborers - hazardous waste abatement: (CLINTON, EATON AND INGHAM COUNTIES; IONIA COUNTY (City of Portland); LIVINGSTON COUNTY (west of Oak Grove Rd., including the City of Howell) - Zone 6)		
Levels A, B or C.....\$ 26.33		12.95
Work performed in conjunction with site preparation not requiring the use of personal protective equipment;		
Also, Level D.....\$ 24.64		12.90
Laborers - hazardous waste abatement: (GENESEE, LAPEER AND SHIAWASSEE COUNTIES - Zone 7)		
Levels A, B or C.....\$ 24.20		13.80
Work performed in conjunction with site preparation not requiring the use of personal protective equipment;		
Also, Level D.....\$ 23.20		13.80
Laborers - hazardous waste abatement: (HILLSDALE, JACKSON AND LENAWEЕ COUNTIES - Zone 4)		
Levels A, B or C.....\$ 27.13		14.95
Work performed in conjunction with site preparation not requiring the use of personal protective equipment;		
Also, Level D.....\$ 24.17		12.90
Laborers - hazardous waste abatement: (LIVINGSTON COUNTY (east of Oak Grove Rd. and		

south of M-59, excluding the city of Howell); AND
WASHTENAW COUNTY - Zone 3)
Levels A, B or C.....\$ 29.93 14.20
Work performed in conjunction with site preparation not requiring the use of personal protective equipment;
Also, Level D.....\$ 28.93 14.20
Laborers - hazardous waste abatement: (MACOMB AND WAYNE COUNTIES - Zone 1)
Levels A, B or C.....\$ 29.93 16.90
Work performed in conjunction with site preparation not requiring the use of personal protective equipment;
Also, Level D.....\$ 28.93 16.90
Laborers - hazardous waste abatement: (MONROE COUNTY - Zone 4)
Levels A, B or C.....\$ 31.75 14.90
Work performed in conjunction with site preparation not requiring the use of personal protective equipment;
Also, Level D.....\$ 31.75 14.90
Laborers - hazardous waste abatement: (OAKLAND COUNTY and the Northeast portion of LIVINGSTON COUNTY bordered by Oak Grove Road on the West and M-59 on the South - Zone 2)
Level A, B, C.....\$ 29.93 16.90
Work performed in conjunction with site preparation not requiring the use of personal protective equipment;
Also, Level D.....\$ 28.93 16.90
Laborers - hazardous waste abatement: (SANILAC AND ST. CLAIR COUNTIES - Zone 5)
Levels A, B or C.....\$ 26.21 16.62
Work performed in conjunction with site

preparation not requiring
the use of personal
protective equipment;

Also, Level D.....\$ 24.75 16.35

LAB00259-001 09/01/2024

AREA 1: MACOMB, OAKLAND AND WAYNE COUNTIES
AREA 2: ALCONA, ALGER, ALLEGAN, ALPENA, ANTRIM, ARENAC, BARAGA,
BARRY, BAY, BENZIE, BERRIEN, BRANCH, CALHOUN, CASS, CHARLEVOIX,
CHEBOYGAN, CHIPPEWA, CLARE, CLINTON, CRAWFORD, DELTA,
DICKINSON, EATON, EMMET, GENESEE, GLADWIN, GOGEBIC, GRAND
TRAVERSE, GRATIOT, HILLSDALE, HOUGHTON, HURON, INGHAM, IONIA,
IOSCO, IRON, ISABELLA, JACKSON, KALAMAZOO, KALKASKA, KENT,
KEWEENAW, LAKE, LAPEER, LEELANAU, LENAWEE, LIVINGSTON, LUCE,
MACKINAC, MANISTEE, MARQUETTE, MASON, MECOSTA, MENOMINEE,
MIDLAND, MISSAUKEE, MONROE, MONTCALM, MONTMORENCY, MUSKEGON,
NEWAYGO, OCEANA, OGEMAW, ONTONAGON, OSCEOLA, OSCODA, OTSEGO,
OTTAWA, PRESQUE ISLE, ROSCOMMON, SAGINAW, ST. CLARE, ST.
JOSEPH, SANILAC, SCHOOLCRAFT, SHIAWASSEE, TUSCOLA, VAN BUREN,
WASHTENAW AND WEXFORD COUNTIES

	Rates	Fringes
Laborers - tunnel, shaft and caisson:		
AREA 1		
GROUP 1.....	\$ 27.86	22.11
GROUP 2.....	\$ 29.86	22.11
GROUP 3.....	\$ 25.86	22.11
GROUP 4.....	\$ 23.97	16.93
GROUP 5.....	\$ 24.22	16.93
GROUP 6.....	\$ 24.55	16.93
GROUP 7.....	\$ 17.83	16.93
AREA 2		
GROUP 1.....	\$ 30.00	17.45
GROUP 2.....	\$ 32.00	17.45
GROUP 3.....	\$ 28.00	17.45
GROUP 4.....	\$ 29.57	16.93
GROUP 5.....	\$ 25.76	16.93
GROUP 6.....	\$ 26.07	16.93
GROUP 7.....	\$ 25.57	16.93

SCOPE OF WORK: Tunnel, shaft and caisson work of every type
and description and all operations incidental thereto,
including, but not limited to, shafts and tunnels for
sewers, water, subways, transportation, diversion,
sewerage, caverns, shelters, aquifers, reservoirs, missile
silos and steel sheeting for underground construction.

TUNNEL LABORER CLASSIFICATIONS

GROUP 1: Tunnel, shaft and caisson laborer, dump, shanty, hog house tender, testing (on gas) and watchman

GROUP 2: Manhole, headwall, catch basin builder, bricklayer tender, mortar machine and material mixer

GROUP 3: Air tool operator (jackhammer, bush hammer and grinder), first bottom, second bottom, cage tender, car pusher, carrier, concrete, concrete form, concrete repair, cement invert laborer, cement finisher, concrete shoveler, conveyor, floor, gasoline and electric tool operator, gunite, grout operator, welder, heading dinky person, inside lock tender, pea gravel operator, pump, outside lock tender, scaffold, top signal person, switch person, track, tugger, utility person, vibrator, winch operator, pipe jacking, wagon drill and air track operator and concrete saw operator (under 40 h.p.)

GROUP 4: Tunnel, shaft and caisson mucker, bracer, liner plate, long haul dinky driver and well point

GROUP 5: Tunnel, shaft and caisson miner, drill runner, key board operator, power knife operator, reinforced steel or mesh (e.g. wire mesh, steel mats, dowel bars, etc.)

GROUP 6: Dynamite and powder

GROUP 7: Restoration laborer, seeding, sodding, planting, cutting, mulching and top soil grading; and the restoration of property such as replacing mailboxes, wood chips, planter boxes, flagstones, etc.

LAB00334-001 09/01/2024

	Rates	Fringes
Laborers - open cut:		
ZONE 1 - MACOMB, OAKLAND		
AND WAYNE COUNTIES:		
GROUP 1.....	\$ 27.71	22.11
GROUP 2.....	\$ 29.71	22.11
GROUP 3.....	\$ 25.87	22.11
GROUP 4.....	\$ 23.71	16.72
GROUP 5.....	\$ 24.17	16.72
GROUP 6.....	\$ 22.00	16.72
GROUP 7.....	\$ 17.84	16.72

ZONE 2 - LIVINGSTON COUNTY
 (east of M-151 (Oak Grove
 Rd.)); MONROE AND
 WASHTENAW COUNTIES:

GROUP 1.....	\$ 29.65	17.45
GROUP 2.....	\$ 31.65	17.45
GROUP 3.....	\$ 27.65	17.45
GROUP 4.....	\$ 25.10	16.72
GROUP 5.....	\$ 25.25	16.72
GROUP 6.....	\$ 22.55	16.72
GROUP 7.....	\$ 22.11	16.72

ZONE 3 - CLINTON, EATON,
 GENESEE, HILLSDALE AND
 INGHAM COUNTIES; IONIA
 COUNTY (City of Portland);
 JACKSON, LAPEER AND
 LENAWEE COUNTIES;
 LIVINGSTON COUNTY (west of
 M-151 Oak Grove Rd.);
 SANILAC, ST. CLAIR AND
 SHIAWASSEE COUNTIES:

GROUP 1.....	\$ 27.84	17.45
GROUP 2.....	\$ 29.84	17.45
GROUP 3.....	\$ 25.84	17.45
GROUP 4.....	\$ 23.30	16.72
GROUP 5.....	\$ 23.44	16.72
GROUP 6.....	\$ 20.74	16.72
GROUP 7.....	\$ 22.23	16.72

ZONE 4 - ALCONA, ALLEGAN,
 ALPENA, ANTRIM, ARENAC,
 BARRY, BAY, BENZIE,
 BERRIEN, BRANCH,
 CALHOUN, CASS, CHARLEVOIX,
 CHEBOYGAN, CLARE,
 CRAWFORD, EMMET,
 GLADWIN, GRAND TRAVERSE,
 GRATIOT AND HURON
 COUNTIES; IONIA COUNTY
 (EXCEPT THE CITY OF
 PORTLAND); IOSCO,
 ISABELLA, KALAMAZOO,
 KALKASKA, KENT,
 LAKE, LEELANAU, MANISTEE,
 MASON, MECOSTA, MIDLAND,
 MISSAUKEE, MONTCALM,
 MONTMORENCY, MUSKEGON,
 NEWAYGO, OCEANA, OGEMAW,
 OSCEOLA, OSCODA, OTSEGO,
 OTTAWA, PRESQUE ISLE,
 ROSCOMMON, SAGINAW, ST.

JOSEPH, TUSCOLA, VAN BUREN
AND WEXFORD COUNTIES:

GROUP 1.....	\$ 26.32	17.95
GROUP 2.....	\$ 28.32	17.95
GROUP 3.....	\$ 24.32	17.95
GROUP 4.....	\$ 22.33	16.72
GROUP 5.....	\$ 22.45	16.72
GROUP 6.....	\$ 19.67	16.72
GROUP 7.....	\$ 22.30	16.72

ZONE 5 - ALGER, BARAGA,
CHIPPEWA, DELTA,
DICKINSON, GOGEBIC,
HOUGHTON, IRON,
KEWEENAW, LUCE, MACKINAC,
MARQUETTE, MENOMINEE,
ONTONAGON AND SCHOOLCRAFT
COUNTIES:

GROUP 1.....	\$ 26.09	18.45
GROUP 2.....	\$ 28.09	18.45
GROUP 3.....	\$ 24.09	18.45
GROUP 4.....	\$ 22.56	16.72
GROUP 5.....	\$ 22.64	16.72
GROUP 6.....	\$ 19.99	16.72
GROUP 7.....	\$ 22.45	16.72

SCOPE OF WORK:

Open cut construction work shall be construed to mean work which requires the excavation of earth including industrial, commercial and residential building site excavation and preparation, land balancing, demolition and removal of concrete and underground appurtenances, grading, paving, sewers, utilities and improvements; retention, oxidation, flocculation and irrigation facilities, and also including but not limited to underground piping, conduits, steel sheeting for underground construction, and all work incidental thereto, and general excavation. For all areas except the Upper Peninsula, open cut construction work shall also be construed to mean waterfront work, piers, docks, seawalls, breakwalls, marinas and all incidental work. Open cut construction work shall not include any structural modifications, alterations, additions and repairs to buildings, or highway work, including roads, streets, bridge construction and parking lots or steel erection work and excavation for the building itself and back filling inside of and within 5 ft. of the building and foundations, footings and piers for the building. Open cut construction work shall not include any work covered under Tunnel, Shaft and Caisson work.

OPEN CUT LABORER CLASSIFICATIONS

GROUP 1: Construction laborer

GROUP 2: Mortar and material mixer, concrete form person, signal person, well point person, manhole, headwall and catch basin builder, headwall, seawall, breakwall and dock builder

GROUP 3: Air, gasoline and electric tool operator, vibrator operator, driller, pump person, tar kettle operator, bracer, rodder, reinforced steel or mesh person (e.g., wire mesh, steel mats, dowel bars, etc.), welder, pipe jacking and boring person, wagon drill and air track operator and concrete saw operator (under 40 h.p.), windlass and tugger person and directional boring person

GROUP 4: Trench or excavating grade person

GROUP 5: Pipe layer (including crock, metal pipe, multi-plate or other conduits)

GROUP 6: Grouting man, audio-visual television operations and all other operations in connection with closed circuit television inspection, pipe cleaning and pipe relining work and the installation and repair of water service pipe and appurtenances

GROUP 7: Restoration laborer, seeding, sodding, planting, cutting, mulching and top soil grading; and the restoration of property such as replacing mailboxes, wood chips, planter boxes, flagstones, etc.

LAB00465-001 06/01/2024

LABORER: Highway, Bridge and Airport Construction

AREA 1: GENESEE, MACOMB, MONROE, OAKLAND, WASHTENAW AND WAYNE COUNTIES

AREA 2: ALLEGAN, BARRY, BAY, BERRIEN, BRANCH, CALHOUN, CASS, CLINTON, EATON, GRATIOT, HILLSDALE, HURON, INGHAM, JACKSON, KALAMAZOO, LAPEER, LENAWE, LIVINGSTON, MIDLAND, MUSKEGON, SAGINAW, SANILAC, SHIAWASSEE, ST. CLAIR, ST. JOSEPH, TUSCOLA AND VAN BUREN COUNTIES

AREA 3: ALCONA, ALPENA, ANTRIM, ARENAC, BENZIE, CHARLEVOIX, CHEBOYGAN, CLARE, CRAWFORD, EMMET, GLADWIN, GRAND TRAVERSE, IONIA, IOSCO, ISABELLA, KALKASKA, KENT, LAKE, LEELANAU,

MANISTEE, MASON, MECOSTA, MISSAUKEE, MONTCALM, MONTMORENCY,
 NEWAYGO, OCEANA, OGEMAW, OSCEOLA, OSCODA, OTSEGO, OTTAWA,
 PRESQUE ISLE, ROSCOMMON AND WEXFORD COUNTIES

AREA 4: ALGER, BARAGA, CHIPPEWA, DELTA, DICKINSON, GOGEBIC,
 HOUGHTON, IRON, KEWEENAW, LUCE, MACKINAC, MARQUETTE, MENOMINEE,
 ONTONAGON AND SCHOOLCRAFT COUNTIES

	Rates	Fringes
LABORER (AREA 1)		
GROUP 1.....	\$ 34.01	14.45
GROUP 2.....	\$ 34.14	14.45
GROUP 3.....	\$ 34.32	14.45
GROUP 4.....	\$ 34.40	14.45
GROUP 5.....	\$ 34.61	14.45
GROUP 6.....	\$ 34.91	14.45
LABORER (AREA 2)		
GROUP 1.....	\$ 31.87	14.45
GROUP 2.....	\$ 32.07	14.45
GROUP 3.....	\$ 32.31	14.45
GROUP 4.....	\$ 32.66	14.45
GROUP 5.....	\$ 32.53	14.45
GROUP 6.....	\$ 32.87	14.45
LABORER (AREA 3)		
GROUP 1.....	\$ 31.12	14.45
GROUP 2.....	\$ 31.33	14.45
GROUP 3.....	\$ 31.62	14.45
GROUP 4.....	\$ 32.06	14.45
GROUP 5.....	\$ 31.68	14.45
GROUP 6.....	\$ 32.11	14.45
LABORER (AREA 4)		
GROUP 1.....	\$ 32.02	14.45
GROUP 2.....	\$ 31.73	14.45
GROUP 3.....	\$ 32.52	14.45
GROUP 4.....	\$ 32.96	14.45
GROUP 5.....	\$ 32.58	14.45
GROUP 6.....	\$ 33.01	14.45

LABORER CLASSIFICATIONS

GROUP 1: Asphalt shoveler or loader; asphalt plant misc.;
 burlap person; yard person; dumper (wagon, truck, etc.);
 joint filling laborer; miscellaneous laborer; unskilled
 laborer; sprinkler laborer; form setting laborer; form
 stripper; pavement reinforcing; handling and placing (e.g.,
 wire mesh, steel mats, dowel bars); mason's tender or
 bricklayer's tender on manholes; manhole builder;
 headwalls, etc.; waterproofing,(other than buildings) seal

coating and slurry mix, shoring, underpinning; pressure grouting; bridge pin and hanger removal; material recycling laborer; horizontal paver laborer (brick, concrete, clay, stone and asphalt); ground stabilization and modification laborer; grouting; waterblasting; top person; railroad track and trestle laborer; carpenters' tender; guard rail builders' tender; earth retention barrier and wall and M.S.E. wall installer's tender; highway and median installer's tender(including sound, retaining, and crash barriers); fence erector's tender; asphalt raker tender; sign installer; remote control operated equipment.

GROUP 2: Mixer operator (less than 5 sacks); air or electric tool operator (jackhammer, etc.); spreader; boxperson (asphalt, stone, gravel); concrete paddler; power chain saw operator; paving batch truck dumper; tunnel mucker (highway work only); concrete saw (under 40 h.p.) and dry pack machine; roto-mill grounds person.

GROUP 3: Tunnel miner (highway work only); finishers tenders; guard rail builders; highway and median barrier installer; earth retention barrier and wall and M.S.E. wall installer's (including sound, retaining and crash barriers); fence erector; bottom person; powder person; wagon drill and air track operator; diamond and core drills; grade checker; certified welders; curb and side rail setter's tender.

GROUP 4: Asphalt raker

GROUP 5: Pipe layers, oxy-gun

GROUP 6: Line-form setter for curb or pavement; asphalt screed checker/screw man on asphalt paving machines.

LAB01076-005 04/01/2024

MICHIGAN STATEWIDE

	Rates	Fringes
LABORER (DISTRIBUTION WORK)		
Zone 1.....	\$ 27.16	13.45
Zone 2.....	\$ 25.42	13.45
Zone 3.....	\$ 23.55	13.45
Zone 4.....	\$ 22.92	13.45
Zone 5.....	\$ 22.95	13.45

DISTRIBUTION WORK - The construction, installation, treating

and reconditioning of distribution pipelines transporting coal, oil, gas or other similar materials, vapors or liquids, including pipelines within private property boundaries, up to and including the meter settings on residential, commercial, industrial, institutional, private and public structures. All work covering pumping stations and tank farms not covered by the Building Trades Agreement. Other distribution lines with the exception of sewer, water and cable television are included.

Underground Duct Layer Pay: \$.40 per hour above the base pay rate.

- Zone 1 - Macomb, Oakland and Wayne
- Zone 2 - Monroe and Washtenaw
- Zone 3 - Bay, Genesee, Lapeer, Midland, Saginaw, Sanilac, Shiawassee and St. Clair
- Zone 4 - Alger, Baraga, Chippewa, Delta, Dickinson, Gogebic, Houghton, Iron, Keweenaw, Luce, Mackinac, Marquette, Menominee, Ontonagon and Schoolcraft
- Zone 5 - Remaining Counties in Michigan

 PAIN0022-002 07/01/2008

HILLSDALE, JACKSON AND LENAWEE COUNTIES; LIVINGSTON COUNTY (east of the eastern city limits of Howell, not including the city of Howell, north to the Genesee County line and south to the Washtenaw County line); MACOMB, MONROE, OAKLAND, WASHTENAW AND WAYNE COUNTIES:

	Rates	Fringes
PAINTER.....	\$ 25.06	14.75

FOOTNOTES: For all spray work and journeyman rigging for spray work, also blowing off, \$.80 per hour additional (applies only to workers doing rigging for spray work on off the floor work. Does not include setting up or moving rigging on floor surfaces, nor does it apply to workers engaged in covering up or tending spray equipment. For all sandblasting and spray work performed on highway bridges, overpasses, tanks or steel, \$.80 per hour additional. For all brushing, cleaning and other preparatory work (other than spraying or steeplejack work) at scaffold heights of fifty (50) feet from the ground or higher, \$.50 per hour additional. For all preparatorial work and painting performed on open steel under forty (40) feet when no scaffolding is involved, \$.50 per hour additional. For all

swing stage work-window jacks and window belts-exterior and interior, \$0.50 per hour additional. For all spray work and sandblaster work to a scaffold height of forty (40) feet above the floor level, \$0.80 per hour additional. For all preparatorial work and painting on all highway bridges or overpasses up to forty (40) feet in height, \$0.50 per hour additional. For all steeplejack work performed where the elevation is forty (40) feet or more, \$1.25 per hour additional.

 PAIN0312-001 06/01/2018

EXCLUDES: ALLEGAN COUNTY (Townships of Dorr, Fillmore, Heath, Hopkins, Laketown, Leighton, Manlius, Monterey, Overisel, Salem, Saugatuck and Wayland); INCLUDES: Barry, Berrien, Branch, Calhoun, Cass, Hillsdale, Kalamazoo, St. Joseph, Van Buren

	Rates	Fringes
PAINTER		
Brush and roller.....	\$ 23.74	13.35
Spray, Sandblast, Sign		
Painting.....	\$ 24.94	13.35

 PAIN0845-003 05/10/2018

CLINTON COUNTY; EATON COUNTY (does not include the townships of Bellevue and Olivet); INGHAM COUNTY; IONIA COUNTY (east of Hwy. M 66); LIVINGSTON COUNTY (west of the eastern city limits of Howell, including the city of Howell, north to the Genesee County line and south to the Washtenaw County line); AND SHIAWASSEE COUNTY (Townships of Bennington, Laingsbury and Perry):

	Rates	Fringes
PAINTER.....	\$ 25.49	13.74

 PAIN0845-015 05/10/2018

MUSKEGON COUNTY; NEWAYGO COUNTY (except the Townships of Barton, Big Prairie, Brooks, Croton, Ensley, Everett, Goodwell, Grant, Home, Monroe, Norwich and Wilcox); OCEANA COUNTY; OTTAWA COUNTY (except the townships of Allendale, Blendone, Chester, Georgetown, Holland, Jamestown, Olive, Park, Polkton, Port Sheldon, Tallmadge, Wright and Zeeland):

	Rates	Fringes
PAINTER.....	\$ 25.49	13.74

PAIN0845-018 05/10/2018		

ALLEGAN COUNTY (Townships of Dorr, Fillmore, Heath, Hopkins, Laketown, Leighton, Manlius, Monterey, Overisel, Salem, Saugatuck and Wayland); IONIA COUNTY (west of Hwy. M-66); KENT, MECOSTA AND MONTCALM COUNTIES; NEWAYGO COUNTY (Townships of Barton, Big Prairie, Brooks, Croton, Ensley, Everett, Goodwell, Grant, Home, Monroe, Norwich and Wilcox); OSCEOLA COUNTY (south of Hwy. #10); OTTAWA COUNTY (Townships of Allendale, Blendone, Chester, Georgetown, Holland, Jamestown, Olive, Park, Polkton, Port Sheldon, Tallmadge, Wright and Zeeland):

	Rates	Fringes
PAINTER.....	\$ 25.49	13.74

FOOTNOTES: Lead abatement work: \$1.00 per hour additional.		

PAIN1011-003 06/02/2022

ALGER, BARAGA, CHIPPEWA, DELTA, DICKINSON, GOGEBIC, HOUGHTON, IRON, KEWEENAW, LUCE, MACKINAC, MARQUETTE, MENOMINEE, ONTONAGON AND SCHOOLCRAFT COUNTIES:

	Rates	Fringes
PAINTER.....	\$ 24.66	14.99

FOOTNOTES: High pay (bridges, overpasses, watertower): 30 to 80 ft.: \$.65 per hour additional. 80 ft. and over: \$1.30 per hour additional.		

PAIN1474-002 06/01/2010

HURON COUNTY; LAPEER COUNTY (east of Hwy. M-53); ST. CLAIR, SANILAC AND TUSCOLA COUNTIES:

	Rates	Fringes
PAINTER.....	\$ 23.79	12.02

FOOTNOTES: Lead abatement work: \$1.00 per hour additional. Work with any hazardous material: \$1.00 per hour additional. Sandblasting, steam cleaning and acid cleaning: \$1.00 per hour additional. Ladder work at or above 40 ft., scaffold work at or above 40 ft., swing stage, boatswain chair, window jacks and all work performed over a falling height of 40 ft.: \$1.00 per hour additional. Spray gun work, pick pullers and those handling needles, blowing off by air pressure, and any person rigging (setting up and moving off the ground): \$1.00 per hour additional. Steeplejack, tanks, gas holders, stacks, flag poles, radio towers and beacons, power line towers, bridges, etc.: \$1.00 per hour additional, paid from the ground up.

 PAIN1803-003 06/01/2024

ALCONA, ALPENA, ANTRIM, ARENAC, BAY, BENZIE, CHARLEVOIX, CHEBOYGAN, CLARE, CRAWFORD, EMMET, GLADWIN, GRAND TRAVERSE, GRATIOT, IOSCO, ISABELLA, KALKASKA, LAKE, LEELANAU, MANISTEE, MASON, MIDLAND, MISSAUKEE, MONTMORENCY AND OGEMAW COUNTIES; OSCEOLA COUNTY (north of Hwy. #10); OSCODA, OTSEGO, PRESQUE ISLE, ROSCOMMON, SAGINAW AND WEXFORD COUNTIES:

	Rates	Fringes
PAINTER		
Work performed on water, bridges over water or moving traffic, radio and powerline towers, elevated tanks, steeples, smoke stacks over 40 ft. of falling heights, recovery of lead-based paints and any work associated with industrial plants, except maintenance of industrial plants.....	\$ 29.35	19.05
All other work, including maintenance of industrial plant.....	\$ 29.35	19.05

FOOTNOTES: Spray painting, sandblasting, blowdown associated with spraying and blasting, water blasting and work involving a swing stage, boatswain chair or spider: \$1.00 per hour additional. All work performed inside tanks, vessels, tank trailers, railroad cars, sewers, smoke

stacks, boilers or other spaces having limited egress not including buildings, opentop tanks, pits, etc.: \$1.25 per hour additional.

 PLAS0514-001 06/01/2023

ZONE 1: GENESEE, LIVINGSTON, MACOMB, MONROE, OAKLAND, SAGINAW, WASHTENAW AND WAYNE COUNTIES

ZONE 2: ALCONA, ALGER, ALLEGAN, ALPENA, ANTRIM, ARENAC, BARAGA, BARRY, BAY, BENZIE, BERRIEN, BRANCH, CALHOUN, CASS, CHARLEVOIX, CHEBOYGAN, CHIPPEWA, CLARE, CLINTON, CRAWFORD, DELTA, DICKINSON, EATON, EMMET, GLADWIN, GOGEBIC, GRAND TRAVERSE, GRATIOT, HILLSDALE, HOUGHTON, HURON, INGHAM, IONIA, IOSCO, IRON, ISABELLA, JACKSON, KALAMAZOO, KALKASKA, KENT, KEWEENAW, LAKE, LAPEER, LEELANAU, LENAWEE, LUCE, MACKINAC, MANISTEE, MARQUETTE, MASON, MECOSTA, MENOMINEE, MIDLAND, MISSAUKEE, MONTCALM, MONTMORENCY, MUSKEGON, NEWAYGO, OCEANA, OGEMAW, ONTONAGON, OSCEOLA, OSCODA, OTSEGO, OTTAWA, PRESQUE ISLE, ROSCOMMON, SANILAC, SCHOOLCRAFT, SHIAWASSEE, ST. CLAIR, ST. JOSEPH, TUSCOLA, VAN BUREN AND WEXFORD COUNTIES

	Rates	Fringes
CEMENT MASON/CONCRETE FINISHER		
ZONE 1.....	\$ 33.00	18.51
ZONE 2.....	\$ 31.50	18.51

 PLUM0190-003 05/01/2015

ALCONA, ALGER, ALLEGAN, ALPENA, ANTRIM, ARENAC, BARAGA, BARRY, BAY, BENZIE, BERRIEN, BRANCH, CALHOUN, CASS, CHARLEVOIX, CHEBOYGAN, CHIPPEWA, CLARE, CLINTON, CRAWFORD, DELTA, DICKINSON, EATON, EMMET, GENESEE, GLADWIN, GOGEBIC, GRAND TRAVERSE, GRATIOT, HILLSDALE, HOUGHTON, HURON, INGHAM, IONIA, IOSCO, IRON, ISABELLA, JACKSON, KALAMAZOO, KALKASKA, KENT, KEWEENAW, LAKE, LAPEER, LEELANAU, LENAWEE, LIVINGSTON, LUCE, MACKINAC, MACOMB, MANISTEE, MARQUETTE, MASON, MECOSTA, MENOMINEE, MIDLAND, MISSAUKEE, MONTCALM, MONTMORENCY, MONROE, MUSKEGON, NEWAYGO, OAKLAND, OCEANA, OGEMAW, ONTONAGON, OSCEOLA, OSCODA, OTSEGO, OTTAWA, PRESQUE ISLE, ROSCOMMON, SAGINAW, ST. CLARE, ST. JOSEPH, SANILAC, SCHOOLCRAFT, SHIAWASSEE, TUSCOLA, VAN BUREN, WASHTENAW, WAYNE AND WEXFORD COUNTIES

	Rates	Fringes
Plumber/Pipefitter - gas		

distribution pipeline:

Welding in conjunction with gas distribution pipeline work.....	\$ 33.03	20.19
All other work:.....	\$ 24.19	12.28

TEAM0007-004 06/01/2024

AREA 1: ALCONA, ALGER, ALLEGAN, ALPENA, ANTRIM, ARENAC, BARAGA, BARRY, BAY, BENZIE, BERRIEN, BRANCH, CALHOUN, CASS, CHARLEVOIX, CHEBOYGAN, CHIPPEWA, CLARE, CLINTON, CRAWFORD, DELTA, DICKINSON, EATON, EMMET, GLADWIN, GOGEBIC, GRAND TRAVERSE, GRATIOT, HILLSDALE, HOUGHTON, HURON, INGHAM, IONIA, IOSCO, IRON, ISABELLA, JACKSON, KALAMAZOO, KALKASKA, KENT, KEWEENAW, LAKE, LAPEER, LEELANAU, LENAWEE, LUCE, MACKINAC, MANISTEE, MARQUETTE, MASON, MECOSTA, MENOMINEE, MIDLAND, MISSAUKEE, MONTCALM, MONTMORENCY, MUSKEGON, NEWAYGO, OCEANA, OGEMAW, ONTONAGON, OSCEOLA, OSCODA, OTSEGO, OTTAWA, PRESQUE ISLE, ROSCOMMON, SAGINAW, SANILAC, SCHOOLCRAFT, SHIAWASSEE, ST. CLAIR, ST. JOSEPH, TUSCOLA, VAN BUREN AND WEXFORD COUNTIES

AREA 2: GENESEE, LIVINGSTON, MACOMB, MONROE, OAKLAND, WASHTENAW AND WAYNE COUNTIES

	Rates	Fringes
TRUCK DRIVER		
AREA 1		
Euclids, double bottoms and lowboys.....	\$ 32.55	.75 + a+b
Trucks under 8 cu. yds.....	\$ 32.30	.75 + a+b
Trucks, 8 cu. yds. and over.....	\$ 32.40	.75 + a+b
AREA 2		
Euclids, double bottoms and lowboys.....	\$ 32.65	.75 + a+b
Trucks under 8 cu. yds.....	\$ 32.40	.75 + a+b
Trucks, 8 cu. yds. and over.....	\$ 32.50	.75 + a+b

Footnote:

- a. \$470.70 per week
- b. \$68.70 daily

TEAM0247-004 04/01/2013

AREA 1: ALCONA, ALGER, ALLEGAN, ALPENA, ANTRIM, ARENAC, BARAGA, BARRY, BAY, BENZIE, BERRIEN, BRANCH, CALHOUN, CASS, CHARLEVOIX, CHEBOYGAN, CHIPPEWA, CLARE, CLINTON, CRAWFORD, DELTA,

DICKINSON, EATON, EMMET, GLADWIN, GOGEBIC, GRAND TRAVERSE, GRATIOT, HILLSDALE, HOUGHTON, HURON, INGHAM, IONIA, IOSCO, IRON, ISABELLA, JACKSON, KALAMAZOO, KALKASKA, KENT, KEWEENAW, LAKE, LAPEER, LEELANAU, LENAWEE, LUCE, MACKINAC, MANISTEE, MARQUETTE, MASON, MECOSTA, MENOMINEE, MIDLAND, MISSAUKEE, MONTCALM, MONTMORENCY, MUSKEGON, NEWAYGO, OCEANA, OGEMAW, ONTONAGON, OSCEOLA, OSCODA, OTSEGO, OTTAWA, PRESQUE ISLE, ROSCOMMON, SANILAC, SCHOOLCRAFT, SHIAWASSEE, SAGINAW, ST. CLAIR, ST. JOSEPH, TUSCOLA, VAN BUREN AND WEXFORD COUNTIES

AREA 2: GENESEE, LIVINGSTON, MACOMB, MONROE, OAKLAND, WASHTENAW AND WAYNE COUNTIES

	Rates	Fringes
Sign Installer		
AREA 1		
GROUP 1.....	\$ 21.78	11.83
GROUP 2.....	\$ 25.27	11.8375
AREA 2		
GROUP 1.....	\$ 22.03	11.83
GROUP 2.....	\$ 25.02	11.8375

FOOTNOTE:

a. \$132.70 per week, plus \$17.80 per day.

SIGN INSTALLER CLASSIFICATIONS:

GROUP 1: performs all necessary labor and uses all tools required to construct and set concrete forms required in the installation of highway and street signs

GROUP 2: performs all miscellaneous labor, uses all hand and power tools, and operates all other equipment, mobile or otherwise, required for the installation of highway and street signs

 TEAM0247-010 04/01/2018

AREA 1: LAPEER AND SHIAWASSEE COUNTIES

AREA 2: GENESEE, MACOMB, MONROE, OAKLAND, ST. CLAIR, WASHTENAW AND WAYNE COUNTIES

Rates	Fringes
-------	---------

TRUCK DRIVER (Underground construction)

AREA 1		
GROUP 1.....	\$ 23.82	19.04
GROUP 2.....	\$ 23.91	19.04
GROUP 3.....	\$ 24.12	19.04
AREA 2		
GROUP 1.....	\$ 24.12	19.04
GROUP 2.....	\$ 24.26	19.04
GROUP 3.....	\$ 24.45	19.04

PAID HOLIDAYS: New Year's Day, Memorial Day, Fourth of July, Labor Day, Thanksgiving Day and Christmas Day.

SCOPE OF WORK: Excavation, site preparation, land balancing, grading, sewers, utilities and improvements; also including but not limited to, tunnels, underground piping, retention, oxidation, flocculation facilities, conduits, general excavation and steel sheeting for underground construction. Underground construction work shall not include any structural modifications, alterations, additions and repairs to buildings or highway work, including roads, streets, bridge construction and parking lots or steel erection.

TRUCK DRIVER CLASSIFICATIONS

GROUP 1: Truck driver on all trucks (EXCEPT dump trucks of 8 cubic yards capacity or over, pole trailers, semis, low boys, Euclid, double bottom and fuel trucks)

GROUP 2: Truck driver on dump trucks of 8 cubic yards capacity or over, pole trailers, semis and fuel trucks

GROUP 3: Truck driver on low boy, Euclid and double bottom

 * SUMI2002-001 05/01/2002

	Rates	Fringes
FLAG PERSON.....	\$ 10.10 **	0.00
LINE PROTECTOR (ZONE 1: GENESEE, MACOMB, MONROE, OAKLAND, WASHTENAW AND WAYNE)....	\$ 22.89	13.45
LINE PROTECTOR (ZONE 2: STATEWIDE (EXCLUDING GENESEE,		

MACOMB, MONROE, OAKLAND, WASHTENAW AND WAYNE).....	\$ 20.19	13.45
Pavement Marking Machine (ZONE 1: GENESEE, MACOMB, MONROE, OAKLAND, WASHTENAW AND WAYNE COUNTIES)		
Group 1.....	\$ 30.52	13.45
Pavement Marking Machine (ZONE 1: GENESEE, MACOMB, MONROE, OAKLAND, WASHTENAW AND WAYNE)		
Group 2.....	\$ 27.47	13.45
Pavement Marking Machine (ZONE 2: STATEWIDE (EXCLUDING GENESEE, MACOMB, MONROE, OAKLAND, WASHTENAW AND WAYNE COUNTIES)		
Group 1.....	\$ 26.92	13.45
Pavement Marking Machine (ZONE 2: STATEWIDE (EXCLUDING GENESEE, MACOMB, MONROE, OAKLAND, WASHTENAW AND WAYNE)		
Group 2.....	\$ 24.23	13.45

WORK CLASSIFICATIONS:

PAVEMENT MARKER GROUP 1: Drives or operates a truck mounted striper, grinder, blaster, groover, or thermoplastic melter for the placement or removal of temporary or permanent pavement markings or markers.

PAVEMENT MARKER GROUP 2: Performs all functions involved for the placement or removal of temporary or permanent pavement markings or markers not covered by the classification of Pavement Marker Group 1 or Line Protector.

LINE PROTECTOR: Performs all operations for the protection or removal of temporary or permanent pavement markings or markers in a moving convoy operation not performed by the classification of Pavement Marker Group 1. A moving convoy operation is comprised of only Pavement Markers Group 1 and Line Protectors.

WELDERS - Receive rate prescribed for craft performing

operation to which welding is incidental.

=====

** Workers in this classification may be entitled to a higher minimum wage under Executive Order 14026 (\$17.20) or 13658 (\$12.90). Please see the Note at the top of the wage determination for more information. Please also note that the minimum wage requirements of Executive Order 14026 are not currently being enforced as to any contract or subcontract to which the states of Texas, Louisiana, or Mississippi, including their agencies, are a party.

Note: Executive Order (EO) 13706, Establishing Paid Sick Leave for Federal Contractors applies to all contracts subject to the Davis-Bacon Act for which the contract is awarded (and any solicitation was issued) on or after January 1, 2017. If this contract is covered by the EO, the contractor must provide employees with 1 hour of paid sick leave for every 30 hours they work, up to 56 hours of paid sick leave each year. Employees must be permitted to use paid sick leave for their own illness, injury or other health-related needs, including preventive care; to assist a family member (or person who is like family to the employee) who is ill, injured, or has other health-related needs, including preventive care; or for reasons resulting from, or to assist a family member (or person who is like family to the employee) who is a victim of, domestic violence, sexual assault, or stalking. Additional information on contractor requirements and worker protections under the EO is available at <https://www.dol.gov/agencies/whd/government-contracts>.

Unlisted classifications needed for work not included within the scope of the classifications listed may be added after award only as provided in the labor standards contract clauses (29CFR 5.5 (a) (1) (iii)).

The body of each wage determination lists the classification and wage rates that have been found to be prevailing for the cited type(s) of construction in the area covered by the wage determination. The classifications are listed in alphabetical order of ""identifiers"" that indicate whether the particular rate is a union rate (current union negotiated rate for local), a survey rate (weighted average rate) or a union average rate (weighted union average rate).

Union Rate Identifiers

A four letter classification abbreviation identifier enclosed in dotted lines beginning with characters other than ""SU"" or ""UAVG"" denotes that the union classification and rate were prevailing for that classification in the survey. Example: PLUM0198-005 07/01/2014. PLUM is an abbreviation identifier of the union which prevailed in the survey for this classification, which in this example would be Plumbers. 0198 indicates the local union number or district council number where applicable, i.e., Plumbers Local 0198. The next number, 005 in the example, is an internal number used in processing the wage determination. 07/01/2014 is the effective date of the most current negotiated rate, which in this example is July 1, 2014.

Union prevailing wage rates are updated to reflect all rate changes in the collective bargaining agreement (CBA) governing this classification and rate.

Survey Rate Identifiers

Classifications listed under the ""SU"" identifier indicate that no one rate prevailed for this classification in the survey and the published rate is derived by computing a weighted average rate based on all the rates reported in the survey for that classification. As this weighted average rate includes all rates reported in the survey, it may include both union and non-union rates. Example: SULA2012-007 5/13/2014. SU indicates the rates are survey rates based on a weighted average calculation of rates and are not majority rates. LA indicates the State of Louisiana. 2012 is the year of survey on which these classifications and rates are based. The next number, 007 in the example, is an internal number used in producing the wage determination. 5/13/2014 indicates the survey completion date for the classifications and rates under that identifier.

Survey wage rates are not updated and remain in effect until a new survey is conducted.

Union Average Rate Identifiers

Classification(s) listed under the UAVG identifier indicate that no single majority rate prevailed for those classifications; however, 100% of the data reported for the classifications was union data. EXAMPLE: UAVG-OH-0010 08/29/2014. UAVG indicates that the rate is a weighted union average rate. OH indicates the state. The next number, 0010 in the example, is an internal number used in producing the wage determination. 08/29/2014 indicates the survey completion date

for the classifications and rates under that identifier.

A UAVG rate will be updated once a year, usually in January of each year, to reflect a weighted average of the current negotiated/CBA rate of the union locals from which the rate is based.

State Adopted Rate Identifiers

Classifications listed under the "SA" identifier indicate that the prevailing wage rate set by a state (or local) government was adopted under 29 C.F.R 1.3(g)-(h). Example: SAME2023-007 01/03/2024. SA reflects that the rates are state adopted. ME refers to the State of Maine. 2023 is the year during which the state completed the survey on which the listed classifications and rates are based. The next number, 007 in the example, is an internal number used in producing the wage determination. 01/03/2024 reflects the date on which the classifications and rates under the "SA" identifier took effect under state law in the state from which the rates were adopted.

WAGE DETERMINATION APPEALS PROCESS

1.) Has there been an initial decision in the matter? This can be:

- * an existing published wage determination
- * a survey underlying a wage determination
- * a Wage and Hour Division letter setting forth a position on a wage determination matter
- * a conformance (additional classification and rate) ruling

On survey related matters, initial contact, including requests for summaries of surveys, should be with the Wage and Hour National Office because National Office has responsibility for the Davis-Bacon survey program. If the response from this initial contact is not satisfactory, then the process described in 2.) and 3.) should be followed.

With regard to any other matter not yet ripe for the formal process described here, initial contact should be with the Branch of Construction Wage Determinations. Write to:

Branch of Construction Wage Determinations
Wage and Hour Division
U.S. Department of Labor
200 Constitution Avenue, N.W.
Washington, DC 20210

2.) If the answer to the question in 1.) is yes, then an interested party (those affected by the action) can request review and reconsideration from the Wage and Hour Administrator (See 29 CFR Part 1.8 and 29 CFR Part 7). Write to:

Wage and Hour Administrator
U.S. Department of Labor
200 Constitution Avenue, N.W.
Washington, DC 20210

The request should be accompanied by a full statement of the interested party's position and by any information (wage payment data, project description, area practice material, etc.) that the requestor considers relevant to the issue.

3.) If the decision of the Administrator is not favorable, an interested party may appeal directly to the Administrative Review Board (formerly the Wage Appeals Board). Write to:

Administrative Review Board
U.S. Department of Labor
200 Constitution Avenue, N.W.
Washington, DC 20210

4.) All decisions by the Administrative Review Board are final.

=====

END OF GENERAL DECISION

For the purposes of this ITB the Construction Type of Highway will apply.

The wage determination applicable to this contract is MI20240001 dated 12-06-2024 attached to this ITB as an appendix.

Conflict Of Interest Disclosure

The City of Ann Arbor Purchasing Policy requires that prospective Vendors complete a Conflict of Interest Disclosure form. A contract may not be awarded to the selected Vendor unless and until the Procurement Unit and the City Administrator have reviewed the Disclosure form and determined that no conflict exists under applicable federal, state, or local law or administrative regulation. Not every relationship or situation disclosed on the Disclosure Form may be a disqualifying conflict. Depending on applicable law and regulations, some contracts may awarded on the recommendation of the City Administrator after full disclosure, where such action is allowed by law, if demonstrated competitive pricing exists and/or it is determined the award is in the best interest of the City. A copy of the Vendor Conflict of Interest Disclosure Form is attached.

Major Subcontractors

The Bidder shall identify on Bid Form Section 4 each major subcontractor it expects to engage for this Contract if the work to be subcontracted is 15% or more of the bid sum or over \$50,000, whichever is less. The Bidder also shall identify the work to be subcontracted to each major subcontractor. The Bidder shall not change or replace a subcontractor without approval by the City.

Debarment

Submission of a Bid in response to this ITB is certification that the Bidder is not currently debarred, suspended, proposed for debarment, and declared ineligible or voluntarily excluded from participation in this transaction by any State or Federal departments or agency. Submission is also agreement that the City will be notified of any changes in this status.

Disclosures

After bids are opened, all information in a submitter's bid is subjected to disclosure under the provisions of Michigan Public Act No. 442 of 1976, as amended (MCL 15.231 et seq.) known as the "Freedom of Information Act." The Freedom of Information Act also provides for the complete disclosure of contracts and attachments thereto except where specifically exempted.

Bid Protest

All Bid protests must be in writing and filed with the Purchasing Manager within five (5) business days of any notices of intent, including, but not exclusively, divisions on prequalification of bidders, shortlisting of bidders, or a notice of intent to award. Only bidders who responded to the solicitation may file a bid protest. The bidder must clearly state the reasons for the protest. If a bidder contacts a City Service Area/Unit and indicates a desire to protest an award, the Service Area/Unit shall refer the bidder to the Purchasing Agent. The Purchasing Agent will provide the bidder with the appropriate instructions for filing the protest. The protest shall be reviewed by the City Administrator or designee whose decision shall be final.

Any inquiries or requests regarding this procurement should be only submitted in writing to the Designated City Contacts provided herein. Attempts by any prospective bidder to initiate contact with anyone other than the Designated City Contacts provided herein that the bidder believes can influence the procurement decision, e.g., Elected Officials, City Administrator, Selection Committee Members, Appointed Committee Members, etc., may lead to immediate elimination from further consideration.

Cost Liability

The City of Ann Arbor assumes no responsibility or liability for costs incurred by the Bidder prior to the execution of a contract with the City. By submitting a bid, a bidder agrees to bear all costs incurred or related to the preparation, submission and selection process for the bid.

Reservation of Rights

The City of Ann Arbor reserves the right to accept any bid or alternative bid proposed in whole or in part, to reject any or all bids or alternatives bids in whole or in part and to waive irregularity and/or informalities in any bid and to make the award in any manner deemed in the best interest of the City.

Idlefree Ordinance

The City of Ann Arbor adopted an idling reduction Ordinance that went into effect July 1, 2017. The full text of the ordinance (including exemptions) can be found at: www.a2gov.org/idlefree.

Under the ordinance, no Operator of a Commercial Vehicle shall cause or permit the Commercial Vehicle to Idle:

- (a) For any period of time while the Commercial Vehicle is unoccupied; or
- (b) For more than 5 minutes in any 60-minute period while the Commercial Vehicle is occupied.

In addition, generators and other internal combustion engines are covered

- (1) Excluding Motor Vehicle engines, no internal combustion engine shall be operated except when it is providing power or electrical energy to equipment or a tool that is actively in use.

Environmental Commitment

The City of Ann Arbor recognizes its responsibility to minimize negative impacts on human health and the environment while supporting a vibrant community and economy. The City further recognizes that the products and services the City buys have inherent environmental and economic impacts and that the City should make procurement decisions that embody, promote, and encourage the City's commitment to the environment.

The City encourages potential vendors to bring forward emerging and progressive products and services that are best suited to the City's environmental principles.

IRS Form W-9

The selected bidder will be required to provide the City of Ann Arbor an fully completed and signed IRS Form W-9.

INVITATION TO BID

City of Ann Arbor
Guy C. Larcom Municipal Building
Ann Arbor, Michigan 48107

Ladies and Gentlemen:

The undersigned, as Bidder, declares that this Bid is made in good faith, without fraud or collusion with any person or persons bidding on the same Contract; that this Bidder has carefully read and examined the bid documents, including City Nondiscrimination requirements and Declaration of Compliance Form, Living Wage requirements and Declaration of Compliance Form, Prevailing Wage requirements and Declaration of Compliance Form, Vendor Conflict of Interest Form, Notice of Pre-Bid Conference, Instructions to Bidders, Bid, Bid Forms, Contract, Bond Forms, General Conditions, Standard Specifications, Detailed Specifications, all Addenda, and the Plans (if applicable) and understands them. The Bidder declares that it conducted a full investigation at the site and of the work proposed and is fully informed as to the nature of the work and the conditions relating to the work's performance. The Bidder also declares that it has extensive experience in successfully completing projects similar to this one.

The Bidder acknowledges that it has not received or relied upon any representations or warrants of any nature whatsoever from the City of Ann Arbor, its agents or employees, and that this Bid is based solely upon the Bidder's own independent business judgment.

The undersigned proposes to perform all work shown on the plans or described in the bid documents, including any addenda issued, and to furnish all necessary machinery, tools, apparatus, and other means of construction to do all the work, furnish all the materials, and complete the work in strict accordance with all terms of the Contract of which this Bid is one part.

In accordance with these bid documents, and Addenda numbered _____, the undersigned, as Bidder, proposes to perform at the sites in and/or around Ann Arbor, Michigan, all the work included herein for the amounts set forth in the Bid Forms.

The Bidder declares that it has become fully familiar with the liquidated damage clauses for completion times and for compliance with City Code Chapter 112, understands and agrees that the liquidated damages are for the non-quantifiable aspects of non-compliance and do not cover actual damages that may be shown and agrees that if awarded the Contract, all liquidated damage clauses form part of the Contract.

The Bidder declares that it has become fully familiar with the provisions of Chapter 14, Section 1:320 (Prevailing wages) and Chapter 23 (Living Wage) of the Code of the City of Ann Arbor and that it understands and agrees to comply, to the extent applicable to employees providing services to the City under this Contract, with the wage and reporting requirements stated in the City Code provisions cited. Bidder certifies that the statements contained in the City Prevailing Wage and Living Wage Declaration of Compliance Forms are true and correct. Bidder further agrees that the cited provisions of Chapter 14 and Chapter 23 form a part of this Contract.

The Bidder declares that it has become familiar with the City Conflict of Interest Disclosure Form and certifies that the statement contained therein is true and correct.

The Bidder encloses a certified check or Bid Bond in the amount of 5% of the total of the Bid Price. The Bidder agrees both to contract for the work and to furnish the necessary Bonds and insurance documentation within 10 days after being notified of the acceptance of the Bid.

If this Bid is accepted by the City and the Bidder fails to contract and furnish the required Bonds and insurance documentation within 10 days after being notified of the acceptance of this Bid, then the Bidder shall be considered to have abandoned the Contract and the certified check or Bid Bond accompanying this Bid shall become due and payable to the City.

If the Bidder enters into the Contract in accordance with this Bid, or if this Bid is rejected, then the accompanying check or Bid Bond shall be returned to the Bidder.

In submitting this Bid, it is understood that the right is reserved by the City to accept any Bid, to reject any or all Bids, to waive irregularities and/or informalities in any Bid, and to make the award in any manner the City believes to be in its best interest.

SIGNED THIS _____ DAY OF _____, 202_.

Bidder's Name

Authorized Signature of Bidder

Official Address

(Print Name of Signer Above)

Telephone Number

Email Address for Award Notice

LEGAL STATUS OF BIDDER

(The Bidder shall fill out the appropriate form and strike out the other three.)

Bidder declares that it is:

* A corporation organized and doing business under the laws of the State of _____, for whom _____, bearing the office title of _____, whose signature is affixed to this Bid, is authorized to execute contracts.

NOTE: If not incorporated in Michigan, please attach the corporation's Certificate of Authority

• A limited liability company doing business under the laws of the State of _____, whom _____ bearing the title of _____ whose signature is affixed to this proposal, is authorized to execute contract on behalf of the LLC.

* A partnership, organized under the laws of the state of _____ and filed in the county of _____, whose members are (list all members and the street and mailing address of each) (attach separate sheet if necessary):

* An individual, whose signature with address, is affixed to this Bid: _____
(initial here)

Authorized Official

_____ **Date** _____, 202_

(Print) Name _____ Title _____

Company: _____

Address: _____

Contact Phone () _____ Fax () _____

Email _____

BID FORM

Section 1 – Schedule of Prices

Company: _____

Project: ITB# 4754 - **Fiber and Conduit Construction for the Ann Arbor/Ypsilanti Broadband Project**

Item	Unit	Estimated Quantity	Unit Price	Total Price
Directional Bore 2 2" Conduits	Per Foot	81,564		
Furnish & Install Muletape in New duct	Per Foot	81,564		
Install #12 Tracer wire	Per Foot	81,564		
Install Fiber Cable in Duct - Including All Slack	Per Foot	90,364		
Remove & Restore Concrete	Sq Ft	2,150		
Install Handhole	Each	86		
Install New Splice Case & Prep Cable	Each	9		
Ground Splice Case	Each	9		
Prep Cable in Panel	Each	3		
Splice Fibers	Each	7,776		
Install Loaded 4u Panel	Each	3		
Terminate Fibers	Each	432		
Test Network	All	1		
Install Marker Post	Each	86		
Install Marker Post with Test Station	Each	28		
Mule tape	Per Foot	81,564		
432 Count Fiber	Per Foot	94,464		
Splice Trays	Each	599		
Splice Cases	Each	9		
Handholes	Each	86		
#12 Tracer Wire	Per Foot	81,564		
Ground Rods	Each	9		
Marker Post	Each	86		
Marker Post with Test Station	Each	28		
2" HDPE Pipe	Per Foot	163,128		
4u Fiber Panels - Loaded	Each	3		

BID TOTAL \$ _____

BID TOTAL (Written) _____

Total bid amount shall be shown in both words and numbers. In case of discrepancies, the amount shown in words shall govern.

Signature of Bidder _____ Date _____

Notice to Bidders

1. Bids must be for all work elements and must have each blank space of the bid form completed.
2. The City reserves the right to waive any informality in any Bid, to reject any Bid, to reject all bids and to delete any part of the above items.
3. The bidder acknowledges that quantities provided are estimates and are not guaranteed and are solely for the propose of bid comparison. Final payment for all unit price items will be based on the actual quantities. No minimum or maximum quantities are guaranteed by the City.
4. The Contractor is responsible for verification of all Bid quantities and to report to the City's Representative any discrepancies found prior to ordering materials or equipment for construction.
5. The bidder hereby certifies it has carefully examined the contract documents provided by the City for bidding purposed and finds them compatible with the work requirements.
6. The bidder declares it has familiarized itself with the location of the proposed work and site conditions.
7. The foregoing unit prices shall include all applicable Federal, State and Local Taxes.

Bidder must sign below that they have read and understood all addendums related to this project. Failure to acknowledge any addendum issued may disqualify the Bidder.

Addendum No.	Addendum Date	Signature of Bidder

BID FORM

Section 2 – Material, Equipment and Environmental Alternates

The Base Bid proposal price shall include materials and equipment selected from the designated items and manufacturers listed in the bidding documents. This is done to establish uniformity in bidding and to establish standards of quality for the items named.

If the Contractor wishes to quote alternate items for consideration by the City, it may do so under this Section. A complete description of the item and the proposed price differential must be provided. Unless approved at the time of award, substitutions where items are specifically named will be considered only as a negotiated change in Contract Sum.

If an environmental alternative is bid the City strongly encourages bidders to provide recent examples of product testing and previous successful use for the City to properly evaluate the environmental alternative. Testing data from independent accredited organizations are strongly preferred.

<u>Item Number</u>	<u>Description</u>	<u>Add/Deduct Amount</u>
--------------------	--------------------	--------------------------

If the Bidder does not suggest any material or equipment alternate, the Bidder **MUST** complete the following statement:

For the work outlined in this request for bid, the bidder does NOT propose any material or equipment alternate under the Contract.

Signature of Authorized Representative of Bidder _____ Date _____

BID FORM

Section 3 - Time Alternate

If the Bidder takes exception to the time stipulated in Article III of the Contract, Time of Completion, page C-2, it is requested to stipulate below its proposed time for performance of the work. Consideration will be given to time in evaluating bids.

If the Bidder does not suggest any time alternate, the Bidder **MUST** complete the following statement:

For the work outlined in this request for bid, the bidder does NOT propose any time alternate under the Contract.

Signature of Authorized Representative of Bidder _____ Date _____

BID FORM

Section 4 - Major Subcontractors

For purposes of this Contract, a Subcontractor is anyone (other than the Contractor) who performs work (other than or in addition to the furnishing of materials, plans or equipment) at or about the construction site, directly or indirectly for or on behalf of the Contractor (and whether or not in privity of Contract with the Contractor), but shall not include any individual who furnishes merely the individual's own personal labor or services.

Contractor agrees that all subcontracts entered into by the Contractor shall contain similar wage provision to Section 4 of the General Conditions covering subcontractor's employees who perform work on this contract.

For the work outlined in these documents the Bidder expects to engage the following major subcontractors to perform the work identified:

<u>Subcontractor (Name and Address)</u>	<u>Work</u>	<u>Amount</u>
---	-------------	---------------

If the Bidder does not expect to engage any major subcontractor, the Bidder **MUST** complete the following statement:

For the work outlined in this request for bid, the bidder does NOT expect to engage any major subcontractor to perform work under the Contract.

Signature of Authorized Representative of Bidder _____ Date _____

BID FORM

Section 6 – Contractor Information and Responsible Contractor Criteria

Backup documentation may be requested at the sole discretion of the City to validate all of the responses provided herein by bidders. False statements by bidders to any of the criteria provided herein will result in the bid being considered non-responsive and will not be considered for award.

Failure to provide responses to all questions may result in being deemed non-responsive.

Attach additional pages as needed if space below is insufficient.

Pursuant to City Code which sets forth requirements of a responsible bidder, Bidder is required to submit the following:

1. Organization Name: _____

Social Security or Federal Employer I.D. #: _____

Address: _____

City: _____ State: _____ Zip: _____

Type of Organization (circle one below):

Individual Partnership Corporation Joint Venture Other

If "Other" please provide details on the organization:

Year organization established: _____

2. Current owners/principals/members/managing members/partners of the organization:

3. Assumed Names, "doing business as" d/b/a, and/or former organization names(s), if applicable: _____

Explanation of any business name changes:

4. If applicable, please provide a list of all bidder's litigation and arbitrations currently pending and within the past five years, including an explanation of each (parties, court/forum, legal claims, damages sought, and resolution).

5. Qualifications of management and supervisory personnel to be assigned by the bidder:

6. List the state and local licenses and license numbers held by the bidder:

7. Will all subcontractors, employees and other individuals working on the construction project maintain current applicable licenses required by law for all licensed occupations and professions?

Yes

No

8. Will contractors, subcontractors, employees, and other individuals working on the construction project be misclassified by bidder as independent contractors in violation of state or federal law?

Yes

No

9. Submit a statement as to what percentage of your work force resides within the City of Ann Arbor, and what percentage resides in Washtenaw County, Michigan, and the same information for any major subcontractors.

10. Submit documentation as to bidder's employee pay rates (e.g., certified payroll without SSN or personal identifying information, or chart of job titles and pay rates, or other evidence).

11. State whether bidder provides health insurance, pension or other retirement benefits, paid leave (vacation, personal time, sick leave, etc), or other benefits to its employees, and if so, state whether each benefit is provided directly to employees, by payments or contributions to a third-party administered plan, in cash (e.g., fringe benefit portion of prevailing wages), or other manner.

12. State whether bidder is an equal opportunity employer and does not discriminate in its hiring on the basis of race, sex, pregnancy, age, religion, national origin, marital status, sexual orientation or gender identity, height, weight, or disability.

Yes

No

13. State whether bidder has Equal Employment Opportunity Programs for minorities, women, veterans, returning citizens, and small businesses, and if so, submit supporting documentation or other evidence of such program(s).

14. Has bidder had any violations of state, federal, or local laws or regulations, including OSHA or MIOSHA violations, state or federal prevailing wage laws, wage and hour laws, worker's compensation or unemployment compensation laws, rules or regulations, issued to or against the bidder within the past five years?

Yes

No

If you answered "yes" to the question above, for each violation provide an explanation of the nature of the violation, the agency involved, a violation or reference number, any other individual(s) or party(ies) involved, and the status or outcome and resolution.

15. Does bidder have an existing Fitness for Duty Program (drugs and alcohol testing) of each employee working on the proposed jobsite?

Yes

No

If you answered "Yes", please submit documentation of the Fitness for Duty Program and what it entails.

16. Submit documents or evidence of any debarment by any federal, state or local governmental unit and/or findings of non-responsibility or non-compliance with respect to any public or private construction project performed by the bidder.

17. Proof of insurance, including certificates of insurance, confirming existence and amount of coverage for liability, property damage, workers compensation, and any other insurances required by the proposed contract documents.

18. Does bidder have an on-going MIOSHA-approved safety-training program for employees to be used on the proposed job site?

Yes

No

If bidder answered "yes" to the question above, submit documentation of your safety-training program.

19. Does bidder have evidence of worker's compensation Experience Modification Rating ("EMR")?

Yes

No

EMR = _____

20. Will bidder use masters, journeypersons and apprentices on the project?

Yes

No

If bidder answered “ yes” to the question above, provide the ratio of masters and journeypersons to apprentices for this project.

Ratio: _____

If bidder answered “no” to the question above, submit documentation regarding the qualifications of each worker who may or will be assigned on the project.

If, yes, Ratio = _____

21. Can bidder provide documentation that it participates in a Registered Apprenticeship Program (RAP) that is registered with the United States Department of Labor Office of Apprenticeship or by a State Apprenticeship Agency recognized by the Office of Apprenticeship?

Yes

No

If bidder answered “yes” to the question above, please submit a copy of the program document(s) and evidence of its registration.

If bidder answered “no” to the question above, please provide details on how you assess the skills and qualifications of any employees who do not have master or journeyperson certification or status, or are not participants in a Registered Apprenticeship Program.

22. Will bidder comply with all applicable state and federal laws and visa requirements regarding the hiring of non-US citizens, and disclosure of any work visas sought or obtained by the bidder, any of the bidder’s subcontractors, or any of the bidder’s employees or independent contractors, in order to perform any portion of the project?

Yes

No

23. Submit evidence that bidder has financial resources to start up and follow through on the project and to respond to damages in case of default as shown by written verification of bonding capacity equal to or exceeding the amount of the bidders scope of work on the project. The written verification must be submitted by a licensed surety company rated B+ or better in the current A.M. Best Guide and qualified to do business within the State of Michigan, and the same audited financial information for any subcontractor estimated to be paid more than \$100,000 related to any portion of the project.

24. Submit evidence of a quality assurance program used by the bidder and the results of same on the bidder's previous projects.

Project

Supervising Professional means the person acting under the authorization of the manager of the Administering Service Area/Unit. At the time this Contract is executed, the Supervising Professional is Joshua Baron, whose job title is Interim IT Director. If there is any question concerning who the Supervising Professional is, Contractor shall confirm with the manager of the Administering Service Area/Unit.

Contractor's Representative means _____ [Insert name] whose job title is [Insert job title].

ARTICLE III - Time of Completion

- (A) The work to be completed under this Contract shall begin immediately on the date specified in the Notice to Proceed issued by the City.
- (B) The entire work for this Contract shall be completed within two hundred eighty (280) consecutive calendar days.
- (C) Failure to complete all the work within the time specified above, including any extension granted in writing by the Supervising Professional, shall obligate the Contractor to pay the City, as liquidated damages and not as a penalty, an amount equal to \$500 for each calendar day of delay in the completion of all the work. If any liquidated damages are unpaid by the Contractor, the City shall be entitled to deduct these unpaid liquidated damages from the monies due the Contractor.

The liquidated damages are for the non-quantifiable aspects of any of the previously identified events and do not cover actual damages that can be shown or quantified nor are they intended to preclude recovery of actual damages in addition to the recovery of liquidated damages.

ARTICLE IV - The Contract Sum

- (A) The City shall pay to the Contractor for the performance of the Contract, the lump sum price as given in the Bid Form in the amount of:

_____ Dollars (\$_____)
- (B) Contractor will be paid by Ann Arbor SPARK from EDA grant pool funds and matching contributions pursuant to the terms of the EDA Grant and Memorandum of Understanding dated 2-7-2022. Pay requests and invoices must be submitted in accordance with General Condition 16 - Progress Payments.
- (C) The amount paid shall be equitably adjusted to cover changes in the work ordered by the Supervising Professional but not required by the Contract Documents. Increases or decreases shall be determined only by written agreement between the City and Contractor.

ARTICLE V - Assignment

This Contract may not be assigned or subcontracted any portion of any right or obligation under this contract without the written consent of the City. Notwithstanding any consent by the City to any assignment, Contractor shall at all times remain bound to all warranties, certifications, indemnifications, promises and performances, however described, as are required of it under this contract unless specifically released from the requirement, in writing, by the City.

ARTICLE VI - Choice of Law

This Contract shall be construed, governed, and enforced in accordance with the laws of the State of Michigan. By executing this Contract, the Contractor and the City agree to venue in a court of appropriate jurisdiction sitting within Washtenaw County for purposes of any action arising under this Contract. The parties stipulate that the venue referenced in this Contract is for convenience and waive any claim of non-convenience.

Whenever possible, each provision of the Contract will be interpreted in a manner as to be effective and valid under applicable law. The prohibition or invalidity, under applicable law, of any provision will not invalidate the remainder of the Contract.

ARTICLE VII - Relationship of the Parties

The parties of the Contract agree that it is not a Contract of employment but is a Contract to accomplish a specific result. Contractor is an independent Contractor performing services for the City. Nothing contained in this Contract shall be deemed to constitute any other relationship between the City and the Contractor.

Contractor certifies that it has no personal or financial interest in the project other than the compensation it is to receive under the Contract. Contractor certifies that it is not, and shall not become, overdue or in default to the City for any Contract, debt, or any other obligation to the City including real or personal property taxes. City shall have the right to set off any such debt against compensation awarded for services under this Contract.

ARTICLE VIII - Notice

All notices given under this Contract shall be in writing, and shall be by personal delivery or by certified mail with return receipt requested to the parties at their respective addresses as specified in the Contract Documents or other address the Contractor may specify in writing. Notice will be deemed given on the date when one of the following first occur: (1) the date of actual receipt; or (2) three days after mailing certified U.S. mail.

ARTICLE IX - Indemnification

To the fullest extent permitted by law, Contractor shall indemnify, defend and hold the City, its officers, employees and agents harmless from all suits, claims, judgments and expenses including attorney's fees resulting or alleged to result, in whole or in part, from any act or omission, which is in any way connected or associated with this Contract, by the Contractor or anyone acting on the Contractor's behalf under this Contract. Contractor shall not be responsible to indemnify the City for losses or damages caused by or resulting from the City's sole negligence. The provisions of this Article shall survive the expiration or earlier termination of this contract for any reason.

ARTICLE X - Entire Agreement

This Contract represents the entire understanding between the City and the Contractor and it supersedes all prior representations, negotiations, agreements, or understandings whether written or oral. Neither party has relied on any prior representations in entering into this Contract. No terms or conditions of either party's invoice, purchase order or other administrative document shall modify the terms and conditions of this Contract, regardless of the other party's failure to object to such form. This Contract shall be binding on and shall inure to the benefit of the parties to this Contract and their permitted successors and permitted assigns and nothing in this Contract, express or implied, is intended to or shall confer on any other person or entity any legal or equitable right, benefit, or remedy of any nature whatsoever under or by reason of this Contract. This Contract may be altered, amended or modified only by written amendment signed by the City and the Contractor.

ARTICLE XI – Electronic Transactions

The City and Contractor agree that signatures on this Contract may be delivered electronically in lieu of an original signature and agree to treat electronic signatures as original signatures that bind them to this Contract. This Contract may be executed and delivered by facsimile and upon such delivery, the facsimile signature will be deemed to have the same effect as if the original signature had been delivered to the other party.

FOR CONTRACTOR

By _____

Its: _____

FOR THE CITY OF ANN ARBOR

By _____
Christopher Taylor, Mayor

By _____
Jacqueline Beaudry, City Clerk

Approved as to substance

By _____
Milton Dohoney Jr, City Administrator

Approved as to form and content

Atleen Kaur, City Attorney

**CITY OF ANN ARBOR
ANN ARBOR-YPSILANTI BROADBAND FIBER AND CONDUIT PROJECT
ECONOMIC DEVELOPMENT ADMINISTRATION INVESTMENT AWARD 06-79-06299**

The EDA Construction Standard Terms and Conditions (March 2021) are incorporated into this Contract as if fully set forth herein.

**CITY OF ANN ARBOR
ANN ARBOR-YPSILANTI BROADBAND FIBER AND CONDUIT PROJECT
ECONOMIC DEVELOPMENT ADMINISTRATION INVESTMENT AWARD 06-79-06299**

**CERTIFICATION REGARDING DEBARMENT,
SUSPENSION AND OTHER RESPONSIBILITY MATTERS**

The undersigned bidder, proposer, contractor, or subcontractor, as appropriate, certifies to the best of its knowledge and belief that neither it nor any of its officers, directors, or managers who will be working under the Contract, or persons or entities holding a greater than 10% equity interest in it (collectively "Principals"):

1. Are presently debarred, suspended, proposed for debarment, declared ineligible, or voluntarily excluded from covered transactions by any federal or state department or agency in the United States;
2. Have within a three-year period preceding this proposal, bid, or agreement been convicted of or had a civil judgment rendered against them for commission of fraud or a criminal offense in connection with obtaining, attempting to obtain, or performing a public (federal, state or local) transaction or contract under a public transaction; violation of federal or state anti-trust or procurement statutes or commission of embezzlement, theft, forgery, bribery, falsification or destruction of records, making false statements, or receiving stolen property;
3. Are presently indicted for or otherwise criminally or civilly charged by a government entity, (federal, state or local) with commission of any of the offenses enumerated in paragraph 2 of this certification; and
4. Have within a three-year period preceding this application/proposal had one or more public transactions (federal, state or local) terminated for cause or default.

The undersigned bidder, proposer, contractor, or subcontractor, as appropriate, certifies that they are "Actively" registered with SAM (System for Award Management) and have been assigned the following Unique Entity Identifier (UEI): _____. The undersigned further certifies that it shall not knowingly enter any transaction with any subcontractor, material supplier, or vendor who is debarred, suspended, declared ineligible, or voluntarily excluded from covered transactions by any federal or state department/agency.

I understand that a false statement on this certification may be grounds for rejection of this proposal or bid, or termination of the award or, in some instances, criminal prosecution.

The Contractor, _____, certifies as stated above:

Signature

Date

Print Title and Name of authorized representative

I am unable to certify to one or more the above statements. Attached is my explanation.

Signature

Date

Print Title and Name of authorized representative

**CITY OF ANN ARBOR
ANN ARBOR-YPSILANTI BROADBAND FIBER AND CONDUIT PROJECT
ECONOMIC DEVELOPMENT ADMINISTRATION INVESTMENT AWARD 06-79-06299**

**31 C.F.R. PART 21 – New Restrictions On Lobbying
CERTIFICATION REGARDING LOBBYING**

The undersigned certifies, to the best of the undersigned's knowledge and belief, that:

1. No Federal appropriated funds have been paid or will be paid, by or on behalf of the undersigned, to any person for influencing or attempting to influence an officer or employee of an agency, a Member of Congress, an officer or employee of Congress, or an employee of a Member of Congress in connection with the awarding of any Federal contract, the making of any Federal grant, the making of any Federal loan, the entering into of any cooperative agreement, or the extension, continuation, renewal, amendment, or modification of any Federal contract, grant, loan, or cooperative agreement.
2. If any funds other than Federal appropriated funds have been paid or will be paid to any person for influencing or attempting to influence an officer or employee of any agency, a Member of Congress, an officer or employee of Congress, or an employee of a Member of Congress in connection with this Federal contract, grant, loan, or cooperative agreement, the undersigned shall complete and submit Standard Form-LLL, "Disclosure Form to Report Lobbying," in accordance with its instructions.
3. The undersigned shall require that the language of this certification be included in the award documents for all subawards at all tiers (including subcontracts, subgrants, and contracts under grants, loans, and cooperative agreements) and that all subrecipients shall certify and disclose accordingly.

This certification is a material representation of fact upon which reliance was placed when this transaction was made or entered into. Submission of this certification is a prerequisite for making or entering into this transaction imposed by Section 1352, Title 31 of the U.S. Code. Any person who fails to file the required certification shall be subject to a civil penalty of not less than \$10,000 and not more than \$100,000 for each such failure.

The Contractor, _____, certifies and affirms the truthfulness and accuracy of each statement of its certification and disclosure, if any. In addition, the Contractor understands and agrees that the provisions of 31 U.S.C. Chapter 38, Administrative Remedies for False Claims and Statements, apply to this certification and disclosure, if any.

Signature of Contractor's Authorized Official

Name and Title of Contractor's Authorized Official

Date

**CITY OF ANN ARBOR
ANN ARBOR-YPSILANTI BROADBAND FIBER AND CONDUIT PROJECT
ECONOMIC DEVELOPMENT ADMINISTRATION INVESTMENT AWARD 06-79-06299**

SAM.GOV INFORMATION

System for Award Management (SAM) SAM.gov record search for Contractor business name and business principal(s) – (*Screenshot of Results*)

PERFORMANCE BOND

- (1) _____ (referred to as "Principal"),
and _____, a corporation duly authorized
to do business in the State of Michigan (referred to as "Surety"), are bound to the City of Ann Arbor,
Michigan (referred to as "City"), for \$ _____, the payment of which Principal and Surety bind
themselves, their heirs, executors, administrators, successors and assigns, jointly and severally,
by this bond.
- (2) The Principal has entered a written Contract with the City entitled _____
_____, for ITB No. _____ and this bond is given for that Contract in compliance with Act No. 213
of the Michigan Public Acts of 1963, as amended, being MCL 129.201 *et seq.*
- (3) Whenever the Principal is declared by the City to be in default under the Contract, the Surety may
promptly remedy the default or shall promptly:
(a) complete the Contract in accordance with its terms and conditions; or
(b) obtain a bid or bids for submission to the City for completing the Contract in accordance with
its terms and conditions, and upon determination by Surety of the lowest responsible bidder,
arrange for a Contract between such bidder and the City, and make available, as work progresses,
sufficient funds to pay the cost of completion less the balance of the Contract price; but not
exceeding, including other costs and damages for which Surety may be liable hereunder, the
amount set forth in paragraph 1.
- (4) Surety shall have no obligation to the City if the Principal fully and promptly performs under the
Contract.
- (5) Surety agrees that no change, extension of time, alteration or addition to the terms of the Contract
or to the work to be performed thereunder, or the specifications accompanying it shall in any way
affect its obligations on this bond, and waives notice of any such change, extension of time,
alteration or addition to the terms of the Contract or to the work, or to the specifications.
- (6) Principal, Surety, and the City agree that signatures on this bond may be delivered electronically
in lieu of an original signature and agree to treat electronic signatures as original signatures that
bind them to this bond. This bond may be executed and delivered by facsimile and upon such
delivery, the facsimile signature will be deemed to have the same effect as if the original signature
had been delivered to the other party.

SIGNED AND SEALED this _____ day of _____, 202_.

(Name of Surety Company)

By _____
(Signature)

Its _____
(Title of Office)

Approved as to form:

Atleen Kaur, City Attorney

(Name of Principal)

By _____
(Signature)

Its _____
(Title of Office)

Name and address of agent:

LABOR AND MATERIAL BOND

- (1) _____
of _____ (referred to as "Principal"), and _____, a corporation duly authorized to do business in the State of Michigan, (referred to as "Surety"), are bound to the City of Ann Arbor, Michigan (referred to as "City"), for the use and benefit of claimants as defined in Act 213 of Michigan Public Acts of 1963, as amended, being MCL 129.201 et seq., in the amount of \$ _____, for the payment of which Principal and Surety bind themselves, their heirs, executors, administrators, successors and assigns, jointly and severally, by this bond.
- (2) The Principal has entered a written Contract with the City entitled _____

_____, for ITB No. _____; and this bond is given for that Contract in compliance with Act No. 213 of the Michigan Public Acts of 1963 as amended;
- (3) If the Principal fails to promptly and fully repay claimants for labor and material reasonably required under the Contract, the Surety shall pay those claimants.
- (4) Surety's obligations shall not exceed the amount stated in paragraph 1, and Surety shall have no obligation if the Principal promptly and fully pays the claimants.
- (5) Principal, Surety, and the City agree that signatures on this bond may be delivered electronically in lieu of an original signature and agree to treat electronic signatures as original signatures that bind them to this bond. This bond may be executed and delivered by facsimile and upon such delivery, the facsimile signature will be deemed to have the same effect as if the original signature had been delivered to the other party.

SIGNED AND SEALED this _____ day of _____, 202_

(Name of Surety Company)
By _____
(Signature)

Its _____
(Title of Office)

Approved as to form:

Atleen Kaur, City Attorney

(Name of Principal)
By _____
(Signature)

Its _____
(Title of Office)

Name and address of agent:

GENERAL CONDITIONS

Section 1 - Execution, Correlation and Intent of Documents

The contract documents shall be signed in 2 copies by the City and the Contractor.

The contract documents are complementary and what is called for by any one shall be binding. The intention of the documents is to include all labor and materials, equipment and transportation necessary for the proper execution of the work. Materials or work described in words which so applied have a well-known technical or trade meaning have the meaning of those recognized standards.

In case of a conflict among the contract documents listed below in any requirement(s), the requirement(s) of the document listed first shall prevail over any conflicting requirement(s) of a document listed later.

(1) Addenda in reverse chronological order; (2) Detailed Specifications; (3) Standard Specifications; (4) Plans; (5) General Conditions; (6) Contract; (7) Bid Forms; (8) Bond Forms; (9) Bid.6

Section 2 - Order of Completion

The Contractor shall submit with each invoice, and at other times reasonably requested by the Supervising Professional, schedules showing the order in which the Contractor proposes to carry on the work. They shall include the dates at which the Contractor will start the several parts of the work, the estimated dates of completion of the several parts, and important milestones within the several parts.

Section 3 - Familiarity with Work

The Bidder or its representative shall make personal investigations of the site of the work and of existing structures and shall determine to its own satisfaction the conditions to be encountered, the nature of the ground, the difficulties involved, and all other factors affecting the work proposed under this Contract. The Bidder to whom this Contract is awarded will not be entitled to any additional compensation unless conditions are clearly different from those which could reasonably have been anticipated by a person making diligent and thorough investigation of the site.

The Bidder shall immediately notify the City upon discovery, and in every case prior to submitting its Bid, of every error or omission in the bidding documents that would be identified by a reasonably competent, diligent Bidder. In no case will a Bidder be allowed the benefit of extra compensation or time to complete the work under this Contract for extra expenses or time spent as a result of the error or omission.

Section 4 - Wage Requirements

Under this Contract, the Contractor shall conform to Chapter 14 of Title I of the Code of the City of Ann Arbor as amended; which in part states "...that all craftsmen, mechanics and laborers employed directly on the site in connection with said improvements, including said employees of

subcontractors, shall receive the prevailing wage for the corresponding classes of craftsmen, mechanics and laborers, as determined by statistics for the Ann Arbor area compiled by the United States Department of Labor. At the request of the City, any contractor or subcontractor shall provide satisfactory proof of compliance with the contract provisions required by the Section.

Pursuant to Resolution R-16-469 all public improvement contractors are subject to prevailing wage and will be required to provide to the City payroll records sufficient to demonstrate compliance with the prevailing wage requirements. A sample Prevailing Wage Form is provided in the Appendix herein for reference as to what will be expected from contractors. Use of the Prevailing Wage Form provided in the Appendix section or a City-approved equivalent will be required along with wage rate interviews.

Where the Contract and the Ann Arbor City Ordinance are silent as to definitions of terms required in determining contract compliance with regard to prevailing wages, the definitions provided in the Davis-Bacon Act as amended (40 U.S.C. 278-a to 276-a-7) for the terms shall be used.

If the Contractor is a "covered employer" as defined in Chapter 23 of the Ann Arbor City Code, the Contractor agrees to comply with the living wage provisions of Chapter 23 of the Ann Arbor City Code. The Contractor agrees to pay those employees providing Services to the City under this Contract a "living wage," as defined in Section 1:815 of the Ann Arbor City Code, as adjusted in accordance with Section 1:815(3); to post a notice approved by the City of the applicability of Chapter 23 in every location in which regular or contract employees providing services under this Contract are working; to maintain records of compliance; if requested by the City, to provide documentation to verify compliance; to take no action that would reduce the compensation, wages, fringe benefits, or leave available to any employee or person contracted for employment in order to pay the living wage required by Section 1:815; and otherwise to comply with the requirements of Chapter 23.

Contractor agrees that all subcontracts entered into by the Contractor shall contain similar wage provision covering subcontractor's employees who perform work on this contract.

Section 5 - Non-Discrimination

The Contractor agrees to comply, and to require its subcontractor(s) to comply, with the nondiscrimination provisions of MCL 37.2209. The Contractor further agrees to comply with the provisions of Section 9:158 of Chapter 112 of Title IX of the Ann Arbor City Code, and to assure that applicants are employed and that employees are treated during employment in a manner which provides equal employment opportunity.

Section 6 - Materials, Appliances, Employees

Unless otherwise stipulated, the Contractor shall provide and pay for all materials, labor, water, tools, equipment, light, power, transportation, and other facilities necessary or used for the execution and completion of the work. Unless otherwise specified, all materials incorporated in the permanent work shall be new, and both workmanship and materials shall be of the highest quality. The Contractor shall, if required, furnish satisfactory evidence as to the kind and quality of materials.

The Contractor shall at all times enforce strict discipline and good order among its employees, and shall seek to avoid employing on the work any unfit person or anyone not skilled in the work assigned.

Adequate sanitary facilities shall be provided by the Contractor.

Section 7 - Qualifications for Employment

The Contractor shall employ competent laborers and mechanics for the work under this Contract. For work performed under this Contract, employment preference shall be given to qualified local residents.

Section 8 - Royalties and Patents

The Contractor shall pay all royalties and license fees. It shall defend all suits or claims for infringements of any patent rights and shall hold the City harmless from loss on account of infringement except that the City shall be responsible for all infringement loss when a particular process or the product of a particular manufacturer or manufacturers is specified, unless the City has notified the Contractor prior to the signing of the Contract that the particular process or product is patented or is believed to be patented.

Section 9 - Permits and Regulations

The Contractor must secure all permits and licenses necessary for the prosecution of the work. These include but are not limited to City building permits, right-of-way permits, lane closure permits, right-of-way occupancy permits, and the like. The City shall pay for such permits and such permit or plan review fees. The City shall secure and pay for easements shown on the plans unless otherwise specified.

The Contractor shall give all notices and comply with all laws, ordinances, rules and regulations bearing on the conduct of the work as drawn and specified. If the Contractor observes that the contract documents are at variance with those requirements, it shall promptly notify the Supervising Professional in writing, and any necessary changes shall be adjusted as provided in the Contract for changes in the work.

Section 10 - Protection of the Public and of Work and Property

The Contractor is responsible for the means, methods, sequences, techniques and procedures of construction and safety programs associated with the work contemplated by this contract. The Contractor, its agents or sub-contractors, shall comply with the "General Rules and Regulations for the Construction Industry" as published by the Construction Safety Commission of the State of Michigan and to all other local, State and National laws, ordinances, rules and regulations pertaining to safety of persons and property.

The Contractor shall take all necessary and reasonable precautions to protect the safety of the public. It shall continuously maintain adequate protection of all work from damage, and shall take all necessary and reasonable precautions to adequately protect all public and private property from injury or loss arising in connection with this Contract. It shall make good any damage, injury or loss to its work and to public and private property resulting from lack of reasonable protective precautions, except as may be due to errors in the contract documents, or caused by agents or employees of the City. The Contractor shall obtain and maintain sufficient insurance to cover damage to any City property at the site by any cause.

In an emergency affecting the safety of life, or the work, or of adjoining property, the Contractor is, without special instructions or authorization from the Supervising Professional, permitted to act at its discretion to prevent the threatened loss or injury. It shall also so act, without appeal, if authorized or instructed by the Supervising Professional.

Any compensation claimed by the Contractor for emergency work shall be determined by agreement or in accordance with the terms of Claims for Extra Cost - Section 15.

Section 11 - Inspection of Work

The City shall provide sufficient competent personnel for the inspection of the work.

The Supervising Professional shall at all times have access to the work whenever it is in preparation or progress, and the Contractor shall provide proper facilities for access and for inspection.

If the specifications, the Supervising Professional's instructions, laws, ordinances, or any public authority require any work to be specially tested or approved, the Contractor shall give the Supervising Professional timely notice of its readiness for inspection, and if the inspection is by an authority other than the Supervising Professional, of the date fixed for the inspection. Inspections by the Supervising Professional shall be made promptly, and where practicable at the source of supply. If any work should be covered up without approval or consent of the Supervising Professional, it must, if required by the Supervising Professional, be uncovered for examination and properly restored at the Contractor's expense.

Re-examination of any work may be ordered by the Supervising Professional, and, if so ordered, the work must be uncovered by the Contractor. If the work is found to be in accordance with the contract documents, the City shall pay the cost of re-examination and replacement. If the work is not in accordance with the contract documents, the Contractor shall pay the cost.

Section 12 - Superintendence

The Contractor shall keep on the work site, during its progress, a competent superintendent and any necessary assistants, all satisfactory to the Supervising Professional. The superintendent will be responsible to perform all on-site project management for the Contractor. The superintendent shall be experienced in the work required for this Contract. The superintendent shall represent the Contractor and all direction given to the superintendent shall be binding as if given to the Contractor. Important directions shall immediately be confirmed in writing to the Contractor. Other directions will be confirmed on written request. The Contractor shall give efficient superintendence to the work, using its best skill and attention.

Section 13 - Changes in the Work

The City may make changes to the quantities of work within the general scope of the Contract at any time by a written order and without notice to the sureties. If the changes add to or deduct from the extent of the work, the Contract Sum shall be adjusted accordingly. All the changes shall be executed under the conditions of the original Contract except that any claim for extension of time caused by the change shall be adjusted at the time of ordering the change.

In giving instructions, the Supervising Professional shall have authority to make minor changes in the work not involving extra cost and not inconsistent with the purposes of the work, but otherwise, except in an emergency endangering life or property, no extra work or change shall be made unless in pursuance of a written order by the Supervising Professional, and no claim for an addition to the Contract Sum shall be valid unless the additional work was ordered in writing.

The Contractor shall proceed with the work as changed and the value of the work shall be determined as provided in Claims for Extra Cost - Section 15.

Section 14 - Extension of Time

Extension of time stipulated in the Contract for completion of the work will be made if and as the Supervising Professional may deem proper under any of the following circumstances:

- (1) When work under an extra work order is added to the work under this Contract;
- (2) When the work is suspended as provided in Section 20;
- (3) When the work of the Contractor is delayed on account of conditions which could not have been foreseen, or which were beyond the control of the Contractor, and which were not the result of its fault or negligence;
- (4) Delays in the progress of the work caused by any act or neglect of the City or of its employees or by other Contractors employed by the City;
- (5) Delay due to an act of Government;
- (6) Delay by the Supervising Professional in the furnishing of plans and necessary information;

- (7) Other cause which in the opinion of the Supervising Professional entitles the Contractor to an extension of time.

The Contractor shall notify the Supervising Professional within 7 days of an occurrence or conditions which, in the Contractor's opinion, entitle it to an extension of time. The notice shall be in writing and submitted in ample time to permit full investigation and evaluation of the Contractor's claim. The Supervising Professional shall acknowledge receipt of the Contractor's notice within 7 days of its receipt. Failure to timely provide the written notice shall constitute a waiver by the Contractor of any claim.

In situations where an extension of time in contract completion is appropriate under this or any other section of the contract, the Contractor understands and agrees that the only available adjustment for events that cause any delays in contract completion shall be extension of the required time for contract completion and that there shall be no adjustments in the money due the Contractor on account of the delay.

Section 15 - Claims for Extra Cost

If the Contractor claims that any instructions by drawings or other media issued after the date of the Contract involved extra cost under this Contract, it shall give the Supervising Professional written notice within 7 days after the receipt of the instructions, and in any event before proceeding to execute the work, except in emergency endangering life or property. The procedure shall then be as provided for Changes in the Work-Section 13. No claim shall be valid unless so made.

If the Supervising Professional orders, in writing, the performance of any work not covered by the contract documents, and for which no item of work is provided in the Contract, and for which no unit price or lump sum basis can be agreed upon, then the extra work shall be done on a Cost-Plus-Percentage basis of payment as follows:

- (1) The Contractor shall be reimbursed for all reasonable costs incurred in doing the work, and shall receive an additional payment of 15% of all the reasonable costs to cover both its indirect overhead costs and profit;
- (2) The term "Cost" shall cover all payroll charges for employees and supervision required under the specific order, together with all worker's compensation, Social Security, pension and retirement allowances and social insurance, or other regular payroll charges on same; the cost of all material and supplies required of either temporary or permanent character; rental of all power-driven equipment at agreed upon rates, together with cost of fuel and supply charges for the equipment; and any costs incurred by the Contractor as a direct result of executing the order, if approved by the Supervising Professional;
- (3) If the extra is performed under subcontract, the subcontractor shall be allowed to compute its charges as described above. The Contractor shall be permitted to add an additional charge of 5% percent to that of the subcontractor for the Contractor's supervision and contractual responsibility;
- (4) The quantities and items of work done each day shall be submitted to the Supervising Professional in a satisfactory form on the succeeding day, and shall be approved by the Supervising Professional and the Contractor or adjusted at once;

- (5) Payments of all charges for work under this Section in any one month shall be made along with normal progress payments. Retainage shall be in accordance with Progress Payments-Section 16.

No additional compensation will be provided for additional equipment, materials, personnel, overtime or special charges required to perform the work within the time requirements of the Contract.

When extra work is required and no suitable price for machinery and equipment can be determined in accordance with this Section, the hourly rate paid shall be 1/40 of the basic weekly rate listed in the Rental Rate Blue Book published by Dataquest Incorporated and applicable to the time period the equipment was first used for the extra work. The hourly rate will be deemed to include all costs of operation such as bucket or blade, fuel, maintenance, "regional factors", insurance, taxes, and the like, but not the costs of the operator.

Section 16 - Progress Payments (Revised)

The Contractor shall submit each month, or at longer intervals, if it so desires, an invoice covering work performed for which it believes payment, under the Contract terms, is due. Invoices shall be submitted to:

[_____INSERT SPARK EMAIL ADDRESS] (Preferred)

or mailed to:

Ann Arbor SPARK
Attn: _____[INSERT NAME]
330 E. Liberty, Lower Level
Ann Arbor, MI 48104

With a copy emailed to:

Joshua Baron, IT Director
City of Ann Arbor
JRBaron@a2gov.org

The Supervising Professional will, within 10 days following submission of the invoice, prepare a certificate for payment for the work in an amount to be determined by the Supervising Professional as fairly representing the acceptable work performed during the period covered by the Contractor's invoice and provide it to Ann Arbor SPARK. To insure the proper performance of this Contract, a percentage of the invoice amount will be retained in accordance with Act 524, Public Acts of 1980. Following receipt of the Supervising Professional's certificate for payment, Ann Arbor SPARK will then, make payment to the Contractor as soon as is feasible, which is anticipated to be within 45 days..

An allowance may be made in progress payments if substantial quantities of permanent material have been delivered to the site but not incorporated in the completed work if the Contractor, in the opinion of the Supervising Professional, is diligently pursuing the work under this Contract. Such materials shall be properly stored and adequately protected. Allowance in the estimate shall be at the invoice price value of the items. Notwithstanding any payment of any allowance, all risk

of loss due to vandalism or any damages to the stored materials remains with the Contractor.

In the case of Contracts which include only the Furnishing and Delivering of Equipment, the payments shall be; 60% of the Contract Sum upon the delivery of all equipment to be furnished, or in the case of delivery of a usable portion of the equipment in advance of the total equipment delivery, 60% of the estimated value of the portion of the equipment may be paid upon its delivery in advance of the time of the remainder of the equipment to be furnished; 30% of the Contract Sum upon completion of erection of all equipment furnished, but not later than 60 days after the date of delivery of all of the equipment to be furnished; and payment of the final 10% on final completion of erection, testing and acceptance of all the equipment to be furnished; but not later than 180 days after the date of delivery of all of the equipment to be furnished, unless testing has been completed and shows the equipment to be unacceptable.

With each invoice for periodic payment, the Contractor shall enclose a Contractor's Declaration - Section 43, and an updated project schedule per Order of Completion - Section 2.

Section 17 - Deductions for Uncorrected Work

If the Supervising Professional decides it is inexpedient to correct work that has been damaged or that was not done in accordance with the Contract, an equitable deduction from the Contract price shall be made.

Section 18 - Correction of Work Before Final Payment

The Contractor shall promptly remove from the premises all materials condemned by the Supervising Professional as failing to meet Contract requirements, whether incorporated in the work or not, and the Contractor shall promptly replace and re-execute the work in accordance with the Contract and without expense to the City and shall bear the expense of making good all work of other contractors destroyed or damaged by the removal or replacement.

If the Contractor does not remove the condemned work and materials within 10 days after written notice, the City may remove them and, if the removed material has value, may store the material at the expense of the Contractor. If the Contractor does not pay the expense of the removal within 10 days thereafter, the City may, upon 10 days written notice, sell the removed materials at auction or private sale and shall pay to the Contractor the net proceeds, after deducting all costs and expenses that should have been borne by the Contractor. If the removed material has no value, the Contractor must pay the City the expenses for disposal within 10 days of invoice for the disposal costs.

The inspection or lack of inspection of any material or work pertaining to this Contract shall not relieve the Contractor of its obligation to fulfill this Contract and defective work shall be made good. Unsuitable materials may be rejected by the Supervising Professional notwithstanding that the work and materials have been previously overlooked by the Supervising Professional and accepted or estimated for payment or paid for. If the work or any part shall be found defective at any time before the final acceptance of the whole work, the Contractor shall forthwith make good the defect in a manner satisfactory to the Supervising Professional. The judgment and the decision of the Supervising Professional as to whether the materials supplied and the work done under this Contract comply with the requirements of the Contract shall be conclusive and final.

Section 19 - Acceptance and Final Payment (Revised)

Upon receipt of written notice that the work is ready for final inspection and acceptance, the Supervising Professional will promptly make the inspection. When the Supervising Professional finds the work acceptable under the Contract and the Contract fully performed, the Supervising Professional will promptly sign and issue a final certificate stating that the work required by this Contract has been completed and is accepted by the City under the terms and conditions of the Contract. The entire balance found to be due the Contractor, including the retained percentage, shall be paid to the Contractor by the Ann Arbor SPARK within 45 days after the date of the final certificate.

Before issuance of final certificates, the Contractor shall file with the City:

- (1) The consent of the surety to payment of the final estimate;
- (2) The Contractor's Affidavit in the form required by Section 44.

In case the Affidavit or consent is not furnished, the City may retain out of any amount due the Contractor, sums sufficient to cover all lienable claims.

The making and acceptance of the final payment shall constitute a waiver of all claims by the City except those arising from:

- (1) unsettled liens;
- (2) faulty work appearing within 12 months after final payment;
- (3) hidden defects in meeting the requirements of the plans and specifications;
- (4) manufacturer's guarantees.

It shall also constitute a waiver of all claims by the Contractor, except those previously made and still unsettled.

Section 20 - Suspension of Work

The City may at any time suspend the work, or any part by giving 5 days notice to the Contractor in writing. The work shall be resumed by the Contractor within 10 days after the date fixed in the written notice from the City to the Contractor to do so. The City shall reimburse the Contractor for expense incurred by the Contractor in connection with the work under this Contract as a result of the suspension.

If the work, or any part, shall be stopped by the notice in writing, and if the City does not give notice in writing to the Contractor to resume work at a date within 90 days of the date fixed in the written notice to suspend, then the Contractor may abandon that portion of the work suspended and will be entitled to the estimates and payments for all work done on the portions abandoned, if any, plus 10% of the value of the work abandoned, to compensate for loss of overhead, plant expense, and anticipated profit.

Section 21 - Delays and the City's Right to Terminate Contract

If the Contractor refuses or fails to prosecute the work, or any separate part of it, with the diligence required to insure completion, ready for operation, within the allowable number of consecutive calendar days specified plus extensions, or fails to complete the work within the required time, the City may, by written notice to the Contractor, terminate its right to proceed with the work or any part of the work as to which there has been delay. After providing the notice the City may take over the work and prosecute it to completion, by contract or otherwise, and the Contractor and its sureties shall be liable to the City for any excess cost to the City. If the Contractor's right to proceed is terminated, the City may take possession of and utilize in completing the work, any materials, appliances and plant as may be on the site of the work and useful for completing the work. The right of the Contractor to proceed shall not be terminated or the Contractor charged with liquidated damages where an extension of time is granted under Extension of Time - Section 14.

If the Contractor is adjudged a bankrupt, or if it makes a general assignment for the benefit of creditors, or if a receiver is appointed on account of its insolvency, or if it persistently or repeatedly refuses or fails except in cases for which extension of time is provided, to supply enough properly skilled workers or proper materials, or if it fails to make prompt payments to subcontractors or for material or labor, or persistently disregards laws, ordinances or the instructions of the Supervising Professional, or otherwise is guilty of a substantial violation of any provision of the Contract, then the City, upon the certificate of the Supervising Professional that sufficient cause exists to justify such action, may, without prejudice to any other right or remedy and after giving the Contractor 3 days written notice, terminate this Contract. The City may then take possession of the premises and of all materials, tools and appliances thereon and without prejudice to any other remedy it may have, make good the deficiencies or finish the work by whatever method it may deem expedient, and deduct the cost from the payment due the Contractor. The Contractor shall not be entitled to receive any further payment until the work is finished. If the expense of finishing the work, including compensation for additional managerial and administrative services exceeds the unpaid balance of the Contract Sum, the Contractor and its surety are liable to the City for any excess cost incurred. The expense incurred by the City, and the damage incurred through the Contractor's default, shall be certified by the Supervising Professional.

Section 22 - Contractor's Right to Terminate Contract

If the work should be stopped under an order of any court, or other public authority, for a period of 3 months, through no act or fault of the Contractor or of anyone employed by it, then the Contractor may, upon 7 days written notice to the City, terminate this Contract and recover from the City payment for all acceptable work executed plus reasonable profit.

Section 23 - City's Right To Do Work

If the Contractor should neglect to prosecute the work properly or fail to perform any provision of this Contract, the City, 3 days after giving written notice to the Contractor and its surety may, without prejudice to any other remedy the City may have, make good the deficiencies and may deduct the cost from the payment due to the Contractor.

Section 24 - Removal of Equipment and Supplies

In case of termination of this Contract before completion, from any or no cause, the Contractor, if notified to do so by the City, shall promptly remove any part or all of its equipment and supplies from the property of the City, failing which the City shall have the right to remove the equipment and supplies at the expense of the Contractor.

The removed equipment and supplies may be stored by the City and, if all costs of removal and storage are not paid by the Contractor within 10 days of invoicing, the City upon 10 days written notice may sell the equipment and supplies at auction or private sale, and shall pay the Contractor the net proceeds after deducting all costs and expenses that should have been borne by the Contractor and after deducting all amounts claimed due by any lien holder of the equipment or supplies.

Section 25 - Responsibility for Work and Warranties

The Contractor assumes full responsibility for any and all materials and equipment used in the construction of the work and may not make claims against the City for damages to materials and equipment from any cause except negligence or willful act of the City. Until its final acceptance, the Contractor shall be responsible for damage to or destruction of the project (except for any part covered by Partial Completion and Acceptance - Section 26). The Contractor shall make good all work damaged or destroyed before acceptance. All risk of loss remains with the Contractor until final acceptance of the work (Section 19) or partial acceptance (Section 26). The Contractor is advised to investigate obtaining its own builders risk insurance.

The Contractor shall guarantee the quality of the work for a period of one year. The Contractor shall also unconditionally guarantee the quality of all equipment and materials that are furnished and installed under the contract for a period of one year. At the end of one year after the Contractor's receipt of final payment, the complete work, including equipment and materials furnished and installed under the contract, shall be inspected by the Contractor and the Supervising Professional. Any defects shall be corrected by the Contractor at its expense as soon as practicable but in all cases within 60 days. Any defects that are identified prior to the end of one year shall also be inspected by the Contractor and the Supervising Professional and shall be corrected by the Contractor at its expense as soon as practicable but in all cases within 60 days. The Contractor shall assign all manufacturer or material supplier warranties to the City prior to final payment. The assignment shall not relieve the Contractor of its obligations under this paragraph to correct defects.

Section 26 - Partial Completion and Acceptance

If at any time prior to the issuance of the final certificate referred to in Acceptance and Final Payment - Section 19, any portion of the permanent construction has been satisfactorily completed, and if the Supervising Professional determines that portion of the permanent construction is not required for the operations of the Contractor but is needed by the City, the Supervising Professional shall issue to the Contractor a certificate of partial completion, and immediately the City may take over and use the portion of the permanent construction described in the certificate, and exclude the Contractor from that portion.

The issuance of a certificate of partial completion shall not constitute an extension of the Contractor's time to complete the portion of the permanent construction to which it relates if the

Contractor has failed to complete it in accordance with the terms of this Contract. The issuance of the certificate shall not release the Contractor or its sureties from any obligations under this Contract including bonds.

If prior use increases the cost of, or delays the work, the Contractor shall be entitled to extra compensation, or extension of time, or both, as the Supervising Professional may determine.

Section 27 - Payments Withheld Prior to Final Acceptance of Work

The City may withhold or, on account of subsequently discovered evidence, nullify the whole or part of any certificate to the extent reasonably appropriate to protect the City from loss on account of:

- (1) Defective work not remedied;
- (2) Claims filed or reasonable evidence indicating probable filing of claims by other parties against the Contractor;
- (3) Failure of the Contractor to make payments properly to subcontractors or for material or labor;
- (4) Damage to another Contractor.

When the above grounds are removed or the Contractor provides a Surety Bond satisfactory to the City which will protect the City in the amount withheld, payment shall be made for amounts withheld under this section.

Section 28 - Contractor's Insurance

- (1) The Contractor shall procure and maintain during the life of this Contract, including the guarantee period and during any warranty work, such insurance policies, including those set forth below, as will protect itself and the City from all claims for bodily injuries, death or property damage that may arise under this Contract; whether the act(s) or omission(s) giving rise to the claim were made by the Contractor, any subcontractor, or anyone employed by them directly or indirectly. Prior to commencement of any work under this contract, Contractor shall provide to the City documentation satisfactory to the City, through City-approved means (currently myCOI), demonstrating it has obtained the required policies and endorsements. The certificates of insurance endorsements and/or copies of policy language shall document that the Contractor satisfies the following minimum requirements. Contractor shall add registration@mycoitracking.com to its safe sender's list so that it will receive necessary communication from myCOI. When requested, Contractor shall provide the same documentation for its subcontractor(s) (if any).

Required insurance policies include:

- (a) Worker's Compensation Insurance in accordance with all applicable state and federal statutes. Further, Employers Liability Coverage shall be obtained in the following minimum amounts:

Bodily Injury by Accident - \$500,000 each accident

Bodily Injury by Disease - \$500,000 each employee
Bodily Injury by Disease - \$500,000 each policy limit

(b) Commercial General Liability Insurance equivalent to, as a minimum, Insurance Services Office form CG 00 01 04 13 or current equivalent. The City of Ann Arbor shall be named as an additional insured. There shall be no added exclusions or limiting endorsements specifically for the following coverages: Products and Completed Operations, Explosion, Collapse and Underground coverage or Pollution. Further there shall be no added exclusions or limiting endorsements that diminish the City's protections as an additional insured under the policy. The following minimum limits of liability are required:

\$1,000,000 Each occurrence as respect Bodily Injury Liability or Property Damage Liability, or both combined.

\$2,000,000 Per Project General Aggregate

\$1,000,000 Personal and Advertising Injury

\$2,000,000 Products and Completed Operations Aggregate, which, notwithstanding anything to the contrary herein, shall be maintained for three years from the date the Project is completed.

(c) Motor Vehicle Liability Insurance, including Michigan No-Fault Coverages, equivalent to, as a minimum, Insurance Services Office form CA 00 01 10 13 or current equivalent. Coverage shall include all owned vehicles, all non-owned vehicles and all hired vehicles. The City of Ann Arbor shall be named as an additional insured. There shall be no added exclusions or limiting endorsements that diminish the City's protections as an additional insured under the policy. Further, the limits of liability shall be \$1,000,000 for each occurrence as respects Bodily Injury Liability or Property Damage Liability, or both combined.

(d) Umbrella/Excess Liability Insurance shall be provided to apply excess of the Commercial General Liability, Employers Liability and the Motor Vehicle coverage enumerated above, for each occurrence and for aggregate in the amount of \$1,000,000.

(2) Insurance required under subsection (1)(b) and (1)(c) above shall be considered primary as respects any other valid or collectible insurance that the City may possess, including any self-insured retentions the City may have; and any other insurance the City does possess shall be considered excess insurance only and shall not be required to contribute with this insurance. Further, the Contractor agrees to waive any right of recovery by its insurer against the City for any insurance listed herein.

(3) Insurance companies and policy forms are subject to approval of the City Attorney, which approval shall not be unreasonably withheld. Documentation must provide and demonstrate an unconditional and un-qualified 30-day written notice of cancellation in favor of the City of Ann Arbor. Further, the documentation must explicitly state the following: (a) the policy number(s); name of insurance company(s); name and address of the agent(s) or authorized representative(s); name(s), email address(es), and address of insured; project name; policy expiration date; and specific coverage amounts; (b) any deductibles or self-insured retentions which may be approved by the City, in its sole discretion; (c) that the policy conforms to the requirements specified Contractor shall furnish the City with satisfactory certificates of insurance and endorsements prior to

commencement of any work. Upon request, the Contractor shall provide within 30 days a copy of the policy(ies) and all required endorsements to the City. If any of the above coverages expire by their terms during the term of this Contract, the Contractor shall deliver proof of renewal and/or new policies and endorsements to the Administering Service Area/Unit at least ten days prior to the expiration date.

- (4) Any Insurance provider of Contractor shall be authorized to do business in the State of Michigan and shall carry and maintain a minimum rating assigned by A.M. Best & Company's Key Rating Guide of "A-" Overall and a minimum Financial Size Category of "V". Insurance policies and certificates issued by non-authorized insurance companies are not acceptable unless approved in writing by the City.
- (5) City reserves the right to require additional coverage and/or coverage amounts as may be included from time to time in the Detailed Specifications for the Project.
- (6) The provisions of General Condition 28 shall survive the expiration or earlier termination of this contract for any reason.

Section 29 - Surety Bonds

Bonds will be required from the successful bidder as follows:

- (1) A Performance Bond to the City of Ann Arbor for the amount of the bid(s) accepted;
- (2) A Labor and Material Bond to the City of Ann Arbor for the amount of the bid(s) accepted.

Bonds shall be executed on forms supplied by the City in a manner and by a Surety Company authorized to transact business in Michigan and satisfactory to the City Attorney.

Section 30 - Damage Claims

The Contractor shall be held responsible for all damages to property of the City or others, caused by or resulting from the negligence of the Contractor, its employees, or agents during the progress of or connected with the prosecution of the work, whether within the limits of the work or elsewhere. The Contractor must restore all property injured including sidewalks, curbing, sodding, pipes, conduit, sewers or other public or private property to not less than its original condition with new work.

Section 31 - Refusal to Obey Instructions

If the Contractor refuses to obey the instructions of the Supervising Professional, the Supervising Professional shall withdraw inspection from the work, and no payments will be made for work performed thereafter nor may work be performed thereafter until the Supervising Professional shall have again authorized the work to proceed.

Section 32 - Assignment

Neither party to the Contract shall assign the Contract without the written consent of the other. The Contractor may assign any monies due to it to a third party acceptable to the City.

Section 33 - Rights of Various Interests

Whenever work being done by the City's forces or by other contractors is contiguous to work covered by this Contract, the respective rights of the various interests involved shall be established by the Supervising Professional, to secure the completion of the various portions of the work in general harmony.

The Contractor is responsible to coordinate all aspects of the work, including coordination of, and with, utility companies and other contractors whose work impacts this project.

Section 34 - Subcontracts

The Contractor shall not award any work to any subcontractor without prior written approval of the City. The approval will not be given until the Contractor submits to the City a written statement concerning the proposed award to the subcontractor. The statement shall contain all information the City may require.

The Contractor shall be as fully responsible to the City for the acts and omissions of its subcontractors, and of persons either directly or indirectly employed by them, as it is for the acts and omissions of persons directly employed by it.

The Contractor shall cause appropriate provisions to be inserted in all subcontracts relative to the work to bind subcontractors to the Contractor by the terms of the General Conditions and all other contract documents applicable to the work of the subcontractors and to give the Contractor the same power to terminate any subcontract that the City may exercise over the Contractor under any provision of the contract documents.

Nothing contained in the contract documents shall create any contractual relation between any subcontractor and the City.

Section 35 - Supervising Professional's Status

The Supervising Professional has the right to inspect any or all work. The Supervising Professional has authority to stop the work whenever stoppage may be appropriate to insure the proper execution of the Contract. The Supervising Professional has the authority to reject all work and materials which do not conform to the Contract and to decide questions which arise in the execution of the work.

The Supervising Professional shall make all measurements and determinations of quantities. Those measurements and determinations are final and conclusive between the parties.

Section 36 - Supervising Professional's Decisions

The Supervising Professional shall, within a reasonable time after their presentation to the Supervising Professional, make decisions in writing on all claims of the City or the Contractor and on all other matters relating to the execution and progress of the work or the interpretation of the contract documents.

Section 37 - Storing Materials and Supplies

Materials and supplies may be stored at the site of the work at locations agreeable to the City unless specific exception is listed elsewhere in these documents. Ample way for foot traffic and drainage must be provided, and gutters must, at all times, be kept free from obstruction. Traffic on streets shall be interfered with as little as possible. The Contractor may not enter or occupy with agents, employees, tools, or material any private property without first obtaining written permission from its owner. A copy of the permission shall be furnished to the Supervising Professional.

Section 38 - Lands for Work

The Contractor shall provide, at its own expense and without liability to the City, any additional land and access that may be required for temporary construction facilities or for storage of materials.

Section 39 - Cleaning Up

The Contractor shall, as directed by the Supervising Professional, remove at its own expense from the City's property and from all public and private property all temporary structures, rubbish and waste materials resulting from its operations unless otherwise specifically approved, in writing, by the Supervising Professional.

Section 40 - Salvage

The Supervising Professional may designate for salvage any materials from existing structures or underground services. Materials so designated remain City property and shall be transported or stored at a location as the Supervising Professional may direct.

Section 41 - Night, Saturday or Sunday Work

No night or Sunday work (without prior written City approval) will be permitted except in the case of an emergency and then only to the extent absolutely necessary. The City may allow night work which, in the opinion of the Supervising Professional, can be satisfactorily performed at night. Night work is any work between 8:00 p.m. and 7:00 a.m. No Saturday work will be permitted unless the Contractor gives the Supervising Professional at least 48 hours but not more than 5 days notice of the Contractor's intention to work the upcoming Saturday.

Section 42 - Sales Taxes

Under State law the City is exempt from the assessment of State Sales Tax on its direct purchases. Contractors who acquire materials, equipment, supplies, etc. for incorporation in City projects are not likewise exempt. State Law shall prevail. The Bidder shall familiarize itself with the State Law and prepare its Bid accordingly. No extra payment will be allowed under this Contract for failure of the Contractor to make proper allowance in this bid for taxes it must pay.

Section 43

CONTRACTOR'S DECLARATION

I hereby declare that I have not, during the period _____, 20___, to _____, 20___, performed any work, furnished any materials, sustained any loss, damage or delay, or otherwise done anything in addition to the regular items (or executed change orders) set forth in the Contract titled _____, for which I shall ask, demand, sue for, or claim compensation or extension of time from the City, except as I hereby make claim for additional compensation or extension of time as set forth on the attached itemized statement. I further declare that I have paid all payroll obligations related to this Contract that have become due during the above period and that all invoices related to this Contract received more than 30 days prior to this declaration have been paid in full except as listed below.

There is/is not (Contractor please circle one and strike one as appropriate) an itemized statement attached regarding a request for additional compensation or extension of time.

Contractor

Date

By _____
(Signature)

Its _____
(Title of Office)

Past due invoices, if any, are listed below.

STANDARD SPECIFICATIONS

All work under this contract shall be performed in accordance with the Public Services Department Standard Specifications in effect at the date of availability of the contract documents stipulated in the Bid. All work under this Contract which is not included in these Standard Specifications, or which is performed using modifications to these Standard Specifications, shall be performed in accordance with the Detailed Specifications included in these contract documents.

Standard Specifications are available online:

<http://www.a2gov.org/departments/engineering/Pages/Engineering-and-Contractor-Resources.aspx>

Detailed Specifications for the Fiber and Conduit Construction for the Ann Arbor/Ypsilanti Broadband Project

A. General Requirements

- a. All work performed by the Contractor shall be in accordance with the City's specifications and all applicable standards included but not limited to the following:
 - i. ANSI, ATIS, ASTM, BOCA, BICSI, EIA, IEEE, MI-OSHA, NEMA NESC, NFPA, OSHA, TIA, UL, and any other applicable industry standard(s).
- b. All Traffic Control needed to perform all portions of the work are the responsibility of the Contractor and shall be included in the cost, regardless of the number of traffic control mobilizations and setups required.
- c. Any damage to and not limited to landscaping, private property, University of Michigan property, roads, curb and gutter, sidewalk, or existing utilities shall be repaired by the Contractor and/or any their sub-contractor(s) immediately at no cost to the project.
- d. The Contractor shall always confine work to ROW property. At no time, shall the Contractor enter private property, University of Michigan property, or perform any work not authorized by the City of Ann Arbor.
- e. The Contractor is responsible for locating all existing underground services including:
 - i. Electric, gas, telephone, data, water, and sewer prior to beginning any underground work. Coordination and compliance with Miss Dig are required.
- f. The Contractor will provide experienced installers who are licensed or certified to install Corning fiber manufactured material.
- g. The Contractor is required to facilitate inspections of work with City of Ann Arbor and the City's designated representative (design, engineering services contractor) that is providing construction oversight under a separate contract. Any deficiencies revealed during inspections by City and/or designated representatives of the City of Ann Arbor, are the sole responsibility of the Contractor to resolve.
- h. When work is completed, the Contractor shall perform continuity testing of optical fibers using OTDR and industry standards for testing. Refer to Section "Acceptance and Testing" for requirements.
 - i. The Contractor shall install necessary lighting protection in accordance with standards.
- j. Bonding on aerial Network segments is required per AT&T and DTE pole attachment agreements. The Contractor must be familiar with AT&T and DTE pole attachment requirements.
- k. Copies of the City's pole attachment agreements with AT&T and with DTE will be provided to the Contractor upon award of the contract.
- l. Grounding for underground Network segments is required at every splice enclosure with a minimum of 8 (eight) feet of grounding rod. Grounding rods must meet applicable industry standard specifications.
- m. The Contractor must ensure adequate clearance exists between proposed fiber build and other utilities, ground, rail, roads, and water. At a minimum the Contractor is required to build conforming to NESC codes.
- n. The Contractor is also responsible to verify local utilities do not have more stringent clearance codes.
- o. The Contractor is responsible for adhering to all right-of-way and utility permitting terms and conditions as set forth in each right-of-way permit.
- p. Any construction changes must be pre-approved by the City of Ann Arbor and the City of Ann Arbor's design and planning contractor before commencing with said change.

Redline edited drawings in AutoCAD format will be required to document any approved changes.

- q. If deficiencies and/or non-compliance issues are discovered by the City of Ann Arbor the Contractor is responsible for the correction.
- r. The Contractor is responsible for all jobsite cleanup and for removal of all spent fiber reels and other materials used during construction.
- s. Any modifications repairs or modifications involving Corning products must adhere to Corning warranty standards.

B. Construction Restoration

- a. The Contractor is responsible for the restoration of the work area, including landscaping, to its original condition after work is complete. Surrounding area must be filled, leveled, and compacted. If grass restoration is required, contractor must apply seed or hydro seed. If work cannot be completed due to unseasonal conditions, the work will be completed when feasible.

C. Utility Engineering Fees and Permits

- a. City Right-Of-Way utility fees will be paid directly by the City of Ann Arbor. Contractors are responsible to coordinate efforts with the utilities involved.

D. Make Ready Fees

- a. Make ready fees will be paid directly by the City of Ann Arbor. Contractors are responsible to coordinate efforts with utilities involved.

E. Cable Pulling

- a. Lateral connections will be spliced into the main fiber ring and will be terminated at a fiber distribution unit located at each location or predetermined termination point.
- b. Install the cable such that the optical and mechanical characteristics of the fiber are not degraded.
- c. The Contractor must comply with the manufacturer's recommended installation temperature, pulling tension and bend radius.
- d. Cables must not violate the minimum bend radius or the maximum tension, both during and after installation. Corner rollers (wheels), if used, must not have radii less than the minimum installation bending radius of the cable. A series array of smaller wheels can be used for accomplishing the bend if the cable manufacturer specifically approves the array.
- e. Use a clutch device to ensure the allowable pulling tension is not exceeded if the cable is pulled by mechanical means. Also, attach a strain gauge to the pulling line at the cable exit location, and at a sufficient distance from the take-up device such that the strain gauge can be read throughout the entire cable pulling operation.
- f. Cables should be fed directly in by hand or over large diameter bends to prevent kinks, small bends, sharp edges, and crossovers. Cable should also be fed out of each pull box in a fashion that minimizes bends. Sufficient slack should be left so that each cable may be trained to its final location free of stress and completely clear of hand-hole openings.
- g. The pulling tension should be continuously monitored to assure that the maximum recommended load is not exceeded. If the expected loads are close to maximum, additional pull boxes should be considered and/or the use of lubricants compatible with the outer jacket material of the cable.
- h. Use entry guide chutes to guide the cable into the pull-box conduit ports.

- i. Only lubricants approved by the cable manufacturer are permitted. Wipe the exposed cable in a pull box, junction box, or cabinet clean of cable lubricant with a cloth, after the cable has been installed.
- j. Fiber optic cable ends must be sealed to prevent the entry of water.

F. Cable Lubricant

- a. For new conduit, lubrication of the conduit before pulling is required— particularly if there are several bends.

G. Cable Splicing

- a. All splices must be fusions splices. Splices shall conform to ANSI/TIA/EIA standards.
- b. All fusion splices will have with a maximum loss of < 0.25 dB unidirectional loss using 1550 nm optical source, a maximum bi-directional average loss of <0.15 dB using 1550 nm optical source.
- c. Similarly, a maximum loss of < 0.30 dB unidirectional loss using 1310 nm optical source, and a maximum bi-directional average loss of <0.20 dB loss using a 1310 nm optical source, shall be achieved. Testing must use industry standard TIA-472D000-B and Measurement Method FOTP78. Refer to section “Acceptance and Testing” for specific requirements on testing.
- d. Each spliced fiber must be packaged in a heat shrinkable splice protection sleeve with strength member. The protection sleeve must cover the splice any bare fiber stripped of its coating. The use of RTV or silicone is strictly prohibited.

H. Labeling and Identification

- a. Identification labels must be supplied by the Contractor and installed by the Contractor(s) on the fiber in each hand-hole and at every point of attachment on utility poles per specifications from the pole owner, per the utility pole attachment agreements, and the City of Ann Arbor requirements listed below.
 - i. Aerial Cables – The Contractor is responsible for supplying and installing aerial cable markers per Utility company specifications and/or pole attachment agreements.
 - ii. Underground Cables and Splice Cables – The Contractor is responsible for supplying and installing underground cable markers identical to the City’s original fiber network construction to identify cable ID or Code, cable type, strand count and distance in feet.

I. Aerial Construction Requirements (If applicable)

- a. Grounding – The Contractor is responsible to ensure proper grounding, bonding, and that lightning protection is installed according to standards.
- b. Aerial Cable - All cable must be supported by support a strand (i.e., messenger cable) per industry standards.
- c. Aerial Cable Slack Requirements -150-foot maintenance loops are required every 1,500 feet, as specified in engineering drawings. Maintenance loops must be dressed and stored properly. All slack shall be physically protected.
- d. Provide aerial service loops with snowshoes in various locations (as specified on engineering drawings) to provide sufficient slack if a repair becomes necessary.
- e. Aerial Cable Lashing - All cable lashing will be double-lashed with 0.038 inches, Type 302 austenitic, non-magnetic, and thermally non-hardening stainless steel with a break strength of at least 115 pounds or 0.045-inch, Type 430 Magnetic, thermally non-hardening ferritic stainless steel with a break strength of at least 125 pounds.

J. Underground Construction Requirements

- a. All fiber buried with directional boring must be a minimum of 4 (four) feet below grade.
- b. Newly installed conduits will be clear of all dirt, foreign matter, water, and debris before cable is installed.
- c. Conduit - For FON segments requiring new conduit installation that conduit must be 3 (three) inch diameter Dura-Line Smooth-wall HDPE Conduit or an equivalent. Provide as an option, conduit with Silicore-TM permanently lubricated lining so greater pulling and jetting distances can be achieved where necessary.
- d. Cables that are run through existing conduit cannot not go through the center of an existing slack loop of cable (fiber/electric/etc.) to render the existing slack loop useless, or so that it could not be taken out of the handhole and uncoiled.
- e. Conduits added to existing handholes, or new handholes, that enter through the side wall need to be concrete sealed so that mud/dirt does not fill the handholes over time. This includes locations where handholes are upgraded with existing infrastructure in place. All conduit entries and handhole cuts need to be sealed up.
- f. Upward angled conduits in handholes need to be at least 8 inches from the bottom of the lid – or some value like that to allow bend radius of cables.
- g. When conduits enter the handhole lower than the bottom lip, they need to have elbows, or sweeps, that get them above the bottom lip. This prevents dirt from getting in and plugging the conduit.
- h. Above Ground Markers - Above ground markers must be installed ~500 feet or a lesser line-of-site along burial path, depending on Network segment geography.
- i. Cable Slack Requirements - Throughout the underground cable plant, pull and store excess cable slack at designated intervals per the engineering drawings.
- j. The Contractor must provide adequate drainage for handholes using a stone-based material.
- k. All underground work needs to be inspected by the City before acceptance. The Contractor is responsible for correcting all deficiencies in their work.

K. Above-Ground Cabinet Construction

- a. Install Corning Cross-Connect Cabinets according to manufacturer's specifications and the City of Ann Arbor's specifications.

L. Materials Specifications

- a. ALL materials required will be supplied and installed by the Contractor, including the following materials, unless otherwise authorized by the City of Ann Arbor:
- b. Fiber Optic Cable
 - i. All fiber optic cables must be indoor/outdoor, plenum-rated cables for inter-building and intra-building backbones in aerial, duct, and riser applications. Deliver the cable on reels without splices. Ensure both ends of the cable are sealed to prevent moisture ingress.
- c. Single Mode Fiber Cable
 - i. ALTOS® Lite Gel-Free, Single-Jacket, Single-
 - ii. Armored Cables, 6-432 Fibers
- d. Communications Tracer wire
 - i. Encore Wire Corporation Tracer Wire HMWPE 45 MIL 600 Volt (UL) DIR – 14AWG
- e. Cable Connectors
 - i. LC connectors are required, providing a small form ceramic ferrule with 1.25 mm ferrule that are easily terminated with any adhesive.
- f. Cable Risers

- i. FREEDOM tight-buffered cable, risers, 48F and 144F, single-mode (OS2), by Corning Optical Communications, or an approved equal.
 - ii. Risers need to be galvanized rigid conduit for the first 10' from grade going up. Then, Schedule 80 PVC is acceptable from that point going up the pole to the aerial attachment location.
- g. Splice Closures
- i. Corning Optics Splice Closure Fiber (SCF) or equivalent, preloaded splice trays that are aerial and underground rated allowing up to 288 single fiber splices. The closure must provide ports for uncut feeder cables and ports for drop cables. The closure, in canister configuration, with a quick-seal mechanical seal port, must allow for rapid and easy addition of cables after initial installation is complete.
- h. Conduit
- i. Three-inch Dura-Line Smoothwall HDPE Conduit or an equivalent is required for each Network segment needing newly installed underground conduit. Dura-Line is made to Industry standards for power and communications applications. It can be installed using open trench methods, HDD (Horizontal Directional Drilled) plowed, or pulled into conduit. Price Smoothwall HDPE conduit with optional Silicore™ permanently lubricated lining, Smoothwall, so ducts can be maximized for greater pulling and jetting distances, reducing the coefficient of friction over standard HDPE conduit.
- i. Handholes
- i. Quazite Handholes. All Handholes at splice locations and underground slack loop locations are 30"x48" double deep, cover test load ratings of 15,000/22,500, box test load rating of 22,500/33,750, minimum.
- j. Closet Connector Housing (CCH) and Patch Panels
- i. Several locations will require CCHs and patch panels. CCHs provide interconnect or cross-connect capabilities between outside plant, riser or distribution cables and opto-electronics. See below for CCH specifications:

Closet Connector Housing (CCH) and Patch Panels Specifications		
Item	Supplier	Description
CCH-04U	Corning Optical	CLOSET CONN HSG 4U F/12 PNLs
WCH-02P	Corning Optical	Wall-MNTD CLST HOUS/2CCH PNL
CCH-01U	Corning Optical	CLOSET CONN HSG 1U F/2 PNLs
CCH-CP24-A9	Corning Optical	CCH PNL W/12 LC DUPLEX SM
CCH-CP12-A9	Corning Optical	CCH PNL W/6 LC DUPLEX SM

M. Acceptance and Testing

- a. The Contractor is required to construct per detailed engineering drawings that will be provided by the City of Ann Arbor after the Design and Planning is completed.
- b. Any deviation from the original design must be requested by the Contractor and approved by the City of Ann Arbor before the work is done.
- c. Deviations to splicing and/or site location terminations must be pre-approved by the City of Ann Arbor and then appropriately documented with red-line drawings and supporting documentation.
- d. All testing results are to be provided and accepted by Corning for the City to maintain its Corning warranty.
- e. The Contractor(s) is required to test the fiber after installation, including all splicing and termination, after completion. Test the fiber from end to end through any interconnections to ensure that the path is properly installed, and that polarization and routing are correct and documented. Out of specification deficiencies identified must be properly corrected per industry standards.
- f. For each network segment or fiber optic link, including spare fibers, determine whether the optical loss is within the limits permissible under applicable testing industry standards below.
- g. A link is defined as a continuous segment of fiber between one connector and another connector.
- h. When testing links that do not have connectors on both ends, the Contractor shall use a mechanical splice to attach a pigtail to the unterminated fiber for the duration of the test.
- i. The following industry testing standards shall be used to verify proper construction and installation:
 - i. Testing industry standard FOTP-78 (Fiber Optic Test Procedure) will be applied to all fiber splicing and unused fibers within the following parameters using the bidirectional method established by FOTP-78, as follows:
 1. All fusion splices will have less than 0.15 dB loss using 1550 nm optical source. The test will be bi-directional with no splice loss being greater than 0.15 dB. Since the test is bi-directional, the splice loss refers to the final loss value obtained once the test results are averaged at each splice; none being greater than 0.15 dB.
 2. Terminations will have loss less than 0.54 dB using 1550 nm and 1310 nm optical source. Testing methods will apply industry standard TIA-472D000-B Section 8.2.1 (Telecommunications Industry Association) using Optical Time Domain Reflectometer (OTDR) as the measurement device.
 3. No manual calculations of bi-directional averages are allowed.
 4. Record and document all splice losses and termination losses and submit to the City of Ann Arbor for approval.
 5. Reflectance should be between -42 and -56 at the panel
 6. All testing must be done using a launch reel no less than 90ft depending on length of fiber run being tested.
 7. OTDR re-certification must be done within 1yr of testing date and date must be included on final testing results.
 - ii. Perform OTDR testing which captures optical attenuation on all fibers after post installation. Optical attenuation performance shall meet or exceed standard TIA472D000-B Section 8.1 for single-mode fiber. The maximum optical attenuation loss cannot exceed 0.25 dB/km at 1550 and 0.35 dB/km 1310 nm testing.

N. Splice Testing Documentation

- a. Documentation of the fiber optic cable plant (test results) should follow ANSI/TIA/EIA-606 Administrative Standard for Telecommunications infrastructure of commercial Buildings. This documentation shall include the insertion loss data.

O. Documentation

- a. Prepare diagrams showing all the links tested in this project. On each line representing a link, show the maximum allowable loss and the actual loss. Ensure the actual loss is the one measured after all corrective actions have been taken.
- b. Provide an OTDR trace for all fibers to document the location of the sources of optical loss in the cable (refer Acceptance and Testing).
- c. All Red-line drawings, field notes, documentation, submitted to City of Ann Arbor in a format acceptable to the City of Ann Arbor (e.g., Spatially- referenced AutoCAD files, GIS shapefile, etc.).
- d. Schematics and detailed circuit diagrams of all splice locations shall be provided in an acceptable format to the City of Ann Arbor.
- e. All fiber testing documentation must be provided to the City and Corning.

P. Warranty and Workmanship

- a. The Contractor warrants that all materials furnished shall be new, and free from defects.
- b. The Contractor warrants that the materials and workmanship used in the construction are as herein specified and shall provide all material and labor required to make good any defects due to faulty materials or workmanship which become apparent within a one-year period from project completion.
- c. The equipment and materials manufacturers are expected to recognize that they are responsible for the failure of their products to perform in accordance with data furnished by them or their authorized representatives, as well as misrepresentations of such data.
- d. When the products have been installed in accordance with the manufacturer's published or written instructions and recommendations, and such products fail, the Contractor is responsible for replacement of the products and all associated work and materials without additional cost to the City of Ann Arbor.
- e. Contractor shall obtain and assign to the City of Ann Arbor warranties from the manufacturers of the materials it installs.
- f. Damage by vandals, fire, traffic accidents or "acts of God" are excluded from labor and materials warranty.

CITY OF ANN ARBOR

LIVING WAGE ORDINANCE DECLARATION OF COMPLIANCE

The Ann Arbor Living Wage Ordinance (Section 1:811-1:821 of Chapter 23 of Title I of the Code) requires that an employer who is (a) a contractor providing services to or for the City for a value greater than \$10,000 for any twelve-month contract term, or (b) a recipient of federal, state, or local grant funding administered by the City for a value greater than \$10,000, or (c) a recipient of financial assistance awarded by the City for a value greater than \$10,000, shall pay its employees a prescribed minimum level of compensation (i.e., Living Wage) for the time those employees perform work on the contract or in connection with the grant or financial assistance. The Living Wage must be paid to these employees for the length of the contract/program.

Companies employing fewer than 5 persons and non-profits employing fewer than 10 persons are exempt from compliance with the Living Wage Ordinance. If this exemption applies to your company/non-profit agency please check here No. of employees _____

The Contractor or Grantee agrees:

- (a) To pay each of its employees whose wage level is not required to comply with federal, state or local prevailing wage law, for work covered or funded by a contract with or grant from the City, no less than the Living Wage. The current Living Wage is defined as \$16.43/hour for those employers that provide employee health care (as defined in the Ordinance at Section 1:815 Sec. 1 (a)), or no less than \$18.32/hour for those employers that do not provide health care. The Contractor or Grantor understands that the Living Wage is adjusted and established annually on April 30 in accordance with the Ordinance and covered employers shall be required to pay the adjusted amount thereafter to be in compliance with Section 1:815(3).

Check the applicable box below which applies to your workforce

- Employees who are assigned to any covered City contract/grant will be paid at or above the applicable living wage without health benefits
- Employees who are assigned to any covered City contract/grant will be paid at or above the applicable living wage with health benefits

- (b) To post a notice approved by the City regarding the applicability of the Living Wage Ordinance in every work place or other location in which employees or other persons contracting for employment are working.
- (c) To provide to the City payroll records or other documentation within ten (10) business days from the receipt of a request by the City.
- (d) To permit access to work sites to City representatives for the purposes of monitoring compliance, and investigating complaints or non-compliance.
- (e) To take no action that would reduce the compensation, wages, fringe benefits, or leave available to any employee covered by the Living Wage Ordinance or any person contracted for employment and covered by the Living Wage Ordinance in order to pay the living wage required by the Living Wage Ordinance.

The undersigned states that he/she has the requisite authority to act on behalf of his/her employer in these matters and has offered to provide the services or agrees to accept financial assistance in accordance with the terms of the Living Wage Ordinance. The undersigned certifies that he/she has read and is familiar with the terms of the Living Wage Ordinance, obligates the Employer/Grantee to those terms and acknowledges that if his/her employer is found to be in violation of Ordinance it may be subject to civil penalties and termination of the awarded contract or grant of financial assistance.

Company Name

Street Address

Signature of Authorized Representative

Date

City, State, Zip

Print Name and Title

Phone/Email address

CITY OF ANN ARBOR LIVING WAGE ORDINANCE

RATE EFFECTIVE APRIL 30, 2024 - ENDING APRIL 29, 2025

\$16.43 per hour

If the employer provides health care benefits*

\$18.32 per hour

If the employer does **NOT** provide health care benefits*

Employers providing services to or for the City of Ann Arbor or recipients of grants or financial assistance from the City of Ann Arbor for a value of more than \$10,000 in a twelve-month period of time must pay those employees performing work on a City of Ann Arbor contract or grant, the above living wage.

ENFORCEMENT

The City of Ann Arbor may recover back wages either administratively or through court action for the employees that have been underpaid in violation of the law. Persons denied payment of the living wage have the right to bring a civil action for damages in addition to any action taken by the City.

Violation of this Ordinance is punishable by fines of not more than \$500/violation plus costs, with each day being considered a separate violation. Additionally, the City of Ann Arbor has the right to modify, terminate, cancel or suspend a contract in the event of a violation of the Ordinance.

* Health Care benefits include those paid for by the employer or making an employer contribution toward the purchase of health care. The employee contribution must not exceed \$.50 an hour for an average work week; and the employer cost or contribution must equal no less than \$1/hr for the average work week.

The Law Requires Employers to Display This Poster Where Employees Can Readily See It.

**For Additional Information or to File a Complaint contact
Colin Spencer at 734/794-6500 or cspencer@a2gov.org**



Vendor Conflict of Interest Disclosure Form

All vendors interested in conducting business with the City of Ann Arbor must complete and return the Vendor Conflict of Interest Disclosure Form in order to be eligible to be awarded a contract. Please note that all vendors are subject to comply with the City of Ann Arbor's conflict of interest policies as stated within the certification section below.

If a vendor has a relationship with a City of Ann Arbor official or employee, an immediate family member of a City of Ann Arbor official or employee, the vendor shall disclose the information required below.

1. No City official or employee or City employee's immediate family member has an ownership interest in vendor's company or is deriving personal financial gain from this contract.
2. No retired or separated City official or employee who has been retired or separated from the City for less than one (1) year has an ownership interest in vendor's Company.
3. No City employee is contemporaneously employed or prospectively to be employed with the vendor.
4. Vendor hereby declares it has not and will not provide gifts or hospitality of any dollar value or any other gratuities to any City employee or elected official to obtain or maintain a contract.
5. Please note any exceptions below:

Conflict of Interest Disclosure*	
Name of City of Ann Arbor employees, elected officials or immediate family members with whom there may be a potential conflict of interest.	<input type="checkbox"/> Relationship to employee <hr/> <input type="checkbox"/> Interest in vendor's company <input type="checkbox"/> Other (please describe in box below)

*Disclosing a potential conflict of interest does not disqualify vendors. In the event vendors do not disclose potential conflicts of interest and they are detected by the City, vendor will be exempt from doing business with the City.

I certify that this Conflict of Interest Disclosure has been examined by me and that its contents are true and correct to my knowledge and belief and I have the authority to so certify on behalf of the Vendor by my signature below:		
Vendor Name	Vendor Phone Number	
Signature of Vendor Authorized Representative	Date	Printed Name of Vendor Authorized Representative

Questions about this form? Contact Procurement Office City of Ann Arbor Phone: 734/794-6500, procurement@a2gov.org

CITY OF ANN ARBOR NON-DISCRIMINATION ORDINANCE

Relevant provisions of Chapter 112, Nondiscrimination, of the Ann Arbor City Code are included below.
You can review the entire ordinance at www.a2gov.org/humanrights.

Intent: It is the intent of the city that no individual be denied equal protection of the laws; nor shall any individual be denied the enjoyment of his or her civil or political rights or be discriminated against because of actual or perceived age, arrest record, color, disability, educational association, familial status, family responsibilities, gender expression, gender identity, genetic information, height, HIV status, marital status, national origin, political beliefs, race, religion, sex, sexual orientation, source of income, veteran status, victim of domestic violence or stalking, or weight.

Discriminatory Employment Practices: No person shall discriminate in the hire, employment, compensation, work classifications, conditions or terms, promotion or demotion, or termination of employment of any individual. No person shall discriminate in limiting membership, conditions of membership or termination of membership in any labor union or apprenticeship program.

Discriminatory Effects: No person shall adopt, enforce or employ any policy or requirement which has the effect of creating unequal opportunities according to actual or perceived age, arrest record, color, disability, educational association, familial status, family responsibilities, gender expression, gender identity, genetic information, height, HIV status, marital status, national origin, political beliefs, race, religion, sex, sexual orientation, source of income, veteran status, victim of domestic violence or stalking, or weight for an individual to obtain housing, employment or public accommodation, except for a bona fide business necessity. Such a necessity does not arise due to a mere inconvenience or because of suspected objection to such a person by neighbors, customers or other persons.

Nondiscrimination by City Contractors: All contractors proposing to do business with the City of Ann Arbor shall satisfy the contract compliance administrative policy adopted by the City Administrator in accordance with the guidelines of this section. All city contractors shall ensure that applicants are employed and that employees are treated during employment in a manner which provides equal employment opportunity and tends to eliminate inequality based upon any classification protected by this chapter. All contractors shall agree not to discriminate against an employee or applicant for employment with respect to hire, tenure, terms, conditions, or privileges of employment, or a matter directly or indirectly related to employment, because of any applicable protected classification. All contractors shall be required to post a copy of Ann Arbor's Non-Discrimination Ordinance at all work locations where its employees provide services under a contract with the city.

Complaint Procedure: If any individual believes there has been a violation of this chapter, he/she may file a complaint with the City's Human Rights Commission. The complaint must be filed within 180 calendar days from the date of the individual's knowledge of the allegedly discriminatory action or 180 calendar days from the date when the individual should have known of the allegedly discriminatory action. A complaint that is not filed within this timeframe cannot be considered by the Human Rights Commission. To file a complaint, first complete the complaint form, which is available at www.a2gov.org/humanrights. Then submit it to the Human Rights Commission by e-mail (hrc@a2gov.org), by mail (Ann Arbor Human Rights Commission, PO Box 8647, Ann Arbor, MI 48107), or in person (City Clerk's Office). For further information, please call the commission at 734-794-6141 or e-mail the commission at hrc@a2gov.org.

Private Actions For Damages or Injunctive Relief: To the extent allowed by law, an individual who is the victim of discriminatory action in violation of this chapter may bring a civil action for appropriate injunctive relief or damages or both against the person(s) who acted in violation of this chapter.

THIS IS AN OFFICIAL GOVERNMENT NOTICE AND
MUST BE DISPLAYED WHERE EMPLOYEES CAN READILY SEE IT.

MICHIGAN DEPARTMENT OF TRANSPORTATION CERTIFIED PAYROLL

COMPLETION OF CERTIFIED PAYROLL FORM FULFILLS THE MINIMUM MDOT PREVAILING WAGE REQUIREMENTS

(1) NAME OF CONTRACTOR / SUBCONTRACTOR (IF MORE THAN ONE)		(2) ADDRESS		(3) PAYROLL ID		(4) FOR WEEK ENDING		(5) PROJECT AND LOCATION		(6) CONTRACT ID			
(a) EMPLOYEE INFORMATION	(b) WORK CLASSIFICATION	(c) CURR. TYPE	(d) DAILY AND DATE		(e) TOTAL HOURS ON PROJECT	(f) PROJECT RATE OF PAY	(g) PROJECT RATE OF CHANGE PAY	(h) GROSS PROJECT EARNED	(i) TOTAL WEEKLY HOURS WORKED	(j) DEDUCTIONS		(k) TOTAL WEEKLY WAGES PAID FOR ALL JOBS	
NAME:										FICA	FEDERAL STATE	OTHER	TOTAL DEDUCT
ETH-GEN: ID #:	GROUP/CLASS #:	\$			0			\$0.00					\$0.00
ETH-GEN: ID #:	GROUP/CLASS #:	\$			0			\$0.00					\$0.00
ETH-GEN: ID #:	GROUP/CLASS #:	\$			0			\$0.00					\$0.00
ETH-GEN: ID #:	GROUP/CLASS #:	\$			0			\$0.00					\$0.00
ETH-GEN: ID #:	GROUP/CLASS #:	\$			0			\$0.00					\$0.00
ETH-GEN: ID #:	GROUP/CLASS #:	\$			0			\$0.00					\$0.00
ETH-GEN: ID #:	GROUP/CLASS #:	\$			0			\$0.00					\$0.00
ETH-GEN: ID #:	GROUP/CLASS #:	\$			0			\$0.00					\$0.00
ETH-GEN: ID #:	GROUP/CLASS #:	\$			0			\$0.00					\$0.00
ETH-GEN: ID #:	GROUP/CLASS #:	\$			0			\$0.00					\$0.00
ETH-GEN: ID #:	GROUP/CLASS #:	\$			0			\$0.00					\$0.00
ETH-GEN: ID #:	GROUP/CLASS #:	\$			0			\$0.00					\$0.00

**U.S. DEPARTMENT OF COMMERCE
ECONOMIC DEVELOPMENT ADMINISTRATION**

STANDARD TERMS AND CONDITIONS FOR CONSTRUCTION PROJECTS

Title II of the Public Works and Economic Development Act of 1965

Public Works and Economic Development Facilities
and
Economic Adjustment Assistance Construction Components



March 22, 2021

Table of Contents

PART I: GENERAL PROVISIONS	4
A. Construction Award Purpose	4
B. Authorities.....	4
1. In General.....	4
2. PWEDA	4
3. EDA Regulations	4
4. Conflicts Among Authorities	4
C. Updates to Authorities.....	4
1. Updates to Regulations and Requirements	4
2. Applicability to the Award.....	5
D. Variances	5
E. Recipient as Trustee.....	5
F. Additional Funding	5
G. Definitions	5
H. Reaffirmation of Application and Award Acceptance.....	5
PART II: SPECIAL REQUIREMENTS FOR EDA CONSTRUCTION PROJECTS	7
A. Financial Requirements	7
1. Financial Reports	7
2. Disbursements.....	7
3. Federal and Non-Federal Cost Sharing	8
4. Budget Revisions and Transfer of Funds	8
5. Indirect Costs and Facilities and Administrative Costs	9
6. Incurring Costs Prior to Award.....	10
7. Program Income.....	10
B. Programmatic Requirements	10
1. Project Progress and Performance Reporting	10
2. Time Extensions.....	11
3. Interim Reporting of Significant Project Developments.....	12
4. Programmatic Changes	12
5. Government Performance and Results Act.....	12
6. Beneficiary Compliance.....	13
7. Hold Harmless	13
8. Prohibition on Use of Third Parties to Secure Award.....	13
9. Payment of Attorneys' or Consultants' Fees	13
10. Recipient's Duty to Refrain from Employing Certain Government Employees.....	13
11. Commencement of Construction	14
12. Project Sign and Use of EDA Logo	14
13. Efficient Administration of Project.....	15
14. Conflicts-of-Interest Rules	15

15.	Records-Keeping Requirements	16
16.	Termination Actions	17
17.	Project Closeout Procedures	18
18.	Freedom of Information Act	20
C.	Additional Requirements Related to Construction Projects	20
1.	The Davis-Bacon Act, as amended (40 U.S.C. §§ 3141–3144, 3146, 3147; 42 U.S.C. § 3212)	20
2.	The Contract Work Hours and Safety Standards Act, as amended (40 U.S.C. §§ 3701-3708)	20
3.	The National Historic Preservation Act of 1966, as amended (54 U.S.C. § 300101 et seq.), and the Advisory Council on Historic Preservation Guidelines (36 CFR part 800)	20
4.	Preservation of Historical and Archeological Data (54 U.S.C. § 312502)	20
5.	The Architectural Barriers Act of 1968, as amended (42 U.S.C. § 4151 et seq.)	21
6.	The Uniform Relocation Assistance and Real Property Acquisition Policies Act of 1970, as amended (42 U.S.C. § 4601 et seq.)	21
7.	The Energy Conservation and Production Act (42 U.S.C. § 6834 et seq.)	21
8.	Executive Order 13717, “Seismic Safety of Federal and Federally Assisted or Regulated New Building Construction”	21
9.	Compliance with Local Construction Requirements	21
D.	Non-Discrimination Requirements	21
E.	Audits	21
1.	General	21
2.	Requirement to Submit a Copy of the Audit to EDA	22
F.	Tribal Employment Rights Ordinances	22
G.	EDA Contracting Provisions for Construction Projects	22
H.	Property	22
1.	Standards	22
2.	Title	23
3.	EDA’s Interest in Award Property	23
4.	Insurance and Bonding	25
5.	Leasing Restrictions	25
6.	Eminent Domain	26
7.	Disposal of Real Property	26
8.	Reporting on Property	26
I.	Environmental Requirements	27
1.	General	27
2.	Compliance with Other Applicable Environmental Requirements	27
J.	American-Made Equipment and Products	28
	PART III: DEPARTMENT OF COMMERCE STANDARD TERMS AND CONDITIONS	29

**PART I:
GENERAL PROVISIONS**

A. Construction Award Purpose

This financial assistance award (the Award), executed by the Economic Development Administration (EDA) and the recipient (Recipient or non-Federal entity), is awarded for the purpose of carrying out the design, engineering, or construction of certain physical infrastructure as specifically set forth in the Award's scope of work.

B. Authorities

1. In General

Recipient must administer this Award in conformance with the terms of the Award, including any properly executed amendment thereto, the EDA-approved budget and scope of work, these EDA Standard Terms and Conditions for Construction Projects (EDA Construction STCs) and the Department of Commerce (DOC) Financial Assistance Standard Terms and Conditions (DOC Standard Terms and Conditions), as well as any specific award conditions; relevant policies issued by EDA; applicable Federal statutes, regulations, and Executive Orders; and the provisions of the Office of Management and Budget (OMB) *Uniform Administrative Requirements, Cost Principles, and Audit Requirements for Federal Awards* codified at 2 CFR part 200 (OMB Uniform Guidance).

2. PWEDA

The Public Works and Economic Development program is authorized under section 201 and the Economic Adjustment Assistance program is authorized under section 209 of PWEDA (42 U.S.C. §§ 3141 and 3149, respectively).

3. EDA Regulations

The regulations implementing PWEDA are contained in chapter III of title 13 of the Code of Federal Regulations (CFR), and apply in full to this Award. The regulations specific to EDA construction projects can be found at 13 CFR parts 305 and 314, and subpart A to part 307.

4. Conflicts Among Authorities

Any inconsistency or conflict among the authorities governing the Recipient's administration of this Award will be resolved in the following order of precedence: Federal laws and regulations (including the OMB Uniform Guidance), applicable notices published in the *Federal Register*, Executive Orders, OMB circulars, these EDA Construction STCs, specific award conditions, and any written policy guidance issued by EDA. However, a specific award condition may amend or take precedence over a provision of these EDA Construction STCs on a case-by-case basis, when warranted by the specific circumstances of the Award. In the event of a conflict between Parts I or II of these EDA Construction STCs and Part III, which incorporates the DOC Standard Terms and Conditions, Parts I and II will control.

C. Updates to Authorities

1. Updates to Regulations and Requirements

The DOC, EDA, or OMB may issue changes from time to time to the regulations and other policies and requirements that apply to this Award. Such changes may upon occasion increase

administrative or programmatic flexibility in administering this Award in a manner that is mutually beneficial to EDA and the Recipient. In addition, if required by law, these changes may impose new requirements. The implementation of any such regulatory, administrative, or programmatic change in administering this Award requires EDA's prior written approval.

2. Applicability to the Award

These EDA Construction STCs apply to the Award as of the Federal award date, as defined at 2 CFR § 200.1, or, if attached to the Award by amendment, as of the effective date of such amendment.

D. Variances

EDA's policy is to administer all awards uniformly; however, there may be special circumstances that warrant a variance. To accommodate these circumstances and to encourage innovative and creative ways to address economic development problems, EDA will consider requests for variances to the procedures set out in these EDA Construction STCs if they do not conflict with applicable Federal statutory and regulatory requirements, are consistent with the goals of EDA's programs, and make sound economic and financial sense. Any approved variance will be implemented through a specific award condition incorporated under the Award.

E. Recipient as Trustee

The Recipient holds grant funds and any property acquired or improved with EDA assistance in trust for the public purposes of an Award. The Recipient's obligation to the Federal Government continues for the estimated useful life of the Project, as determined by EDA, during which EDA retains an undivided equitable reversionary interest (the Federal Interest) in property acquired or improved, in whole or in part, with EDA investment assistance. *See* 13 CFR § 314.2 ("Federal Interest").

If EDA determines that the Recipient fails or has failed to meet this obligation, EDA may exercise any rights or remedies with respect to its Federal Interest in the Project. However, EDA's forbearance in exercising any right or remedy in connection with the Federal Interest does not constitute a waiver thereof.

F. Additional Funding

EDA has no obligation to provide any additional funding in connection with the Award. Any change to the Award to increase funding or to extend the period of performance is at the discretion of EDA, subject to the availability of funds, via an amendment executed by the Grants Officer.

G. Definitions

Capitalized terms and acronyms used but not otherwise defined in these EDA Construction STCs have the meaning ascribed to them at 13 CFR §§ 300.3, 302.20, 307.8, and 314.1, and subpart A to 2 CFR part 200.

H. Reaffirmation of Application and Award Acceptance

By accepting this Award, the Recipient's authorized representative hereby reaffirms and states that:

1. All data in the Application were true and correct when the Application was submitted and remain

- true and correct as of the date of this Award;
2. The Application was, as of the date of submission and the date of this Award, duly authorized as required by local law by the governing body of the Recipient; and
 3. The Recipient has read, understood, and will comply with all terms of this Award, including the assurances and certifications submitted as part of the Application (including assurances submitted through the System for Award Management (SAM.gov)).

Acceptance of the Award is established by any action on the part of the Recipient indicating an intent to accept the Award, including by signing the Financial Assistance Award (Form CD-450) (either via a “wet” signature or electronically) or by requesting any disbursement of Award funds. “Application” means all forms, documentation, and any information submitted to EDA as part and in furtherance of a request for an Award and includes submissions made in response to any request by EDA after submission of the initial Application.

**PART II:
SPECIAL REQUIREMENTS FOR EDA CONSTRUCTION PROJECTS**

A. Financial Requirements

1. Financial Reports

- a. During the period of performance, the Recipient must submit financial reports as follows, unless otherwise specified in a specific award condition.
 - i. *Reports on Award reimbursements.* In accordance with 2 CFR § 200.328 (“Financial reporting”), the Recipient must submit a “Federal Financial Report” (Form SF-425 or any successor form) on a semi-annual basis for the periods ending March 31 and September 30, or any portion thereof, unless otherwise specified in a specific award condition. Reports are due no later than 30 calendar days following the end of each reporting period, and instructions for completing and submitting Form SF-425 will be discussed during the Project kick-off meeting. Recipients may contact their EDA Project Officer with questions on how to complete or submit the report, if necessary, but they must submit reports on time and are encouraged to pose such questions sufficiently before the deadline to allow for complete, accurate, and timely submission of required reports.
 - ii. *Reports on Award advances.* While EDA generally does not advance funds, when the agency does so, the Recipient must submit Form SF-425 within 15 business days following the end of each quarter for an award where the Federal share of costs is under \$1 million. In accordance with 2 CFR § 200.328, because of increased risk and the need to ensure the appropriate use of Federal funds, where EDA advances funds under an award where the Federal share of costs is \$1 million or more the Recipient must submit Form SF-425 within 15 business days following the end of each month, or as otherwise specified in a specific award condition.
- b. The Recipient must submit a final Form SF-425 no later than 120 calendar days after the end date of the period of performance. *See also* Part II, section B.16.c “Final reporting deadline” of these EDA Construction STCs.
- c. Noncompliance with the financial reporting requirements may result in appropriate enforcement action under this Award, including but not limited to suspension of Award payments, disallowance of costs or termination of an award. A Recipient’s non-compliance with financial reporting requirements will also be taken into account in EDA’s consideration of any future applications for EDA financial assistance (*see* 2 CFR § 200.206(b)(2)(iii) and section A.06 (Unsatisfactory Performance or Non-Compliance with Award Provisions) of the DOC Standard Terms and Conditions, which are incorporated in Part III of these EDA Construction STCs).
- d. Financial reports should be submitted to the Project Officer in electronic format, unless otherwise specified in the specific award conditions.

2. Disbursements

- a. *Method of payment.* The Grants Officer determines the appropriate method of payment.

Unless otherwise specified in a specific award condition, the method of payment under this Award will be reimbursement. Payments will be made through electronic funds transfers directly to the Recipient's bank account and in accordance with the requirements of the Debt Collection Improvement Act of 1996 (31 U.S.C. § 3720B *et seq.*). The Award number must be included on all payment-related correspondence, information, and forms.

- b. *Disbursement requests.* The Recipient must use Form SF-271, "Outlay Report and Request for Reimbursement for Construction Programs," to request reimbursement under the Award. Substantiating invoices and/or vouchers also must be provided. Each request for the disbursement of funds must be made to the Project Officer. Form SF-271 can be downloaded from the Grants.gov post-award reporting forms website at <https://www.grants.gov/web/grants/forms/post-award-reporting-forms.html>.
 - i. *Initial disbursement request.* For the initial disbursement only, the Recipient must complete and submit Form SF-3881, "ACH Vendor/Miscellaneous Payment Enrollment Form," along with Form SF-271, to the Project Officer.
 - ii. *Interim disbursement requests.* All requests for interim disbursement must be submitted using Form SF-271 and include substantiating invoices and/or vouchers.
 - iii. *Final disbursement request.* See Part II, section B.16 "Project Closeout Procedures" of these EDA Construction STCs.

3. **Federal and Non-Federal Cost Sharing**

- a. For purposes of this Award, the Federal share is the amount of EDA funds invested under the Award, while the non-Federal share, or "Matching Share," means non-EDA funds and any in-kind contributions that are approved by EDA and provided by the Recipient or by third parties as a condition of the Award.
- b. By accepting the Award, the Recipient certifies that the Matching Share of Project costs is committed to the Project, available as needed, and not conditioned or encumbered in any way that precludes its use consistent with the requirements of the Award. See 13 CFR § 301.5 ("Matching share requirements").
- c. In the case of an overrun at the construction bid opening, the Recipient may augment the Matching Share by an amount sufficient to cover the excess cost. The Recipient must furnish a letter to EDA identifying the source of the additional funds and confirming that all Matching Share meets the requirements of 13 CFR § 301.5. See 13 CFR § 305.10 ("Bid underrun and overrun").

4. **Budget Revisions and Transfer of Funds**

- a. *Approved budget plan; notification of deviations.* The EDA-approved budget set forth in the specific award conditions or otherwise incorporated under the Award is the budget plan for the Project. The Recipient must notify EDA of deviations from the budget in accordance with 2 CFR § 200.308 ("Revision of budget and program plans"). If prior written approval is not required under 2 CFR § 200.308, the Recipient may request the Grants Officer's review of

and guidance on proposed revisions to the budget.

- b. *Requesting budget revisions.* Requests for budget revisions to the EDA-approved budget must be submitted through the Project Officer to the Grants Officer, who will make the final determination on such requests and notify the Recipient in writing.
- c. *Budget revisions that require an amendment.* In accordance with 2 CFR § 200.308(f) and (h), an amendment executed by the Grants Officer are required for budget revisions when:
 - i. The revision results from changes in the scope or the objective of the Project;
 - ii. The need arises for additional EDA funds to complete the Project;
 - iii. The Federal share exceeds the simplified acquisition threshold (currently set at \$250,000) and the cumulative amount of transfers among direct cost categories exceeds or is expected to exceed 10 percent of the total budget as last approved by EDA; and
 - iv. A revision is desired that involves specific costs for which prior written approval requirements may be imposed consistent with applicable cost principles listed in subpart E of 2 CFR part 200 (“Cost Principles”).
- d. *Prior approval for transfers between construction and non-construction items.* When an Award supports both construction and non-construction work, the Recipient must obtain prior written approval from the Grants Officer before making any fund or budget transfer from non-construction to construction or vice versa. *See* 2 CFR § 200.308(h)(5).
- e. *Project underrun amounts.* Underrun amounts will be transferred to the contingencies line item. Contingency funds are to be used to address situations resulting from unknown conditions and changes required for the fulfillment of authorized activities under this Award. EDA may approve the use of underrun funds to increase the Federal share of the Project or further improve the Project, as long as EDA determines that the use is consistent with the original purpose of the Award. *See* 13 CFR § 308.1 (“Use of funds in projects constructed under projected cost”).
- f. *Additional EDA funding in case of Project overrun amounts.* In accepting this Award, the Recipient agrees to fund any overrun amounts from non-Federal sources, or if the Recipient is unable or unwilling to do so, to request termination of the Award. Additional EDA assistance for the Project is at the discretion of EDA and may not be approved.

5. Indirect Costs and Facilities and Administrative Costs

- a. Indirect costs, or facilities and administrative (F&A) costs for educational institutions, are generally not applicable under this Award. See the definition of “indirect (facilities and administrative) (F&A) costs” at 2 CFR § 200.1.
- b. When indirect costs are applicable, they will not be allowable charges against the Award unless approved under the Award and specifically included as a line item in the Award’s approved budget. *See* section B.06 of the DOC Standard Terms and Conditions (“Indirect or Facilities and Administrative Costs”), which are incorporated into these EDA Construction STCs in Part III.

6. **Incurring Costs Prior to Award**

Project activities, including the procurement of good and services, which may include construction activities, carried out prior to EDA's approval of this Award are done at the sole risk of the Recipient and at the risk of not being reimbursed by EDA. Such activity may result in the rejection of the Application, the disallowance of costs, or other adverse consequences as a result of noncompliance with EDA or Federal requirements, including but not limited to procurement requirements, civil rights requirements, Federal labor standards, or environmental and historic preservation requirements. The Grants Officer must authorize pre-award costs and activities in writing, and such costs must also be allowable under relevant Federal cost principles and the specific Award terms and be included in the EDA-approved budget. Pre-award costs not included in the authorized budget are not allowable and will not be reimbursed. *See* 13 CFR § 302.8 ("Pre-approval Investment Assistance costs").

7. **Program Income**

For Projects that generate revenue (*e.g.*, rent for buildings or real property constructed or improved with EDA funds, rent or fees charged for use of equipment purchased with EDA funds, fees charged by the Recipient or a third party in connection with Project operations, etc.), the Recipient agrees, for the estimated useful life of the EDA-assisted facility or equipment, to use income generated from the facility or equipment, in the following order of priority unless modified by a specific award condition:

- a. Administration, operation, maintenance, and repair of Project facilities in a manner consistent with good property management practice and in accordance with established building codes. This includes, where applicable, repayment of indebtedness resulting from any EDA-approved encumbrance (*e.g.*, approved mortgage) on the EDA-assisted facility. In the case of equipment, administration, operation, maintenance, and repair of the equipment, or the facility in which the equipment is located as required to maintain and operate the equipment, for the equipment's estimated useful life.
- b. Economic development activities that are authorized for support by EDA, provided such activities meet the economic development purposes of PWEDA and are located within the designated Project region.
- c. Any program income in excess of paragraphs a. and b. of this section that is generated during the period of performance must be deducted from total allowable Project costs in accordance with 2 CFR § 200.307(e)(1). *See also* 2 CFR § 200.307 ("Program income").

8. **Information on Recipient integrity.** The Recipient agrees to provide EDA with information and documentation necessary for EDA to conduct due diligence to ensure the financial integrity and responsibility of the Recipient and key individuals associated with the Recipient in the management or administration of this Award.

B. **Programmatic Requirements**

1. **Project Progress and Performance Reporting**

- a. Project progress reports must be submitted in accordance with the procedures set out in 2 CFR § 200.329 ("Monitoring and reporting program performance"), as applicable, and as

indicated below. Failure to submit required reports in a complete, accurate, and timely manner may result in the withholding of payments under this Award; deferral of processing of new awards, amendments, or supplemental funding; or other appropriate enforcement action. *See* 13 CFR § 302.18 (“Post-approval requirements”) and section A.06 (Unsatisfactory Performance or Non-Compliance with Award Provisions) of the DOC Standard Terms and Conditions, which are incorporated in Part III of these EDA Construction STCs.

- b. Unless otherwise specified in a specific award condition, the Project progress report must contain the following information for each Project program, function, or activity:
 - i. A comparison of planned and actual accomplishments according to the timetable or list of Project objectives in this Award;
 - ii. An explanation of any delays or failures to meet the Project timetable or Project goals; and
 - iii. Any other pertinent information including, when appropriate, analysis and explanation of cost overruns or high unit costs.

Project progress reports must be submitted for each calendar quarter to the Project Officer. Each Project progress report must be submitted in accordance with the deadlines outlined in the specific award conditions, or, when not otherwise specified, Project progress reports will be due on a quarterly basis not later than January 31, April 30, July 31, and October 31 for the immediately previous quarter. The final Project progress report must be submitted to EDA no later than 120 calendar days after the end date of the period of performance. *See* Part II, section B.16.c “Project Closeout Procedures” of these EDA Construction STCs for more information on Project Closeout.

- c. The Recipient must submit quarterly Project progress reports to the EDA Project Officer electronically unless otherwise specified in the specific award conditions.

2. **Time Extensions**

- a. Unless otherwise authorized by a specific award condition, any extension of the period of performance can only be authorized by the Grants Officer in writing.
- b. The Recipient is responsible for implementing the Project in accordance with the development time schedule contained in this Award. As soon as the Recipient becomes aware that it may not be possible to meet the development time schedule, the Recipient must notify the Grants Officer. The Recipient’s notice to EDA must contain the following:
 - i. An explanation of the Recipient’s inability to complete work by the specified date (*e.g.*, a lengthy period of unusual weather delayed the contractor’s ability to excavate the site, major re-engineering required in order to obtain State or Federal approvals, unplanned environmental mitigation required);
 - ii. A statement describing any other contemplated changes to the Project;
 - iii. Documentation that demonstrates there is still a bona fide need for the Project; and
 - iv. A statement that no further delay is anticipated and that the Project can be completed within the revised time schedule.

EDA reserves the right to withhold disbursements while the Recipient is not in compliance with the time schedule and to suspend or terminate this Award if the Recipient fails to proceed with reasonable diligence to accomplish the Project as intended.

3. Interim Reporting of Significant Project Developments

The Recipient must promptly report any event that may have a significant impact upon the Project, including delays or adverse conditions that may materially affect the ability of the Recipient to attain Project objectives within established time periods or meet the development time schedule without waiting for the next quarterly progress report. The Recipient should report such events to the Project Officer in the most time-expedient way possible and then, if the initial report was not in writing, report the event to the Project Officer in writing. Such a report must include a statement of the event or issue, a statement of the course of action taken or contemplated to resolve the matter, and any Federal assistance needed to resolve the situation. If budget changes are required, the Recipient must submit a written budget revision request. *See* 2 CFR § 200.329(e) (“Monitoring and reporting program performance”) and Part II, section A.4. “Budget Revisions and Transfers of Funds” of these EDA Construction STCs.

4. Programmatic Changes

- a. In accordance with 2 CFR § 200.308 (“Revision of budget and program plans”), the Recipient must submit a written request for any proposed programmatic changes, including all changes to the scope of the Award, to the Project Officer. *See* Part II, section A.4 “Budget Revisions and Transfers of Funds” of these EDA Construction STCs for budget revisions that may require the prior written approval of EDA. In these cases, the Project Officer will forward the request to the Grants Officer, who makes the final decision on approving the request. In addition, the Recipient must request prior written approvals for certain items of cost in accordance with 2 CFR § 200.407 (“Prior written approval (prior approval)”).
- b. Any changes made to the Project without EDA’s approval are made at the Recipient’s own risk, and may result in disallowance of costs, suspension, termination, or other EDA action with respect to the Award. *See* 13 CFR § 302.7(b) (“Amendments and changes”).
- c. *Contract Change Orders.* After construction contracts for the Project have been executed, it may become necessary to alter them through a formal contract change order that must be issued by the Recipient and accepted by the contractor. All contract change orders must be reviewed by EDA, even if EDA is not participating in the cost of the change order or the contract price is to be reduced. Work on the Project may continue pending EDA review and approval of the change order, but all such work will be at the Recipient’s risk as to whether the cost of the work is eligible for EDA reimbursement. *See* 13 CFR § 305.13 (“Contract change orders”).

5. Government Performance and Results Act

In addition to quarterly Project progress reports, EDA may require the Recipient to report on Project performance beyond the end date of the period of performance for Government Performance and Results Act (GPRA) or other purposes. In no case will the Recipient be required to submit any GPRA report more than ten years after the date of Award closeout. Data used by the Recipient in preparing reports must be accurate and, whenever possible, from independent sources. *See* 13 CFR § 302.16 (“Accountability”).

6. Beneficiary Compliance

In the event a beneficiary of the Project fails to comply in any manner with certifications, assurances, or agreements that such beneficiary has entered into in accordance with EDA's requirements, the Recipient will reimburse EDA the Award amount or an amount to be determined by the EDA pursuant to 13 CFR §§ 314.4 ("Unauthorized use of property") and 314.5 ("Federal share"). When EDA determines that the failure of a beneficiary to comply with EDA requirements affects a portion of the property benefited by the Award, the Recipient will reimburse EDA proportionately.

7. Hold Harmless

To the maximum extent permitted by law, the Recipient agrees to indemnify and hold the United States harmless from and against all liabilities that the United States may incur due to the actions or omissions of the Recipient, including to the extent that such liabilities are incurred because of toxic or hazardous contamination or groundwater, surface water, soil, or other conditions caused by actions of the Recipient or any of its predecessors (other than the United States or its agents) on the property. *See* 13 CFR § 302.19 ("Indemnification").

8. Prohibition on Use of Third Parties to Secure Award

Unless otherwise specified in the application materials supporting this Award, the Recipient warrants that no person or selling agency has been employed or retained to solicit or secure this Award upon an agreement or understanding for a commission, percentage, brokerage, or contingent fee, excepting bona fide employees, or bona fide established commercial or selling agencies maintained by the Recipient for the purpose of securing business. For breach or violation of this warranty, EDA has the right to terminate this Award for material noncompliance, or at its discretion, to deduct from the Award amount, or otherwise recover, the full amount of such commission, percentage, brokerage, or contingent fee.

9. Payment of Attorneys' or Consultants' Fees

No Award funds may be used, directly or indirectly, to reimburse attorneys' or consultants' fees incurred in connection with obtaining an award under PWEDA, such as, for example, preparing an application for EDA assistance. However, ordinary and reasonable attorneys' and consultants' fees incurred for meeting Award requirements (*e.g.*, conducting a title search or preparing plans and specifications) may be eligible Project costs and may be paid out of Award funds, provided such costs are otherwise eligible. *See* 13 CFR § 302.10 ("Attorneys' and consultants' fees, employment of expeditors, and post-employment restriction").

10. Recipient's Duty to Refrain from Employing Certain Government Employees

- a. Pursuant to section 606(2) of PWEDA (42 U.S.C. § 3216), for the two-year period beginning on the date EDA executes this Award, any Recipient that is a nonprofit organization, District Organization, or for-profit entity agrees that it will not employ, offer any office or employment to, or retain for professional services any person who:
 - i. On the date EDA executes this Award or within the one-year period ending on that date, served as an officer, attorney, agent, or employee of the Department, and
 - ii. Occupied a position or engaged in activities that the Assistant Secretary determines

involved discretion with respect to the funding of an Award.

- b. In addition to the types of Recipients noted in paragraph a. above, EDA may require another Eligible Applicant to execute an agreement to abide by the above-described post-employment restriction on a case-by-case basis—for example, when an institution of higher education implements activities under or related to the Award through a separate nonprofit organization or association.
- c. The two-year period and associated restrictions referenced above also will apply beginning on the date that EDA executes any cost amendment to this Award that provides additional funds to the Recipient.

See also 13 CFR § 302.10 (“Attorneys’ and consultants’ fees, employment of expeditors, and post-employment restriction”).

11. Commencement of Construction

- a. *Delayed construction starts.* If significant construction (as determined by EDA) is not commenced within two years of the Award date or by the date estimated for start of construction in this Award (or the expiration of any extension granted in writing by EDA), whichever is later, this Award will be automatically suspended by a written notification issued by the Grants Officer and may be terminated if EDA determines, after consultation with the Recipient, that construction to completion cannot reasonably be expected to proceed promptly and expeditiously.
- b. *Early construction starts.* The Recipient must make a written request to EDA for early construction start permission (that is, after the date of Award, but before EDA gives formal approval for construction to commence). Costs incurred under a contract are only allowable after EDA determines that the award of the contract is in compliance with all terms and conditions of the Award. If construction commences prior to EDA’s determination, the Recipient proceeds at its own risk until EDA’s review and concurrence. *See* 13 CFR § 305.11 (“Contract awards; early construction start”).

12. Project Sign and Use of EDA Logo

- a. *Project sign.* The Recipient is responsible for constructing, erecting, and maintaining in good condition throughout the construction period a sign (or signs) in a conspicuous place at the Project site indicating that the Federal Government is participating in the Project. EDA will provide specifications for the sign and may require more than one sign if site conditions so warrant. If the EDA-recommended sign specifications conflict with State or local law, the Recipient may modify such recommended specifications so as to comply with State or local law. *See* 13 CFR § 305.12 (“Project sign”).
- b. *Use of EDA logo.* With EDA’s prior written permission, the Recipient may use the EDA logo to publicize the Award as well as to amplify the impact of the Award. In such cases, the EDA logo may be displayed on Award-related materials that discuss or advertise the purpose or use of the Project (e.g. websites, social media, fliers, pamphlets, brochures). To seek permission to use the EDA logo, the Recipient must contact the EDA Project Officer and provide a written description of how the Recipient proposes to use the EDA logo. In general,

the EDA logo may be used either alone or next to Recipient's logo. The EDA logo may not be used to endorse a third party as interpreted at EDA's sole discretion. The Recipient must not use the EDA logo in a negative or defamatory manner, and the Recipient must not use the U.S. Department of Commerce (DOC) logo. EDA may rescind such permission at any time.

13. Efficient Administration of Project

The Recipient agrees to properly and efficiently administer, operate, and maintain the Project for its estimated useful life, as required by section 504 of PWEDA (42 U.S.C. § 3194). If EDA determines at any time during the estimated useful life of the facility that the Project is not being properly and efficiently administered, operated, and maintained, EDA may terminate this Award (if it is still active) and/or may take appropriate enforcement action to protect the Federal Interest in the Project, including requiring the Recipient to repay the Federal Share. *See* 13 CFR §§ 302.12 ("Project administration, operation and maintenance"), 302.18 ("Post-approval requirements"), and 314.2 ("Federal Interest") through 314.5 ("Federal Share").

14. Conflicts-of-Interest Rules

- a. An "Interested Party" is defined in 13 CFR § 300.3 ("Definitions") as "any officer, employee, or member of the board of directors or other governing board of the Recipient, including any other parties that advise, approve, recommend, or otherwise participate in the business decisions of the Recipient, such as agents, advisors, consultants, attorneys, accountants, or shareholders." An Interested Party includes the Interested Party's Immediate Family and other persons directly connected to the Interested Party by law or through a business organization. "Immediate Family" is defined in 13 CFR § 300.3 as "a person's spouse (or domestic partner or significant other), parents, grandparents, siblings, children and grandchildren, but does not include distant relatives, such as cousins, unless the distant relative lives in the same household as the person."
- b. The Recipient must disclose in writing any potential conflicts of interest to EDA or the pass-through entity as soon as practicable after the identification of such potential conflict. In addition, the Recipient must maintain written standards of conduct to establish safeguards to prohibit an Interested Party from using its position for a purpose that constitutes or presents the appearance of personal or organizational conflicts-of-interest or of personal gain in the administration of an award. *See* 13 CFR § 302.17(a) and (b) ("Conflicts of interest"), 2 CFR § 200.112 ("Conflict of interest"), as applicable, and assurances submitted as part of the Application, including assurances submitted through SAM.gov or via Form SF-424D ("Assurances – Construction Projects").
- c. An Interested Party must not receive any direct or indirect financial or personal benefit in connection with this Award or its use for payment or reimbursement of costs by or to the Recipient. A conflict of interest generally exists when an Interested Party participates in a matter that has a direct and predictable effect on the Interested Party's personal or financial interests. A conflict also may exist where there is an appearance that an Interested Party's objectivity in performing his or her responsibilities under the Project is impaired. For example, an appearance of impairment of objectivity may result from an organizational conflict where, because of other activities or relationships with other persons or entities, an Interested Party is unable to render impartial assistance, services or advice to the Recipient, a participant in the Project or to the Federal government. Additionally, a conflict of interest

may result from non-financial gain to an Interested Party, such as benefit to reputation or prestige in a professional field. *See* 13 CFR § 302.17(a) and (b).

- d. Section F.01.c of the DOC Standard Terms and Conditions, which are incorporated as Part III of these EDA Construction STCs, specifies procurement-related conflicts of interest requirements. *See also* 2 CFR §§ 200.317-200.327 (“Procurement Standards”).

15. Records-Keeping Requirements

- a. *Records.* The Recipient must maintain records that document compliance with the terms and conditions of this Award. At a minimum, the Recipient’s records must fully disclose:
 - i. The amount and disposition of all EDA funding under the Award;
 - ii. All Project expenditures and procurement actions;
 - iii. The total cost of the Project that the Award funds;
 - iv. Copies of all reports and disbursement requests submitted to EDA;
 - v. The benefits/impacts of the Project, as reported through GPRA and other reports to EDA;
 - vi. The amount and nature of the portion of Project costs provided by non-EDA sources;
 - vii. Contractor compliance with applicable Federal requirements; and
 - viii. Such other records as EDA requires the Recipient to maintain, including such records as will facilitate an effective audit.
- b. *Records retention.* In general, and in accordance with 2 CFR § 200.334 (“Retention requirements for records”), all records pertinent to this Award must be retained for a period of three years from the date of submission of the final Project expenditure report (the final Form SF-271 for disbursement). The only exceptions are the following:
 - i. If any litigation, claim, or audit is started before the expiration of the three-year period, the records must be retained until all litigation, claims, or audit findings involving the records have been resolved and final actions taken.
 - ii. When the Recipient is notified in writing by EDA, its cognizant agency for either audit or indirect costs, its oversight agency for audit, or the relevant pass-through entity to extend the retention period, it must retain the records as directed.
 - iii. Records for real property and equipment acquired with Federal funds must be retained for three years after final disposition of the relevant real property or equipment.
 - iv. When records are transferred to or maintained by EDA or pass-through entity, the three-year retention requirement is not applicable to the Recipient.
 - v. *Records for program income transactions after the period of performance.* In some cases, Recipients must report program income after the period of performance. Where there is such a requirement, the retention period for the records pertaining to the earning of the program income starts from the end of the Recipient’s fiscal year in which the program income is earned. *See also* Part II, section A.7 “Program Income” of these EDA Construction STCs.

- vi. *Indirect cost rate proposals and cost allocation plans.* This paragraph applies to the following types of documents and their supporting records: indirect cost rate computations or proposals, cost allocation plans, and any similar accounting computations of the rate at which a particular group of costs is chargeable (such as computer usage chargeback rates or composite fringe benefit rates).
 - (1) *If submitted for negotiation.* If the proposal, plan, or other computation is required to be submitted to the Federal Government (or to the pass-through entity) to form the basis for negotiation of the rate, then the three-year retention period for its supporting records starts from the date of such submission.
 - (2) *If not submitted for negotiation.* If the proposal, plan, or other computation is not required to be submitted to the Federal Government (or to the pass-through entity) for negotiation purposes, then the three-year retention period for the proposal, plan, or computation and its supporting records starts from the end of the fiscal year (or other accounting period) covered by the proposal, plan, or other computation.
- c. **Monitoring and reporting obligations.** The Recipient is responsible for monitoring any subrecipients and contractors to ensure their compliance with the records retention requirements. The Recipient must immediately notify the Project Officer if records are lost. *See* 2 CFR §§ 200.331 – 200.333 (“Subrecipient Monitoring and Management”).

16. Termination Actions

- a. In accordance with 2 CFR § 200.340 (“Termination”), this Award may be terminated in whole or in part as follows:
 - i. *Termination by EDA for the Recipient’s failure to comply with the terms and conditions of the Award.* EDA may terminate this Award, in whole or in part, if the Recipient fails to comply with the Terms and Conditions of the Award, including but not limited to:
 - (1) Any representation made by the Recipient to the Federal awarding agency in connection with the Application for Federal assistance is incorrect or incomplete in any material respect;
 - (2) The Project has changed substantially, without EDA prior approval, so as to affect significantly the accomplishment of the Project as intended (including an unauthorized use of property as provided in 13 CFR § 314.4 (“Unauthorized use of property”));
 - (3) The Recipient has violated commitments it made in its Application and supporting documents or has violated any of the Terms and Conditions of the Award;
 - (4) The conflicts-of-interest rules at 13 CFR § 302.17 (“Conflicts of interest”) are violated; or
 - (5) The Recipient fails to report immediately to EDA any change of authorized representative acting in lieu of or on behalf of the Recipient.

See also section A.06 (Unsatisfactory Performance or Non-Compliance with Award Provisions) of the DOC Standard Terms and Conditions, which are incorporated in Part III of these EDA Construction STCs.

- ii. *Termination by EDA when the Award no longer effectuates program goals or agency priorities.* To the greatest extent authorized by law, EDA may terminate this Award if it no longer effectuates program goals or agency priorities.
 - iii. *Termination by the Recipient.* The Recipient may terminate this Award in whole or in part upon by sending the EDA Grants Officer written notification setting forth the reasons for such termination, the effective date, and, in the case of partial termination, the portion to be terminated. However, if EDA determines in the case of partial termination that the reduced or modified portion of the EDA Award will not accomplish the purposes for which the EDA Award was made, EDA may terminate the Award in its entirety.
 - iv. *Termination pursuant to Award termination provisions.* EDA or the pass-through entity may terminate this Award pursuant to termination provisions included in the Award. Any Award-specific termination provision will be included as a specific award condition.
 - v. *Termination upon mutual agreement.* EDA and the Recipient may mutually agree to terminate this Award in whole or in part. In such cases, EDA and the Recipient must agree upon the termination conditions, including the effective date and, in the case of partial termination, the portion to be terminated.
- b. If the Award is wholly or partially terminated, the Recipient remains responsible for compliance with the requirements in 2 CFR §§ 200.344 (“Closeout”) and 200.345 (“Post-closeout adjustments and continuing responsibilities”).

17. Project Closeout Procedures

- a. *Project Closeout.* As defined at 2 CFR § 200.1, Project Closeout means the process by which EDA determines that all applicable administrative actions and all required work of the Award have been completed and takes actions as described at 2 CFR § 200.344 (“Closeout”). In the context of an EDA construction award, Project Closeout generally begins with the Recipient’s acceptance of the Project from the contractor(s).
- b. *Final disbursement.* When Project construction and final inspection have been completed, or substantially completed as determined by EDA, and the Recipient has accepted the Project from the contractor(s), the Recipient can begin the Closeout process by submitting the following documentation to EDA:
 - i. A request for final disbursement on an executed Form SF-271;
 - ii. A written certification that all costs charged against this Award (Federal and non-Federal shares) are for eligible activities and represent allowable costs, for which there is documentation in the Recipient’s records;
 - iii. An executed certificate of final acceptance signed by the Recipient and the Recipient’s architect/engineer;
 - iv. The Recipient’s certification that its current audit (in accordance with subpart F of 2 CFR part 200), if applicable, has been submitted to the Federal Audit Clearinghouse;

- v. The Recipient's certification that its currently valid single or program-specific audit in accordance with subpart F of 2 CFR part 200 ("Audit Requirements"), if applicable, does not contain any material findings (if the Recipient's currently valid audit does contain material findings, the Recipient must submit the applicable audit preferably via e-mail to the Project Officer, who will review with the Grants Officer); and
- vi. Other documentation as may be required by EDA.

EDA will advise the Recipient of costs determined to be allowable and unallowable. If a balance of this Award is due to the Recipient, the balance will be paid by EDA. If the Recipient has received an amount in excess of the amount due the Recipient, the Recipient must refund the excess to EDA. The Recipient must contact the Project Officer for refund instructions.

As noted above, if the Recipient's most recent audit completed pursuant to subpart F of 2 CFR part 200 contains material findings, the Recipient must submit the audit, preferably via e-mail, to the Project Officer, who will review with the Grants Officer before final disbursement. If e-mail is unavailable, the Recipient may submit a hardcopy version of the audit to the Project Officer.

- c. *Final reporting deadline.* The Recipient must submit, no later than 120 calendar days after the end date of the period of performance, all financial, performance, and other reports as required by the Terms and Conditions of this Award. The Grants Officer may extend the 120 calendar day submission period upon a written request from the Recipient.
- d. *Deadline to liquidate obligations.* Unless EDA authorizes an extension, the Recipient must liquidate all financial obligations incurred under this Award no later than 120 calendar days after the end date of the period of performance.
- e. *Post-Closeout requirements.* As noted above in section B.12 "Efficient Administration of Project" of these EDA Construction STCs, after construction is completed and the Project is closed out financially, the Recipient has an ongoing responsibility to properly administer, operate, and maintain the Project for its estimated useful life (as determined by EDA) in accordance with Award purposes. *See* 13 CFR § 302.12 ("Project administration, operation and maintenance"). The Recipient must comply with all Award requirements and maintain records to document such compliance, which must be made available for inspection by EDA or other Government officials as required.

In addition, in accordance with 2 CFR § 200.345 "Post-closeout adjustments and continuing responsibilities," the Closeout of this Award does not affect any of the following:

- i. The right of EDA to disallow costs and recover funds on the basis of a later audit or other Project review;
- ii. The Recipient's obligation to return any funds due as a result of later corrections or other transactions;
- iii. Audit requirements per subpart F of 2 CFR part 200; and
- iv. Requirements for property management and disposition, records retention, and

performance measurement reports. *See* subpart D of 2 CFR part 200 (“Post Federal Award Requirements”), as applicable.

- f. *GPRA reporting.* As required under GPRA and in accordance with a schedule that will be provided by EDA, the Recipient must submit additional Performance Measurement Reports, generally three, six, and nine years after the date of the Award to accurately and completely report the impacts of the Project, especially in terms of job creation and private investment leveraging.

18. Freedom of Information Act

EDA is responsible for meeting its Freedom of Information Act (“FOIA”) (5 U.S.C. § 552) responsibilities for its records. DOC regulations at 15 CFR part 4 set forth the requirements and procedures that EDA must follow in order to make the requested material, information, and records publicly available. Unless prohibited by law and to the extent required under the FOIA, contents of Applications and other information submitted by applicants and Recipients may be released in response to a FOIA request. The Recipient should be aware that EDA may make certain Application and other submitted information publicly available. Accordingly, as set forth in 15 CFR § 4.9 (“Confidential commercial information”), the Recipient should identify in its Application any “business information” it believes to be protected from disclosure pursuant to 5 U.S.C. § 552(b)(4).

C. Additional Requirements Related to Construction Projects

The Recipient and any subrecipients, must, in addition to other statutory and regulatory requirements detailed in these EDA Construction STCs and the assurances made to EDA in connection with the Award, comply and require each of its contractors and subcontractors employed in the completion of the Project to comply with all applicable Federal, State, territorial, and local laws, and in particular, the following Federal laws (and the regulations issued thereunder), executive orders, OMB circulars, OMB Uniform Guidance, and local law requirements.

1. **The Davis-Bacon Act, as amended (40 U.S.C. §§ 3141–3144, 3146, 3147; 42 U.S.C. § 3212)**, which requires minimum wages for mechanics and laborers employed on Federal Government public works projects to be based on the wages that the Secretary of Labor determines to be prevailing for the corresponding classes of laborers and mechanics employed on projects of a character similar to the contract work in the civil subdivision of the State in which the Project is to be performed, or in the District of Columbia if the Project is to be performed there.
2. **The Contract Work Hours and Safety Standards Act, as amended (40 U.S.C. §§ 3701-3708)**, which provides work hour standards for every laborer and mechanic employed by any contractor or subcontractor in the performance of a Federal public works project.
3. **The National Historic Preservation Act of 1966, as amended (54 U.S.C. § 300101 *et seq.*), and the Advisory Council on Historic Preservation Guidelines (36 CFR part 800)**, which require stewardship of historic properties in projects involving Federal funds.
4. **Preservation of Historical and Archeological Data (54 U.S.C. § 312502)**, which requires appropriate surveys and preservation efforts if a Federally licensed project may cause

irreparable loss or destruction of significant scientific, prehistorical, historical, or archeological data.

5. **The Architectural Barriers Act of 1968, as amended (42 U.S.C. § 4151 *et seq.*)**, and the regulations issued thereunder, which prescribe standards for the design and construction of any building or facility intended to be accessible to the public or that may house handicapped employees.
6. **The Uniform Relocation Assistance and Real Property Acquisition Policies Act of 1970, as amended (42 U.S.C. § 4601 *et seq.*)**, and implementing regulations issued at 49 CFR part 24 (“Uniform Relocation Assistance and Real Property Acquisition for Federal and Federally Assisted Programs”), which establish uniform policies for the fair and equitable treatment of persons, businesses, or farm operations affected by the acquisition, rehabilitation, or demolition of real property acquired for a project financed wholly or in part with Federal financial assistance.
7. **The Energy Conservation and Production Act (42 U.S.C. § 6834 *et seq.*)**, which establishes energy efficiency performance standards for the construction of new residential and commercial structures undertaken with Federal financial assistance.
8. **Executive Order 13717, “Seismic Safety of Federal and Federally Assisted or Regulated New Building Construction”**, which requires that new buildings constructed with Federal assistance comply with the earthquake-resistant design provisions of the 2015 editions of the International Building Code (IBC) or the International Residential Code (IRC), nationally recognized building codes promulgated by the International Code Council (ICC), or equivalent codes, consistent with the provisions of and to the extent required by 40 U.S.C. § 3312.
9. **Compliance with Local Construction Requirements.** The Recipient will comply with current local building codes, standards, and other requirements applicable to the Project.

D. **Non-Discrimination Requirements**

No person in the United States shall, on the ground of race, color, national origin, handicap, age, religion, or sex, be excluded from participation in, be denied the benefits of, or be subject to discrimination under any program or activity receiving Federal financial assistance. In addition to the non-discrimination requirements set forth in section G.02 “Non-Discrimination Requirements” of the DOC Standard Terms and Conditions, which are incorporated in Part III of these Construction STCs, the Recipient agrees to comply with Pub. L. No. 92-65, 42 U.S.C. § 3123, which proscribes discrimination on the basis of sex in assistance provided under PWEDA.

E. **Audits**

1. **General**

- a. Recipients must comply with the audit requirements set out as subpart F to 2 CFR part 200 (“Audit Requirements”). Generally, if the Recipient expends \$750,000 or more in Federal awards during the Recipient’s fiscal year, the Recipient must have a single or program-specific audit conducted for that fiscal year. The cost of preparing the audit may be

included in the Project budget.

- b. For program specific audits, EDA’s Public Works and Economic Adjustment Assistance programs generally have specific audit guidelines that will be incorporated into the Award and may be found in the annual Compliance Supplement, which is Appendix XI to 2 CFR part 200 and available on OMB’s website. When DOC does not have a program-specific audit guide available for the program, the auditor will follow the requirements for a program-specific audit as described in 2 CFR § 200.507 (“Program-specific audits”).

2. Requirement to Submit a Copy of the Audit to EDA

If the Recipient’s current audit required under subpart F of 2 CFR part 200 (“Audit Requirements”) contains material findings, the Recipient must submit a copy of the audit to the Project Officer, who will review it with the Grants Officer. *See also* Part II, section B.16 “Project Closeout Procedures” of these EDA Construction STCs.

See section D “Audits” of the DOC Standard Terms and Conditions, which are incorporated in Part III of these EDA Construction STCs, for additional information related to audit requirements.

F. Tribal Employment Rights Ordinances

As set out in 31 U.S.C. § 1352, special provisions are applicable to Indian Tribes, Tribal organizations, and other Indian organizations eligible to receive Federal contracts, grants, loans, or cooperative agreements. In accordance with DOC policy, EDA recognizes Tribal Employment Rights Ordinances (“TEROs”), which may provide for preferences in contracting and employment, in connection with its financial assistance awards. Federal awards granted to American Indian and Alaska Native Tribal governments generally may provide for preference to qualified Indians in all aspects of employment, contracting, and other business activities, as well as the payment of a TERO fee. The payment of the TERO fee, which supports the Tribal employment rights office to administer the preferences, should generally be allowable as an expense that is “necessary and reasonable for the performance of the Federal award,” as provided under 2 CFR § 200.403 (“Factors affecting allowability of costs”).

G. EDA Contracting Provisions for Construction Projects

The Recipient must use the “*EDA Contracting Provisions for Construction Projects*” as guidance in developing all construction contracts. The “*EDA Contracting Provisions for Construction Projects*” lists applicable EDA and other Federal requirements for construction contracts.

H. Property

1. Standards

With respect to any property acquired or improved in whole or in part with Award funds, the Recipient must comply with the Property Standards set forth at 2 CFR §§ 200.310 (“Insurance coverage”) through 200.316 (“Property trust relationship”), and EDA’s regulations at 13 CFR part 314. Property acquired or improved in whole or in part by the Recipient under this Award may consist of real property; personal property, including equipment and supplies; and intangible property, such as money, notes, contractual rights, and security interests. Any property reports required under 2 CFR §§ 200.310 through 200.316, such as periodic inventories and requests for disposition instructions, must be submitted to the Grants Officer through the Project Officer on

Form SF-428 and/or SF-429, as applicable. *See also* section A.01.d “Real Property, Tangible Property and Intangible Property Reports and Requests for Dispositions” of the DOC Standard Terms and Conditions, which are incorporated in Part III of these EDA Construction STCs.

2. Title

- a. Title to equipment, supplies, and intangible property acquired in whole or in part under this Award generally vests upon acquisition in the Recipient. The use, management and disposition of equipment, supplies, and intangible property acquired in whole or in part under this Award must be in accordance with 2 CFR §§ 200.313 (“Equipment”), 200.314 (“Supplies”), and 200.315 (“Intangible property”), as applicable, and EDA regulations at 13 CFR part 314. *See also* section C.03 “Intellectual Property Rights” of the DOC Standard Terms and Conditions, which are incorporated in Part III of these EDA Construction STCs.
- b. Title to real property acquired in whole or in part under this Award generally vests upon acquisition in the Recipient, subject to the condition that the Recipient uses the real property for the authorized purpose of the Project. *See* 2 CFR § 200.311 (“Real property”) and EDA regulations at 13 CFR part 314.

3. EDA’s Interest in Award Property

- a. *General - evidence of title.* As stated in Part I, section E, of these EDA Construction STCs “Recipient as Trustee”, real property, equipment, and intangible property acquired or improved under this Award must be held in trust by the Recipient as trustee for the public purposes of an Award. This trust relationship exists throughout the duration of the property’s estimated useful life, as determined by EDA, during which time EDA retains an undivided, equitable reversionary interest in the property (“Federal Interest”). *See* 13 CFR § 314.2.

Before advertising for construction bids or at such other time as EDA requires, the Recipient must furnish evidence, satisfactory in form and substance to EDA, that title to real property required for the Project (other than property of the United States and as provided in 13 CFR § 314.7(c) (“Title”)) is vested in the Recipient and that such easements, rights-of-way, State or local government occupancy or use permits, long-term leases, or other property interests or access rights required for the Project have been or will be obtained by the Recipient within an acceptable time, as determined by EDA. All liens, mortgages, other encumbrances, reservations, reversionary interests, or other restrictions on title or the Recipient’s interest in the property must be disclosed to EDA. *See* 13 CFR § 314.7 (“Title”). With limited exceptions set forth at 13 CFR §§ 314.6(a) and (b) (“Encumbrances”) or as otherwise authorized by EDA, Recipient-owned property acquired or improved in whole or in part with Award funds must not be used to secure a mortgage or deed of trust or in any way otherwise encumbered. *See* 13 CFR § 314.6.

b. Recording EDA’s Interest in Real Property.

- i. For all Projects involving the acquisition, construction, or improvement of a building, infrastructure, or other real property, as determined by EDA, the Recipient must execute and furnish to EDA, prior to initial Award disbursement or at such other time as EDA requires, a lien, covenant, or other statement, satisfactory to EDA in form and substance, of EDA’s interest in the property acquired or improved in whole or in part with the funds made available under this Award. EDA may permit such statement to be recorded after

- initial Award disbursement in the event that grant funds are being used to acquire such property or for authorized costs, such as design and engineering services. The statement must specify the estimated useful life of the Project and must include the disposition, encumbrance, and the Federal Share compensation requirements, as well as any other requirements specified by EDA in its reasonable discretion. *See* 13 CFR §§ 314.1 (“Definitions”) and 314.8(a) (“Recorded statement for real property”). *See also* 2 CFR § 200.316 (“Property trust relationship”).
- ii. This lien, covenant, or other statement of the Federal interest must be perfected and placed of record in the real property records of the jurisdiction in which the property is located, all in accordance with applicable law. EDA may require an opinion of counsel for the Recipient to substantiate that the document was validly executed and properly recorded. *See* 13 CFR § 314.8(b).
 - iii. Facilities in which the EDA assistance is only a small part of a larger project, as determined by EDA, may be exempted from the requirements listed in paragraphs H.3.b.i and ii above. *See* 13 CFR § 314.8(c).
 - iv. In extraordinary circumstances and at EDA’s discretion, EDA may choose to accept another instrument to protect EDA’s interest in the Project property, such as an escrow agreement or letter of credit, provided that EDA determines such instrument is adequate and a recorded statement in accord with section H.3.b.i above is not reasonably available. The terms and provisions of the relevant instrument must be satisfactory to EDA. The costs and fees for escrow services or letters of credit must be paid by the Recipient. *See* 13 CFR § 314.8(d).
- c. *Recording EDA’s Interest in Personal Property.* For all Projects involving the acquisition or improvement of significant items of equipment or other tangible personal property, including but not limited to watercraft, motor vehicles, machinery, equipment, removable fixtures, or structural components of buildings, the Recipient must execute a security interest, covenant, or other statement of EDA’s reversionary interest in the personal property acceptable in form and substance to EDA, which statement must be perfected and placed of record in accordance with applicable law (usually accomplished by filing a Uniform Commercial Code Financing Statement (Form UCC-1), as provided by State law), with continuances re-filed as appropriate. EDA may require an opinion of counsel for the Recipient to substantiate that the Form UCC-1 or other filing was validly executed and properly recorded. *See* 13 CFR § 314.9 (“Recorded statement for Project personal property”).
- d. *EDA’s Interest and the estimated useful life.* The Recipient acknowledges that EDA retains an undivided equitable reversionary interest in property acquired or improved in whole or in part with grant funds made available through this Award throughout the estimated useful life (as determined by EDA) of the Project, except in applicable instances set forth at 13 CFR § 314.7(c) (“Title”). *See* 13 CFR § 314.2(a) (“Federal interest”).
- e. *Unauthorized Use of Award Property.* The Recipient agrees that if any interest in property acquired or improved in whole or in part with Award funds is disposed of, encumbered, or alienated in any manner, or no longer used for the authorized purposes of the Award during the Project’s estimated useful life without EDA’s written approval, EDA will be entitled to recover the Federal Share, as defined at 13 CFR § 314.5 (“Federal share”). Examples of

alienation of Award property include sale or other conveyance of the Recipient's interest, leasing or mortgaging the property, or granting an option for any of the foregoing.

If, during the Project's estimated useful life, the property is no longer needed for the purposes of the Award, as determined by EDA, EDA may permit its use for other acceptable purposes consistent with those authorized by PWEDA and 13 CFR Chapter III. *See* 13 CFR § 314.3(b) ("Authorized use of property") or may direct the Recipient to sell the property and remit the Federal Share of the sales proceeds to EDA. *See* 2 C.F.R. §§ 200.311, 200.313.

- f. *Calculating the Federal Share.* For purposes of any lien or security interest, the amount of the Federal Share is the portion of the current fair market value of any property (after deducting any actual and reasonable selling and repair expenses incurred to put the property into marketable condition) attributable to EDA's participation in the Project. *See* 13 CFR § 314.5 ("Federal share").

4. **Insurance and Bonding**

- a. *Insurance.* The Recipient must, at a minimum, provide the equivalent insurance coverage for real property and equipment acquired or improved with Federal funds as provided for property owned by the Recipient. Federally owned property need not be otherwise insured unless required by the Terms and Conditions of the Award. *See* 2 CFR § 200.310 ("Insurance coverage").
- b. *Bonding.* If the Award exceeds the simplified acquisition threshold as defined at 2 CFR § 200.1, EDA may accept the Recipient's or subrecipient's bonding policy and requirements if EDA or the pass-through entity determines that the Federal Interest is adequately protected. If not, the following minimum requirements will apply:
 - i. A bid guarantee from each bidder equivalent to five percent of the bid price. The "bid guarantee" must consist of a firm commitment such as a bid bond, certified check, or other negotiable instrument accompanying a bid as assurance that the bidder will, upon acceptance of the bid, execute such contractual documents as may be required within the time specified.
 - ii. A performance bond on the part of the contractor for 100 percent of the contract price. A "performance bond" is one executed in connection with a contract to secure fulfillment of all the contractor's obligations under such contract.
 - iii. A payment bond on the part of the contractor for 100 percent of the contract price. A "payment bond" is one executed in connection with a contract to ensure payment as required by law of all persons supplying labor and material in the execution of the work provided for in the contract. *See* 2 CFR § 200.326 ("Bonding requirements").

5. **Leasing Restrictions.**

Leasing or renting of facilities or property is prohibited unless specifically authorized by EDA. The Recipient agrees that any leasing or renting of any facilities or property involved in this Project will be subject to the following:

- a. That said lease arrangement is consistent with the authorized general and special purpose of

the Award;

- b. That said lease arrangement is for adequate consideration;
- c. That said lease arrangement is consistent with applicable EDA requirements concerning but not limited to nondiscrimination and environmental compliance; and
- d. That all revenue derived from said leasing arrangement shall be subject to Part II, section A.7 “Program Income” of these EDA Construction STCs.

6. **Eminent Domain**

The Recipient will use funds solely for the authorized purpose of the Project. Pursuant to Executive Order 13406, “Protecting the Property Rights of the American People,” the Recipient agrees:

- a. Not to exercise any power of eminent domain available to the Recipient (including the commencement of eminent domain proceedings) for use in connection with the Project for the purpose of advancing the economic interests of private parties; and
- b. Not to accept title to land, easements, or other interests in land acquired by the exercise of any power of eminent domain for use in connection with the Project for such purposes. The Recipient agrees that any use of the power of eminent domain to acquire land, easements, or interests in land, whether by the Recipient or any other entity that has the power of eminent domain, in connection with the Project without the prior written consent of EDA is an unauthorized use of the Project. If the Recipient puts the Project to an unauthorized use, the Recipient must compensate EDA for the Federal Share in accordance with 13 CFR §§ 314.4 (“Unauthorized use of property”) and 314.5 (“Federal share”), as the same may be amended from time to time.

7. **Disposal of Real Property**

- a. During the estimated useful life of the Project, if EDA and the Recipient determine that property acquired or improved in whole or in part with Award funds is no longer needed for the original purposes of this Award, EDA may, in its discretion, approve use of the property in other Federal grant programs or in programs that have purposes consistent with those authorized by PWEDA and 13 CFR chapter III. *See* 13 CFR § 314.3(b) (“Authorized use of property”).
- b. When property is not authorized for other uses as provided in section H.7.a above, EDA will provide disposition instructions to the Recipient, which may include directing the Recipient to sell the property and remit the Federal Share of the sales proceeds to EDA.

8. **Reporting on Property.**

- a. *Real Property status reports and requests for disposition.* In accordance with 2 CFR § 200.330 “Reporting on real property”, the Recipient must submit reports using Form SF-429 (Real Property Status Report), including appropriate attachments, at least annually on the status of real property in which EDA retains an interest, which generally includes real property acquired or improved under the award, unless such interest extends 15 years or longer. If EDA’s interest is for a period of 15 years or longer, unless otherwise specified in a specific award condition, the Recipient must submit an annual report for the

first three years of the award and thereafter submit a real property status report every five years. If the Recipient wishes to dispose of real property acquired or improved under an EDA award, the Recipient must request disposition instructions, including the submission of Form SF-429, with appropriate attachments, from the Grants Officer in accordance with 2 CFR 200.311(c).

- b. *Tangible Personal Property status reports and requests for dispositions.* The Recipient must submit periodic reports as specified in the terms of the Award using Form SF-428 (Tangible Personal Property Report), including appropriate attachments thereto, concerning tangible personal property that is Federally owned or tangible personal property in which EDA retains an interest. In addition, if the Recipient wishes to dispose of tangible personal property acquired or improved under an EDA award, the Recipient must request disposition instructions, including the submission of Form SF-428, with appropriate attachments, from the Grants Officer in accordance with 2 CFR 200.313(e).

See also section A.01.d of the DOC Standard Terms and Conditions, which are incorporated in Part III of these EDA Construction STCs.

I. **Environmental Requirements**

1. **General.** In addition to the environmental statutes, executive orders, and requirements set forth in section G.04 of the DOC Standard Terms and Conditions “Environmental Requirements,” which are incorporated in Part III of these EDA Construction STCs, the Recipient must comply with the following:
 - a. **Environmental Quality Improvement Act of 1970, as amended (42 U.S.C. §§ 4371-4375).** Federally supported public works facilities and activities that affect the environment must be implemented in compliance with policies established under existing law.
 - b. **The Lead-Based Paint Poisoning Prevention Act (42 U.S.C. § 4821 *et seq.*).** Use of lead-based paint in residential structures improved with Federal assistance is prohibited.
 - c. **The Farmland Protection Policy Act (7 U.S.C. §§ 4201–4209).** Projects are subject to review under this Act if they may irreversibly directly or indirectly convert farmland, including forest land, pastureland, cropland, or other land, to nonagricultural use.
 - d. **The Noise Control Act of 1972 (42 U.S.C. § 4901 *et seq.*).** Federally supported facilities and activities must comply with Federal, State, interstate, and local requirements respecting control and abatement of environmental noise to the same extent that any person is subject to such requirements.
 - e. **The Native American Graves Protection and Repatriation Act (25 U.S.C. § 3001 *et seq.*).** This Act provides a process for returning certain Native American cultural items to lineal descendants, culturally affiliated Indian tribes, and Native Hawaiian organizations.
2. **Compliance with Other Applicable Environmental Requirements**

The Recipient agrees to promptly notify the Grants Officer in writing of any environmental requirement or restriction, regulatory or otherwise, with which it must comply. Before Project Closeout and final disbursement of Award funds, the Recipient further agrees to provide evidence

satisfactory to the Grants Officer that any required environmental remediation has been completed: (1) in compliance with all applicable Federal, State and local regulations; and (2) in accordance with any legally enforceable restrictions related to environmental restriction on the property such as environmental easements, deed restrictions, no further action determinations, or voluntary cleanup certifications. Compliance with said laws or restrictions must be included in any contract documents for Project construction. The Recipient must certify compliance before final disbursement of grant funds.

J. American-Made Equipment and Products

Recipients are hereby notified that they are encouraged, to the greatest extent practicable, to purchase American-made equipment and products with funding provided under this Award.

See also section G.05.a (Buy-American Preferences) of the DOC Standard Terms and Conditions, which are incorporated in Part III of these EDA Construction STCs.

**PART III:
DEPARTMENT OF COMMERCE
STANDARD TERMS & CONDITIONS**

The DOC Standard Terms and Conditions dated November 12, 2020 are incorporated herein by reference herein as Part III of these EDA Construction STCs.

In the event of a conflict between Parts I or II of these EDA Construction STCs and Part III, which incorporates the DOC Standard Terms and Conditions, Parts I and II will control.

DEPARTMENT OF COMMERCE
FINANCIAL ASSISTANCE
STANDARD TERMS AND CONDITIONS



12 November 2020

DEPARTMENT OF COMMERCE
FINANCIAL ASSISTANCE STANDARD TERMS AND CONDITIONS

Table of Contents

PREFACE.....	5
A. PROGRAMMATIC REQUIREMENTS	6
.01 Reporting Requirements	6
.02 Revisions of Program Plans	8
.03 Other Federal Awards with Similar Programmatic Activities.....	9
.04 Prohibition against Assignment by a Non-Federal Entity	9
.05 Disclaimer Provisions	9
.06 Unsatisfactory Performance or Non-Compliance with Award Provisions	9
B. FINANCIAL REQUIREMENTS.....	10
.01 Financial Management.....	10
.02 Award Payments	10
.03 Federal and Non-Federal Sharing	12
.04 Budget Changes and Transfer of Funds among Categories.....	12
.05 Program Income.....	13
.06 Indirect or Facilities and Administrative Costs	13
.07 Incurring Costs or Obligating Federal Funds Before and After the Period of Performance	15
.08 Tax Refunds.....	16
.09 Internal Controls	16
C. PROPERTY STANDARDS.....	16
.01 Standards.....	16
.02 Real and Personal Property	16
.03 Intellectual Property Rights	17
D. AUDITS	19
.01 Organization-Wide, Program-Specific, and Project Audits.....	19
.02 Audit Resolution Process.....	20
E. DEBTS	21
.01 Payment of Debts Owed to the Federal Government	21
.02 Late Payment Charges	21
.03 Barring Delinquent Federal Debtors from Obtaining Federal Loans or Loan Insurance Guarantees.....	22

.04	Effect of Judgment Lien on Eligibility for Federal Grants, Loans, or Programs.....	22
F.	CONFLICT OF INTEREST, CODE OF CONDUCT AND OTHER REQUIREMENTS PERTAINING TO DOC FINANCIAL ASSISTANCE AWARDS, INCLUDING SUBAWARD AND PROCUREMENT ACTIONS	22
.01	Conflict of Interest and Code of Conduct	22
.02	Nonprocurement Debarment and Suspension.....	23
.03	Requirements for Subawards	23
.04	Requirements for Procurements.....	23
.05	Whistleblower Protections	24
.06	Small Businesses, Minority Business Enterprises and Women’s Business Enterprises	24
G.	NATIONAL POLICY REQUIREMENTS	25
.01	United States Laws and Regulations.....	25
.02	Non-Discrimination Requirements	25
a.	Statutory Provisions	25
b.	Other Provisions.....	26
c.	Title VII Exemption for Religious Organizations	27
.03	LOBBYING RESTRICTIONS.....	27
a.	Statutory Provisions	27
b.	Disclosure of Lobbying Activities	27
.04	Environmental Requirements.....	27
a.	The National Environmental Policy Act (42 U.S.C. §§ 4321 <i>et seq.</i>)	28
b.	The National Historic Preservation Act (16 U.S.C. §§ 470 <i>et seq.</i>)	28
c.	Executive Order 11988 (Floodplain Management) and Executive Order 11990 (Protection of Wetlands)	29
d.	Clean Air Act (42 U.S.C. §§ 7401 <i>et seq.</i>), Federal Water Pollution Control Act (33 U.S.C. §§ 1251 <i>et seq.</i>) (Clean Water Act), and Executive Order 11738 (“Providing for administration of the Clean Air Act and the Federal Water Pollution Control Act with respect to Federal contracts, grants or loans”)	29
e.	The Flood Disaster Protection Act (42 U.S.C. §§ 4002 <i>et seq.</i>)	29
f.	The Endangered Species Act (16 U.S.C. §§ 1531 <i>et seq.</i>).....	29
g.	The Coastal Zone Management Act (16 U.S.C. §§ 1451 <i>et seq.</i>).....	29
h.	The Coastal Barriers Resources Act (16 U.S.C. §§ 3501 <i>et seq.</i>).....	30
i.	The Wild and Scenic Rivers Act (16 U.S.C. §§ 1271 <i>et seq.</i>).....	30
j.	The Safe Drinking Water Act of 1974, as amended, (42 U.S.C. §§ 300f <i>et seq.</i>)	30
k.	The Resource Conservation and Recovery Act (42 U.S.C. §§ 6901 <i>et seq.</i>).....	30

l.	The Comprehensive Environmental Response, Compensation, and Liability Act (CERCLA, commonly known as Superfund) (42 U.S.C. §§ 9601 <i>et seq.</i>) and the Community Environmental Response Facilitation Act (42 U.S.C. § 9601 note <i>et seq.</i>)	30
m.	Executive Order 12898 (“Federal Actions to Address Environmental Justice in Minority Populations and Low Income Populations”)	30
n.	The Magnuson-Stevens Fishery Conservation and Management Act (16 U.S.C. § 1801 <i>et seq.</i>)	30
o.	Clean Water Act (CWA) Section 404 (33 U.S.C. § 1344)	31
p.	Rivers and Harbors Act (33 U.S.C. § 407)	31
q.	The Migratory Bird Treaty Act (16 U.S.C. §§ 703-712), Bald and Golden Eagle Protection Act (16 U.S.C. § 668 <i>et seq.</i>), and Executive Order 13186 (Responsibilities of Federal Agencies to Protect Migratory Birds, January 10, 2001)	31
r.	Executive Order 13112 (Invasive Species, February 3, 1999)	31
s.	Fish and Wildlife Coordination Act (16 U.S.C. § 661 <i>et seq.</i>)	31
.05	OTHER NATIONAL POLICY REQUIREMENTS	32
a.	Buy-American Preferences	32
b.	Criminal and Prohibited Activities	32
c.	Drug-Free Workplace	33
d.	Foreign Travel	33
e.	Increasing Seat Belt Use in the United States	34
f.	Federal Employee Expenses and Subawards or Contracts Issued to Federal Employees or Agencies	34
g.	Minority Serving Institutions Initiative	34
h.	Research Misconduct	35
i.	Research Involving Human Subjects	35
j.	Care and Use of Live Vertebrate Animals	36
k.	Management and Access to Data and Publications	37
l.	Homeland Security Presidential Directive	38
m.	Compliance with Department of Commerce Bureau of Industry and Security Export Administration Regulations	38
n.	The Trafficking Victims Protection Act of 2000 (22 U.S.C. § 7104(g)), as amended, and the implementing regulations at 2 C.F.R. Part 175	40
o.	The Federal Funding Accountability and Transparency Act (FFATA) (31 U.S.C. § 6101 note)	42
p.	Recipient Integrity and Performance Matters (Appendix XII to 2 C.F.R. Part 200)	47
q.	Never Contract with the Enemy (2 C.F.R Part 183; 2 C.F.R. § 200.215)	49

r. Prohibition on certain telecommunications and video surveillance services or equipment (Public Law 115-232, section 889; 2 C.F.R. § 200.216)	50
s. Federal Financial Assistance Planning During a Funding Hiatus or Government Shutdown	51

PREFACE

This document sets out the standard terms and conditions (ST&Cs) applicable to this U.S. Department of Commerce (DOC or Commerce) financial assistance award (hereinafter referred to as the DOC ST&Cs or Standard Terms). A non-Federal entity¹ receiving a DOC financial assistance award must, in addition to the assurances made as part of the application, comply and require each of its subrecipients, contractors, and subcontractors employed in the completion of the project to comply with all applicable statutes, regulations, executive orders (E.O.s), Office of Management and Budget (OMB) circulars, provisions of the OMB *Uniform Administrative Requirements, Cost Principles, and Audit Requirements for Federal Awards* (codified at 2 C.F.R. Part 200) (OMB Uniform Guidance), provisions of these Standard Terms, and any other terms and conditions incorporated into this DOC financial assistance award. In addition, unless otherwise provided by the terms and conditions of this DOC financial assistance award, Subparts A through E of 2 C.F.R. Part 200 and the Standard Terms are applicable to for-profit entities, foreign public entities and to foreign organizations that carry out a DOC financial assistance award.²

This award is subject to the laws and regulations of the United States. Any inconsistency or conflict in terms and conditions specified in the award will be resolved according to the following order of precedence: federal laws and regulations, applicable notices published in the *Federal Register*, E.O.s, OMB circulars, DOC ST&Cs, agency standard award conditions (if any), and specific award conditions. A specific award condition may amend or take precedence over a Standard Term on a case-by-case basis, when indicated by the specific award condition.

Some of the Standard Terms herein contain, by reference or substance, a summary of the pertinent statutes, regulations published in the *Federal Register* or Code of Federal Regulations (C.F.R.), E.O.s, OMB circulars, or the certifications and assurances provided by applicants through Standard Forms (*e.g.*, SF-424s) or through DOC forms (*e.g.* Form CD-511). To the extent that it is a summary, such Standard Term provision is not in derogation of, or an amendment to, any such statute, regulation, E.O., OMB circular, certification, or assurance.

¹ Note that the OMB Uniform Guidance uses the term “non-Federal entity” to generally refer to an entity that carries out a Federal award as a recipient or subrecipient. Because some of the provisions of these DOC ST&Cs apply to recipients rather than subrecipients, or vice versa, for clarity, these DOC ST&Cs use the terms “non-Federal entity,” “recipient,” and “subrecipient” consistent with their meanings in the OMB Uniform Guidance. In addition, the OMB Uniform Guidance uses the term “pass-through entity” to refer to a non-Federal entity that makes a subaward. As defined at 2 C.F.R. § 200.1:

“Non-Federal entity” is “a state, local government, Indian tribe, institution of higher education (IHE), or nonprofit organization that carries out a Federal award as a recipient or subrecipient.”

“Recipient” is “an entity, usually but not limited to non-Federal entities, that receives a Federal award directly from a Federal awarding agency. The term recipient does not include subrecipients or individuals that are beneficiaries of the award.”

“Subrecipient” is “an entity, usually but not limited to non-Federal entities, that receives a subaward from a pass-through entity to carry out part of a Federal award; but does not include an individual that is a beneficiary of such award. A subrecipient may also be a recipient of other Federal awards directly from a Federal awarding agency.”

“Pass-through entity” is “a non-Federal entity that provides a subaward to a subrecipient to carry out part of a Federal program.”

² See 2 C.F.R. § 200.1 for the definitions of “foreign public entity” and “foreign organization.”

DOC commenced implementation of the Research Terms and Conditions (RT&Cs) for Federal awards effective October 1, 2017; the RT&Cs address and implement the Uniform Guidance issued by OMB. For awards designated on the Form CD-450 (Financial Assistance Award) as Research, both the DOC ST&Cs and the RT&Cs as implemented by DOC apply to the award. The RT&Cs as well as the DOC implementation statement, agency specific requirements, prior approval matrix, subaward requirements, and national policy requirements are posted on the National Science Foundation's website – <https://www.nsf.gov/awards/managing/rtc.jsp>. The DOC ST&Cs and the RT&Cs are generally intended to harmonize with each other; however, where the DOC ST&Cs and the RT&Cs differ in a Research award, the RT&Cs prevail, unless otherwise indicated in a specific award condition.

A. PROGRAMMATIC REQUIREMENTS

.01 Reporting Requirements

a. Recipients must submit all reports as required by DOC, electronically or, if unable to submit electronically, in hard copy, as outlined below and as may be supplemented by the terms and conditions of a specific DOC award.

b. Performance (Technical) Reports. Recipients must submit performance (technical) reports to the Program Officer. Performance (technical) reports should be submitted in the same frequency as the Form SF-425 (Federal Financial Report), unless otherwise directed by the Grants Officer.

1. Performance (technical) reports must contain the information prescribed in 2 C.F.R. § 200.329 (Monitoring and reporting program performance), unless otherwise specified in the award conditions.

2. As appropriate and in accordance with the format provided by the Program Officer (or other OMB-approved information collections, including the Research Program Performance Report [RPPR] as adopted by DOC for use in research awards), recipients are required to relate financial data to the performance accomplishments of this Federal award. When applicable, recipients must also provide cost information to demonstrate cost effective practices (e.g., through unit cost data). The recipient's performance will be measured in a way that will help DOC to improve program outcomes, share lessons learned, and spread the adoption of best or promising practices. As described in 2 C.F.R. § 200.211 (Information contained in a Federal award), DOC will identify the timing and scope of expected performance by the recipient as related to the outcomes intended to be achieved by the Federal program.

3. Recipients (or pass-through entities as applicable) must submit a final performance report within 120 calendar days after the expiration of the period of performance. The subrecipient is required to submit its final performance report to the pass-through entity within 90 calendar days unless an extension has been granted.

c. Financial Reports. In accordance with 2 C.F.R. § 200.328 (Financial reporting), the recipient must submit a Form SF-425 (Federal Financial Report) or any successor form on a semi-annual basis for the periods ending March 31 and September 30, or any portion thereof, unless otherwise specified in a specific award condition. Reports must be submitted to DOC as directed by the Grants Officer, in accordance with the award conditions and are due no later than 30 calendar days following the end of each reporting period. Recipients (or pass-through entities as applicable) must submit a final Form SF-425 within 120 calendar days after the expiration of the period of performance. The subrecipient is required to submit its financial report to the pass-through entity within 90 calendar days unless an extension has been granted. A recipient may submit a final financial report in lieu of an interim financial report due at the end of the period of performance (e.g., in lieu of submitting a financial report for the last semi-annual or other reporting under an award, a recipient may submit a final (cumulative) financial report covering the entire award period).

d. Real Property, Tangible Personal Property and Intangible Property Reports and Requests for Dispositions. Unless otherwise required by the terms and conditions of a DOC financial assistance award, where real property, tangible personal property or intangible property is acquired or improved (in the case of real property or tangible personal property), or produced or acquired (in the case of intangible property), pursuant to a DOC award, non-Federal entities are required to submit the following real property, tangible personal property and intangible property reports (as appropriate):

1. Real Property Status Reports and Requests for Dispositions: Non-Federal entities must submit reports using Form SF-429 (Real Property Status Report) or any successor form, including appropriate attachments thereto, at least annually disclosing the status of real property that is Federally-owned property or real property in which the Federal Government retains a Federal Interest, unless the Federal Interest in the real property extends 15 years or longer. In cases where the Federal Interest attached is for a period of 15 years or more, the DOC or pass-through entity, at its option, may require the non-Federal entity to report at various multi-year frequencies (e.g., every two years or every three years, not to exceed a five-year reporting period; or, the DOC or pass-through entity may require annual reporting for the first three years of a Federal award and thereafter require reporting every five years). In addition, DOC or a pass-through entity may require a non-Federal entity to submit Form SF-429, with appropriate attachments, relating to a non-Federal entity's request to acquire, improve or contribute real property under a DOC financial assistance award. Non-Federal entities wishing to dispose of real property acquired or improved, in whole or in part, pursuant to a DOC award must request disposition instructions, including the submission of Form SF-429, with appropriate attachments, from the Grants Officer in accordance with the requirements set forth in 2 C.F.R. § 200.311(c). *See also* the real property standards set forth in Section C. of these Standard Terms (Property Standards).
2. Tangible Personal Property Status Reports and Requests for Dispositions: DOC or a pass-through entity may also require a non-Federal entity to submit periodic reports using Form SF-428 (Tangible Personal Property Report) or any successor form, including appropriate attachments thereto, concerning tangible personal property that is Federally-owned or tangible personal property in which the Federal Government retains an interest. In

addition, DOC or a pass-through entity may require a non-Federal entity to submit Form SF-428 in connection with a non-Federal entity's request to dispose of tangible personal property acquired under a DOC financial assistance award. Non-Federal entities wishing to dispose of tangible personal property acquired or improved, in whole or in part, pursuant to a DOC award must request disposition instructions, including the submission of Form SF-428, with appropriate attachments, from the Grants Officer in accordance with the requirements set forth in 2 C.F.R. § 200.313(e). *See also* the tangible property standards set forth in Section C. of these Standard Terms (Property Standards).

3. Intangible Property Status Reports and Requests for Dispositions: The specific requirements governing the development, reporting, and disposition of rights to intangible property, including inventions and patents resulting from DOC awards, are set forth in 37 C.F.R. Part 401, which is hereby incorporated by reference into this award. Non-Federal entities are required to submit their disclosures, elections, and requests for waiver from any requirement for substantial U.S. manufacture, electronically using the Interagency Edison extramural invention reporting system (iEdison) at www.iedison.gov. Non-Federal entities may obtain a waiver of this electronic submission requirement by providing to the Grants Officer compelling reasons for allowing the submission of paper reports. When no longer needed for the originally authorized purpose, disposition of the intangible property must occur in accordance with the provisions in 2 C.F.R. § 200.313(e). *See also* the intangible property standards set forth in Section C. of these Standard Terms (Property Standards).

e. Subawards and Executive Compensation Reports. For reporting requirements on subawards and Executive Compensation, see paragraph G.05.o of these Standard Terms (The Federal Funding Accountability and Transparency Act (FFATA) (31 U.S.C. § 6101 note)).

f. Recipient Integrity and Performance Matters. For reporting requirements pertaining to integrity and performance matters, see paragraph G.05.p of these Standard Terms (Recipient Integrity and Performance Matters (Appendix XII to 2 C.F.R. Part 200)).

g. Research Performance Progress Reports. All research awards shall submit the Research Performance Progress Report (RPPR) in accordance with instructions set forth in the following link: [RPPR Instructions](#).

.02 Revisions of Program Plans

In accordance with 2 C.F.R. § 200.308 (Revision of budget and program plans) and 2 C.F.R. § 200.407 (Prior written approval (prior approval)), the recipient must obtain prior written approval from the DOC Grants Officer for certain proposed programmatic change requests, unless otherwise provided by the terms and conditions of a DOC award. Requests for prior approval for changes to program plans must be submitted to the Federal Program Officer (or electronically for awards administered through Grants Online). Requests requiring prior DOC approval are not effective unless and until approved in writing by the DOC Grants Officer.

.03 Other Federal Awards with Similar Programmatic Activities

The recipient must immediately provide written notification to the DOC Program Officer and the DOC Grants Officer if, subsequent to receipt of the DOC award, other financial assistance is received to support or fund any portion of the scope of work incorporated into the DOC award. DOC will not pay for costs that are funded by other sources.

.04 Prohibition against Assignment by a Non-Federal Entity

A non-Federal entity must not transfer, pledge, mortgage, assign, encumber or hypothecate a DOC financial assistance award or subaward, or any rights to, interests therein or claims arising thereunder, to any party or parties, including but not limited to banks, trust companies, other financing or financial institutions, or any other public or private organizations or individuals without the express prior written approval of the DOC Grants Officer or the pass-through entity (which, in turn, may need to obtain prior approval from the DOC Grants Officer).

.05 Disclaimer Provisions

a. The United States expressly disclaims all responsibility or liability to the non-Federal entity or third persons (including but not limited to contractors) for the actions of the non-Federal entity or third persons resulting in death, bodily injury, property damages, or any other losses resulting in any way from the performance of this award or any subaward, contract, or subcontract under this award.

b. The acceptance of this award or any subaward by the non-Federal entity does not in any way constitute an agency relationship between the United States and the non-Federal entity or the non-Federal entity's contractors or subcontractors.

.06 Unsatisfactory Performance or Non-Compliance with Award Provisions

a. Failure to perform the work in accordance with the terms of the award and maintain satisfactory performance as determined by DOC may result in the imposition of additional award conditions pursuant to 2 C.F.R. § 200.208 (Specific conditions) or other appropriate enforcement action as specified in 2 C.F.R. § 200.339 (Remedies for noncompliance).

b. Failure to comply with the provisions of an award will be considered grounds for appropriate enforcement action pursuant to 2 C.F.R. § 200.339 (Remedies for noncompliance), including but not limited to: the imposition of additional award conditions in accordance with 2 C.F.R. § 200.208 (Specific conditions); temporarily withholding award payments pending the correction of the deficiency; changing the payment method to reimbursement only; the disallowance of award costs and the establishment of an accounts receivable; wholly or partially suspending or terminating an award; initiating suspension or debarment proceedings in accordance with 2 C.F.R. Parts 180 and 1326; and such other remedies as may be legally available.

c. 2 C.F.R. §§ 200.340 (Termination) through 200.343 (Effects of suspension and termination) apply to an award that is terminated prior to the end of the period of performance

due to the non-federal entity's material failure to comply with the award terms and conditions. In addition, the failure to comply with the provisions of a DOC award may adversely impact the availability of funding under other active DOC or Federal awards and may also have a negative impact on a non-Federal entity's eligibility for future DOC or Federal awards.

B. FINANCIAL REQUIREMENTS

.01 Financial Management

a. In accordance with 2 C.F.R. § 200.302(a) (Financial Management), each State must expend and account for the Federal award in accordance with State laws and procedures for expending and accounting for the State's own funds. In addition, the State's and any other non-Federal entity's financial management systems, including records documenting compliance with Federal statutes, regulations, and the terms and conditions of the Federal award, must be sufficient to permit the preparation of reports required by general and program-specific terms and conditions; and the tracing of funds to a level of expenditures adequate to establish that such funds have been used in accordance with Federal statutes, regulations, and the terms and conditions applicable to the Federal award. *See also* 2 C.F.R. § 200.450 (Lobbying) for additional management requirements to verify that Federal funds are not used for unallowable lobbying costs.

b. The financial management system of each non-Federal entity must provide all information required by 2 C.F.R. § 200.302(b). *See also* 2 C.F.R. §§ 200.334 (Retention requirements for records); 200.335 (Requests for transfer of records); 200.336 (Methods for collection, transmission and storage of information); 200.337 (Access to records); and 200.338 (Restrictions on public access to records).

.02 Award Payments

a. Consistent with 2 C.F.R. § 200.305(a) (Federal payment), for States, payments are governed by Treasury-State Cash Management Improvement Act (CMIA) agreements and default procedures codified at 31 C.F.R. Part 205 (Rules and Procedures for Efficient Federal-State Funds Transfers) and Treasury Financial Manual Volume I, 4A-2000 (Overall Disbursing Rules for All Federal Agencies).

b. Consistent with 2 C.F.R. § 200.305(b), for non-Federal entities other than States, payment methods must minimize the amount of time elapsing between the transfer of funds from the U.S. Treasury or the pass-through entity and the disbursement by the non-Federal entity.

1. The Grants Officer determines the appropriate method of payment and, unless otherwise stated in a specific award condition, the advance method of payment must be authorized. Advances must be limited to the minimum amounts needed and be timed to be in accordance with the actual, immediate cash requirements of the non-Federal entity in carrying out the purpose of the approved program or project. Unless otherwise provided by the terms and conditions of a DOC award, non-Federal entities must time advance payment requests so that Federal funds are on hand for a maximum of 30 calendar days before being disbursed by the

non-Federal entity for allowable award costs.

2. If a non-Federal entity demonstrates an unwillingness or inability to establish procedures that will minimize the time elapsing between the transfer of funds and disbursement by the non-Federal entity or if a non-Federal entity otherwise fails to continue to qualify for the advance method of payment, the Grants Officer or the pass-through entity may change the method of payment to reimbursement only.

c. Unless otherwise provided for in the award terms, payments from DOC to recipients under this award will be made using the Department of Treasury's Automated Standard Application for Payment (ASAP) system. Under the ASAP system, payments are made through preauthorized electronic funds transfers directly to the recipient's bank account, in accordance with the requirements of the Debt Collection Improvement Act of 1996. To receive payments under ASAP, recipients are required to enroll with the Department of Treasury, Financial Management Service, Regional Financial Centers, which allows them to use the on-line and Voice Response System (VRS) method of withdrawing funds from their ASAP established accounts. The following information will be required to make withdrawals under ASAP:

1. ASAP account number – the Federal award identification number found on the cover sheet of the award;
2. Agency Location Code (ALC); and
3. Region Code.

d. Recipients enrolled in the ASAP system do not need to submit a Form SF-270 (Request for Advance or Reimbursement) for payments relating to their award. Awards paid under the ASAP system will contain a specific award condition, clause, or provision describing enrollment requirements and any controls or withdrawal limits set in the ASAP system.

e. When the Form SF-270 or successor form is used to request payment, the recipient must submit the request no more than monthly, and advances must be approved for periods to cover only expenses reasonably anticipated over the next 30 calendar days. Prior to receiving payments via the Form SF-270, the recipient must complete and submit to the Grants Officer the Form SF-3881 (ACH Vendor Miscellaneous Payment Enrollment Form) or successor form along with the initial Form SF-270. Form SF-3881 enrollment must be completed before the first award payment can be made via a Form SF-270 request.

f. The Federal award identification number must be included on all payment-related correspondence, information, and forms.

g. Non-Federal entities receiving advance award payments must adhere to the depository requirements set forth in 2 C.F.R. §§ 200.305(b)(7) through (b)(11). Interest amounts up to \$500 per non-Federal entity's fiscal year may be retained by the non-Federal entity for administrative expenses.

.03 Federal and Non-Federal Sharing

a. Awards that include Federal and non-Federal sharing incorporate a budget consisting of shared allowable costs. If actual allowable costs are less than the total approved budget, the Federal and non-Federal cost shares must be calculated by applying the approved Federal and non-Federal cost share ratios to actual allowable costs. If actual allowable costs exceed the total approved budget, the Federal share must not exceed the total Federal dollar amount authorized by the award.

b. The non-Federal share, whether in cash or third-party in-kind contributions, is to be paid out at the same general rate as the Federal share. Exceptions to this requirement may be granted by the Grants Officer based on sufficient documentation demonstrating previously determined plans for, or later commitment of, cash or third-party in-kind contributions. In any case, the recipient must meet its cost share commitment as set forth in the terms and conditions of the award; failure to do so may result in the assignment of specific award conditions or other further action as specified in Standard Term A.06 (Unsatisfactory Performance or Non-Compliance with Award Provisions). The non-Federal entity must create and maintain sufficient records justifying all non-Federal sharing requirements to facilitate questions and audits; see Section D of these Standard Terms (Audits), for audit requirements. *See* 2 C.F.R. § 200.306 for additional requirements regarding cost sharing.

.04 Budget Changes and Transfer of Funds among Categories

a. Recipients are required to report deviations from the approved award budget and request prior written approval from DOC in accordance with 2 C.F.R. § 200.308 (Revision of budget and program plans) and 2 C.F.R. § 200.407 (Prior written approval (prior approval)). Requests for such budget changes must be submitted to the Grants Officer (or electronically for awards serviced through Grants Online) who will notify the recipient of the final determination in writing. Requests requiring prior DOC approval do not become effective unless and until approved in writing by the DOC Grants Officer.

b. In accordance with 2 C.F.R. § 200.308(f), transfers of funds by the recipient among direct cost categories are permitted for awards in which the Federal share of the project is equal to or less than the simplified acquisition threshold. For awards in which the Federal share of the project exceeds the simplified acquisition threshold, transfers of funds among direct cost categories must be approved in writing by the Grants Officer when the cumulative amount of such direct costs transfers exceeds 10 percent of the total budget as last approved by the Grants Officer. The 10 percent threshold applies to the total Federal and non-Federal funds authorized by the Grants Officer at the time of the transfer request. This is the accumulated amount of Federal funding obligated to date by the Grants Officer along with any non-Federal share. The same requirements apply to the cumulative amount of transfer of funds among programs, functions, and activities. This transfer authority does not authorize the recipient to create new budget categories within an approved budget without Grants Officer approval. Any transfer that causes any Federal appropriation, or part thereof, to be used for an unauthorized purpose is not and will not be permitted. In addition, this provision does not prohibit the recipient from requesting Grants Officer approval for revisions to the budget. *See* 2 C.F.R. § 200.308 (Revision

of budget and program plans) (as applicable) for specific requirements concerning budget revisions and transfer of funds between budget categories.

.05 Program Income

Unless otherwise indicated in the award terms, program income may be used for any required cost sharing or added to the project budget, consistent with 2 C.F.R. § 200.307 (Program income).

.06 Indirect or Facilities and Administrative Costs

a. Indirect costs (or facilities and administration costs (F&A)) for major institutions of higher education and major nonprofit organizations can generally be defined as costs incurred for a common or joint purpose benefitting more than one cost objective, and not readily assignable to the cost objectives specifically benefited, without effort disproportionate to the results achieved. Indirect costs will not be allowable charges against an award unless permitted under the award and specifically included as a line item in the award's approved budget.

b. Unrecovered indirect costs, including unrecovered indirect costs on cost sharing or matching, may be included as part of cost sharing or matching as allowed under 2 C.F.R. § 200.306(c) (Cost sharing or matching) or the terms and conditions of a DOC award.

c. Cognizant Agency for Indirect (F&A) Costs. OMB established the cognizant agency concept, under which a single agency represents all others in dealing with non-Federal entities in common areas. The cognizant agency for indirect costs reviews and approves non-Federal entities' indirect cost rates. In accordance with Appendices III – VII to 2 C.F.R. Part 200 the cognizant agency for indirect costs reviews and approves non-Federal entities' indirect cost rates. With respect to for-profit organizations, the term cognizant Federal agency generally is defined as the agency that provides the largest dollar amount of negotiated contracts, including options. *See* 48 C.F.R. § 42.003. If the only Federal funds received by a commercial organization are DOC award funds, then DOC becomes the cognizant Federal agency for indirect cost negotiations.

1. General Review Procedures Where DOC is the Cognizant Agency.

i. Within 90 calendar days of the award start date, the recipient must submit to the Grants Officer any documentation (indirect cost proposal, cost allocation plan, etc.) necessary to allow DOC to perform the indirect cost rate proposal review. Below are two sources available for guidance on how to put an indirect cost plan together:

- (A) Department of Labor: <https://www.dol.gov/oasam/boc/dcd/np-comm-guide.htm>
or
- (B) Department of the Interior: <https://www.doi.gov/ibc/services/finance/indirect-Cost-Services/>.

ii. The recipient may use the rate proposed in the indirect cost plan as a provisional rate until the DOC provides a response to the submitted plan.

iii. The recipient is required to annually submit indirect cost proposals no later than six months after the recipient's fiscal year end, except as otherwise provided by 2 C.F.R. § 200.414(g).

2. When DOC is not the oversight or cognizant Federal agency, the recipient must provide the Grants Officer with a copy of a negotiated rate agreement or a copy of the transmittal letter submitted to the cognizant or oversight Federal agency requesting a negotiated rate agreement within 30 calendar days of receipt of a negotiated rate agreement or submission of a negotiated rate proposal.

3. If the recipient is proposing indirect costs as part of a project budget, but is not required to have a negotiated rate agreement pursuant to 2 C.F.R. Part 200, Appendix VII, Paragraph D.1.b (*i.e.*, a governmental department or agency that receives \$35 million or less in direct Federal funding), the recipient may be required to provide the Grants Officer with a copy of its Certificate of Indirect Costs as referenced in 2 C.F.R. Part 200, Appendix VII, Paragraph D.3. or such other documentation, acceptable in form and substance to the Grants Officer, sufficient to confirm that proposed indirect costs are calculated and supported by documentation in accordance with 2 C.F.R. Part 200, Appendix VII. In cases where the DOC is the recipient's cognizant Federal agency, the DOC reserves the right, pursuant to 2 C.F.R. Part 200, Appendix VII, Paragraph D.1.b, to require the recipient to submit its indirect cost rate proposal for review by DOC.

d. If the recipient fails to submit required documentation to DOC within 90 calendar days of the award start date, the Grants Officer may amend the award to preclude the recovery of any indirect costs under the award. If the DOC, oversight, or cognizant Federal agency determines there is a finding of good and sufficient cause to excuse the recipient's delay in submitting the documentation, an extension of the 90-day due date may be approved by the Grants Officer.

e. The maximum dollar amount of allocable indirect costs for which DOC will reimburse the recipient is the lesser of:

1. The line item amount for the Federal share of indirect costs contained in the approved award budget, including all budget revisions approved in writing by the Grants Officer; or

2. The Federal share of the total indirect costs allocable to the award based on the indirect cost rate approved by the cognizant agency for indirect costs and applicable to the period in which the cost was incurred, in accordance with 2 C.F.R. 200 Appendix III, C.7, provided that the rate is approved on or before the award end date.

f. In accordance with 2 CFR § 200.414(c)(3), DOC set forth policies, procedures, and general decision-making criteria for deviations from negotiated indirect cost rates. These policies and procedures are applicable to all Federal financial assistance programs awarded and administered by DOC bureaus as Federal awarding agencies and may be found at http://www.osec.doc.gov/oam/grants_management/policy/documents/FAM%202015-02.pdf.

g. In accordance with 2 CFR § 200.414(g), any non-Federal entity that has a negotiated indirect cost rate may apply to the entity's cognizant agency for indirect costs for a one-time extension of a currently negotiated indirect cost rate for a period of up to four years, reducing the frequency of rate calculations and negotiations between an institution and its cognizant agency.

h. In accordance with 2 CFR § 200.414(f), any non-Federal entity that does not have a current negotiated (including provisional) rate, except for those non-Federal entities described in paragraph D.1.b of Appendix VII to 2 CFR Part 200, may elect to charge a de minimis rate of 10 percent of modified total direct costs. No documentation is required to justify the 10 percent de minimis indirect cost rate.

.07 Incurring Costs or Obligating Federal Funds Before and After the Period of Performance

a. In accordance with 2 C.F.R. § 200.309 (Modifications to Period of Performance) and the terms and conditions of a DOC award, a non-Federal entity may charge to the Federal award only allowable costs incurred during the period of performance, which is established in the award document. As defined at 2 C.F.R. § 200.1, the "period of performance" means the total estimated time interval between the start of an initial Federal award and the planned end date, which may include one or more funded portions, or budget periods. Identification of the Period of Performance in the Federal award per § 200.211(b)(5) does not commit the awarding agency to fund the award beyond the currently approved budget period." The period of performance may sometimes be referred to as the project period or award period. This Standard Term is subject to exceptions for allowable costs pertaining to: (i) pre-award costs (*see* 2 C.F.R. § 200.458); (ii) publication and printing costs (*see* 2 C.F.R. § 200.461); and administrative costs incurred relating to the close-out of an award (*see* 2 C.F.R. § 200.344).

b. Reasonable, necessary, allowable and allocable administrative award closeout costs are authorized for a period of up to 120 calendar days following the end of the period of performance. For this purpose, award closeout costs are those strictly associated with close-out activities and are typically limited to the preparation of final progress, financial, and required project audit reports, unless otherwise approved in writing by the Grants Officer. A non-Federal entity may request an extension of the 120-day closeout period, as provided in 2 C.F.R. § 200.344 (Closeout).

c. Unless authorized by a specific award condition, any extension of the period of performance may only be authorized by the Grants Officer in writing. This is not a delegable authority. Verbal or written assurances of funding from anyone other than the Grants Officer does not constitute authority to obligate funds for programmatic activities beyond the end of the period of performance.

d. The DOC has no obligation to provide any additional prospective funding. Any amendment of the award to increase funding and to extend the period of performance is at the sole discretion of DOC.

.08 Tax Refunds

The non-Federal entity shall contact the Grants Officer immediately upon receipt of the refund of any taxes, including but not limited to Federal Insurance Contributions Act (FICA) taxes, Federal Unemployment Tax Act (FUTA) taxes, or Value Added Taxes (VAT) that were allowed as charges to a DOC award, regardless of whether such refunds are received by the non-Federal entity during or after the period of performance. The Grants Officer will provide written disposition instructions to the non-Federal entity, which may include the refunded taxes being credited to the award as either a cost reduction or a cash refund, or may allow the non-Federal entity to use such refunds for approved activities and costs under a DOC award. *See* 2 C.F.R. § 200.470 (Taxes (including Value Added Tax)).

.09 Internal Controls

Each recipient must comply with standards for internal controls described at 2 C.F.R. § 200.303 (Internal controls). The “Standards for Internal Control in the Federal Government” issued by the Comptroller General of the United States referenced in § 200.303 are available online at <http://www.gao.gov/assets/80/76455.pdf> and the “Internal Control Integrated Framework” issued by the Committee of Sponsoring Organizations of the Treadway Commission (COSO) is available online at [Internal Control Guidance](#).

C. PROPERTY STANDARDS

.01 Standards

Each non-Federal entity must comply with the Property Standards set forth in 2 C.F.R. §§ 200.310 (Insurance coverage) through 200.316 (Property trust relationship).

.02 Real and Personal Property

a. In accordance with 2 C.F.R. § 200.316 (Property trust relationship), real property, equipment, and other personal property acquired or improved with a Federal award must be held in trust by the non-Federal entity as trustee for the beneficiaries of the project or program under which the property was acquired or improved. This trust relationship exists throughout the duration of the property’s estimated useful life, as determined by the Grants Officer in consultation with the Program Office, during which time the Federal Government retains an undivided, equitable reversionary interest in the property (Federal Interest). During the duration of the Federal Interest, the non-Federal entity must comply with all use and disposition requirements and restrictions as set forth in 2 C.F.R. §§ 200.310 (Insurance coverage) through 200.316 (Property trust relationship), as applicable, and in the terms and conditions of the Federal award.

b. The Grants Officer may require a non-Federal entity to execute and to record (as applicable) a statement of interest, financing statement (form UCC-1), lien, mortgage or other public notice of record to indicate that real or personal property acquired or improved in whole or in part with Federal funds is subject to the Federal Interest, and that certain use and disposition

requirements apply to the property. The statement of interest, financing statement (Form UCC 1), lien, mortgage or other public notice must be acceptable in form and substance to the DOC and must be placed on record in accordance with applicable State and local law, with continuances re-filed as appropriate. In such cases, the Grants Officer may further require the non-Federal entity to provide the DOC with a written statement from a licensed attorney in the jurisdiction where the property is located, certifying that the Federal Interest has been protected, as required under the award and in accordance with applicable State and local law. The attorney's statement, along with a copy of the instrument reflecting the recordation of the Federal Interest, must be returned to the Grants Officer. Without releasing or excusing the non-Federal entity from these obligations, the non-Federal entity, by execution of the financial assistance award or by expending Federal financial assistance funds (in the case of a subrecipient), authorizes the Grants Officer and/or program office to file such notices and continuations as it determines to be necessary or convenient to disclose and protect the Federal Interest in the property. The Grants Officer may elect not to release any or a portion of the Federal award funds until the non-Federal entity has complied with this provision and any other applicable award terms or conditions, unless other arrangements satisfactory to the Grants Officer are made.

.03 Intellectual Property Rights

a. General. The rights to any work or other intangible property produced or acquired under a Federal award are determined by 2 C.F.R. § 200.315 (Intangible property). The non-Federal entity owns any work produced or purchased under a Federal award subject to the DOC's royalty-free, nonexclusive, and irrevocable right to obtain, reproduce, publish, or otherwise use the work or authorize others to receive, reproduce, publish, or otherwise use the work for Government purposes.

b. Inventions. Unless otherwise provided by law, the rights to any invention made by a non-Federal entity under a DOC financial assistance award are determined by the Bayh-Dole Act, Pub. L. No. 96-517, as amended, and as codified in 35 U.S.C. § 200 *et seq.*, and modified by E.O. 12591 (52 FR 13414), as amended by E.O. 12618 (52 FR 48661). 35 U.S.C. § 201(h) defines "small business firm" as "a small business concern as defined at section 2 of Public Law 85-536 (15 U.S.C. 632) and implementing regulations of the Administrator of the Small Business Administration." Section 1(b)(4) of E.O. 12591 extended the Bayh-Dole Act to non-Federal entities "regardless of size" to the extent permitted by law. The specific requirements governing the development, reporting, and disposition of rights to inventions and patents resulting from Federal awards are described in more detail in 37 C.F.R. Part 401, which implements 35 U.S.C. 202 through 204 and includes standard patent rights clauses in 37 C.F.R. § 401.14, which is hereby incorporated by reference into this award.

The Bayh-Dole regulations set forth in 37 C.F.R. parts 401 and 404 were amended by 83 FR 15954, with an effective date of May 14, 2018 (Amended Bayh-Dole Regulations). The Amended Bayh-Dole Regulations apply to all new financial assistance awards issued on or after May 14, 2018. The Amended Bayh-Dole Regulations do not apply to financial assistance awards issued prior to May 14, 2018, including amendments made to such awards, unless an award amendment includes a specific condition incorporating the Amended Bayh-Dole Regulations into the terms and conditions of the subject award.

1. Ownership. A non-Federal entity may have rights to inventions in accordance with 37 C.F.R. Part 401. These requirements are technical in nature and non-Federal entities are encouraged to consult with their Intellectual Property counsel to ensure the proper interpretation of and adherence to the ownership rules. Unresolved questions pertaining to a non-Federal entities' ownership rights may further be addressed to the Grants Officer.

2. Responsibilities - iEdison. The non-Federal entity must comply with all the requirements of the standard patent rights clause and 37 C.F.R. Part 401, including the standard patent rights clause in 37 C.F.R. § 401.14. Non-Federal entities are required to submit their disclosures, elections, and requests for waiver from any requirement for substantial U.S. manufacture, electronically using the Interagency Edison extramural invention reporting system (iEdison) at www.iedison.gov. Non-Federal entities may obtain a waiver of this electronic submission requirement by providing the Grants Officer with compelling reasons for allowing the submission of paper reports.

c. Patent Notification Procedures. Pursuant to E.O. 12889 (58 FR 69681), the DOC is required to notify the owner of any valid patent covering technology whenever the DOC or a non-Federal entity, without making a patent search, knows (or has demonstrable reasonable grounds to know) that technology covered by a valid United States patent has been or will be used without a license from the owner. To ensure proper notification, if the non-Federal entity uses or has used patented technology under this award without a license or permission from the owner, the non-Federal entity must notify the Grants Officer.

This notice does not constitute authorization or consent by the Government to any copyright or patent infringement occurring under the award.

d. A non-Federal entity may copyright any work produced under a Federal award, subject to the DOC's royalty-free, nonexclusive, and irrevocable right to obtain, reproduce, publish, or otherwise use the work, or authorize others to do so for Government purposes. Works jointly authored by DOC and non-Federal entity employees may be copyrighted, but only the part of such works authored by the non-Federal entity is protectable in the United States because, under 17 U.S.C. § 105, copyright protection is not available within the United States for any work of the United States Government. On occasion and as permitted under 17 U.S.C. § 105, DOC may require the non-Federal entity to transfer to DOC a copyright in a particular work for Government purposes or when DOC is undertaking primary dissemination of the work.

e. Freedom of Information Act (FOIA). In response to a FOIA request for research data relating to published research findings (as defined by 2 C.F.R. § 200.315(e)(2)) produced under a Federal award that were used by the Federal government in developing an agency action that has the force and effect of law, the DOC will request, and the non-Federal entity must provide, within a reasonable time, the research data so that they can be made available to the public through the procedures established under the FOIA.

D. AUDITS

Under the Inspector General Act of 1978, as amended, 5 U.S.C. App. 3, §§ 1 *et seq.*, an audit of the award may be conducted at any time. The Inspector General of the DOC, or any of his or her duly authorized representatives, must have the right to access any pertinent books, documents, papers, and records of the non-Federal entity, whether written, printed, recorded, produced, or reproduced by any electronic, mechanical, magnetic, or other process or medium, to make audits, inspections, excerpts, transcripts, or other examinations as authorized by law. This right also includes timely and reasonable access to the non-Federal entity's personnel for interview and discussion related to such documents. *See* 2 C.F.R. § 200.337 (Access to records). When the DOC Office of Inspector General (OIG) requires a program audit on a DOC award, the OIG will usually make the arrangements to audit the award, whether the audit is performed by OIG personnel, an independent accountant under contract with DOC, or any other Federal, State, or local audit entity.

.01 Organization-Wide, Program-Specific, and Project Audits

a. A recipient must, within 90 days of the end of its fiscal year, notify the Grants Officer of the amount of Federal awards, including all DOC and non-DOC awards, that the recipient expended during its fiscal year.

b. Recipients that are subject to the provisions of Subpart F of 2 C.F.R. Part 200 and that expend \$750,000 or more in a year in Federal awards during their fiscal year must have an audit conducted for that year in accordance with the requirements contained in Subpart F of 2 C.F.R. Part 200. Within the earlier of 30 calendar days after receipt of the auditor's report(s), or nine months after the end of the audit period, unless a different period is specified in a program-specific audit guide, a copy of the audit must be submitted electronically to the Federal Audit Clearinghouse (FAC) through the FAC's Internet Data Entry System (IDES) (<https://harvester.census.gov/facides/>). In accordance with 2 C.F.R. § 200.425 (Audit services), the recipient may include a line item in the budget for the allowable costs associated with the audit, which is subject to the approval of the Grants Officer.

c. Unless otherwise specified in the terms and conditions of the award, entities that are not subject to Subpart F of 2 C.F.R. Part 200 (e.g., for-profit entities, foreign public entities and foreign organizations) and that expend \$750,000 or more in DOC funds during their fiscal year (including both as a recipient and a subrecipient) must submit to the Grants Officer either: (i) a financial related audit of each DOC award or subaward in accordance with Generally Accepted Government Auditing Standards (GAGAS); or (ii) a project specific audit for each award or subaward in accordance with the requirements contained in 2 C.F.R. § 200.507. Within the earlier of 30 calendar days after receipt of the auditor's report(s), or nine months after the end of the audit period, unless a different period is specified in a program-specific audit guide, a copy of the audit must be submitted to the Grants Officer. In accordance with 2 C.F.R. § 200.425, the recipient may include a line item in the budget for the allowable costs associated with the audit, which is subject to the approval of the Grants Officer. Entities that are not subject to Subpart F of 2 C.F.R. Part 200 and that expend less than \$750,000 in DOC funds in a given fiscal year are

not required to submit an audit(s) for that year, but must make their award-related records available to DOC or other designated officials for review and audit.

d. Recipients are responsible for compliance with the above audit requirements and for informing the Grants Officer of the status of their audit, including when the relevant audit has been completed and submitted in accordance with the requirements of this section. Failure to provide audit reports within the timeframes specified above may result in appropriate enforcement action, up to and including termination of the award, and may jeopardize eligibility for receiving future DOC awards.

e. In accordance with 2 C.F.R. § 200.332(d)(3), pass-through entities are responsible for issuing a management decision for applicable audit findings pertaining only to the Federal award provided by the pass-through entity to a subrecipient.

.02 Audit Resolution Process

a. An audit of the award may result in the disallowance of costs incurred by the recipient and the establishment of a debt (account receivable) due to DOC. For this reason, the recipient should take seriously its responsibility to respond to all audit findings and recommendations with adequate explanations and supporting evidence whenever audit results are disputed.

b. A recipient whose award is audited has the following opportunities to dispute the proposed disallowance of costs and the establishment of a debt:

1. The recipient has 30 calendar days from the date of the transmittal of the draft audit report to submit written comments and documentary evidence.
2. The recipient has 30 calendar days from the date of the transmittal of the final audit report to submit written comments and documentary evidence.
3. The DOC will review the documentary evidence submitted by the recipient and will notify the recipient of the results in an *Audit Resolution Determination Letter*. The recipient has 30 calendar days from the date of receipt of the *Audit Resolution Determination Letter* to submit a written appeal, unless this deadline is extended in writing by the DOC. The appeal is the last opportunity for the recipient to submit written comments and documentary evidence to the DOC to dispute the validity of the audit resolution determination.
4. An appeal of the Audit Resolution Determination does not prevent the establishment of the audit-related debt nor does it prevent the accrual of applicable interest, penalties and administrative fees on the debt in accordance with 15 C.F.R. Part 19. If the Audit Resolution Determination is overruled or modified on appeal, appropriate corrective action will be taken retroactively.
5. The DOC will review the recipient's appeal and notify the recipient of the results in an *Appeal Determination Letter*. After the opportunity to appeal has expired or after the appeal determination has been rendered, DOC will not accept any further documentary evidence from the recipient. No other administrative appeals are available in DOC.

E. DEBTS

.01 Payment of Debts Owed to the Federal Government

a. The non-Federal entity must promptly pay any debts determined to be owed to the Federal Government. Any funds paid to a non-Federal entity in excess of the amount to which the non-Federal entity is finally determined to be entitled under the terms of the Federal award constitute a debt to the Federal government. In accordance with 2 C.F.R. § 200.346 (Collection of amounts due), if not paid within 90 calendar days after demand, DOC may reduce a debt owed to the Federal Government by:

1. Making an administrative offset against other requests for reimbursement;
2. Withholding advance payments otherwise due to the non-Federal entity; or
3. Taking any other action permitted by Federal statute.

The foregoing does not waive any claim on a debt that DOC may have against another entity, and all rights and remedies to pursue other parties are preserved.

b. DOC debt collection procedures are set out in 15 C.F.R. Part 19. In accordance with 2 C.F.R. § 200.346 (Collection of amounts due) and 31 U.S.C. § 3717, failure to pay a debt owed to the Federal Government must result in the assessment of interest, penalties and administrative costs in accordance with the provisions of 31 U.S.C. § 3717 and 31 C.F.R. § 901.9. Commerce entities will transfer any Commerce debt that is delinquent for more than 120 calendar days to the U.S. Department of the Treasury's Financial Management Service for debt collection services, a process known as cross-servicing, pursuant to 31 U.S.C. § 3711(g), 31 C.F.R. § 285.12, and 15 C.F.R. § 19.9. DOC may also take further action as specified in DOC ST&C A.06 (Unsatisfactory Performance or Non-Compliance with Award Provisions). Funds for payment of a debt must not come from other Federally-sponsored programs, and the DOC may conduct on-site visits, audits, and other reviews to verify that other Federal funds have not been used to pay a debt.

.02 Late Payment Charges

a. Interest will be assessed on the delinquent debt in accordance with section 11 of the Debt Collection Act of 1982, as amended (31 U.S.C. § 3717(a)). The minimum annual interest rate to be assessed is the U.S. Department of the Treasury's Current Value of Funds Rate (CVFR). The CVFR is available online at https://www.fiscal.treasury.gov/fsreports/rpt/cvfr/cvfr_home.htm and also published by the Department of the Treasury in the *Federal Register* (<http://www.gpo.gov/fdsys/browse/collection.action?collectionCode=FR>) and in the *Treasury Financial Manual Bulletin*. The assessed rate must remain fixed for the duration of the indebtedness.

b. Penalties will accrue at a rate of not more than six percent per year or such other higher rate as authorized by law.

c. Administrative charges, i.e., the costs of processing and handling a delinquent debt, will be determined by the Commerce entity collecting the debt, as directed by the Office of the Chief Financial Officer and Assistant Secretary for Administration.

.03 Barring Delinquent Federal Debtors from Obtaining Federal Loans or Loan Insurance Guarantees

Pursuant to 31 U.S.C. § 3720B and 31 C.F.R. § 901.6, unless waived by DOC, the DOC is not permitted to extend financial assistance in the form of a loan, loan guarantee, or loan insurance to any person delinquent on a nontax debt owed to a Federal agency. This prohibition does not apply to disaster loans.

.04 Effect of Judgment Lien on Eligibility for Federal Grants, Loans, or Programs

Pursuant to 28 U.S.C. § 3201(e), unless waived by the DOC, a debtor who has a judgment lien against the debtor's property for a debt to the United States is not eligible to receive any grant or loan that is made, insured, guaranteed, or financed directly or indirectly by the United States or to receive funds directly from the Federal Government in any program, except funds to which the debtor is entitled as beneficiary, until the judgment is paid in full or otherwise satisfied.

F. CONFLICT OF INTEREST, CODE OF CONDUCT AND OTHER REQUIREMENTS PERTAINING TO DOC FINANCIAL ASSISTANCE AWARDS, INCLUDING SUBAWARD AND PROCUREMENT ACTIONS

.01 Conflict of Interest and Code of Conduct

a. DOC Conflict of Interest Policy. In accordance with 2 C.F.R. § 200.112 (Conflict of interest), the non-Federal entity must disclose in writing any potential conflict of interest to the DOC or pass-through entity. In addition, a non-Federal entity will establish and maintain written standards of conduct that include safeguards to prohibit employees from using their positions for a purpose that constitutes or presents the appearance of personal or organizational conflict of interest, or personal gain in the administration of an award. It is the DOC's policy to maintain the highest standards of conduct and to prevent real or apparent conflicts of interest in connection with DOC financial assistance awards.

b. A conflict of interest generally exists when an interested party participates in a matter that has a direct and predictable effect on the interested party's personal or financial interests. A financial interest may include employment, stock ownership, a creditor or debtor relationship, or prospective employment with the organization selected or to be selected for a subaward. A conflict also may exist where there is an appearance that an interested party's objectivity in performing his or her responsibilities under the project is impaired. For example, an appearance of impairment of objectivity may result from an organizational conflict where, because of other activities or relationships with other persons or entities, an interested party is unable to render

impartial assistance, services or advice to the recipient, a participant in the project or to the Federal Government. Additionally, a conflict of interest may result from non-financial gain to an interested party, such as benefit to reputation or prestige in a professional field. For purposes of the DOC Conflict of Interest Policy, an interested party includes, but is not necessarily limited to, any officer, employee or member of the board of directors or other governing board of a non-Federal entity, including any other parties that advise, approve, recommend, or otherwise participate in the business decisions of the recipient, such as agents, advisors, consultants, attorneys, accountants or shareholders. This also includes immediate family and other persons directly connected to the interested party by law or through a business arrangement.

c. Procurement-related conflict of interest. In accordance with 2 C.F.R. § 200.318 (General procurement standards), non-Federal entities must maintain written standards of conduct covering conflicts of interest and governing the performance of their employees engaged in the selection, award and administration of contracts. *See* paragraph F.04 of these Standard Terms (Requirements for Procurements).

.02 Nonprocurement Debarment and Suspension

Non-Federal entities must comply with the provisions of 2 C.F.R. Part 1326 (Nonprocurement Debarment and Suspension), which generally prohibit entities that have been debarred, suspended, or voluntarily excluded from participating in Federal nonprocurement transactions either through primary or lower tier covered transactions, and which set forth the responsibilities of recipients of Federal financial assistance regarding transactions with other persons, including subrecipients and contractors.

.03 Requirements for Subawards

a. The recipient or pass-through entity must require all subrecipients, including lower tier subrecipients, to comply with the terms and conditions of a DOC financial assistance award, including applicable provisions of the OMB Uniform Guidance (2 C.F.R. Part 200), and all associated Terms and Conditions set forth herein. *See* 2 C.F.R. § 200.101(b)(2) (Applicability to different types of Federal awards), which describes the applicability of 2 C.F.R. Part 200 to various types of Federal awards and §§ 200.331-333 (Subrecipient monitoring and management).

b. The recipient or pass through entity may have more restrictive policies for the RTC *waived* prior approvals (no-cost extensions, re-budgeting, etc.) for their subaward recipients. Such restrictive policies must be addressed in their subaward agreements and in accordance with §200.331.

.04 Requirements for Procurements

a. States. Pursuant to 2 C.F.R. § 200.317 (Procurements by states), when procuring property and services under this Federal award, a State must follow the same policies and procedures it uses for procurements from its non-Federal funds. The State must comply with 2 C.F.R. §§ 200.321 (Contracting with small and minority businesses, women's business enterprises, and labor surplus area firms), 200.322 (Domestic preferences for procurements), and

200.323 (Procurement of recovered materials), and ensure that every purchase order or other contract includes any clauses required by 2 C.F.R. § 200.327 (Contract provisions).

b. Other Non-Federal Entities. All other non-Federal entities, including subrecipients of a State, must follow the procurement standards in 2 C.F.R. §§ 200.318 (General procurement standards) through 200.327 (Contract provisions) which include the requirement that non-Federal entities maintain written standards of conduct covering conflicts of interest and governing the performance of their employees engaged in the selection, award, and administration of contracts. No employee, officer, or agent may participate in the selection, award, or administration of a contract supported by a Federal award if he or she has a real or apparent conflict of interest.

.05 Whistleblower Protections

This award is subject to the whistleblower protections afforded by 41 U.S.C. § 4712 (Enhancement of contractor protection from reprisal for disclosure of certain information), which generally provide that an employee or contractor (including subcontractors and personal services contractors) of a non-Federal entity may not be discharged, demoted, or otherwise discriminated against as a reprisal for disclosing to a person or body information that the employee reasonably believes is evidence of gross mismanagement of a Federal award, subaward, or a contract under a Federal award or subaward, a gross waste of Federal funds, an abuse of authority relating to a Federal award or subaward or contract under a Federal award or subaward, a substantial and specific danger to public health or safety, or a violation of law, rule, or regulation related to a Federal award, subaward, or contract under a Federal award or subaward. These persons or bodies include:

- a. A Member of Congress or a representative of a committee of Congress.
- b. An Inspector General.
- c. The Government Accountability Office.
- d. A Federal employee responsible for contract or grant oversight or management at the relevant agency.
- e. An authorized official of the Department of Justice or other law enforcement agency.
- f. A court or grand jury.
- g. A management official or other employee of the contractor, subcontractor, or grantee who has the responsibility to investigate, discover, or address misconduct.

Non-Federal entities and contractors under Federal awards and subawards must inform their employees in writing of the rights and remedies provided under 41 U.S.C. § 4712, in the predominant native language of the workforce.

.06 Small Businesses, Minority Business Enterprises and Women's Business Enterprises

In accordance with 2 C.F.R. § 200.321 (Contracting with small and minority businesses, women's business enterprises, and labor surplus area firms), the recipient must take all necessary affirmative steps to assure that minority businesses, women's business enterprises, and labor surplus area firms are used when possible. DOC encourages non-Federal entities to use small

businesses, minority business enterprises and women's business enterprises in contracts under financial assistance awards. The Minority Business Development Agency within the DOC will assist non-Federal entities in matching qualified minority business enterprises with contract opportunities. For further information visit MBDA's website at <http://www.mbda.gov>. If you do not have access to the Internet, you may contact MBDA via telephone or mail:

U.S. Department of Commerce
Minority Business Development Agency
Herbert C. Hoover Building
14th Street and Constitution Avenue, N.W.
Washington, D.C. 20230
(202) 482-0101

G. NATIONAL POLICY REQUIREMENTS

.01 United States Laws and Regulations

This award is subject to the laws and regulations of the United States. The recipient must comply with all applicable requirements of all other Federal laws, executive orders, regulations and policies governing this program.

.02 Non-Discrimination Requirements

No person in the United States may, on the ground of race, color, national origin, handicap, age, religion, or sex, be excluded from participation in, be denied the benefits of, or be subject to discrimination under, any program or activity receiving Federal financial assistance. The recipient agrees to comply with the non-discrimination requirements below:

a. Statutory Provisions

1. Title VI of the Civil Rights Act of 1964 (42 U.S.C. §§ 2000d *et seq.*) and DOC implementing regulations published at 15 C.F.R. Part 8 prohibiting discrimination on the grounds of race, color, or national origin under programs or activities receiving Federal financial assistance;
2. Title IX of the Education Amendments of 1972 (20 U.S.C. §§ 1681 *et seq.*) prohibiting discrimination on the basis of sex under Federally assisted education programs or activities;
3. The Americans with Disabilities Act of 1990 (42 U.S.C. §§ 12101 *et seq.*) prohibiting discrimination on the basis of disability under programs, activities, and services provided or made available by State and local governments or instrumentalities or agencies thereto, as well as public or private entities that provide public transportation;
4. Section 504 of the Rehabilitation Act of 1973, as amended (29 U.S.C. § 794), and DOC implementing regulations published at 15 C.F.R. Part 8b prohibiting discrimination on the

basis of handicap under any program or activity receiving or benefiting from Federal assistance.

For purposes of complying with the accessibility standards set forth in 15 C.F.R. § 8b.18(c), non-federal entities must adhere to the regulations, published by the U.S. Department of Justice, implementing Title II of the Americans with Disabilities Act (ADA) (28 C.F.R. part 35; 75 FR 56164, as amended by 76 FR 13285) and Title III of the ADA (28 C.F.R. part 36; 75 FR 56164, as amended by 76 FR 13286). The revised regulations adopted new enforceable accessibility standards called the “2010 ADA Standards for Accessible Design” (2010 Standards), which replace and supersede the former Uniform Federal Accessibility Standards for new construction and alteration projects;

5. The Age Discrimination Act of 1975, as amended (42 U.S.C. §§ 6101 *et seq.*), and DOC implementing regulations published at 15 C.F.R. Part 20 prohibiting discrimination on the basis of age in programs or activities receiving Federal financial assistance; and
6. Any other applicable non-discrimination law(s).

b. Other Provisions

1. Parts II and III of E.O. 11246 (Equal Employment Opportunity, 30 FR 12319),³ which requires Federally assisted construction contracts to include the nondiscrimination provisions of §§ 202 and 203 of E.O. 11246 and Department of Labor regulations implementing E.O. 11246 (41 C.F.R. § 60-1.4(b)).
2. E.O. 13166 (65 FR 50121, Improving Access to Services for Persons with Limited English Proficiency), requiring Federal agencies to examine the services provided, identify any need for services to those with limited English proficiency (LEP), and develop and implement a system to provide those services so LEP persons can have meaningful access to them. The DOC issued policy guidance on March 24, 2003 (68 FR 14180) to articulate the Title VI prohibition against national origin discrimination affecting LEP persons and to help ensure that non-Federal entities provide meaningful access to their LEP applicants and beneficiaries.
3. In accordance with E.O. 13798 and Office of Management and Budget, M-20-09 – Guidance Regarding Federal Grants, states or other public grantees may not condition sub-awards of Federal grant money in a manner that would disadvantage grant applicants based on their religious character.

³ As amended by E.O. 11375(32 FR 14303), E.O. 11478 (34 FR 12985), E.O. 12086 (43 FR 46501), E.O. 12107 (44 FR 1055), E.O. 13279 (F67 FR 77141), E.O. 13665 (79 FR 20749), and E.O. 13672 (79 FR 42971).

c. Title VII Exemption for Religious Organizations

Generally, Title VII of the Civil Rights Act of 1964, 42 U.S.C. §§ 2000e *et seq.*, provides that it is an unlawful employment practice for an employer to discharge any individual or otherwise to discriminate against an individual with respect to compensation, terms, conditions, or privileges of employment because of such individual's race, color, religion, sex, or national origin. However, Title VII, 42 U.S.C. § 2000e-1(a), expressly exempts from the prohibition against discrimination based on religion, "a religious corporation, association, educational institution, or society with respect to the employment of individuals of a particular religion to perform work connected with the carrying on by such corporation, association, educational institution, or society of its activities."

.03 LOBBYING RESTRICTIONS

a. Statutory Provisions

Non-Federal entities must comply with 2 C.F.R. § 200.450 (Lobbying), which incorporates the provisions of 31 U.S.C. § 1352; and OMB guidance and notices on lobbying restrictions. In addition, non-Federal entities must comply with the DOC regulations published at 15 C.F.R. Part 28, which implement the New Restrictions on Lobbying. These provisions prohibit the use of Federal funds for lobbying the executive or legislative branches of the Federal Government in connection with the award and require the disclosure of the use of non-Federal funds for lobbying. Lobbying includes attempting to improperly influence, meaning any influence that induces or tends to induce a Federal employee or officer to give consideration or to act regarding a Federal award or regulatory matter on any basis other than the merits of the matter, either directly or indirectly. Costs incurred to improperly influence are unallowable. *See* 2 C.F.R. § 200.450(b) and (c).

b. Disclosure of Lobbying Activities

Any recipient that receives more than \$100,000 in Federal funding and conducts lobbying with non-federal funds relating to a covered Federal action must submit a completed Form SF-LLL (Disclosure of Lobbying Activities). The Form SF-LLL must be submitted within 30 calendar days following the end of the calendar quarter in which there occurs any event that requires disclosure or that materially affects the accuracy of the information contained in any disclosure form previously filed. The recipient must submit any required SF-LLL forms, including those received from subrecipients, contractors, and subcontractors, to the Grants Officer.

.04 Environmental Requirements

Environmental impacts must be considered by Federal decision makers in their decisions whether or not to approve: (1) a proposal for Federal assistance; (2) the proposal with mitigation; or (3) a different proposal having less adverse environmental impacts. Federal environmental laws require that the funding agency initiate an early planning process that considers potential impacts that projects funded with Federal assistance may have on the environment. Each non-Federal entity must comply with all environmental standards, to include those prescribed under

the following statutes and E.O.s and must identify to the awarding agency any impact the award may have on the environment. In some cases, award funds can be withheld by the Grants Officer under a specific award condition requiring the non-Federal entity to submit additional environmental compliance information sufficient to enable the DOC to make an assessment on any impacts that a project may have on the environment.

a. The National Environmental Policy Act (42 U.S.C. §§ 4321 *et seq.*)

The National Environmental Policy Act (NEPA) and the Council on Environmental Quality (CEQ) implementing regulations (40 C.F.R. Parts 1500 through 1508) require that an environmental analysis be completed for all major Federal actions to determine whether they have significant impacts on the environment. NEPA applies to the actions of Federal agencies and may include a Federal agency's decision to fund non-Federal projects under grants and cooperative agreements when the award activities remain subject to Federal authority and control. Non-Federal entities are required to identify to the awarding agency any direct, indirect or cumulative impact an award will have on the quality of the human environment and assist the agency in complying with NEPA. Non-Federal entities may also be requested to assist DOC in drafting an environmental assessment or environmental impact statement if DOC determines such documentation is required, but DOC remains responsible for the sufficiency and approval of the final documentation. Until the appropriate NEPA documentation is complete and in the event that any additional information is required during the period of performance to assess project environmental impacts, funds can be withheld by the Grants Officer under a specific award condition requiring the non-Federal entity to submit the appropriate environmental information and NEPA documentation sufficient to enable DOC to make an assessment on any impacts that a project may have on the environment.

b. The National Historic Preservation Act (16 U.S.C. §§ 470 *et seq.*)

Section 106 of the National Historic Preservation Act (NHPA) (16 U.S.C. § 470f) and the Advisory Council on Historic Preservation (ACHP) implementing regulations (36 C.F.R. Part 800) require that Federal agencies take into account the effects of their undertakings on historic properties and, when appropriate, provide the ACHP with a reasonable opportunity to comment. Historic properties include but are not necessarily limited to districts, buildings, structures, sites and objects. In this connection, archeological resources and sites that may be of traditional religious and cultural importance to Federally-recognized Indian Tribes, Alaskan Native Villages and Native Hawaiian Organizations may be considered historic properties. Non-Federal entities are required to identify to the awarding agency any effects the award may have on properties included on or eligible for inclusion on the National Register of Historic Places. Non-Federal entities may also be requested to assist DOC in consulting with State or Tribal Historic Preservation Officers, ACHPs or other applicable interested parties necessary to identify, assess, and resolve adverse effects to historic properties. Until such time as the appropriate NHPA consultations and documentation are complete and in the event that any additional information is required during the period of performance in order to assess project impacts on historic properties, funds can be withheld by the Grants Officer under a specific award condition requiring the non-Federal entity to

submit any information sufficient to enable DOC to make the requisite assessment under the NHPA.

Additionally, non-Federal entities are required to assist the DOC in assuring compliance with the Archeological and Historic Preservation Act of 1974 (54 U.S.C. § 312502 *et seq.*, formerly 16 U.S.C. § 469a-1 *et seq.*); Executive Order 11593 (Protection and Enhancement of the Cultural Environment, May 13, 1971); Executive Order 13006 (Locating Federal Facilities on Historic Properties in Our Nation’s Central Cities, May 21, 1996); and Executive Order 13007 (Indian Sacred Sites, May 24, 1996).

c. Executive Order 11988 (Floodplain Management) and Executive Order 11990 (Protection of Wetlands)

Non-Federal entities must identify proposed actions in Federally defined floodplains and wetlands to enable DOC to decide whether there is an alternative to minimize any potential harm.

d. Clean Air Act (42 U.S.C. §§ 7401 *et seq.*), Federal Water Pollution Control Act (33 U.S.C. §§ 1251 *et seq.*) (Clean Water Act), and Executive Order 11738 (“Providing for administration of the Clean Air Act and the Federal Water Pollution Control Act with respect to Federal contracts, grants or loans”)

Non-Federal entities must comply with the provisions of the Clean Air Act (42 U.S.C. §§ 7401 *et seq.*), Clean Water Act (33 U.S.C. §§ 1251 *et seq.*), and E.O. 11738 (38 FR 25161), and must not use a facility on the Excluded Parties List (EPL) (located on the System for Award Management (SAM) website, SAM.gov) in performing any award that is nonexempt under 2 C.F.R. § 1532, and must notify the Program Officer in writing if it intends to use a facility that is on the EPL or knows that the facility has been recommended to be placed on the EPL.

e. The Flood Disaster Protection Act (42 U.S.C. §§ 4002 *et seq.*)

Flood insurance, when available, is required for Federally assisted construction or acquisition in flood-prone areas. Per 2 C.F.R. § 200.447(a), the cost of required flood insurance is an allowable expense, if it is reflected in the approved project budget.

f. The Endangered Species Act (16 U.S.C. §§ 1531 *et seq.*)

Non-Federal entities must identify any impact or activities that may involve a threatened or endangered species. Federal agencies have the responsibility to ensure that no adverse effects to a protected species or habitat occur from actions under Federal assistance awards and conduct the reviews required under the Endangered Species Act, as applicable.

g. The Coastal Zone Management Act (16 U.S.C. §§ 1451 *et seq.*)

Funded projects must be consistent with a coastal State’s approved management program for the coastal zone.

h. The Coastal Barriers Resources Act (16 U.S.C. §§ 3501 *et seq.*)

Only in certain circumstances can Federal funding be provided for actions within a Coastal Barrier System.

i. The Wild and Scenic Rivers Act (16 U.S.C. §§ 1271 *et seq.*)

This Act applies to awards that may affect existing or proposed components of the National Wild and Scenic Rivers system.

j. The Safe Drinking Water Act of 1974, as amended, (42 U.S.C. §§ 300f *et seq.*)

This Act precludes Federal assistance for any project that the EPA determines may contaminate a sole source aquifer which threatens public health.

k. The Resource Conservation and Recovery Act (42 U.S.C. §§ 6901 *et seq.*)

This Act regulates the generation, transportation, treatment, and disposal of hazardous wastes, and provides that non-Federal entities give preference in their procurement programs to the purchase of recycled products pursuant to EPA guidelines.

l. The Comprehensive Environmental Response, Compensation, and Liability Act (CERCLA, commonly known as Superfund) (42 U.S.C. §§ 9601 *et seq.*) and the Community Environmental Response Facilitation Act (42 U.S.C. § 9601 note *et seq.*)

These requirements address responsibilities related to hazardous substance releases, threatened releases and environmental cleanup. There are also reporting and community involvement requirements designed to ensure disclosure of the release or disposal of regulated substances and cleanup of hazards to state and local emergency responders.

m. Executive Order 12898 (“Federal Actions to Address Environmental Justice in Minority Populations and Low Income Populations”)

Federal agencies are required to identify and address the disproportionately high and adverse human health or environmental effects of Federal programs, policies, and activities on low income and minority populations.

n. The Magnuson-Stevens Fishery Conservation and Management Act (16 U.S.C. § 1801 *et seq.*)

Non-Federal entities must identify to DOC any effects the award may have on essential fish habitat (EFH). Federal agencies which fund, permit, or carry out activities that may adversely impact EFH are required to consult with the National Marine Fisheries Service (NMFS) regarding the potential effects of their actions and respond in writing to NMFS recommendations. These recommendations may include measures to avoid, minimize, mitigate, or otherwise offset adverse effects on EFH. In addition, NMFS is required to comment on any state agency activities that would impact EFH. Provided the specifications outlined in the regulations are met, EFH consultations will be incorporated into interagency

procedures previously established under NEPA, the ESA, Clean Water Act, Fish and Wildlife Coordination Act, or other applicable statutes.

o. Clean Water Act (CWA) Section 404 (33 U.S.C. § 1344)

CWA Section 404 regulates the discharge of dredged or fill material into waters of the United States, including wetlands. Activities in waters of the United States regulated under this program include fill for development, water resource projects (such as levees and some coastal restoration activities), and infrastructure development (such as highways and airports). CWA Section 404 requires a permit from the U.S. Army Corps of Engineers before dredged or fill material may be discharged into waters of the United States, unless the activity is exempt from Section 404 regulation (e.g., certain farming and forestry activities).

p. Rivers and Harbors Act (33 U.S.C. § 407)

A permit may be required from the U.S. Army Corps of Engineers if the proposed activity involves any work in, over or under navigable waters of the United States. Recipients must identify any work (including structures) that will occur in, over or under navigable waters of the United States and obtain the appropriate permit, if applicable.

q. The Migratory Bird Treaty Act (16 U.S.C. §§ 703-712), Bald and Golden Eagle Protection Act (16 U.S.C. § 668 *et seq.*), and Executive Order 13186 (Responsibilities of Federal Agencies to Protect Migratory Birds, January 10, 2001)

Many prohibitions and limitations apply to projects that adversely impact migratory birds and bald and golden eagles. Executive Order 13186 directs Federal agencies to enter a Memorandum of Understanding with the U.S. Fish and Wildlife Service to promote conservation of migratory bird populations when a Federal action will have a measurable negative impact on migratory birds.

r. Executive Order 13112 (Invasive Species, February 3, 1999)

Federal agencies must identify actions that may affect the status of invasive species and use relevant programs and authorities to: (i) prevent the introduction of invasive species; (ii) detect and respond rapidly to and control populations of such species in a cost-effective and environmentally sound manner; (iii) monitor invasive species populations accurately and reliably; (iv) provide for restoration of native species and habitat conditions in ecosystems that have been invaded; (v) conduct research on invasive species and develop technologies to prevent introduction and provide for environmentally sound control of invasive species; and (vi) promote public education on invasive species and the means to address them. In addition, an agency may not authorize, fund, or carry out actions that it believes are likely to cause or promote the introduction or spread of invasive species in the United States or elsewhere.

s. Fish and Wildlife Coordination Act (16 U.S.C. § 661 *et seq.*)

During the planning of water resource development projects, agencies are required to give fish and wildlife resources equal consideration with other values. Additionally, the U.S.

Fish and Wildlife Service and fish and wildlife agencies of states must be consulted whenever waters of any stream or other body of water are “proposed or authorized, permitted or licensed to be impounded, diverted... or otherwise controlled or modified” by any agency under a Federal permit or license.

.05 OTHER NATIONAL POLICY REQUIREMENTS

a. Buy-American Preferences

Strengthening Buy-American Preferences for Infrastructure Projects. Recipients of covered programs (as defined in Executive Order 13858, 31 January 2019, and 2 C.F.R. §200.322 (Domestic preferences for procurements)) are hereby notified that they are encouraged to use, to the greatest extent practicable, iron and aluminum as well as steel, cement, and other manufactured products produced in the United States in every contract, subcontract, purchase order, or subaward that is chargeable under this Award.

b. Criminal and Prohibited Activities

1. The Program Fraud Civil Remedies Act (31 U.S.C. § 3801 *et seq.*), provides for the imposition of civil penalties against persons who make false, fictitious, or fraudulent claims to the Federal Government for money (including money representing grants, loans, or other benefits).
2. The False Claims Amendments Act of 1986 and the False Statements Accountability Act of 1996 (18 U.S.C. §§ 287 and 1001, respectively), provide that whoever makes or presents any false, fictitious, or fraudulent statement, representation, or claim against the United States must be subject to imprisonment of not more than five years and must be subject to a fine in the amount provided by 18 U.S.C. § 287.
3. The Civil False Claims Act (31 U.S.C. §§ 3729 - 3733), provides that suits can be brought by the government, or a person on behalf of the government, for false claims made under Federal assistance programs.
4. The Copeland Anti-Kickback Act (18 U.S.C. § 874), prohibits a person or organization engaged in a Federally supported project from enticing an employee working on the project from giving up a part of his compensation under an employment contract. The Copeland Anti-Kickback Act also applies to contractors and subcontractors pursuant to 40 U.S.C. § 3145.
5. The Uniform Relocation Assistance and Real Property Acquisition Policies Act of 1970 (42 U.S.C. § 4601 *et seq.*) and implementing regulations issued at 15 C.F.R. Part 11, which provides for fair and equitable treatment of displaced persons or persons whose property is acquired as a result of Federal or Federally-assisted programs. These requirements apply to all interests in real property acquired for project purposes regardless of Federal participation in purchases.

6. The Hatch Act (5 U.S.C. §§ 1501-1508 and 7321-7326), which limits the political activities of employees or officers of state or local governments whose principal employment activities are funded in whole or in part with Federal funds.

7. To ensure compliance with Federal law pertaining to financial assistance awards, an authorized representative of a non-Federal entity may be required to periodically provide certain certifications to the DOC regarding Federal felony and Federal criminal tax convictions, unpaid federal tax assessments, delinquent Federal tax returns and such other certifications that may be required by Federal law.

c. Drug-Free Workplace

The non-Federal entity must comply with the provisions of the Drug-Free Workplace Act of 1988 (41 U.S.C. § 8102) and DOC implementing regulations published at 2 C.F.R. Part 1329 (Requirements for Drug-Free Workplace (Financial Assistance)), which require that the non-Federal entity take certain actions to provide a drug-free workplace.

d. Foreign Travel

1. Each non-Federal entity must comply with the provisions of the Fly America Act (49 U.S.C. § 40118). The implementing regulations of the Fly America Act are found at 41 C.F.R. §§ 301-10.131 through 301-10.143.

2. The Fly America Act requires that Federal travelers and others performing U.S. Government-financed air travel must use U.S. flag air carriers, to the extent that service by such carriers is available. Foreign air carriers may be used only in specific instances, such as when a U.S. flag air carrier is unavailable or use of U.S. flag air carrier service will not accomplish the agency's mission.

3. One exception to the requirement to fly U.S. flag carriers is transportation provided under a bilateral or multilateral air transport agreement, to which the United States Government and the government of a foreign country are parties, and which the Department of Transportation has determined meets the requirements of the Fly America Act pursuant to 49 U.S.C. § 40118(b). The United States Government has entered into bilateral/multilateral "Open Skies Agreements" (U.S. Government Procured Transportation) that allow federal funded transportation services for travel and cargo movements to use foreign air carriers under certain circumstances. There are multiple "Open Skies Agreements" currently in effect. For more information about the current bilateral and multilateral agreements, visit the GSA [website](#). Information on the Open Skies agreements (U.S. Government Procured Transportation) and other specific country agreements may be accessed via the Department of State's [website](#).

4. If a foreign air carrier is anticipated to be used for any portion of travel under a DOC financial assistance award, the non-Federal entity must receive prior approval from the Grants Officer. When requesting such approval, the non-Federal entity must provide a justification in accordance with guidance provided by 41 C.F.R. § 301-10.142, which requires the non-Federal entity to provide the Grants Officer with the following: name; dates

of travel; origin and destination of travel; detailed itinerary of travel; name of the air carrier and flight number for each leg of the trip; and a statement explaining why the non-Federal entity meets one of the exceptions to the regulations. If the use of a foreign air carrier is pursuant to a bilateral agreement, the non-Federal entity must provide the Grants Officer with a copy of the agreement or a citation to the official agreement available on the GSA website. The Grants Officer must make the final determination and notify the non-Federal entity in writing (which may be done through the recipient in the case of subrecipient travel). Failure to adhere to the provisions of the Fly America Act will result in the non-Federal entity not being reimbursed for any transportation costs for which any non-Federal entity improperly used a foreign air carrier.

Note: When using code-sharing flights (two or more airlines having flight numbers assigned to the same flight) involving U.S. flag carriers and non-U.S. flag carriers, the airline symbol and flight number of the U.S. flag carrier must be used on the ticket to qualify as a U.S. flag carrier (e.g. "*Delta Airlines Flight XXXX, operated by KLM*"). Conversely, if the ticket shows "[*Foreign Air Carrier*] XXX, operated by Delta," that travel is using a foreign air carrier and is subject to the Fly America Act and must receive prior approval from the Grants Officer as outlined in paragraph G.05.d.4.

e. Increasing Seat Belt Use in the United States

Pursuant to E.O. 13043 (62 FR 19217), non-Federal entities should encourage employees and contractors to enforce on-the-job seat belt policies and programs when operating company-owned, rented, or personally owned vehicles.

f. Federal Employee Expenses and Subawards or Contracts Issued to Federal Employees or Agencies

1. Use of award funds (Federal or non-Federal) or the non-Federal entity's provision of in-kind goods or services for the purposes of transportation, travel, or any other expenses for any Federal employee may raise appropriation augmentation issues. In addition, DOC policy may prohibit the acceptance of gifts, including travel payments for federal employees, from non-Federal entities regardless of the source. Therefore, before award funds may be used by Federal employees, non-Federal entities must submit requests for approval of such action to the Federal Program Officer who must review and make a recommendation to the Grants Officer. The Grants Officer will notify the non-Federal entity in writing (generally through the recipient) of the final determination.
2. A non-Federal entity or its contractor may not issue a subaward, contract or subcontract of any part of a DOC award to any agency or employee of DOC or to other Federal employee, department, agency, or instrumentality, without the advance prior written approval of the DOC Grants Officer.

g. Minority Serving Institutions Initiative

Pursuant to E.O.s 13555 (White House Initiative on Educational Excellence for Hispanics) (75 FR 65417), 13592 (Improving American Indian and Alaska Native

Educational Opportunities and Strengthening Tribal Colleges and Universities) (76 FR 76603), and 13779 (White House Initiative to Promote Excellence and Innovation at Historically Black Colleges and Universities) (82 FR 12499), DOC is strongly committed to broadening the participation of minority serving institutions (MSIs) in its financial assistance programs. DOC's goals include achieving full participation of MSIs to advance the development of human potential, strengthen the Nation's capacity to provide high-quality education, and increase opportunities for MSIs to participate in and benefit from Federal financial assistance programs. DOC encourages all applicants and non-Federal entities to include meaningful participation of MSIs. Institutions eligible to be considered MSIs are listed on the Department of Education website.

h. Research Misconduct

The DOC adopts, and applies to financial assistance awards for research, the Federal Policy on Research Misconduct (Federal Policy) issued by the Executive Office of the President's Office of Science and Technology Policy on December 6, 2000 (65 FR 76260). As provided for in the Federal Policy, research misconduct refers to the fabrication, falsification, or plagiarism in proposing, performing, or reviewing research, or in reporting research results. Research misconduct does not include honest errors or differences of opinion. Non-Federal entities that conduct extramural research funded by DOC must foster an atmosphere conducive to the responsible conduct of sponsored research by safeguarding against and resolving allegations of research misconduct. Non-Federal entities also have the primary responsibility to prevent, detect, and investigate allegations of research misconduct and, for this purpose, may rely on their internal policies and procedures, as appropriate, to do so. Non-Federal entities must notify the Grants Officer of any allegation that meets the definition of research misconduct and detail the entity's inquiry to determine whether there is sufficient evidence to proceed with an investigation, as well as the results of any investigation. The DOC may take appropriate administrative or enforcement action at any time under the award, up to and including award termination and possible suspension or debarment, and referral to the Commerce OIG, the U.S. Department of Justice, or other appropriate investigative body.

i. Research Involving Human Subjects

1. All proposed research involving human subjects must be conducted in accordance with 15 C.F.R. Part 27 (Protection of Human Subjects). No research involving human subjects is permitted under this award unless expressly authorized by specific award condition, or otherwise in writing by the Grants Officer.
2. Federal policy defines a human subject as a living individual about whom an investigator (whether professional or student) conducting research (1) Obtains information or biospecimens through intervention or interaction with the individual, and uses, studies, or analyzes the information or biospecimens; or (2) Obtains, uses, studies, analyzes, or generates identifiable private information or identifiable biospecimens. Research means a systematic investigation, including research development, testing and evaluation, designed to develop or contribute to generalizable knowledge.

3. DOC regulations at 15 C.F.R. Part 27 require that non-Federal entities maintain appropriate policies and procedures for the protection of human subjects. In the event it becomes evident that human subjects may be involved in this project, the non-Federal entity (generally through the recipient) must submit appropriate documentation to the Federal Program Officer for approval by the appropriate DOC officials. As applicable, this documentation must include:

- i. Documentation establishing approval of an activity in the project by an Institutional Review Board (IRB) under a Federal wide Assurance issued by Department of Health and Human Services or other Federal agency guidelines (*see also* 15 C.F.R. § 27.103);
- ii. Documentation to support an exemption for an activity in the project under 15 C.F.R. § 27.104(d);
- iii. Documentation of IRB approval of any modification to a prior approved protocol or to an informed consent form;
- iv. Documentation of an IRB approval of continuing review approved prior to the expiration date of the previous IRB determination; and
- v. Documentation of any reportable events, such as serious adverse events, unanticipated problems resulting in risk to subjects or others, and instances of noncompliance.

4. No work involving human subjects may be undertaken, conducted, or costs incurred and/or charged for human subjects research, until the appropriate documentation is approved in writing by the Grants Officer. In accordance with 15 C.F.R. § 27.118, if research involving human subjects is proposed after an award is made, the non-Federal entity must contact the Federal Program Officer and provide required documentation. Notwithstanding this prohibition, work may be initiated or costs incurred and/or charged to the project for protocol or instrument development related to human subjects research.

j. Care and Use of Live Vertebrate Animals

Non-Federal entities must comply with the Laboratory Animal Welfare Act of 1966, as amended, (Pub. L. No. 89-544, 7 U.S.C. §§ 2131 *et seq.*) (animal acquisition, transport, care, handling, and use in projects), and implementing regulations (9 C.F.R. Parts 1, 2, and 3); the Endangered Species Act (16 U.S.C. §§ 1531 *et seq.*); Marine Mammal Protection Act (16 U.S.C. §§ 1361 *et seq.*) (taking possession, transport, purchase, sale, export or import of wildlife and plants); the Nonindigenous Aquatic Nuisance Prevention and Control Act (16 U.S.C. §§ 4701 *et seq.*) (ensure preventive measures are taken or that probable harm of using species is minimal if there is an escape or release); and all other applicable statutes pertaining to the care, handling, and treatment of warm-blooded animals held for research, teaching, or other activities supported by Federal financial assistance. No research involving vertebrate animals is permitted under any DOC financial assistance award unless authorized by the Grants Officer.

k. Management and Access to Data and Publications

1. In General. The recipient acknowledges and understands that information and data contained in applications for financial assistance, as well as information and data contained in financial, performance and other reports submitted by recipients, may be used by the DOC in conducting reviews and evaluations of its financial assistance programs. For this purpose, recipient information and data may be accessed, reviewed and evaluated by DOC employees, other Federal employees, Federal agents and contractors, and/or by non-Federal personnel, all of who enter into appropriate or are otherwise subject to confidentiality and nondisclosure agreements covering the use of such information. Recipients are expected to support program reviews and evaluations by submitting required financial and performance information and data in an accurate and timely manner, and by cooperating with DOC and external program evaluators. In accordance with 2 C.F.R. § 200.303(e), recipients are reminded that they must take reasonable measures to safeguard protected personally identifiable information and other confidential or sensitive personal or business information created or obtained relating to a DOC financial assistance award.
2. Scientific Data. Non-Federal entities must comply with the data management and access to data requirements established by the DOC funding agency as set forth in the applicable Notice of Funding Opportunity and/or in Specific Award Conditions.
3. Publications, Videos, and Acknowledgment of Sponsorship.
 - i. Publication of results or findings in appropriate professional journals and production of video or other media is encouraged as an important method of recording, reporting and otherwise disseminating information and expanding public access to federally-funded projects (*e.g.*, scientific research). Non-Federal entities must comply with the data management and access to data requirements established by the DOC funding agency as set forth in the applicable Notice of Funding Opportunity and/or in Specific Award Conditions.
 - ii. Non-Federal entities may be required to submit a copy of any publication materials, including but not limited to print, recorded, or Internet materials, to the funding agency.
 - iii. When releasing information related to a funded project, non-Federal entities must include a statement that the project or effort undertaken was or is sponsored by DOC and must also include the applicable financial assistance award number.
 - iv. Non-Federal entities are responsible for assuring that every publication of material based on, developed under, or otherwise produced pursuant to a DOC financial assistance award contains the following disclaimer or other disclaimer approved by the Grants Officer:

This [report/video/etc.] was prepared by [recipient name] using Federal funds under award [number] from [name of operating unit], U.S. Department of Commerce. The statements, findings, conclusions, and recommendations are those of the author(s) and do

not necessarily reflect the views of the [name of operating unit] or the U.S. Department of Commerce.

I. Homeland Security Presidential Directive

If the performance of this DOC financial assistance award requires non-Federal entity personnel to have routine access to Federally-controlled facilities and/or Federally-controlled information systems (for purpose of this term “routine access” is defined as more than 180 calendar days), such personnel must undergo the personal identity verification credential process. In the case of foreign nationals, the DOC will conduct a check with U.S. Citizenship and Immigration Services’ (USCIS) Verification Division, a component of the Department of Homeland Security (DHS), to ensure the individual is in a lawful immigration status and that he or she is eligible for employment within the United States. Any items or services delivered under a financial assistance award must comply with DOC personal identity verification procedures that implement Homeland Security Presidential Directive 12 (Policy for a Common Identification Standard for Federal Employees and Contractors), Federal Information Processing Standard (FIPS) PUB 201, and OMB Memorandum M-05-24. The recipient must ensure that its subrecipients and contractors (at all tiers) performing work under this award comply with the requirements contained in this term. The Grants Officer may delay final payment under an award if the subrecipient or contractor fails to comply with the requirements listed in the term below. The recipient must insert the following term in all subawards and contracts when the subaward recipient or contractor is required to have routine physical access to a Federally-controlled facility or routine access to a Federally-controlled information system:

The subrecipient or contractor must comply with DOC personal identity verification procedures identified in the subaward or contract that implement Homeland Security Presidential Directive 12 (HSPD-12), Office of Management and Budget (OMB) Guidance M-05-24, as amended, and Federal Information Processing Standards Publication (FIPS PUB) Number 201, as amended, for all employees under this subaward or contract who require routine physical access to a Federally-controlled facility or routine access to a Federally-controlled information system.

The subrecipient or contractor must account for all forms of Government-provided identification issued to the subrecipient or contractor employees in connection with performance under this subaward or contract. The subrecipient or contractor must return such identification to the issuing agency at the earliest of any of the following, unless otherwise determined by DOC: (1) When no longer needed for subaward or contract performance; (2) Upon completion of the subrecipient or contractor employee’s employment; (3) Upon subaward or contract completion or termination.

m. Compliance with Department of Commerce Bureau of Industry and Security Export Administration Regulations

1. This clause applies to the extent that this financial assistance award encompasses activities that involve export-controlled items.

2. In performing this financial assistance award, a non-Federal entity may participate in activities involving items subject to export control (export-controlled items) under the Export Administration Regulations (EAR). The non-Federal entity is responsible for compliance with all applicable laws and regulations regarding export-controlled items, including the EAR's deemed exports and re-exports provisions. The non-Federal entity must establish and maintain effective export compliance procedures at DOC and non-DOC facilities, including facilities located abroad, throughout performance of the financial assistance award. At a minimum, these export compliance procedures must include adequate restrictions on export-controlled items, to guard against any unauthorized exports, including in the form of releases or transfers to foreign nationals. Such releases or transfers may occur through visual inspection, including technology transmitted electronically, and oral or written communications.

3. Definitions

- i. Export-controlled items. Items (commodities, software, or technology), that are subject to the EAR (15 C.F.R. §§ 730-774), implemented by the DOC's Bureau of Industry and Security. These are generally known as "dual-use" items, items with a military and commercial application. The export (shipment, transmission, or release/transfer) of export-controlled items may require a license from DOC.
- ii. Deemed Export/Re-export. The EAR defines a deemed export as a release or transfer of export-controlled items (specifically, technology or source code) to a foreign person (foreign national) in the U.S. Such release is "deemed" to be an export to the foreign person's most recent country of citizenship or permanent residency (*see* 15 C.F.R. § 734.13(a)(2) & (b)). A release may take the form of visual inspection or oral or written exchange of information. *See* 15 C.F.R. § 734.15(a). If such a release or transfer is made abroad to a foreign person of a country other than the country where the release occurs, it is considered a deemed re-export to the foreign person's most recent country of citizenship or permanent residency. *See* 15 C.F.R. § 734.14(a)(2). Licenses from DOC may be required for deemed exports or re-exports. An act causing the release of export-controlled items to a foreign person (e.g., providing or using an access key or code) may require authorization from DOC to the same extent that an export or re-export of such items to the foreign person would. *See* 15 C.F.R. § 734.15(b).

4. The non-Federal entity must secure all export-controlled items that it possesses or that comes into its possession in performance of this financial assistance award, to ensure that the export of such items, including in the form of release or transfer to foreign persons, is prevented, or licensed, as required by applicable Federal laws, E.O.s, and/or regulations, including the EAR.

5. As applicable, non-Federal entity personnel and associates at DOC sites will be informed of any procedures to identify and protect export-controlled items from unauthorized export.

6. To the extent the non-Federal entity wishes to release or transfer export-controlled items to foreign persons, the non-Federal entity will be responsible for obtaining any necessary licenses, including licenses required under the EAR for deemed exports or deemed re-exports. Failure to obtain any export licenses required under the EAR may subject the non-Federal entity to administrative or criminal enforcement. See 15 C.F.R. part 764.
7. Nothing in the terms of this financial assistance award is intended to change, supersede, or waive the requirements of applicable Federal laws, E.O.s or regulations.
8. Compliance with this term will not satisfy any legal obligations the non-Federal entity may have regarding items that may be subject to export controls administered by other agencies such as the Department of State, which has jurisdiction over exports and re-exports of defense articles and services subject to the International Traffic in Arms Regulations (ITAR) (22 C.F.R. §§ 120-130), including the release of defense articles to foreign persons in the United States and abroad.
9. The non-Federal entity must include the provisions contained in this term in all lower tier transactions (subawards, contracts, and subcontracts) under this financial assistance award that may involve research or other activities that implicate export-controlled items.

n. The Trafficking Victims Protection Act of 2000 (22 U.S.C. § 7104(g)), as amended, and the implementing regulations at 2 C.F.R. Part 175

The Trafficking Victims Protection Act of 2000 authorizes termination of financial assistance provided to a private entity, without penalty to the Federal Government, if any non-Federal entity engages in certain activities related to trafficking in persons. The DOC hereby incorporates the following award term required by 2 C.F.R. § 175.15(b):

Trafficking in persons.

a. Provisions applicable to a recipient that is a private entity.

1. You as the recipient, your employees, subrecipients under this award, and subrecipients' employees may not—

- i. Engage in severe forms of trafficking in persons during the period of time that the award is in effect;*
- ii. Procure a commercial sex act during the period of time that the award is in effect; or*
- iii. Use forced labor in the performance of the award or subawards under the award.*

2. *We as the Federal awarding agency may unilaterally terminate this award, without penalty, if you or a subrecipient that is a private entity —*

i. *Is determined to have violated a prohibition in paragraph a.1 of this award term; or*

ii. *Has an employee who is determined by the agency official authorized to terminate the award to have violated a prohibition in paragraph a.1 of this award term through conduct that is either— (A) Associated with performance under this award; or (B) Imputed to you or the subrecipient using the standards and due process for imputing the conduct of an individual to an organization that are provided in 2 C.F.R. Part 180 (OMB Guidelines to Agencies on Governmentwide Debarment and Suspension – Nonprocurement), as implemented by DOC at 2 C.F.R. Part 1326 (Nonprocurement Debarment and Suspension).*

b. Provision applicable to a recipient other than a private entity. *We as the Federal awarding agency may unilaterally terminate this award, without penalty, if a subrecipient that is a private entity—*

1. *Is determined to have violated an applicable prohibition in paragraph a.1 of this award term; or*

2. *Has an employee who is determined by the agency official authorized to terminate the award to have violated an applicable prohibition in paragraph a.1 of this award term through conduct that is either—*

i. *Associated with performance under this award; or*

ii. *Imputed to the subrecipient using the standards and due process for imputing the conduct of an individual to an organization that are provided in 2 C.F.R. Part 180 (OMB Guidelines to Agencies on Governmentwide Debarment and Suspension – Nonprocurement), as implemented by DOC at 2 C.F.R. Part 1326, (Nonprocurement Debarment and Suspension).*

c. Provisions applicable to any recipient.

1. *You must inform us immediately of any information you receive from any source alleging a violation of a prohibition in paragraph a.1 of this award term.*

2. *Our right to terminate unilaterally that is described in paragraph a.2 or b of this section:*

i. *Implements section 106(g) of the Trafficking Victims Protection Act of 2000 (TVPA), as amended (22 U.S.C. 7104(g)), and*

ii. *Is in addition to all other remedies for noncompliance that are available to us under this award.*

3. You must include the requirements of paragraph a.1 of this award term in any subaward you make to a private entity.

d. Definitions. For purposes of this award term:

1. “Employee” means either:

i. An individual employed by you or a subrecipient who is engaged in the performance of the project or program under this award; or

ii. Another person engaged in the performance of the project or program under this award and not compensated by you including, but not limited to, a volunteer or individual whose services are contributed by a third party as an in-kind contribution toward cost sharing or matching requirements.

2. “Forced labor” means labor obtained by any of the following methods: the recruitment, harboring, transportation, provision, or obtaining of a person for labor or services, through the use of force, fraud, or coercion for the purpose of subjection to involuntary servitude, peonage, debt bondage, or slavery.

3. “Private entity”:

i. Means any entity other than a State, local government, Indian tribe, or foreign public entity, as those terms are defined in 2 C.F.R. § 175.25;

ii. Includes: (A) A nonprofit organization, including any nonprofit institution of higher education, hospital, or tribal organization other than one included in the definition of Indian tribe at 2 C.F.R. § 175.25(b); and (B) A for-profit organization.

4. “Severe forms of trafficking in persons,” “commercial sex act,” and “coercion” have the meanings given at section 103 of the TVPA, as amended (22 U.S.C. § 7102).

o. The Federal Funding Accountability and Transparency Act (FFATA) (31 U.S.C. § 6101 note)

1. **Reporting Subawards and Executive Compensation.** Under FFATA, recipients of financial assistance awards of \$30,000 or more are required to report periodically on executive compensation and subawards, as described in the following term from 2 C.F.R. Part 170, Appendix A, which is incorporated into this award:

Reporting Subawards and Executive Compensation

a. Reporting of first-tier subawards.

1. *Applicability.* Unless you are exempt as provided in paragraph d. of this award term, you must report each action that equals or exceeds \$30,000 in Federal funds for a subaward

to a non-Federal entity or Federal agency (see definitions in paragraph e. of this award term).

2. *Where and when to report.*

i. *You must report each obligating action described in paragraph a.1. of this award term to <http://www.fsrs.gov>.*

ii. *For subaward information, report no later than the end of the month following the month in which the obligation was made. (For example, if the obligation was made on November 7, 2010, the obligation must be reported by no later than December 31, 2010.)*

3. *What to report. You must report the information about each obligating action that the submission instructions posted at <http://www.fsrs.gov> specify.*

b. *Reporting Total Compensation of Recipient Executives for non-Federal entities.*

1. *Applicability and what to report. You must report total compensation for each of your five most highly compensated executives for the preceding completed fiscal year, if—*

i. *the total Federal funding authorized to date under this Federal award equals or exceeds \$30,000 as defined in 2 C.F.R § 170.320;*

ii. *in the preceding fiscal year, you received—*

(A) *80 percent or more of your annual gross revenues from Federal procurement contracts (and subcontracts) and Federal financial assistance subject to the Transparency Act, as defined at 2 C.F.R. § 170.320 (and subawards), and*

(B) *\$25,000,000 or more in annual gross revenues from Federal procurement contracts (and subcontracts) and Federal financial assistance subject to the Transparency Act, as defined at 2 C.F.R. § 170.320 (and subawards); and,*

iii. *The public does not have access to information about the compensation of the executives through periodic reports filed under section 13(a) or 15(d) of the Securities Exchange Act of 1934 (15 U.S.C. § 78m(a), 78o(d)) or section 6104 of the Internal Revenue Code of 1986. (To determine if the public has access to the compensation information, see the U.S. Security and Exchange Commission total compensation filings at <http://www.sec.gov/answers/execomp.htm>.)*

2. *Where and when to report. You must report executive total compensation described in paragraph b.1. of this award term:*

i. *As part of your registration profile found at the System for Award Management (SAM) website located at <https://www.sam.gov>.*

ii. *By the end of the month following the month in which this award is made, and annually thereafter.*

c. Reporting of Total Compensation of Subrecipient Executives.

1. *Applicability and what to report. Unless you are exempt as provided in paragraph d. of this award term, for each first-tier non-Federal entity subrecipient under this award, you shall report the names and total compensation of each of the subrecipient's five most highly compensated executives for the subrecipient's preceding completed fiscal year, if—*

i. *in the subrecipient's preceding fiscal year, the subrecipient received—*

(A) *80 percent or more of its annual gross revenues from Federal procurement contracts (and subcontracts) and Federal financial assistance subject to the Transparency Act, as defined at 2 C.F.R. § 170.320 (and subawards) and,*

(B) *\$25,000,000 or more in annual gross revenues from Federal procurement contracts (and subcontracts), and Federal financial assistance subject to the Transparency Act (and subawards); and*

ii. *The public does not have access to information about the compensation of the executives through periodic reports filed under section 13(a) or 15(d) of the Securities Exchange Act of 1934 (15 U.S.C. 78m(a), 78o(d)) or section 6104 of the Internal Revenue Code of 1986. (To determine if the public has access to the compensation information, see the U.S. Security and Exchange Commission total compensation filings at <http://www.sec.gov/answers/execomp.htm>).*

See also 2 C.F.R. § 200.300(b).

2. *Where and when to report. You must report subrecipient executive total compensation described in paragraph c.1. of this award term:*

i. *To the recipient.*

ii. *By the end of the month following the month during which you make the subaward. For example, if a subaward is obligated on any date during the month of October of a given year (i.e., between October 1 and 31), you must report any required compensation information of the subrecipient by November 30 of that year.*

d. Exemptions. *If, in the previous tax year, you had gross income, from all sources, under \$300,000, you are exempt from the requirements to report: i. Subawards, and ii. The total compensation of the five most highly compensated executives of any subrecipient.*

e. Definitions. For purposes of this award term:

- 1. Federal Agency means a Federal agency as defined at 5 U.S.C. 551(1) and further clarified by 5 U.S.C. 552(f).*
- 2. Non-Federal entity means all of the following, as defined in 2 C.F.R. Part 25:
 - i. A Governmental organization, which is a State, local government, or Indian tribe;*
 - ii. A foreign public entity;*
 - iii. A domestic or foreign nonprofit organization; and,*
 - iv. A domestic or foreign for-profit organization.**
- 3. Executive means officers, managing partners, or any other employees in management positions.*
- 4. Subaward:
 - i. This term means a legal instrument to provide support for the performance of any portion of the substantive project or program for which you received this award and that you as the recipient award to an eligible subrecipient.*
 - ii. The term does not include your procurement of property and services needed to carry out the project or program (for further explanation, see 2 C.F.R § 200.331).*
 - iii. A subaward may be provided through any legal agreement, including an agreement that you or a subrecipient considers a contract.**
- 5. Subrecipient means a non-Federal entity or Federal agency that:
 - i. Receives a subaward from you (the recipient) under this award; and*
 - ii. Is accountable to you for the use of the Federal funds provided by the subaward.**
- 6. Total compensation means the cash and noncash dollar value earned by the executive during the recipient's or subrecipient's preceding fiscal year and includes the following (for more information see 17 C.F.R. § 229.402(c)(2)):
 - i. Salary and bonus.*
 - ii. Awards of stock, stock options, and stock appreciation rights. Use the dollar amount recognized for financial statement reporting purposes with respect to the fiscal year in accordance with the Statement of Financial Accounting Standards No. 123 (Revised 2004) (FAS 123R), Shared Based Payments.**

- iii. *Earnings for services under non-equity incentive plans. This does not include group life, health, hospitalization or medical reimbursement plans that do not discriminate in favor of executives, and are available generally to all salaried employees.*
- iv. *Change in pension value. This is the change in present value of defined benefit and actuarial pension plans.*
- v. *Above-market earnings on deferred compensation which is not tax-qualified.*
- vi. *Other compensation, if the aggregate value of all such other compensation (e.g. severance, termination payments, value of life insurance paid on behalf of the employee, perquisites or property) for the executive exceeds \$10,000.*

2. **System for Award Management (SAM) and Universal Identifier Requirements** -- as described in 2 C.F.R. Part 25, Appendix A, which is incorporated into this award:

System for Award Management (SAM) and Universal Identifier Requirements

a. ***Requirement for System for Award Management.*** *Unless you are exempted from this requirement under 2 C.F.R. § 25.110, you as the recipient must maintain current information in the SAM. This includes information on your immediate and highest level owner and subsidiaries, as well as on all of your predecessors that have been awarded a Federal contract or Federal financial assistance within the last three years, if applicable, until you submit the final financial report required under this Federal award or receive the final payment, whichever is later. This requires that you review and update the information at least annually after the initial registration, and more frequently if required by changes in your information or another Federal award term.*

b. ***Requirement for Unique Entity Identifier.*** *If you are authorized to make subawards under this Federal award, you:*

- 1. *Must notify potential subrecipients that no entity (see definition in paragraph c of this award term) may receive a subaward from you until the entity has provided its Unique Entity Identifier to you.*
- 2. *May not make a subaward to an entity unless the entity has provided its Unique Entity Identifier to you. Subrecipients are not required to obtain an active SAM registration, but must obtain a Unique Entity Identifier.*

c. ***Definitions for purposes of this term:***

- 1. *SAM means the Federal repository into which a recipient must provide information required for the conduct of business as a recipient. Additional information about registration procedures may be found at the SAM Internet site (currently at <https://www.SAM.gov>).*

2. *Unique Entity Identifier means the identifier assigned by SAM to uniquely identify business entities.*
3. *Entity includes non-Federal entities as defined at 2 C.F.R. § 200.1 and also includes all of the following, for purposes of this part:*
 - i. *A foreign organization;*
 - ii. *A foreign public entity;*
 - iii. *A domestic for-profit organization; and*
 - iv. *A Federal agency.*
4. *Subaward has the meaning given in 2 C.F.R § 200.1.*
5. *Subrecipient has the meaning given in 2 C.F.R § 200.1.*

See also 2 C.F.R. § 200.300(b).

p. Recipient Integrity and Performance Matters (Appendix XII to 2 C.F.R. Part 200)

Reporting of Matters Related to Recipient Integrity and Performance

1. **General Reporting Requirement.** If the total value of your currently active grants, cooperative agreements, and procurement contracts from all Federal awarding agencies exceeds \$10,000,000 for any period of time during the period of performance of this Federal award, then you as the recipient during that period of time must maintain the currency of information reported to the System for Award Management (SAM) that is made available in the designated integrity and performance system (currently the Federal Awardee Performance and Integrity Information System (FAPIIS)) about civil, criminal, or administrative proceedings described in paragraph 2 of this award term and condition. This is a statutory requirement under section 872 of Public Law 110-417, as amended (41 U.S.C. 2313). As required by section 3010 of Public Law 111-212, all information posted in the designated integrity and performance system on or after April 15, 2011, except past performance reviews required for Federal procurement contracts, will be publicly available.
2. **Proceedings About Which You Must Report.** Submit the information required about each proceeding that:
 - i. Is relating to the award or performance of a grant, cooperative agreement, or procurement contract from the Federal Government;
 - ii. Reached its final disposition during the most recent five-year period; and

iii. Is one of the following:

- (A) A criminal proceeding that resulted in a conviction, as defined in paragraph 5 of this award term and condition;
- (B) A civil proceeding that resulted in a finding of fault and liability and payment of a monetary fine, penalty, reimbursement, restitution, or damages of \$5,000 or more;
- (C) An administrative proceeding, as defined in paragraph 5 of this award term and condition, that resulted in a finding of fault and liability and your payment of either a monetary fine or penalty of \$5,000 or more or reimbursement, restitution, or damages in excess of \$100,000; or
- (D) Any other criminal, civil, or administrative proceeding if:
 - I. It could have led to an outcome described in paragraph 2.c.(1), (2), or (3) of this award term and condition;
 - II. It had a different disposition arrived at by consent or compromise with an acknowledgment of fault on your part; and
 - III. The requirement in this award term and condition to disclose information about the proceeding does not conflict with applicable laws and regulations.

3. Reporting Procedures. Enter in the SAM Entity Management area the information that SAM requires about each proceeding described in paragraph 2 of this award term and condition. You do not need to submit the information a second time under assistance awards that you received if you already provided the information through SAM because you were required to do so under Federal procurement contracts that you were awarded.

4. Reporting Frequency. During any period when you are subject to the requirement in paragraph 1 of this award term and condition, you must report proceedings information through SAM for the most recent five-year period, either to report new information about any proceeding(s) that you have not reported previously or affirm that there is no new information to report. Recipients that have Federal contract, grant, and cooperative agreement awards with a cumulative total value greater than \$10,000,000 must disclose semiannually any information about the criminal, civil, and administrative proceedings.

5. Definitions. For purposes of this award term and condition:

- i. Administrative proceeding means a non-judicial process that is adjudicatory in nature to make a determination of fault or liability (e.g., Securities and Exchange Commission Administrative proceedings, Civilian Board of Contract Appeals proceedings, and Armed Services Board of Contract Appeals proceedings). This includes proceedings at the Federal and State level but only in connection with performance of a Federal contract or grant. It does not include audits, site visits, corrective plans, or inspection of deliverables.

ii. Conviction, for purposes of this award term and condition, means a judgment or conviction of a criminal offense by any court of competent jurisdiction, whether entered upon a verdict or a plea, and includes a conviction entered upon a plea of nolo contendere.

iii. Total value of currently active grants, cooperative agreements, and procurement contracts includes:

(A) Only the Federal share of the funding under any Federal award with a recipient cost share or match; and

(B) The value of all expected funding increments under a Federal award and options, even if not yet exercised.

q. Never Contract with the Enemy (2 C.F.R Part 183; 2 C.F.R. § 200.215)

Under 2 C.F.R. § 200.215 (Never contract with the enemy) Federal awarding agencies and recipients are subject to the regulations implementing Never Contract with the Enemy in 2 C.F.R. Part 183. These regulations affect covered contracts, grants and cooperative agreements that are expected to exceed \$50,000 within the period of performance, are performed outside the United States and its territories, and are in support of a contingency operation in which members of the Armed Forces are actively engaged in hostilities.

1. **Applicability.** This term applies only to recipients of covered grants or cooperative agreements, as defined in 2 C.F.R. § 183.35 Definitions.

2. **Requirements.** As applicable, recipients must fulfill the requirements as described in the following terms from 2 C.F.R. Part 183, Appendix A, which is incorporated into this award:

a. Term 1. Prohibition on Providing Funds to the Enemy.

1. *The recipient must—*

i. *Exercise due diligence to ensure that none of the funds, including supplies and services, received under this grant or cooperative agreement are provided directly or indirectly (including through subawards or contracts) to a person or entity who is actively opposing the United States or coalition forces involved in a contingency operation in which members of the Armed Forces are actively engaged in hostilities, which must be completed through 2 CFR Part 180.300 prior to issuing a subaward or contract and;*

ii. *Terminate or void in whole or in part any subaward or contract with a person or entity listed in SAM as a prohibited or restricted source pursuant to subtitle E of Title VIII of the NDAA for FY 2015, unless the Federal awarding agency provides written approval to continue the subaward or contract.*

2. *The recipient may include the substance of this clause, including this paragraph (1), in subawards under this grant or cooperative agreement that have an estimated value over \$50,000 and will be performed outside the United States, including its outlying areas.*

3. *The Federal awarding agency has the authority to terminate or void this grant or cooperative agreement, in whole or in part, if the Federal awarding agency becomes aware that the recipient failed to exercise due diligence as required by paragraph (1) of this clause or if the Federal awarding agency becomes aware that any funds received under this grant or cooperative agreement have been provided directly or indirectly to a person or entity who is actively opposing coalition forces involved in a contingency operation in which members of the Armed Forces are actively engaged in hostilities*

b. Term 2. Additional Access to Recipient Records.

1. *In addition to any other existing examination-of-records authority, the Federal Government is authorized to examine any records of the recipient and its subawards or contracts to the extent necessary to ensure that funds, including supplies and services, available under this grant or cooperative agreement are not provided, directly or indirectly, to a person or entity that is actively opposing United States or coalition forces involved in a contingency operation in which members of the Armed Forces are actively engaged in hostilities, except for awards awarded by the Department of Defense on or before Dec 19, 2017 that will be performed in the United States Central Command (USCENTCOM) theater of operations*

2. *The substance of this clause, including this paragraph (2), is required to be included in subawards or contracts under this grant or cooperative agreement that have an estimated value over \$50,000 and will be performed outside the United States, including its outlying areas.*

r. Prohibition on certain telecommunications and video surveillance services or equipment (Public Law 115-232, section 889; 2 C.F.R. § 200.216)

(a) Recipients and subrecipients are prohibited from obligating or expending loan or grant funds to:

- (1) Procure or obtain,
- (2) Extend or renew a contract to procure or obtain, or
- (3) Enter into a contract (or extend or renew a contract) to procure or obtain equipment, services or systems that uses covered telecommunications equipment or services as a substantial or essential component of any system, or as critical technology as part of any system.

As described in Public Law 115-232, section 889, covered telecommunications equipment is telecommunications equipment produced by Huawei Technologies Company or ZTE Corporation (or any subsidiary or affiliate of such entities).

- (i). For the purpose of public safety, security of government facilities, physical security surveillance of critical infrastructure, and other national security purposes, video surveillance and telecommunications equipment produced by Hytera Communications Corporation, Hangzhou Hikvision Digital Technology Company, or Dahua Technology Company (or any subsidiary or affiliate of such entities).
- (ii). Telecommunications or video surveillance services provided by such entities or using such equipment.
- (iii). Telecommunications or video surveillance equipment or services produced or provided by an entity that the Secretary of Defense, in consultation with the Director of the National Intelligence or the Director of the Federal Bureau of Investigation, reasonably believes to be an entity owned or controlled by, or otherwise connected to, the government of a covered foreign country.

(b) In implementing the prohibition under Public Law 115-232, section 889, subsection (f), paragraph (1), heads of executive agencies administering loan, grant, or subsidy programs shall prioritize available funding and technical support to assist affected businesses, institutions and organizations as is reasonably necessary for those affected entities to transition from covered communications equipment and services, to procure replacement equipment and services, and to ensure that communications service to users and customers is sustained.

(c) See Public Law 115-232, section 889 for additional information.

(d) See also §200.471.

s. Federal Financial Assistance Planning During a Funding Hiatus or Government Shutdown

This term sets forth initial guidance that will be implemented for Federal assistance awards in the event of a lapse in appropriations, or a government shutdown. The Grants Officer may issue further guidance prior to an anticipated shutdown.

1. Unless there is an actual rescission of funds for specific grant or cooperative agreement obligations, non-Federal entities under Federal financial assistance awards for which funds have been obligated generally will be able to continue to perform and incur allowable expenses under the award during a funding hiatus. Non-Federal entities are advised that ongoing activities by Federal employees involved in grant or cooperative agreement administration (including payment processing) or similar operational and administrative work cannot continue when there is a funding lapse. Therefore, there may be delays, including payment processing delays, in the event of a shutdown.

2. All award actions will be delayed during a government shutdown; if it appears that a non-Federal entity's performance under a grant or cooperative agreement will require agency involvement, direction, or clearance during the period of a possible government shutdown, the Program Officer or Grants Officer, as appropriate, may attempt to provide such involvement, direction, or clearance prior to the shutdown or advise non-Federal entities that such involvement, direction, or clearance will not be forthcoming during the shutdown. Accordingly, non-Federal entities whose ability to withdraw funds is subject to prior agency approval, which in general are non-Federal entities that have been designated high risk, non-Federal entities under construction awards, or are otherwise limited to reimbursements or subject to agency review, will be able to draw funds down from the relevant Automatic Standard Application for Payment (ASAP) account only if agency approval is given and coded into ASAP prior to any government shutdown or closure. This limitation may not be lifted during a government shutdown. Non-Federal entities should plan to work with the Grants Officer to request prior approvals in advance of a shutdown wherever possible. Non-Federal entities whose authority to draw down award funds is restricted may decide to suspend work until the government reopens.

3. The ASAP system should remain operational during a government shutdown. Non-Federal entities that do not require any Grants Officer or agency approval to draw down advance funds from their ASAP accounts should be able to do so during a shutdown. The 30-day limitation on the drawdown of advance funds will still apply notwithstanding a government shutdown (see section B.02.b.1 of these terms).

K:\2022\1043 JOB FOLDERS\CAD Resources\Titleblocks\North Route - East of U.S-23\North Route - East of U.S-23\Cover.dwg: 8/30/2023 1:34 PM:

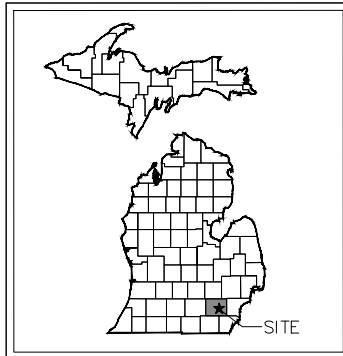

**EDA Project Number:
06-79-06299**



LEGEND

- R/W — EX. RIGHT OF WAY
- EX. EASEMENT LINE
- - - - - EX. Q. DITCH
- - - - - EX. GRAVEL
- EX. WETLAND LIMITS
- ==== EX. CURB/PAVEMENT
- + + + + + RR TRACK
- ○ ○ ○ ○ EX. FENCE(STEEL)
- □ □ □ □ EX. FENCE(WOOD)
- ○ ○ ○ ○ EX. GUARDRAIL
- ~ ~ ~ ~ ~ EX. TREELINE
- — — — — EX. WATER MAIN
- - - - - EX. STORM SEWER
- - - - - EX. SANITARY SEWER
- - - - - EX. UNDG GAS
- ~ ~ ~ ~ ~ EX. UNDG ELECTRIC
- - - - - EX. UNDG TELE
- - - - - JOINT TRENCH (POWER,TELE,CABLE)
- - - - - EX. UNDG CABLE
- - - - - EX. UNDG STEAM
- ~ ~ ~ ○ EX. OH ELECTRIC
- ○ ○ ○ ○ EX. WATER VALVE
- ○ ○ ○ ○ EX. HYDRANT
- ○ ○ ○ ○ EX. WATER MANHOLE
- □ □ □ □ EX. STORM INLET/CATCH BASIN
- ○ ○ ○ ○ EX. ROUND STORM CATCH BASIN
- ○ ○ ○ ○ EX. STORM MANHOLE
- ○ ○ ○ ○ EX. STORM END SECTION
- ○ ○ ○ ○ EX. SANITARY MANHOLE
- ○ ○ ○ ○ EX. STEAM MANHOLE
- ○ ○ ○ ○ EX. GAS VALVE
- ○ ○ ○ ○ EX. GAS METER
- ○ ○ ○ ○ EX. ELECTRIC MANHOLE
- ○ ○ ○ ○ EX. ELECTRIC TRANS
- ○ ○ ○ ○ EX. UTILITY POLE
- ○ ○ ○ ○ EX. LIGHT POLE
- ○ ○ ○ ○ EX. TRAFFIC SIGNAL POLE
- ○ ○ ○ ○ EX. GUY WIRE
- ○ ○ ○ ○ EX. TELE MANHOLE
- ○ ○ ○ ○ EX. TELE PED
- ○ ○ ○ ○ EX. UNIDENTIFIED MANHOLE
- ○ ○ ○ ○ EX. TREE
- ○ ○ ○ ○ EX. SIGN
- — — — — PROP DESIGN UNDG
- □ □ □ □ PROP HANDHOLE
- □ □ □ □ PROP SIDEWALK RESTORATION
- □ □ □ □ PROP UTILITY CROSSING
- ○ ○ ○ ○ PROP FIBER MARKER POST

PERMITTING AGENCIES

MUNICIPALITY: PITTSFIELD TOWNSHIP 6201 W. MICHIGAN AVE. ANN ARBOR, MI 48108 (734) 794-6320
MUNICIPALITY: YPSILANTI TOWNSHIP BUILDING DEPT 7200 S. HURON RIVER DR. YPSILANTI, MI 48197 (734) 485-3943
MUNICIPALITY: CITY OF YPSILANTI DEPT OF PUBLIC SERVICES 14 WEST FOREST AVE. YPSILANTI, MI 48128 (734) 483-1421
DRAIN: WASHTENAW COUNTY WATER RESOURCE COMMISSION 705 N ZEEB ROAD ANN ARBOR, MI 48103
DOT: MDOT BRIGHTON TSC 10321 E GRAND RIVER, SUITE 500 BRIGHTON, MI 48116 (810)227-4681

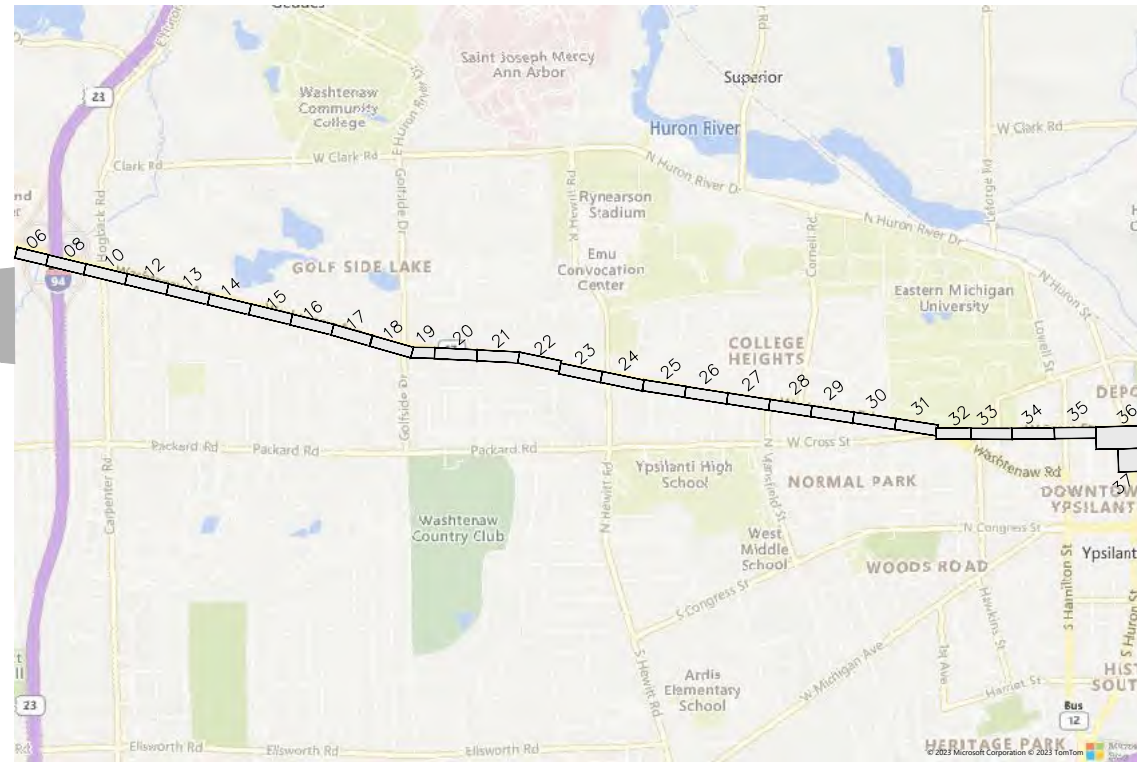
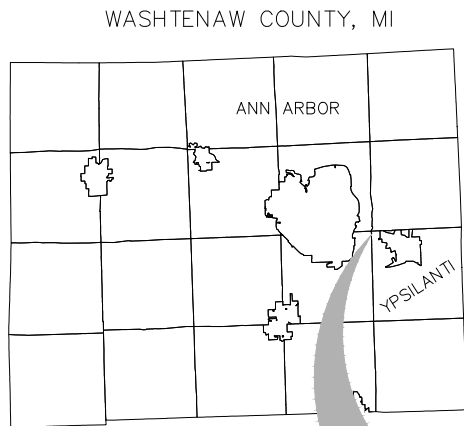

SHEET INDEX

SHEET #(s)	DESCRIPTION
01	LOCATOR MAP & INDEX
02	NOTES & CONTACTS
03	HANDHOLE & FIBER MARKER DETAIL
04	SPLICE & SLACK DETAILS
05	SIDEWALK RESTORATION DETAILS
06-37	PLAN SHEETS & CROSS SECTIONS
38-39	PEDESTRIAN DETOUR



August 30, 2023



THE LOCATIONS OF EXISTING UNDERGROUND UTILITIES ARE SHOWN IN AN APPROXIMATE WAY ONLY AND HAVE NOT BEEN INDEPENDENTLY VERIFIED. THE CONTRACTOR SHALL DETERMINE THE EXACT LOCATION OF ALL EXISTING UTILITIES BEFORE COMMENCING WORK, AND AGREES TO BE FULLY RESPONSIBLE FOR ANY AND ALL DAMAGES WHICH MIGHT BE OCCASIONED BY THE CONTRACTOR'S FAILURE TO EXACTLY LOCATE AND PRESERVE ANY AND ALL UNDERGROUND UTILITIES.

ANN ARBOR SPARK FIBER BACKBONE INFRASTRUCTURE
THIS PROJECT WILL PLACE INFRASTRUCTURE FOR THE PLACEMENT OF FIBER OPTIC CABLE TO CONNECT THE CITY OF ANN ARBOR WITH THE CITY OF YPSILANTI

REVISION		
REV #	DATE	DESCRIPTION
01	05/30/23	ADDED DRAIN DETAIL SHT 15. CORRECTED DRAIN NAME SHT 26
02	06/22/23	ADD WTR DIM PER PITTSFIELD, CORRECTED 6" WTR SHT 18
03	06/30/23	ADD WTR & SAN SRV SHTS 10,17&18. DEPTH NOTE SHT 18
04	08/30/23	REV PER CITY OF YPSI COMMENTS. ADD SHTS 38 & 39

METRO ENGINEERING SOLUTIONS
33900 SCHOOLCRAFT RD
LIVONIA, MICHIGAN 48150
PHONE: 734.483.1427 FAX: 734.483.3431
www.metroes.net

NORTH ROUTE - EAST OF U.S. 23	
MES JOB# 1043-22	DRAWN — KMM
PLOT SCALE = 1" = 50'	CHECKED - JB
PLAN DATE = 05/11/2023	

ANN ARBOR SPARK	
CORRIDOR FIBER OPTIC BACKBONE PROJECT	
ANN ARBOR	
WASHTENAW COUNTY, MI	

PERMITS REQUIRED:

<input type="checkbox"/> CITY OF ANN ARBOR	<input checked="" type="checkbox"/> CITY OF YPSILANTI	<input type="checkbox"/> EGLE
<input checked="" type="checkbox"/> WASHTENAW COUNTY	<input checked="" type="checkbox"/> YPSILANTI TOWNSHIP	<input type="checkbox"/> RR
<input checked="" type="checkbox"/> WASHTENAW COUNTY DRAIN	<input checked="" type="checkbox"/> PITTSFIELD TOWNSHIP	<input checked="" type="checkbox"/> MDOT

SHEET INFORMATION

TOTAL SHEETS	SHEET NO.
39	01

GENERAL REQUIREMENTS

- A. ALL WORK PERFORMED BY THE CONTRACTOR SHALL BE IN ACCORDANCE WITH THE CITY'S SPECIFICATIONS AND ALL APPLICABLE STANDARDS INCLUDED BUT NOT LIMITED TO THE FOLLOWING:
 - a. ANSI, ATIS, ASTM, BOCA, BICSI, EIA, IEEE, MI-OSHA, NEMA NESC, NFPA, OSHA, TIA, UL, AND ANY OTHER APPLICABLE INDUSTRY STANDARD(S).
- B. ALL TRAFFIC CONTROL NEEDED TO PERFORM ANY AND ALL PORTIONS OF THE WORK IS THE RESPONSIBILITY OF THE CONTRACTOR AND SHALL BE INCLUDED IN THE COST, REGARDLESS OF THE NUMBER OF TRAFFIC CONTROL MOBILIZATIONS AND SETUPS REQUIRED.
- C. ANY DAMAGE TO AND NOT LIMITED TO: LANDSCAPING, PRIVATE PROPERTY, UNIVERSITY OF MICHIGAN PROPERTY, ROADS, CURB AND GUTTER, SIDEWALK, OR EXISTING UTILITIES SHALL BE REPAIRED BY THE CONTRACTOR AND/OR ANY THEIR SUB-CONTRACTOR(S) IMMEDIATELY AT NO COST TO THE PROJECT.
- D. THE CONTRACTOR SHALL CONFINE WORK TO ROW PROPERTY AT ALL TIMES. AT NO TIME, SHALL THE CONTRACTOR ENTER PRIVATE PROPERTY, UNIVERSITY OF MICHIGAN PROPERTY, OR PERFORM ANY WORK NOT AUTHORIZED BY THE CITY OF ANN ARBOR.
- E. THE CONTRACTOR IS RESPONSIBLE FOR LOCATING ALL EXISTING UNDERGROUND SERVICES INCLUDING: ELECTRIC, GAS, TELEPHONE, DATA, WATER, AND SEWER PRIOR TO BEGINNING ANY UNDERGROUND WORK. COORDINATION AND COMPLIANCE WITH MISS DIG ARE REQUIRED.
- F. THE CONTRACTOR WILL PROVIDE EXPERIENCED INSTALLERS WHO ARE LICENSED OR CERTIFIED TO INSTALL CORNING FIBER MANUFACTURED MATERIAL.
- G. THE CONTRACTOR IS REQUIRED TO FACILITATE INSPECTIONS OF WORK WITH CITY OF ANN ARBOR AND THE CITY'S DESIGNATED REPRESENTATIVE (DESIGN, ENGINEERING SERVICES CONTRACTOR) THAT IS PROVIDING CONSTRUCTION OVERSITE UNDER A SEPARATE CONTRACT. ANY DEFICIENCIES REVEALED DURING INSPECTIONS BY CITY AND/OR DESIGNATED REPRESENTATIVES OF THE CITY OF ANN ARBOR, ARE THE SOLE RESPONSIBILITY OF THE CONTRACTOR TO RESOLVE.
- H. WHEN CONSTRUCTION IS COMPLETED, THE CONTRACTOR SHALL PERFORM CONTINUITY TESTING OF OPTICAL FIBERS USING OTDR AND INDUSTRY STANDARDS FOR TESTING. REFER TO SECTION "ACCEPTANCE AND TESTING" FOR REQUIREMENTS.
- I. THE CONTRACTOR SHALL INSTALL NECESSARY LIGHTING PROTECTION IN ACCORDANCE WITH AFOREMENTIONED STANDARDS.
- J. GROUNDING FOR UNDERGROUND NETWORK SEGMENTS IS REQUIRED AT EVERY SPLICE ENCLOSURE WITH A MINIMUM OF 8 (EIGHT) FEET OF GROUNDING ROD. GROUNDING RODS MUST MEET APPLICABLE INDUSTRY STANDARD SPECIFICATIONS.
- K. THE CONTRACTOR MUST ENSURE ADEQUATE CLEARANCE EXISTS BETWEEN PROPOSED FIBER BUILD AND OTHER UTILITIES, GROUND, RAIL, ROADS, AND WATER. AT A MINIMUM THE CONTRACTOR IS REQUIRED TO BUILD CONFORMING TO NESC CODES.
- L. THE CONTRACTOR IS ALSO RESPONSIBLE TO VERIFY LOCAL UTILITIES DO NOT HAVE MORE STRINGENT CLEARANCE CODES.
- M. THE CONTRACTOR IS RESPONSIBLE FOR ADHERING TO ALL RIGHT-OF-WAY AND UTILITY PERMITTING TERMS AND CONDITIONS AS SET FORTH IN EACH RIGHT-OF-WAY PERMIT.
- N. ANY CONSTRUCTION CHANGES MUST BE PRE-APPROVED BY THE CITY OF ANN ARBOR AND THE CITY OF ANN ARBOR'S DESIGN AND PLANNING CONTRACTOR BEFORE COMMENCING WITH SAID CHANGE. REDLINE EDITED DRAWINGS IN AUTOCAD FORMAT WILL BE REQUIRED TO DOCUMENT ANY APPROVED CHANGES.
- O. IF DEFICIENCIES AND/OR NON-COMPLIANCE ISSUES ARE DISCOVERED BY THE CITY OF ANN ARBOR PROJECT MANAGER OR THE CITY OR ANN ARBOR'S DESIGN AND PLANNING CONTRACTOR THE CONTRACTOR IS RESPONSIBLE FOR THE CORRECTION.
- P. THE CONTRACTOR IS RESPONSIBLE FOR ALL JOBSITE CLEANUP AND FOR REMOVAL OF ALL SPENT FIBER REELS AND OTHER MATERIALS USED DURING CONSTRUCTION.
- Q. CONSTRUCTION WILL BE SUBJECT TO PERIODIC INSPECTIONS BY CORNING AND THE CONSTRUCTION CONTRACTOR MUST COMPLY WITH ANY MODIFICATIONS MADE BY CORNING IN ORDER FOR THE CITY TO MAINTAIN ITS CORNING WARRANTY
- R. THE CONTRACTOR IS RESPONSIBLE FOR THE RESTORATION OF THE WORK AREA, INCLUDING LANDSCAPING, TO ITS ORIGINAL CONDITION AFTER WORK IS COMPLETE. SURROUNDING AREA MUST BE FILLED, LEVELED, AND COMPACTED. IF GRASS RESTORATION IS REQUIRED, CONTRACTOR MUST APPLY SEED OR HYDRO SEED. IF WORK CANNOT BE COMPLETED DUE TO UNSEASONAL CONDITIONS, THE WORK WILL BE COMPLETED WHEN FEASIBLE AND WITHIN THE 1-YEAR WARRANTY PERIOD. PAYMENT FOR PROJECTS WITH OUTSTANDING WORK DUE TO UNSEASONAL CONDITIONS WILL BE NEGOTIATED ON A PER PROJECT BASIS. AN ACTIVE PROJECT PUNCH LIST OF ITEMS WILL BE DOCUMENTED AND TRACKED BY THE CITY OF ANN ARBOR PROJECT MANAGER UNTIL ALL WORK HAS BEEN COMPLETED.
- S. IF POTHOLING IS REQUIRED IN SIDEWALK CONCRETE THE ENTIRE CONCRETE SLAB MUST BE RESTORED, NOT JUST THE POTHOLE AREA

M-DOT NOTES:

- A) DIRECTIONAL DRILLING SHALL BE CONSTRUCTED PER THE MDOT TRENCHLESS SPECIFICATION 3703A.
- B) NO PARKING OR STORAGE OF MATERIAL OR EQUIPMENT WILL BE ALLOWED WITHIN THE M-DOT RIGHT-OF-WAY.
- C) REMOVE AND REPLACE SIDEWALK AS DIRECTED BY THE FIELD INSPECTOR. UNLESS OTHERWISE SPECIFIED, ANY DAMAGED SIDEWALK SHALL BE REPLACED IN ACCORDANCE TO MDOT STANDARD DETAILS R-29 SERIES AND R-28 SERIES FOR SIDEWALK RAMPS.
- D) NO OPEN EXCAVATION SHALL REMAIN OVERNIGHT. ALL ACCESS PITS, OPEN EXCAVATION, EQUIPMENT AND SUPPLIES SHALL BE PROTECTED WITH SUITABLE FENCING AND PLASTIC DRUMS TO PROHIBIT PEDESTRIAN ACCESS TO THE WORK SITE. EQUIPMENT SHALL NOT BE USED AS FENCING TO PROTECT ACCESS PITS.
- E) A SAFE AND ADEQUATE TRAVEL ROUTE FOR PEDESTRIANS SHALL BE MAINTAINED AT ALL TIMES. PEDESTRIANS SHALL NOT BE DETOURED INTO THE ROADWAY OR DIRECTED TO CROSS THE TRUNKLINE AT NON SIGNALIZED INTERSECTIONS.
- F) ALL TRAFFIC CONTROL DEVICES INCLUDING SIGNS AND PAVEMENT MARKINGS (REMOVAL AND INSTALLATIONS) SHALL BE MAINTAINED AND/OR INSTALLED IN ACCORDANCE WITH CURRENT MDOT STANDARDS AND SPECIFICATIONS. CHARGES ARE THE SOLE RESPONSIBILITY OF THE PERMITTED.
- G) PERMITTEE AND CONTRACTORS ARE SUBJECT TO: PART 201, PUBLIC ACT 451 OF 1994, AS AMENDED. IN THE EVENT OF EXCAVATION ENCOUNTERING ENVIRONMENTAL CONTAMINATION OR AN UNDERGROUND TANK IN MDOT RIGHT-OF-WAY, WORK WITHIN THE RIGHT OF WAY SHALL CEASE UNTIL ALL ACTIONS/NOTIFICATIONS SPECIFIED BY PART 201 HAVE BEEN COMPLETED.
- H) PERMITTEE AND CONTRACTORS ARE SUBJECT TO PART 91, PUBLIC ACT 451 OF 1994, AS AMENDED. SOIL EROSION AND SEDIMENTATION CONTROL.
- I) ALL TRAFFIC CONTROL DEVICES USED ON THIS PERMIT SHALL MEET THE REQUIREMENTS OF THE "MICHIGAN MANUAL OF UNIFORM TRAFFIC CONTROL DEVICES," (MMUTCD) CURRENT EDITION, AND THE AMERICAN TRAFFIC SAFETY ASSOCIATION (ATSA) "QUALITY DEVICES ARE INCLUSIVE OF BUT NOT LIMITED TO SIGNS, BARRICADES, VERTICAL PANELS, DRUMS, WARNING LIGHTS, ARROW BOARDS, CHANGEABLE MESSAGE SIGNS, CONES, TUBULAR MARKERS, PAVEMENT TAPE, PAINT AND PAVEMENT MARKERS.
- J) ALL UTILITIES INCLUDING DRAINAGE FACILITIES SHALL BE LOCATED PRIOR TO EXCAVATION IN THE MDOT RIGHT-OF-WAY. MDOT FACILITIES ARE NOT LOCATED THROUGH THE MISS DIG SYSTEM. CONTACT THE MDOT PERMIT UNIT FOR INSTRUCTIONS.
- K) THE CONTRACTOR SHALL HAVE A MICHIGAN DEPARTMENT OF TRANSPORTATION APPROVED PLAN AND PERMIT ON-SITE AT ALL TIMES.
- L) THE CONTRACTOR SHALL SUBMIT MDOT ADVANCE NOTICE THROUGH CPS A MINIMUM OF FIVE (5) DAYS PRIOR TO START OF CONSTRUCTION.
- M) THE CONTRACTOR SHALL CONTACT THE INSPECTION AGENCY AS SHOWN ON THE PERMIT 72 HOURS PRIOR TO START OF CONSTRUCTION.
- N) THE CONTRACTOR SHALL CONTACT THE INSPECTION AGENCY AS SHOWN ON THE PERMIT AT THE COMPLETION OF CONSTRUCTION FOR A FINAL INSPECTION.
- O) THE APPLICANT/CONTRACTOR IS REQUIRED TO SUBMIT A COMPLETION NOTIFICATION VIA CPS UPON COMPLETING ALL WORK COVERED UNDER THIS PERMIT.
- P) THE MDOT RIGHT-OF-WAY SHALL BE RESTORED TO PRE-WORK CONDITIONS OR BETTER.
- Q) ALL DRILLING FLUIDS SHALL NOT ENTER THE STREETS, MANHOLES, SANITARY AND STORM SEWERS, AND OTHER DRAINAGE SYSTEMS, INCLUDING STREAMS AND RIVERS.

GENERAL CONSTRUCTION NOTES

- A. SODDED AREAS THAT MAY BE DISTURBED DURING INSTALLATION ARE TO BE RESTORED WITH 3" OF QUALITY TOP SOIL, SEED AND MULCH
- B. MAINTAIN A MINIMUM 18" CLEARANCE FROM ALL EXISTING PUBLIC UTILITIES
- C. PROPOSED INSTALLATION TO BE PLACED AT A MINIMUM DEPTH OF 48", UNLESS OTHERWISE NOTED ON PLANS
- D. SIDEWALK REMOVAL NECESSARY ON THIS PROJECT TO BE ACCOMPLISHED IN COMPLETE FLAGS AND REPLACED IN KIND PER JURISDICTIONAL SPECIFICATIONS
- E. HARD SURFACE REMOVAL OF STREETS AND/OR DRIVEWAYS TO BE SAW CUT FULL DEPTH AND REPLACED IN KIND PER JURISDICTIONAL SPECIFICATIONS
- F. CONTRACTOR TO FIELD VERIFY ALL EXISTING UTILITY LOCATIONS, INVERTS AND GRADES PRIOR TO STARTING CONSTRUCTION
- G. EXCAVATIONS BELOW HARD SURFACES TO BE BACKFILLED WITH MDOT CLASS II GRANULAR MATERIAL IN 8" LAYERS, WELL COMPACTED TO 98% OF ITS MAXIMUM UNIT WEIGHT AT A MOISTURE CONTENT LESS THAN SATURATION
- H. TEST HOLES TO BE CONSTRUCTED AS A 12" CYLINDRICAL HOLE. SOIL TO BE REMOVED USING A VACUUM TRUCK. HOLE TO BE BACKFILLED USING A GRANULAR MATERIAL TO THE BOTTOM OF THE EXISTING PAVEMENT. PAVEMENT TO BE REPLACED IN KIND PER MDOT SPECIFICATIONS

PROJECT CONTACTS:

CITY OF ANN ARBOR
TOM SHEWCHUK – ITSD DIRECTOR
734-794-6551
TSHEWCHUK@A2GOV.ORG

DTE ENERGY – COMMUNITY LIGHTING ANALYST
STEPHANIE SHARLOW
734-397-4091
STEPHANIE.SHARLOW@DTEENERGY.COM

YCUA – YPSILANTI COMMUNITY UTILITIES AUTHORITY
734-544-7316 OR 734-484-4600

ENGINEER ESTIMATE OF MATERIALS	
QTY	ITEM
20944	LINEAR FT OF 2-2" HDPE SDR-11 FOR FIBER
22	30"X48"X36" FIBERGLASS HAND HOLE
17289	LINEAR FT OF 432 STRAND FIBER CABLE
20944	LINEAR FT OF #6 TRACER WIRE
22	FIBER MARKER POST

REVISION		
REV #	DATE	DESCRIPTION
01	05/30/23	ADDED DRAIN DETAIL SHT 15. CORRECTED DRAIN NAME SHT 26
02	06/22/23	ADD WTR DIM PER PITTSFIELD, CORRECTED 6" WTR SHT 18
03	06/30/23	ADD WTR & SAN SRV SHTS 10,17&18. DEPTH NOTE SHT 18
04	08/30/23	REV PER CITY OF YPSI COMMENTS. ADD SHTS 38 & 39



THE LOCATIONS OF EXISTING UNDERGROUND UTILITIES ARE SHOWN IN AN APPROXIMATE WAY ONLY AND HAVE NOT BEEN INDEPENDENTLY VERIFIED. THE CONTRACTOR SHALL DETERMINE THE EXACT LOCATION OF ALL EXISTING UTILITIES BEFORE COMMENCING WORK, AND AGREES TO BE FULLY RESPONSIBLE FOR ANY AND ALL DAMAGES WHICH MIGHT BE OCCASIONED BY THE CONTRACTOR'S FAILURE TO EXACTLY LOCATE AND PRESERVE ANY AND ALL UNDERGROUND UTILITIES.

 33900 SCHOOLCRAFT RD LIVONIA, MICHIGAN 48150 PHONE: 734.483.1427 FAX: 734.483.3431 www.metroes.net	NORTH ROUTE – EAST OF U.S. 23		ANN ARBOR SPARK		PERMITS REQUIRED:			SHEET INFORMATION					
	MES JOB#	1043-22	DRAWN	— KMM	CORRIDOR FIBER OPTIC BACKBONE PROJECT ANN ARBOR WASHTENAW COUNTY, MI	<input type="checkbox"/> CITY OF ANN ARBOR	<input checked="" type="checkbox"/> CITY OF YPSILANTI	<input type="checkbox"/> EGLE	<table border="1"> <tr> <th>TOTAL SHEETS</th> <th>SHEET NO.</th> </tr> <tr> <td>39</td> <td>02</td> </tr> </table>	TOTAL SHEETS	SHEET NO.	39	02
	TOTAL SHEETS	SHEET NO.											
	39	02											
PLOT SCALE	= 1" = 50'	CHECKED	- JB	<input checked="" type="checkbox"/> WASHTENAW COUNTY	<input checked="" type="checkbox"/> YPSILANTI TOWNSHIP	<input type="checkbox"/> RR							
PLAN DATE	= 05/11/2023			<input checked="" type="checkbox"/> WASHTENAW COUNTY DRAIN	<input checked="" type="checkbox"/> PITTSFIELD TOWNSHIP	<input checked="" type="checkbox"/> MDOT							

30"X48"X36" QUAZITE HAND HOLE & FIBER MARKER POST

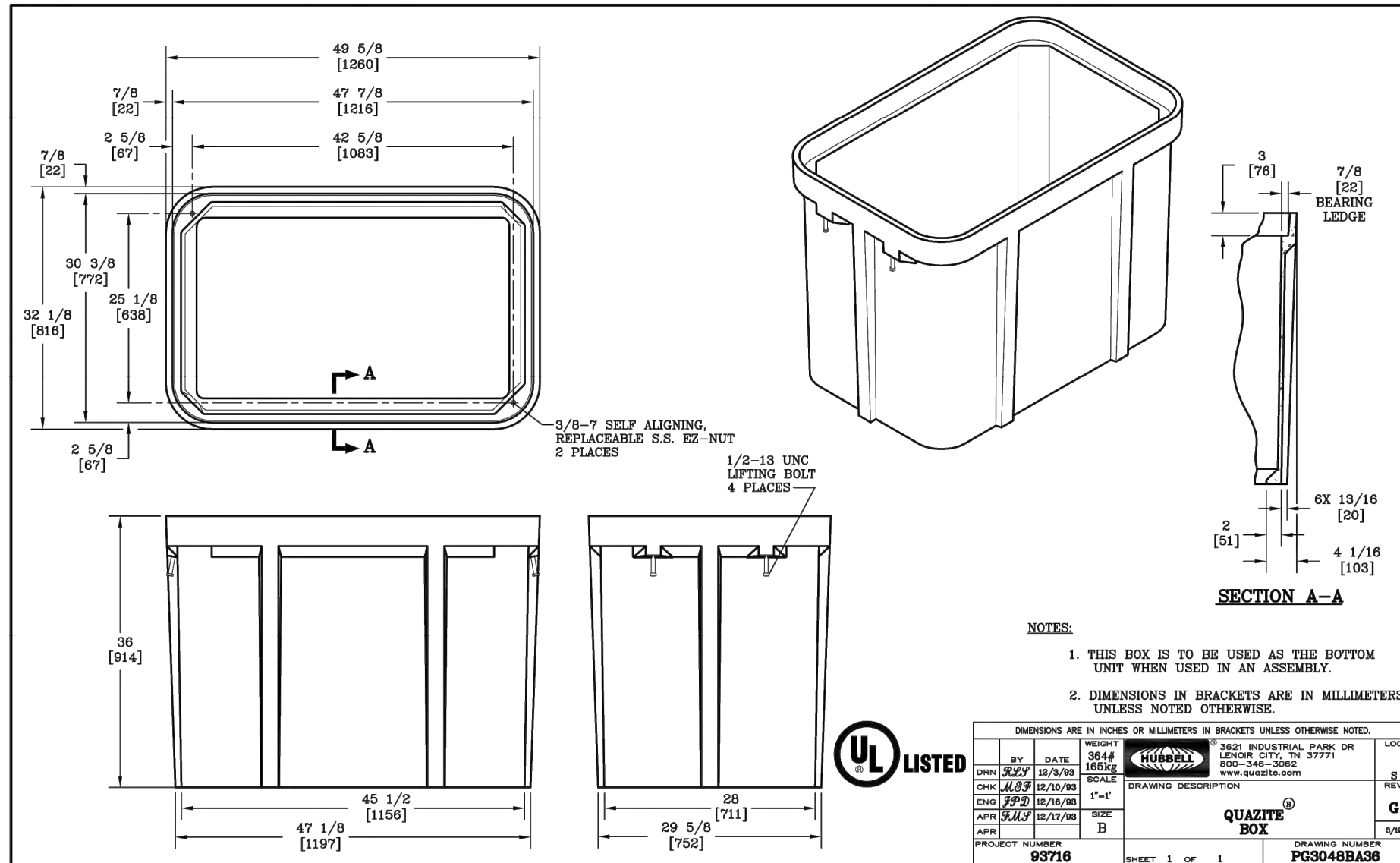

- NOTES:
1. THIS BOX IS TO BE USED AS THE BOTTOM UNIT WHEN USED IN AN ASSEMBLY.
 2. DIMENSIONS IN BRACKETS ARE IN MILLIMETERS UNLESS NOTED OTHERWISE.

DIMENSIONS ARE IN INCHES OR MILLIMETERS IN BRACKETS UNLESS OTHERWISE NOTED.

BY	DATE	WEIGHT	HUBBELL	3621 INDUSTRIAL PARK DR	LOC
DRN	RLP	12/3/93	364#	LENOIR CITY, TN 37771	S
CHK	MSF	12/10/93	165kg	800-346-3062	REV
ENG	FPD	12/16/93	SCALE	www.quazite.com	G
APR	MSF	12/17/93	1"=1'		3/12
APR			SIZE		
			B		
PROJECT NUMBER			DRAWING DESCRIPTION		
93716			QUAZITE® BOX		
SHEET 1 OF 1			DRAWING NUMBER		
			PG3048BA36		



THE LOCATIONS OF EXISTING UNDERGROUND UTILITIES ARE SHOWN IN AN APPROXIMATE WAY ONLY AND HAVE NOT BEEN INDEPENDENTLY VERIFIED. THE CONTRACTOR SHALL DETERMINE THE EXACT LOCATION OF ALL EXISTING UTILITIES BEFORE COMMENCING WORK, AND AGREES TO BE FULLY RESPONSIBLE FOR ANY AND ALL DAMAGES WHICH MIGHT BE OCCASIONED BY THE CONTRACTOR'S FAILURE TO EXACTLY LOCATE AND PRESERVE ANY AND ALL UNDERGROUND UTILITIES.

REVISION		
REV #	DATE	DESCRIPTION
01	05/30/23	ADDED DRAIN DETAIL SHT 15. CORRECTED DRAIN NAME SHT 26
02	06/22/23	ADD WTR DIM PER PITTSFIELD, CORRECTED 6" WTR SHT 18
03	06/30/23	ADD WTR & SAN SRV SHTS 10,17&18. DEPTH NOTE SHT 18
04	08/30/23	REV PER CITY OF YPSI COMMENTS. ADD SHTS 38 & 39

METRO ENGINEERING SOLUTIONS
 33900 SCHOOLCRAFT RD
 LIVONIA, MICHIGAN 48150
 PHONE: 734.483.1427 FAX: 734.483.3431
 www.metroes.net

NORTH ROUTE - EAST OF U.S. 23	
MES JOB# 1043-22	DRAWN - KMM
PLOT SCALE = 1" = 50'	CHECKED - JB
PLAN DATE = 05/11/2023	

ANN ARBOR SPARK
 CORRIDOR FIBER OPTIC BACKBONE PROJECT
 ANN ARBOR
 WASHTENAW COUNTY, MI

PERMITS REQUIRED:

<input type="checkbox"/> CITY OF ANN ARBOR	<input checked="" type="checkbox"/> CITY OF YPSILANTI	<input type="checkbox"/> EGLE
<input checked="" type="checkbox"/> WASHTENAW COUNTY	<input checked="" type="checkbox"/> YPSILANTI TOWNSHIP	<input type="checkbox"/> RR
<input checked="" type="checkbox"/> WASHTENAW COUNTY DRAIN	<input checked="" type="checkbox"/> PITTSFIELD TOWNSHIP	<input checked="" type="checkbox"/> MDOT

SHEET INFORMATION

TOTAL SHEETS	SHEET NO.
39	03

K:\2022\1043 JOB FOLDERS\CAD Resources\Titleblocks\North Route- East of US-23\North Route- East of 23_Cover.dwg: 8/30/2023 1:34 PM;

CONCEPTUAL SIDE VIEW

ROUTING TOP VIEW

NOTE:
LEAVE 75FT OF SLACK FROM CONDUIT TO CONDUIT.
LEAVE 60FT OF SLACK FOR END OF LINE NAP.
ROUTE MAIN AND DROP CABLES TOGETHER FROM CONDUITS TO CLOSURE.
DO NOT EXCEED MINIMUM CABLE BEND RADIUS. CONDUITS MUST NOT EXTEND MORE THAN 2" ABOVE GRAVEL.

DESCRIPTION	QTY	MANUFACTURER	PART #
DOMESTYLE CLOSURE	1		
BLACK TAPE	VARIES		

TYPICAL UNDERGROUND NAP LOCATION (UG-NAP)

DATE: 8/31/2017 REVISION: CLM SCALE: NTS

CONCEPTUAL SIDE VIEW

ROUTING TOP VIEW

NOTE:
FOR RE/NAP MAIN CABLE INPUT SIDE LEAVE 150FT OF SLACK AND 75FT FOR OUTPUT SIDE LATERAL 75FT FROM END OF CONDUIT.
FOR MCA/NAP LEAVE 200FT OF SLACK AND 75FT FOR LATERAL FROM CONDUIT TO CONDUIT.

DESCRIPTION	QTY	MANUFACTURER	PART #
DOMESTYLE CLOSURE	1		
BLACK TAPE	VARIES		

TYPICAL UNDERGROUND NAP/RE/MCA SPLICE CLOSURES (UG-NAP/RE/MCA)

DATE: 8/31/2017 REVISION: CLM SCALE: NTS

CONCEPTUAL SIDE VIEW

ROUTING TOP VIEW

NOTE:
FOR MCA/NAP LEAVE 130FT OF SLACK FROM CONDUIT TO CONDUIT IN MAIN CABLE. LEAVE 75FT FOR LATERAL CABLE. ROUTE MAIN, LATERAL AND DROP CABLES TOGETHER FROM CONDUITS TO CLOSURES. DO NOT EXCEED MINIMUM CABLE BEND RADIUS. CONDUITS MUST NOT EXTEND MORE THAN 2" ABOVE GRAVEL.

DESCRIPTION	QTY	MANUFACTURER	PART #
DOMESTYLE CLOSURE	1		
BLACK TAPE	VARIES		

TYPICAL UNDERGROUND MCA SPLICE LOCATION (UG-MCA)

DATE: 8/31/2017 REVISION: CLM SCALE: NTS

CONCEPTUAL SIDE VIEW

ROUTING TOP VIEW

NOTE:
DISTANCE FROM GROUND LEVEL TO TOP OF CONDUIT:
24" IN SUBDIVISIONS
36" ALONG STATE HIGHWAYS
48" UNDER STATE HIGHWAYS

DESCRIPTION	QTY	MANUFACTURER	PART #
HANDHOLE GRADE LEVEL ENCLOSURE, VARIOUS SIZES	1		
CONDUIT, HDPE SDR 13.5, VARIOUS SIZES	N/A		
#12 TRACER WIRE	N/A		

TYPICAL UNDERGROUND SLACK MEASUREMENT (UG-SM)

DATE: 8/31/2017 REVISION: CLM SCALE: NTS

CONCEPTUAL SIDE VIEW

NOTE:
CONDUIT SHOULD ENTER VAULTS AT MAXIMUM 20° ANGLE

DESCRIPTION	QTY	MANUFACTURER	PART #
HANDHOLE GRADE LEVEL ENCLOSURE, VARIOUS SIZES	1		
CONDUIT, HDPE SDR 13.5, VARIOUS SIZES	N/A		
#12 TRACER WIRE	N/A		
#57 STONE	VARIES		

TYPICAL VAULTS WITH GRAVEL UNDERNEATH (GRAVEL-UG)

DATE: 8/31/2017 REVISION: CLM SCALE: NTS

CAUTION
FIBER OPTIC CABLE

BB OF 45 CABLE ID: CABLE COUNT:

- CABLE ID TAGS ARE REQUIRED WHERE THERE ARE MULTIPLE CABLES WITHIN THE UG VAULTS
- SNAP TAGS ARE REQUIRED WHERE THERE ARE UG CABLES

REVISION		
REV #	DATE	DESCRIPTION
01	05/30/23	ADDED DRAIN DETAIL SHT 15. CORRECTED DRAIN NAME SHT 26
02	06/22/23	ADD WTR DIM PER PITTSFIELD, CORRECTED 6" WTR SHT 18
03	06/30/23	ADD WTR & SAN SRV SHTS 10,17&18. DEPTH NOTE SHT 18
04	08/30/23	REV PER CITY OF YPSI COMMENTS. ADD SHTS 38 & 39



THE LOCATIONS OF EXISTING UNDERGROUND UTILITIES ARE SHOWN IN AN APPROXIMATE WAY ONLY AND HAVE NOT BEEN INDEPENDENTLY VERIFIED. THE CONTRACTOR SHALL DETERMINE THE EXACT LOCATION OF ALL EXISTING UTILITIES BEFORE COMMENCING WORK, AND AGREES TO BE FULLY RESPONSIBLE FOR ANY AND ALL DAMAGES WHICH MIGHT BE OCCASIONED BY THE CONTRACTOR'S FAILURE TO EXACTLY LOCATE AND PRESERVE ANY AND ALL UNDERGROUND UTILITIES.

METRO ENGINEERING SOLUTIONS
33900 SCHOOLCRAFT RD
LIVONIA, MICHIGAN 48150
PHONE: 734.483.1427 FAX: 734.483.3431
www.metroes.net

NORTH ROUTE - EAST OF U.S. 23	
MES JOB#	1043-22
DRAWN	KMM
PLOT SCALE	1" = 50'
CHECKED	JB
PLAN DATE	05/11/2023

ANN ARBOR SPARK
CORRIDOR FIBER OPTIC BACKBONE PROJECT
ANN ARBOR
WASHTENAW COUNTY, MI

PERMITS REQUIRED:

<input type="checkbox"/> CITY OF ANN ARBOR	<input checked="" type="checkbox"/> CITY OF YPSILANTI	<input type="checkbox"/> EGLE
<input checked="" type="checkbox"/> WASHTENAW COUNTY	<input checked="" type="checkbox"/> YPSILANTI TOWNSHIP	<input type="checkbox"/> RR
<input checked="" type="checkbox"/> WASHTENAW COUNTY DRAIN	<input checked="" type="checkbox"/> PITTSFIELD TOWNSHIP	<input checked="" type="checkbox"/> MDOT

SHEET INFORMATION

TOTAL SHEETS	SHEET NO.
39	04

PITTSFIELD TOWNSHIP
SEC:02 T:03S R:06E

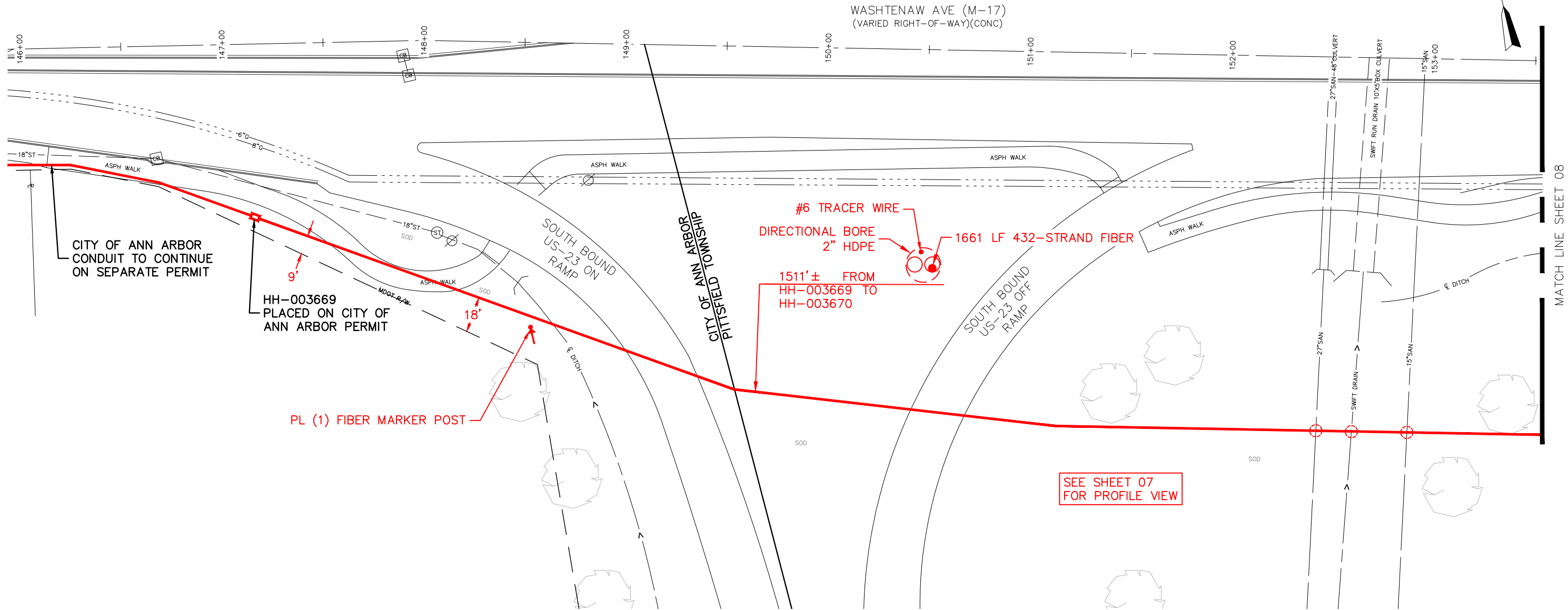
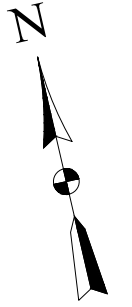

MATCH LINE SHEET 08

PL (1) FIBER MARKER POST

#6 TRACER WIRE
DIRECTIONAL BORE
2" HDPE
1661 LF 432-STRAND FIBER
1511'± FROM
HH-003669 TO
HH-003670

SEE SHEET 07
FOR PROFILE VIEW

K:\2022\1043 JOB FOLDERS\1043-22-0326\DWG\1043-22-0326_DS.dwg; 6/30/2023 10:32 AM;



THE LOCATIONS OF EXISTING UNDERGROUND UTILITIES ARE SHOWN IN AN APPROXIMATE WAY ONLY AND HAVE NOT BEEN INDEPENDENTLY VERIFIED. THE CONTRACTOR SHALL DETERMINE THE EXACT LOCATION OF ALL EXISTING UTILITIES BEFORE COMMENCING WORK, AND AGREES TO BE FULLY RESPONSIBLE FOR ANY AND ALL DAMAGES WHICH MIGHT BE OCCASIONED BY THE CONTRACTOR'S FAILURE TO EXACTLY LOCATE AND PRESERVE ANY AND ALL UNDERGROUND UTILITIES.

REVISION		
REV #	DATE	DESCRIPTION
01	05/30/23	ADDED DRAIN DETAIL SHT 15. CORRECTED DRAIN NAME SHT 26
02	06/22/23	ADD WTR DIM PER PITTSFIELD, CORRECTED 6" WTR SHT 18
03	06/30/23	ADD WTR & SAN SRV SHTS 10,17&18. DEPTH NOTE SHT 18
04	08/30/23	REV PER CITY OF YPSI COMMENTS. ADD SHTS 38 & 39

METRO ENGINEERING SOLUTIONS
33900 SCHOOLCRAFT RD
LIVONIA, MICHIGAN 48150
PHONE: 734.483.1427 FAX: 734.483.3431
www.metroes.net

NORTH ROUTE - EAST OF U.S. 23	
MES JOB# 1043-22	DRAWN - KMM
PLOT SCALE = 1" = 50'	CHECKED - JB
PLAN DATE = 05/11/2023	

ANN ARBOR SPARK
CORRIDOR FIBER OPTIC BACKBONE PROJECT
ANN ARBOR
WASHTENAW COUNTY, MI

PERMITS REQUIRED:		
<input type="checkbox"/> CITY OF ANN ARBOR	<input checked="" type="checkbox"/> CITY OF YPSILANTI	<input type="checkbox"/> EGLE
<input checked="" type="checkbox"/> WASHTENAW COUNTY	<input checked="" type="checkbox"/> YPSILANTI TOWNSHIP	<input type="checkbox"/> RR
<input checked="" type="checkbox"/> WASHTENAW COUNTY DRAIN	<input checked="" type="checkbox"/> PITTSFIELD TOWNSHIP	<input checked="" type="checkbox"/> MDOT

SHEET INFORMATION	
TOTAL SHEETS	SHEET NO.
39	06

K:\2022\1043 JOB FOLDERS\1043-22-0326\DWG\1043-22-0326_DS.dwg; 6/30/2023 10:32 AM;

SEE SHEET 06 FOR PLAN VIEW

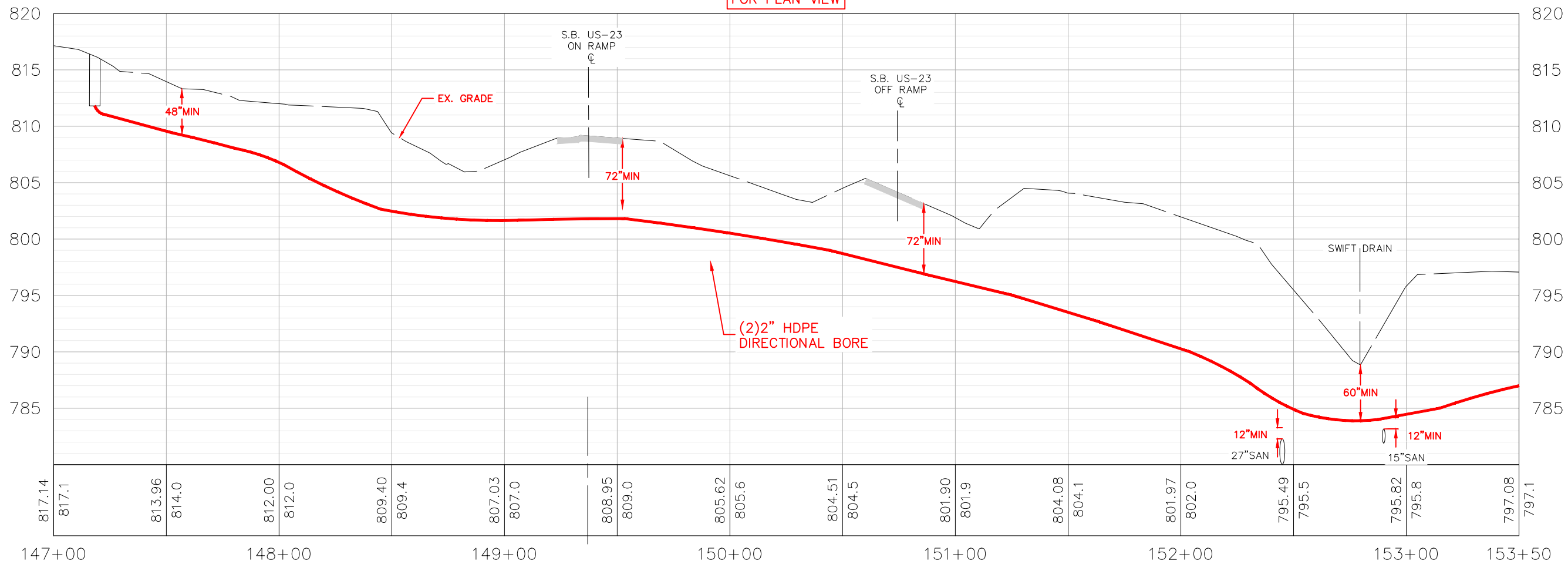

INSTALL
1"=50' HORIZONTAL
1"=10' VERTICAL



Know what's below.
Call before you dig.

THE LOCATIONS OF EXISTING UNDERGROUND UTILITIES ARE SHOWN IN AN APPROXIMATE WAY ONLY AND HAVE NOT BEEN INDEPENDENTLY VERIFIED. THE CONTRACTOR SHALL DETERMINE THE EXACT LOCATION OF ALL EXISTING UTILITIES BEFORE COMMENCING WORK, AND AGREES TO BE FULLY RESPONSIBLE FOR ANY AND ALL DAMAGES WHICH MIGHT BE OCCASIONED BY THE CONTRACTOR'S FAILURE TO EXACTLY LOCATE AND PRESERVE ANY AND ALL UNDERGROUND UTILITIES.

REVISION		
REV #	DATE	DESCRIPTION
01	05/30/23	ADDED DRAIN DETAIL SHT 15. CORRECTED DRAIN NAME SHT 26
02	06/22/23	ADD WTR DIM PER PITTSFIELD, CORRECTED 6" WTR SHT 18
03	06/30/23	ADD WTR & SAN SRV SHTS 10,17&18. DEPTH NOTE SHT 18
04	08/30/23	REV PER CITY OF YPSI COMMENTS. ADD SHTS 38 & 39

METRO ENGINEERING SOLUTIONS
 33900 SCHOOLCRAFT RD
 LIVONIA, MICHIGAN 48150
 PHONE: 734.483.1427 FAX: 734.483.3431
 www.metroes.net

NORTH ROUTE - EAST OF U.S. 23	
MES JOB# 1043-22	DRAWN - KMM
PLOT SCALE = 1" = 50'	CHECKED - JB
PLAN DATE = 05/11/2023	

ANN ARBOR SPARK
 CORRIDOR FIBER OPTIC BACKBONE PROJECT
 ANN ARBOR
 WASHTENAW COUNTY, MI

PERMITS REQUIRED:		
<input type="checkbox"/> CITY OF ANN ARBOR	<input checked="" type="checkbox"/> CITY OF YPSILANTI	<input type="checkbox"/> EGLE
<input checked="" type="checkbox"/> WASHTENAW COUNTY	<input checked="" type="checkbox"/> YPSILANTI TOWNSHIP	<input type="checkbox"/> RR
<input checked="" type="checkbox"/> WASHTENAW COUNTY DRAIN	<input checked="" type="checkbox"/> PITTSFIELD TOWNSHIP	<input checked="" type="checkbox"/> MDOT

SHEET INFORMATION	
TOTAL SHEETS	SHEET NO.
39	07

PITTSFIELD TOWNSHIP
SEC:02 T:03S R:06E

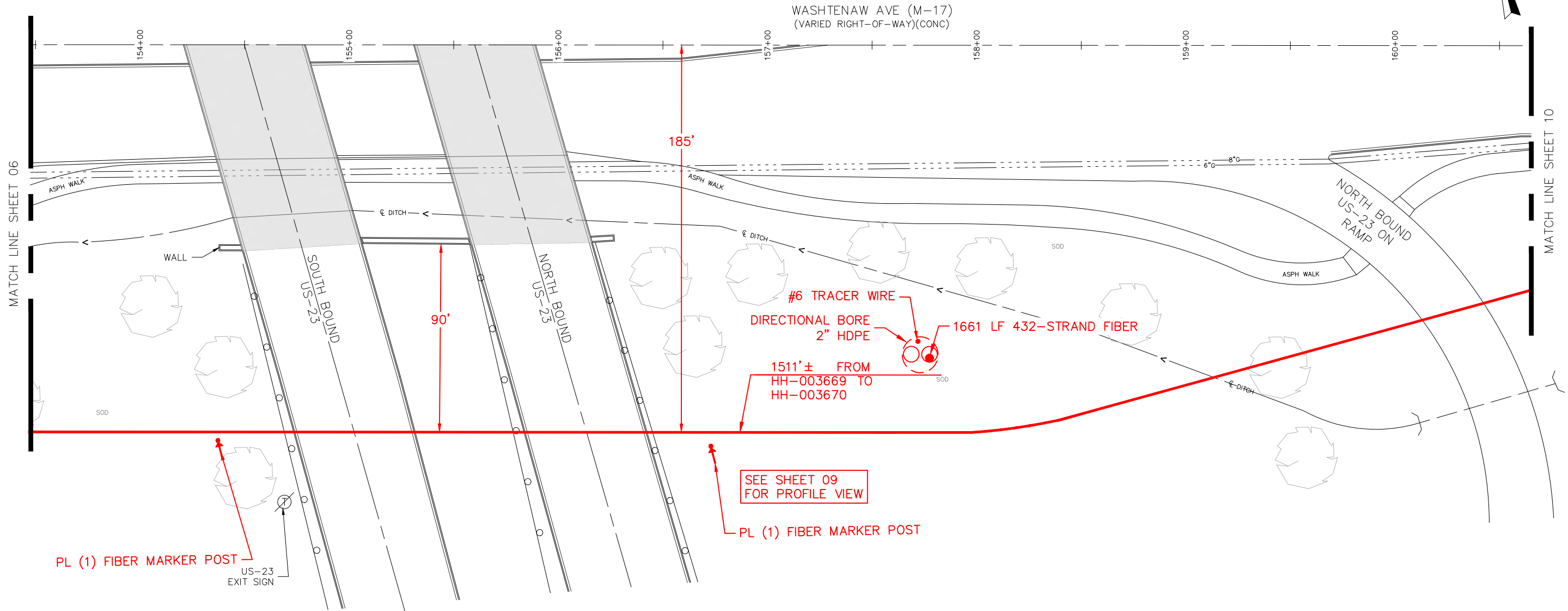
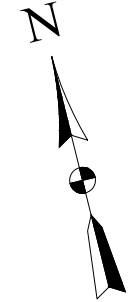

K:\2022\1043 JOB FOLDERS\1043-22-0326\DWG\1043-22-0326_DS.dwg; 6/30/2023 10:32 AM;



Call before you dig.

THE LOCATIONS OF EXISTING UNDERGROUND UTILITIES ARE SHOWN IN AN APPROXIMATE WAY ONLY AND HAVE NOT BEEN INDEPENDENTLY VERIFIED. THE CONTRACTOR SHALL DETERMINE THE EXACT LOCATION OF ALL EXISTING UTILITIES BEFORE COMMENCING WORK, AND AGREES TO BE FULLY RESPONSIBLE FOR ANY AND ALL DAMAGES WHICH MIGHT BE OCCASIONED BY THE CONTRACTOR'S FAILURE TO EXACTLY LOCATE AND PRESERVE ANY AND ALL UNDERGROUND UTILITIES.

METRO ENGINEERING SOLUTIONS
33900 SCHOOLCRAFT RD
LIVONIA, MICHIGAN 48150
PHONE: 734.483.1427 FAX: 734.483.3431
www.metroes.net

NORTH ROUTE - EAST OF U.S. 23	
MES JOB# 1043-22	DRAWN — KMM
PLOT SCALE = 1" = 50'	CHECKED - JB
PLAN DATE = 05/11/2023	

ANN ARBOR SPARK
CORRIDOR FIBER OPTIC BACKBONE PROJECT
ANN ARBOR
WASHTENAW COUNTY, MI

PERMITS REQUIRED:		
<input type="checkbox"/> CITY OF ANN ARBOR	<input checked="" type="checkbox"/> CITY OF YPSILANTI	<input type="checkbox"/> EGLE
<input checked="" type="checkbox"/> WASHTENAW COUNTY	<input checked="" type="checkbox"/> YPSILANTI TOWNSHIP	<input type="checkbox"/> RR
<input checked="" type="checkbox"/> WASHTENAW COUNTY DRAIN	<input checked="" type="checkbox"/> PITTSFIELD TOWNSHIP	<input checked="" type="checkbox"/> MDOT

SHEET INFORMATION	
TOTAL SHEETS	SHEET NO.
39	08

REVISION		
REV #	DATE	DESCRIPTION
01	05/30/23	ADDED DRAIN DETAIL SHT 15. CORRECTED DRAIN NAME SHT 26
02	06/22/23	ADD WTR DIM PER PITTSFIELD, CORRECTED 6" WTR SHT 18
03	06/30/23	ADD WTR & SAN SRV SHTS 10,17&18. DEPTH NOTE SHT 18
04	08/30/23	REV PER CITY OF YPSI COMMENTS. ADD SHTS 38 & 39

K:\2022\1043 JOB FOLDERS\1043-22-0326\DWG\1043-22-0326_DS.dwg; 6/30/2023 10:32 AM;

SEE SHEET 08 FOR PLAN VIEW

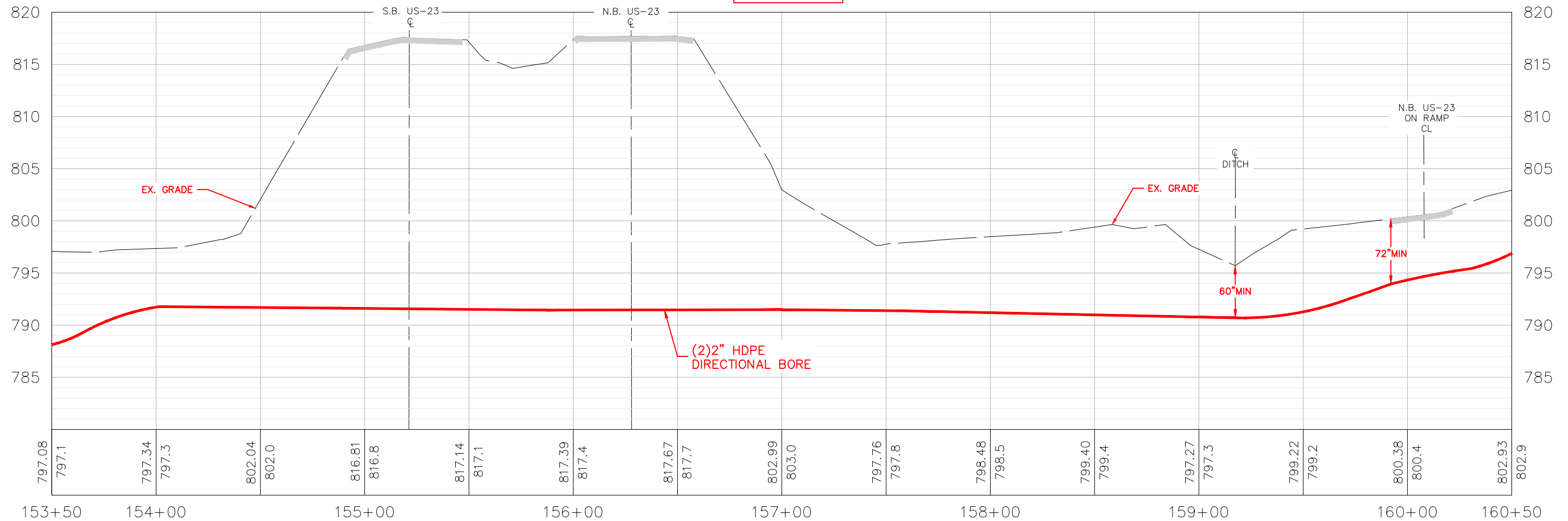

INSTALL
1"=50' HORIZONTAL
1"=10' VERTICAL



Know what's below.
Call before you dig.

THE LOCATIONS OF EXISTING UNDERGROUND UTILITIES ARE SHOWN IN AN APPROXIMATE WAY ONLY AND HAVE NOT BEEN INDEPENDENTLY VERIFIED. THE CONTRACTOR SHALL DETERMINE THE EXACT LOCATION OF ALL EXISTING UTILITIES BEFORE COMMENCING WORK, AND AGREES TO BE FULLY RESPONSIBLE FOR ANY AND ALL DAMAGES WHICH MIGHT BE OCCASIONED BY THE CONTRACTOR'S FAILURE TO EXACTLY LOCATE AND PRESERVE ANY AND ALL UNDERGROUND UTILITIES.

REVISION		
REV #	DATE	DESCRIPTION
01	05/30/23	ADDED DRAIN DETAIL SHT 15. CORRECTED DRAIN NAME SHT 26
02	06/22/23	ADD WTR DIM PER PITTSFIELD, CORRECTED 6" WTR SHT 18
03	06/30/23	ADD WTR & SAN SRV SHTS 10,17&18. DEPTH NOTE SHT 18
04	08/30/23	REV PER CITY OF YPSI COMMENTS. ADD SHTS 38 & 39

METRO ENGINEERING SOLUTIONS
 33900 SCHOOLCRAFT RD
 LIVONIA, MICHIGAN 48150
 PHONE: 734.483.1427 FAX: 734.483.3431
 www.metroes.net

NORTH ROUTE - EAST OF U.S. 23	
MES JOB# 1043-22	DRAWN — KMM
PLOT SCALE = 1" = 50'	CHECKED - JB
PLAN DATE = 05/11/2023	

ANN ARBOR SPARK
 CORRIDOR FIBER OPTIC BACKBONE PROJECT
 ANN ARBOR
 WASHTENAW COUNTY, MI

PERMITS REQUIRED:		
<input type="checkbox"/> CITY OF ANN ARBOR	<input checked="" type="checkbox"/> CITY OF YPSILANTI	<input type="checkbox"/> EGLE
<input checked="" type="checkbox"/> WASHTENAW COUNTY	<input checked="" type="checkbox"/> YPSILANTI TOWNSHIP	<input type="checkbox"/> RR
<input checked="" type="checkbox"/> WASHTENAW COUNTY DRAIN	<input checked="" type="checkbox"/> PITTSFIELD TOWNSHIP	<input checked="" type="checkbox"/> MDOT

SHEET INFORMATION	
TOTAL SHEETS	SHEET NO.
39	09

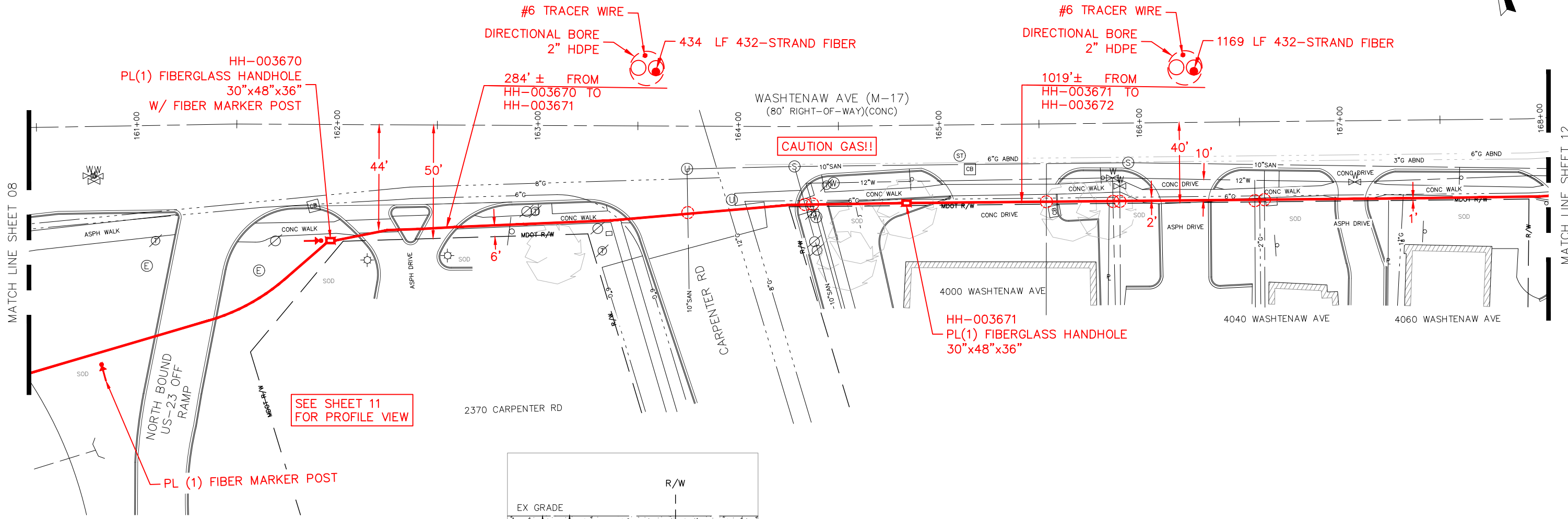
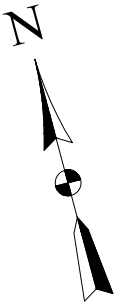

SEE SHEET 11 FOR PROFILE VIEW

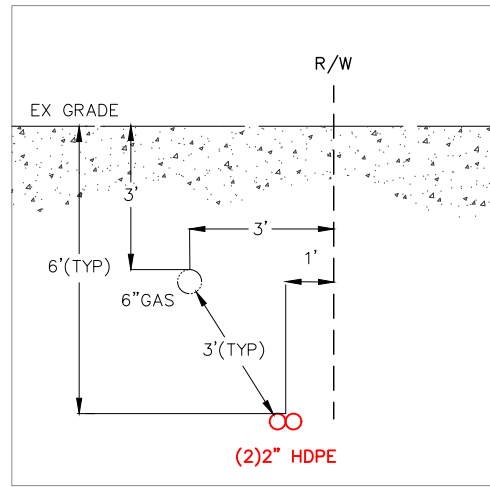

- BORE SECTION NOTES:**
1. CONTRACTOR TO VERIFY DEPTH OF 6" STEEL GAS MAIN
 2. ADJUST DEPTH AT UTILITY CROSSINGS AS REQUIRED

REVISION		
REV #	DATE	DESCRIPTION
01	05/30/23	ADDED DRAIN DETAIL SHT 15. CORRECTED DRAIN NAME SHT 26
02	06/22/23	ADD WTR DIM PER PITTSFIELD, CORRECTED 6" WTR SHT 18
03	06/30/23	ADD WTR & SAN SRV SHTS 10,17&18. DEPTH NOTE SHT 18
04	08/30/23	REV PER CITY OF YPSI COMMENTS. ADD SHTS 38 & 39



THE LOCATIONS OF EXISTING UNDERGROUND UTILITIES ARE SHOWN IN AN APPROXIMATE WAY ONLY AND HAVE NOT BEEN INDEPENDENTLY VERIFIED. THE CONTRACTOR SHALL DETERMINE THE EXACT LOCATION OF ALL EXISTING UTILITIES BEFORE COMMENCING WORK, AND AGREES TO BE FULLY RESPONSIBLE FOR ANY AND ALL DAMAGES WHICH MIGHT BE OCCASIONED BY THE CONTRACTOR'S FAILURE TO EXACTLY LOCATE AND PRESERVE ANY AND ALL UNDERGROUND UTILITIES.

METRO ENGINEERING SOLUTIONS

33900 SCHOOLCRAFT RD
LIVONIA, MICHIGAN 48150
PHONE: 734.483.1427 FAX: 734.483.3431
www.metroes.net

NORTH ROUTE - EAST OF U.S. 23	
MES JOB# 1043-22	DRAWN - KMM
PLOT SCALE = 1" = 50'	CHECKED - JB
PLAN DATE = 05/11/2023	

ANN ARBOR SPARK
CORRIDOR FIBER OPTIC BACKBONE PROJECT
ANN ARBOR
WASHTENAW COUNTY, MI

PERMITS REQUIRED:		
<input type="checkbox"/> CITY OF ANN ARBOR	<input checked="" type="checkbox"/> CITY OF YPSILANTI	<input type="checkbox"/> EGLE
<input checked="" type="checkbox"/> WASHTENAW COUNTY	<input checked="" type="checkbox"/> YPSILANTI TOWNSHIP	<input type="checkbox"/> RR
<input checked="" type="checkbox"/> WASHTENAW COUNTY DRAIN	<input checked="" type="checkbox"/> PITTSFIELD TOWNSHIP	<input checked="" type="checkbox"/> MDOT

SHEET INFORMATION	
TOTAL SHEETS	SHEET NO.
39	10

K:\2022\1043 JOB FOLDERS\1043-22-0326\DWG\1043-22-0326_DS.dwg; 6/30/2023 10:32 AM;



Know what's below.
Call before you dig.

THE LOCATIONS OF EXISTING UNDERGROUND UTILITIES ARE SHOWN IN AN APPROXIMATE WAY ONLY AND HAVE NOT BEEN INDEPENDENTLY VERIFIED. THE CONTRACTOR SHALL DETERMINE THE EXACT LOCATION OF ALL EXISTING UTILITIES BEFORE COMMENCING WORK, AND AGREES TO BE FULLY RESPONSIBLE FOR ANY AND ALL DAMAGES WHICH MIGHT BE OCCASIONED BY THE CONTRACTOR'S FAILURE TO EXACTLY LOCATE AND PRESERVE ANY AND ALL UNDERGROUND UTILITIES.

METRO ENGINEERING SOLUTIONS
 33900 SCHOOLCRAFT RD
 LIVONIA, MICHIGAN 48150
 PHONE: 734.483.1427 FAX: 734.483.3431
 www.metroes.net

NORTH ROUTE – EAST OF U.S. 23	
MES JOB# 1043-22	DRAWN — KMM
PLOT SCALE = 1" = 50'	CHECKED - JB
PLAN DATE = 05/11/2023	

ANN ARBOR SPARK
 CORRIDOR FIBER OPTIC BACKBONE PROJECT
 ANN ARBOR
 WASHTENAW COUNTY, MI

PERMITS REQUIRED:

<input type="checkbox"/> CITY OF ANN ARBOR	<input checked="" type="checkbox"/> CITY OF YPSILANTI	<input type="checkbox"/> EGLE
<input checked="" type="checkbox"/> WASHTENAW COUNTY	<input checked="" type="checkbox"/> YPSILANTI TOWNSHIP	<input type="checkbox"/> RR
<input checked="" type="checkbox"/> WASHTENAW COUNTY DRAIN	<input checked="" type="checkbox"/> PITTSFIELD TOWNSHIP	<input checked="" type="checkbox"/> MDOT

SHEET INFORMATION

TOTAL SHEETS	SHEET NO.
39	11

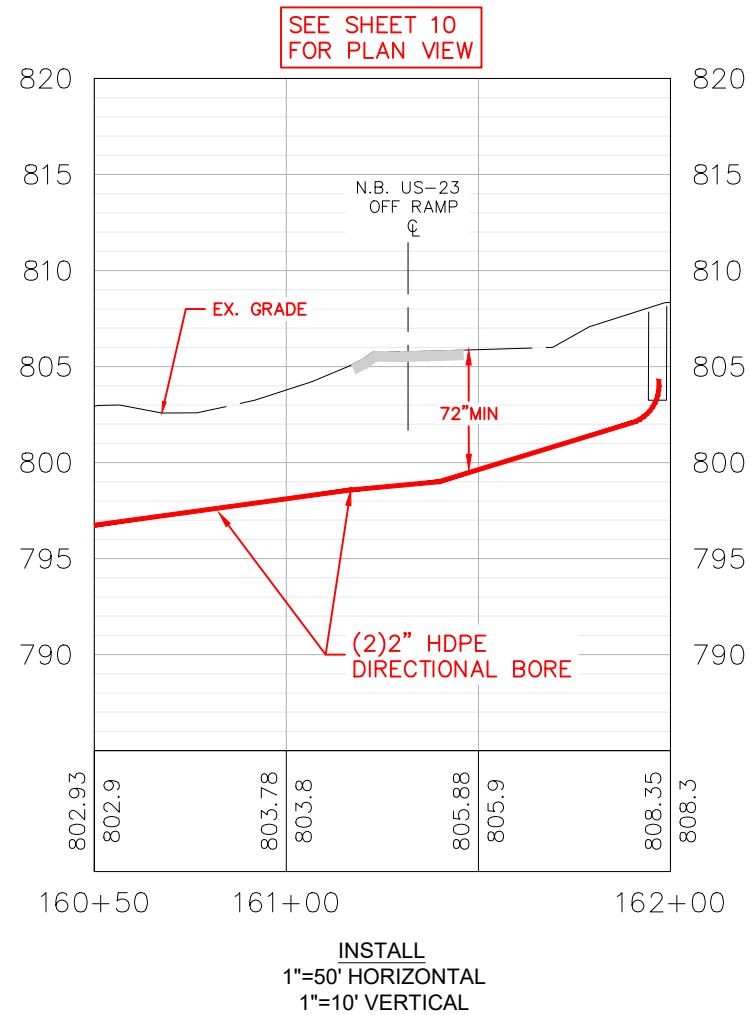

REVISION		
REV #	DATE	DESCRIPTION
01	05/30/23	ADDED DRAIN DETAIL SHT 15. CORRECTED DRAIN NAME SHT 26
02	06/22/23	ADD WTR DIM PER PITTSFIELD, CORRECTED 6" WTR SHT 18
03	06/30/23	ADD WTR & SAN SRV SHTS 10,17&18. DEPTH NOTE SHT 18
04	08/30/23	REV PER CITY OF YPSI COMMENTS. ADD SHTS 38 & 39

PITTSFIELD TOWNSHIP
SEC:01 T:03S R:06E

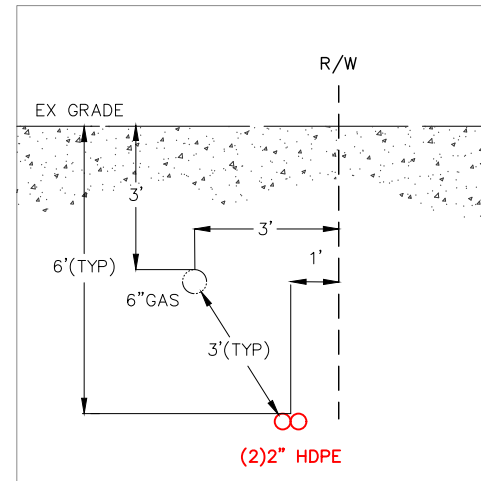
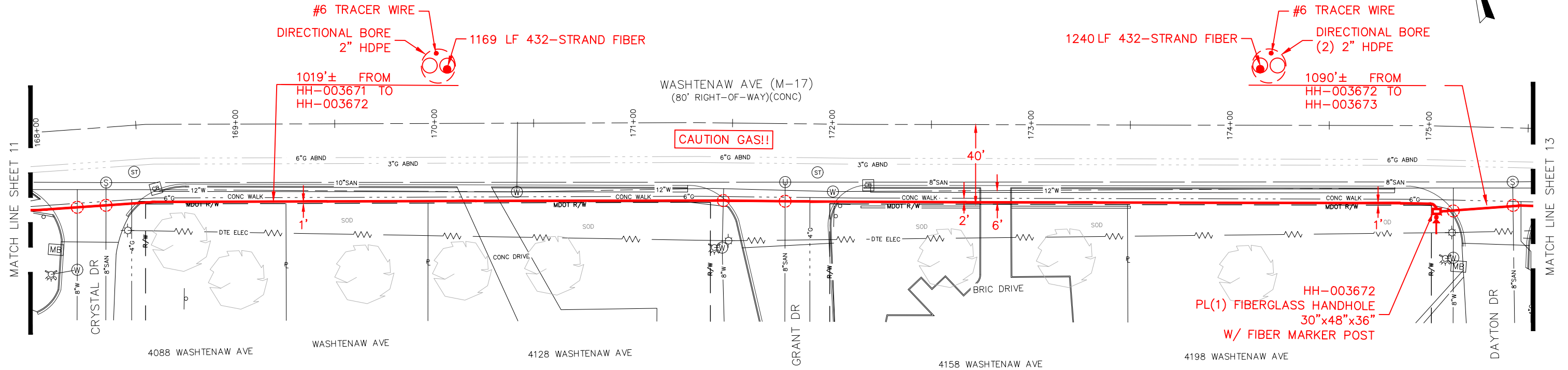
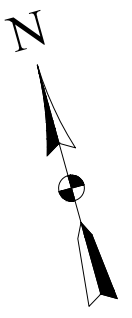

- BORE SECTION NOTES:**
1. CONTRACTOR TO VERIFY DEPTH OF 6" STEEL GAS MAIN
 2. ADJUST DEPTH AT UTILITY CROSSINGS AS REQUIRED

TYPICAL BORE SECTION
LOOKING EAST
STA 164+00 - STA 204+50
NOT TO SCALE

REVISION		
REV #	DATE	DESCRIPTION
01	05/30/23	ADDED DRAIN DETAIL SHT 15. CORRECTED DRAIN NAME SHT 26
02	06/22/23	ADD WTR DIM PER PITTSFIELD, CORRECTED 6" WTR SHT 18
03	06/30/23	ADD WTR & SAN SRV SHTS 10,17&18. DEPTH NOTE SHT 18
04	08/30/23	REV PER CITY OF YPSI COMMENTS. ADD SHTS 38 & 39



THE LOCATIONS OF EXISTING UNDERGROUND UTILITIES ARE SHOWN IN AN APPROXIMATE WAY ONLY AND HAVE NOT BEEN INDEPENDENTLY VERIFIED. THE CONTRACTOR SHALL DETERMINE THE EXACT LOCATION OF ALL EXISTING UTILITIES BEFORE COMMENCING WORK, AND AGREES TO BE FULLY RESPONSIBLE FOR ANY AND ALL DAMAGES WHICH MIGHT BE OCCASIONED BY THE CONTRACTOR'S FAILURE TO EXACTLY LOCATE AND PRESERVE ANY AND ALL UNDERGROUND UTILITIES.

METRO ENGINEERING SOLUTIONS
33900 SCHOOLCRAFT RD
LIVONIA, MICHIGAN 48150
PHONE: 734.483.1427 FAX: 734.483.3431
www.metroes.net

NORTH ROUTE - EAST OF U.S. 23	
MES JOB# 1043-22	DRAWN - KMM
PLOT SCALE = 1" = 50'	CHECKED - JB
PLAN DATE = 05/11/2023	

ANN ARBOR SPARK
CORRIDOR FIBER OPTIC BACKBONE PROJECT
ANN ARBOR
WASHTENAW COUNTY, MI

PERMITS REQUIRED:

<input type="checkbox"/> CITY OF ANN ARBOR	<input checked="" type="checkbox"/> CITY OF YPSILANTI	<input type="checkbox"/> EGLE
<input checked="" type="checkbox"/> WASHTENAW COUNTY	<input checked="" type="checkbox"/> YPSILANTI TOWNSHIP	<input type="checkbox"/> RR
<input checked="" type="checkbox"/> WASHTENAW COUNTY DRAIN	<input checked="" type="checkbox"/> PITTSFIELD TOWNSHIP	<input checked="" type="checkbox"/> MDOT

SHEET INFORMATION

TOTAL SHEETS	SHEET NO.
39	12

K:\2022\1043 JOB FOLDERS\1043-22-0326\DWG\1043-22-0326_DS.dwg; 6/30/2023 10:32 AM;

PITTSFIELD TOWNSHIP
SEC:01 T:03S R:06E

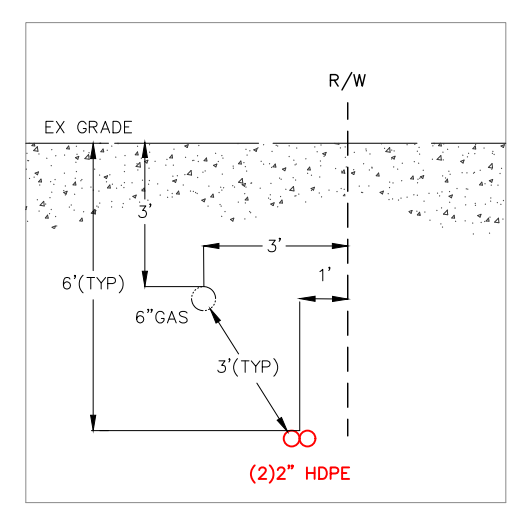
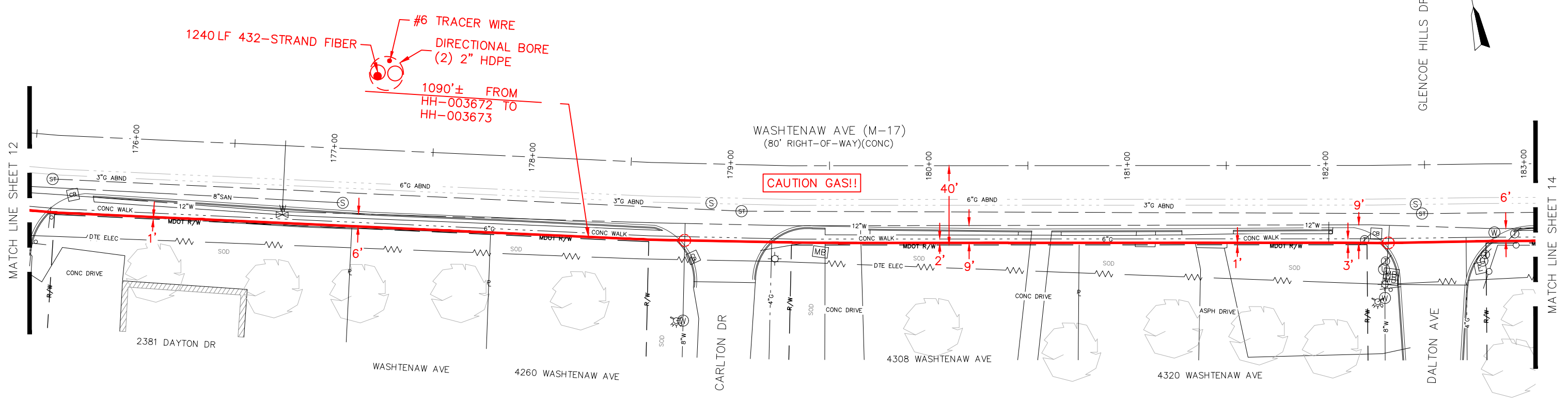
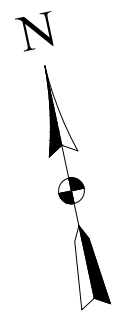

- BORE SECTION NOTES:**
1. CONTRACTOR TO VERIFY DEPTH OF 6" STEEL GAS MAIN
 2. ADJUST DEPTH AT UTILITY CROSSINGS AS REQUIRED

TYPICAL BORE SECTION
LOOKING EAST
STA 164+00 - STA 204+50
NOT TO SCALE

REVISION		
REV #	DATE	DESCRIPTION
01	05/30/23	ADDED DRAIN DETAIL SHT 15. CORRECTED DRAIN NAME SHT 26
02	06/22/23	ADD WTR DIM PER PITTSFIELD, CORRECTED 6" WTR SHT 18
03	06/30/23	ADD WTR & SAN SRV SHTS 10,17&18. DEPTH NOTE SHT 18
04	08/30/23	REV PER CITY OF YPSI COMMENTS. ADD SHTS 38 & 39



THE LOCATIONS OF EXISTING UNDERGROUND UTILITIES ARE SHOWN IN AN APPROXIMATE WAY ONLY AND HAVE NOT BEEN INDEPENDENTLY VERIFIED. THE CONTRACTOR SHALL DETERMINE THE EXACT LOCATION OF ALL EXISTING UTILITIES BEFORE COMMENCING WORK, AND AGREES TO BE FULLY RESPONSIBLE FOR ANY AND ALL DAMAGES WHICH MIGHT BE OCCASIONED BY THE CONTRACTOR'S FAILURE TO EXACTLY LOCATE AND PRESERVE ANY AND ALL UNDERGROUND UTILITIES.

METRO ENGINEERING SOLUTIONS
33900 SCHOOLCRAFT RD
LIVONIA, MICHIGAN 48150
PHONE: 734.483.1427 FAX: 734.483.3431
www.metroes.net

NORTH ROUTE - EAST OF U.S. 23	
MES JOB# 1043-22	DRAWN - KMM
PLOT SCALE = 1" = 50'	CHECKED - JB
PLAN DATE = 05/11/2023	

ANN ARBOR SPARK
CORRIDOR FIBER OPTIC BACKBONE PROJECT
ANN ARBOR
WASHTENAW COUNTY, MI

PERMITS REQUIRED:

<input type="checkbox"/> CITY OF ANN ARBOR	<input checked="" type="checkbox"/> CITY OF YPSILANTI	<input type="checkbox"/> EGLE
<input checked="" type="checkbox"/> WASHTENAW COUNTY	<input checked="" type="checkbox"/> YPSILANTI TOWNSHIP	<input type="checkbox"/> RR
<input checked="" type="checkbox"/> WASHTENAW COUNTY DRAIN	<input checked="" type="checkbox"/> PITTSFIELD TOWNSHIP	<input checked="" type="checkbox"/> MDOT

SHEET INFORMATION

TOTAL SHEETS	SHEET NO.
39	13

K:\2022\1043 JOB FOLDERS\1043-22-0326\DWG\1043-22-0326_DS.dwg; 6/30/2023 10:32 AM;

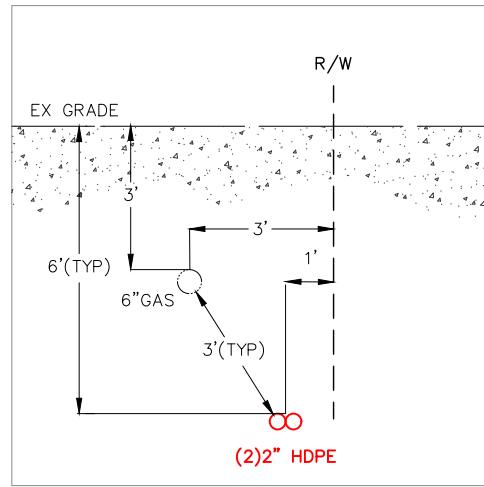
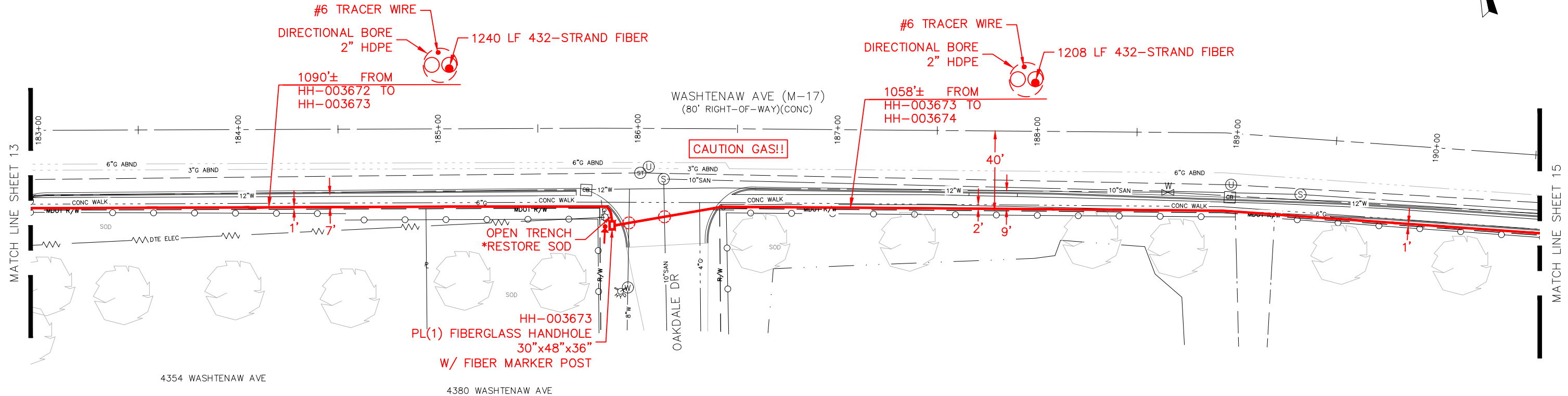
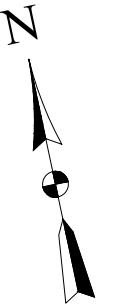

- BORE SECTION NOTES:**
1. CONTRACTOR TO VERIFY DEPTH OF 6" STEEL GAS MAIN
 2. ADJUST DEPTH AT UTILITY CROSSINGS AS REQUIRED

TYPICAL BORE SECTION
LOOKING EAST
STA 164+00 - STA 204+50
NOT TO SCALE

REVISION		
REV #	DATE	DESCRIPTION
01	05/30/23	ADDED DRAIN DETAIL SHT 15. CORRECTED DRAIN NAME SHT 26
02	06/22/23	ADD WTR DIM PER PITTSFIELD, CORRECTED 6" WTR SHT 18
03	06/30/23	ADD WTR & SAN SRV SHTS 10,17&18. DEPTH NOTE SHT 18
04	08/30/23	REV PER CITY OF YPSI COMMENTS. ADD SHTS 38 & 39



THE LOCATIONS OF EXISTING UNDERGROUND UTILITIES ARE SHOWN IN AN APPROXIMATE WAY ONLY AND HAVE NOT BEEN INDEPENDENTLY VERIFIED. THE CONTRACTOR SHALL DETERMINE THE EXACT LOCATION OF ALL EXISTING UTILITIES BEFORE COMMENCING WORK, AND AGREES TO BE FULLY RESPONSIBLE FOR ANY AND ALL DAMAGES WHICH MIGHT BE OCCASIONED BY THE CONTRACTOR'S FAILURE TO EXACTLY LOCATE AND PRESERVE ANY AND ALL UNDERGROUND UTILITIES.

METRO ENGINEERING SOLUTIONS
33900 SCHOOLCRAFT RD
LIVONIA, MICHIGAN 48150
PHONE: 734.483.1427 FAX: 734.483.3431
www.metroes.net

NORTH ROUTE - EAST OF U.S. 23	
MES JOB# 1043-22	DRAWN - KMM
PLOT SCALE = 1" = 50'	CHECKED - JB
PLAN DATE = 05/11/2023	

ANN ARBOR SPARK
CORRIDOR FIBER OPTIC BACKBONE PROJECT
ANN ARBOR
WASHTENAW COUNTY, MI

PERMITS REQUIRED:

<input type="checkbox"/> CITY OF ANN ARBOR	<input checked="" type="checkbox"/> CITY OF YPSILANTI	<input type="checkbox"/> EGLE
<input checked="" type="checkbox"/> WASHTENAW COUNTY	<input checked="" type="checkbox"/> YPSILANTI TOWNSHIP	<input type="checkbox"/> RR
<input checked="" type="checkbox"/> WASHTENAW COUNTY DRAIN	<input checked="" type="checkbox"/> PITTSFIELD TOWNSHIP	<input checked="" type="checkbox"/> MDOT

SHEET INFORMATION

TOTAL SHEETS	SHEET NO.
39	14

PITTSFIELD TOWNSHIP
SEC:01 T:03S R:06E

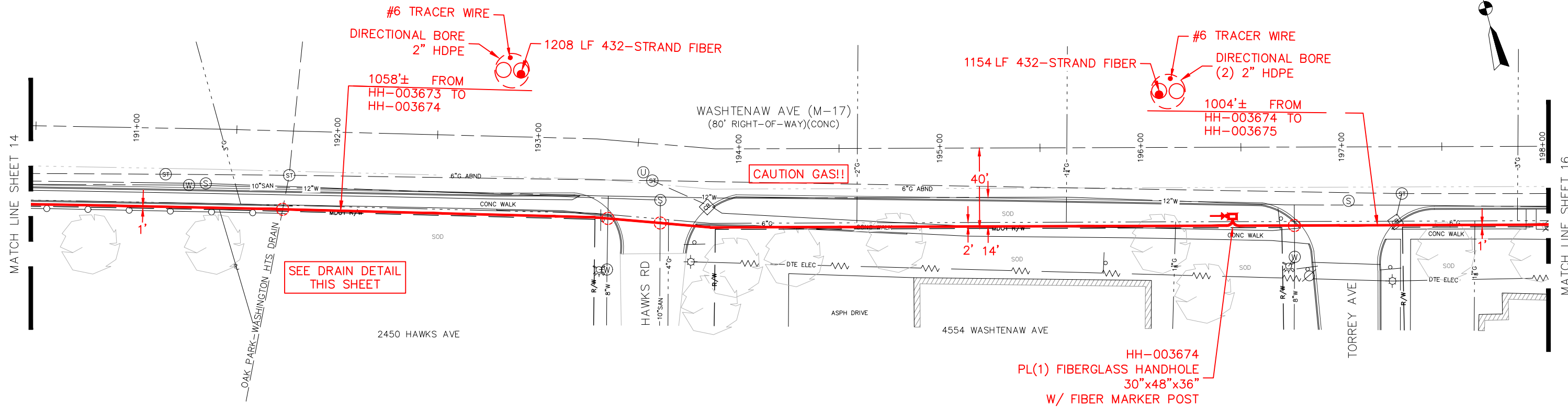
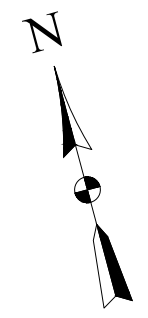

SEE DRAIN DETAIL
THIS SHEET

CAUTION GAS!!

HH-003674
PL(1) FIBERGLASS HANDHOLE
30"x48"x36"
W/ FIBER MARKER POST

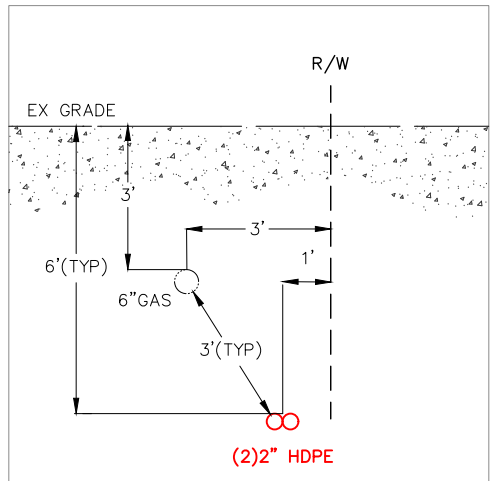

TYPICAL BORE SECTION
LOOKING EAST
STA 164+00 - STA 204+50
NOT TO SCALE

- BORE SECTION NOTES:
1. CONTRACTOR TO VERIFY DEPTH OF 6" STEEL GAS MAIN
 2. ADJUST DEPTH AT UTILITY CROSSINGS AS REQUIRED

REVISION		
REV #	DATE	DESCRIPTION
01	05/30/23	ADDED DRAIN DETAIL SHT 15. CORRECTED DRAIN NAME SHT 26
02	06/22/23	ADD WTR DIM PER PITTSFIELD, CORRECTED 6" WTR SHT 18
03	06/30/23	ADD WTR & SAN SRV SHTS 10,17&18. DEPTH NOTE SHT 18
04	08/30/23	REV PER CITY OF YPSI COMMENTS. ADD SHTS 38 & 39



THE LOCATIONS OF EXISTING UNDERGROUND UTILITIES ARE SHOWN IN AN APPROXIMATE WAY ONLY AND HAVE NOT BEEN INDEPENDENTLY VERIFIED. THE CONTRACTOR SHALL DETERMINE THE EXACT LOCATION OF ALL EXISTING UTILITIES BEFORE COMMENCING WORK, AND AGREES TO BE FULLY RESPONSIBLE FOR ANY AND ALL DAMAGES WHICH MIGHT BE OCCASIONED BY THE CONTRACTOR'S FAILURE TO EXACTLY LOCATE AND PRESERVE ANY AND ALL UNDERGROUND UTILITIES.

METRO ENGINEERING SOLUTIONS
33900 SCHOOLCRAFT RD
LIVONIA, MICHIGAN 48150
PHONE: 734.483.1427 FAX: 734.483.3431
www.metroes.net

NORTH ROUTE - EAST OF U.S. 23	
MES JOB# 1043-22	DRAWN - KMM
PLOT SCALE = 1" = 50'	CHECKED - JB
PLAN DATE = 05/11/2023	

ANN ARBOR SPARK
CORRIDOR FIBER OPTIC BACKBONE PROJECT
ANN ARBOR
WASHTENAW COUNTY, MI

PERMITS REQUIRED:

<input type="checkbox"/> CITY OF ANN ARBOR	<input checked="" type="checkbox"/> CITY OF YPSILANTI	<input type="checkbox"/> EGLE
<input checked="" type="checkbox"/> WASHTENAW COUNTY	<input checked="" type="checkbox"/> YPSILANTI TOWNSHIP	<input type="checkbox"/> RR
<input checked="" type="checkbox"/> WASHTENAW COUNTY DRAIN	<input checked="" type="checkbox"/> PITTSFIELD TOWNSHIP	<input checked="" type="checkbox"/> MDOT

SHEET INFORMATION

TOTAL SHEETS	SHEET NO.
39	15

K:\2022\1043 JOB FOLDERS\1043-22-0326\DWG\1043-22-0326_DS.dwg; 6/30/2023 10:32 AM;

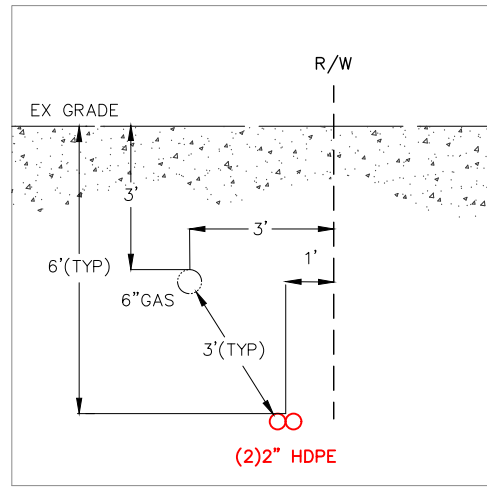
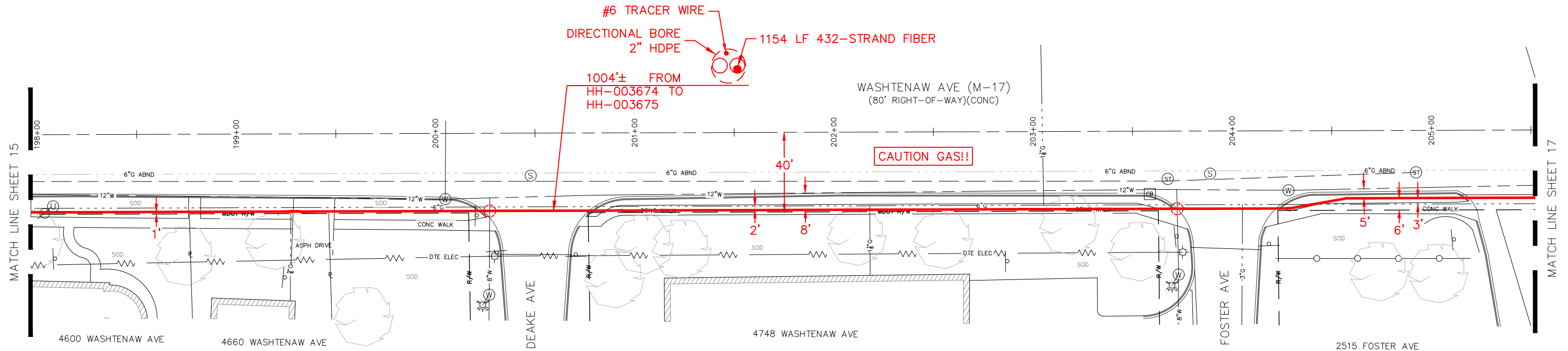
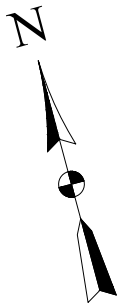

TYPICAL BORE SECTION
LOOKING EAST
STA 164+00 - STA 204+50
NOT TO SCALE

- BORE SECTION NOTES:
1. CONTRACTOR TO VERIFY DEPTH OF 6" STEEL GAS MAIN
 2. ADJUST DEPTH AT UTILITY CROSSINGS AS REQUIRED

REVISION		
REV #	DATE	DESCRIPTION
01	05/30/23	ADDED DRAIN DETAIL SHT 15. CORRECTED DRAIN NAME SHT 26
02	06/22/23	ADD WTR DIM PER PITTSFIELD, CORRECTED 6" WTR SHT 18
03	06/30/23	ADD WTR & SAN SRV SHTS 10,17&18. DEPTH NOTE SHT 18
04	08/30/23	REV PER CITY OF YPSI COMMENTS. ADD SHTS 38 & 39



THE LOCATIONS OF EXISTING UNDERGROUND UTILITIES ARE SHOWN IN AN APPROXIMATE WAY ONLY AND HAVE NOT BEEN INDEPENDENTLY VERIFIED. THE CONTRACTOR SHALL DETERMINE THE EXACT LOCATION OF ALL EXISTING UTILITIES BEFORE COMMENCING WORK, AND AGREES TO BE FULLY RESPONSIBLE FOR ANY AND ALL DAMAGES WHICH MIGHT BE OCCASIONED BY THE CONTRACTOR'S FAILURE TO EXACTLY LOCATE AND PRESERVE ANY AND ALL UNDERGROUND UTILITIES.

METRO ENGINEERING SOLUTIONS
33900 SCHOOLCRAFT RD
LIVONIA, MICHIGAN 48150
PHONE: 734.483.1427 FAX: 734.483.3431
www.metroes.net

NORTH ROUTE - EAST OF U.S. 23	
MES JOB# 1043-22	DRAWN - KMM
PLOT SCALE = 1" = 50'	CHECKED - JB
PLAN DATE = 05/11/2023	

ANN ARBOR SPARK
CORRIDOR FIBER OPTIC BACKBONE PROJECT
ANN ARBOR
WASHTENAW COUNTY, MI

PERMITS REQUIRED:

<input type="checkbox"/> CITY OF ANN ARBOR	<input checked="" type="checkbox"/> CITY OF YPSILANTI	<input type="checkbox"/> EGLE
<input checked="" type="checkbox"/> WASHTENAW COUNTY	<input checked="" type="checkbox"/> YPSILANTI TOWNSHIP	<input type="checkbox"/> RR
<input checked="" type="checkbox"/> WASHTENAW COUNTY DRAIN	<input checked="" type="checkbox"/> PITTSFIELD TOWNSHIP	<input checked="" type="checkbox"/> MDOT

SHEET INFORMATION

TOTAL SHEETS	SHEET NO.
39	16

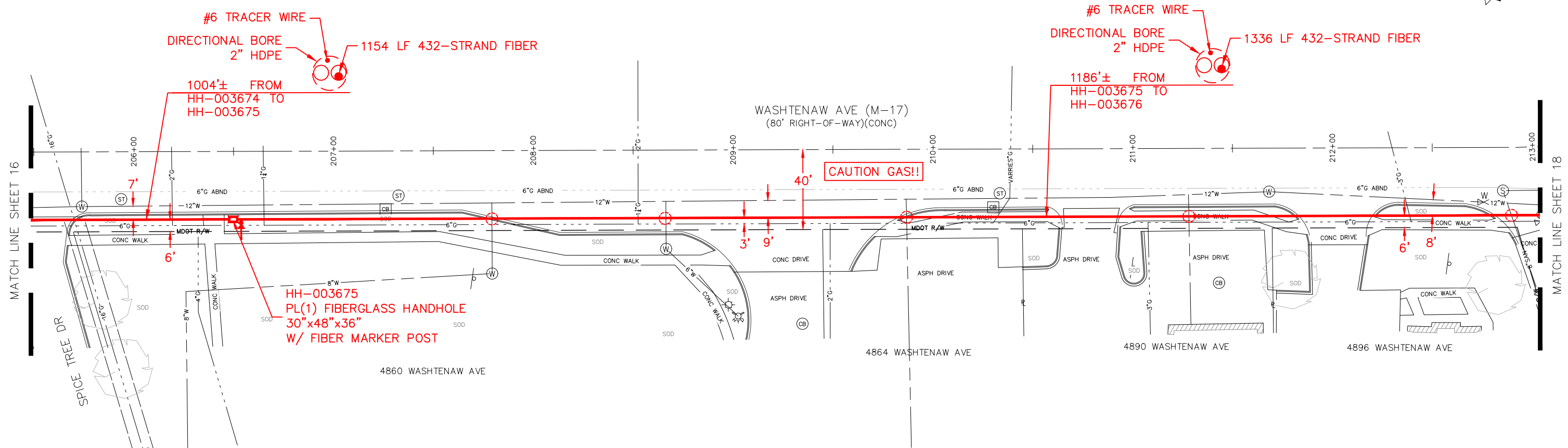
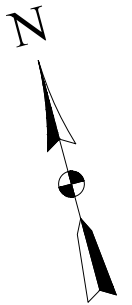

K:\2022\1043 JOB FOLDERS\1043-22-0326\DWG\1043-22-0326_DS.dwg; 6/30/2023 10:32 AM;



THE LOCATIONS OF EXISTING UNDERGROUND UTILITIES ARE SHOWN IN AN APPROXIMATE WAY ONLY AND HAVE NOT BEEN INDEPENDENTLY VERIFIED. THE CONTRACTOR SHALL DETERMINE THE EXACT LOCATION OF ALL EXISTING UTILITIES BEFORE COMMENCING WORK, AND AGREES TO BE FULLY RESPONSIBLE FOR ANY AND ALL DAMAGES WHICH MIGHT BE OCCASIONED BY THE CONTRACTOR'S FAILURE TO EXACTLY LOCATE AND PRESERVE ANY AND ALL UNDERGROUND UTILITIES.

METRO ENGINEERING SOLUTIONS
33900 SCHOOLCRAFT RD
LIVONIA, MICHIGAN 48150
PHONE: 734.483.1427 FAX: 734.483.3431
www.metroes.net

NORTH ROUTE - EAST OF U.S. 23	
MES JOB# 1043-22	DRAWN — KMM
PLOT SCALE = 1" = 50'	CHECKED - JB
PLAN DATE = 05/11/2023	

ANN ARBOR SPARK
CORRIDOR FIBER OPTIC BACKBONE PROJECT
ANN ARBOR
WASHTENAW COUNTY, MI

PERMITS REQUIRED:		
<input type="checkbox"/> CITY OF ANN ARBOR	<input checked="" type="checkbox"/> CITY OF YPSILANTI	<input type="checkbox"/> EGLE
<input checked="" type="checkbox"/> WASHTENAW COUNTY	<input checked="" type="checkbox"/> YPSILANTI TOWNSHIP	<input type="checkbox"/> RR
<input checked="" type="checkbox"/> WASHTENAW COUNTY DRAIN	<input checked="" type="checkbox"/> PITTSFIELD TOWNSHIP	<input checked="" type="checkbox"/> MDOT

SHEET INFORMATION	
TOTAL SHEETS	SHEET NO.
39	17

REVISION		
REV #	DATE	DESCRIPTION
01	05/30/23	ADDED DRAIN DETAIL SHT 15. CORRECTED DRAIN NAME SHT 26
02	06/22/23	ADD WTR DIM PER PITTSFIELD, CORRECTED 6" WTR SHT 18
03	06/30/23	ADD WTR & SAN SRV SHTS 10,17&18. DEPTH NOTE SHT 18
04	08/30/23	REV PER CITY OF YPSI COMMENTS. ADD SHTS 38 & 39

PITTSFIELD TOWNSHIP
SEC:01 T:03S R:06E

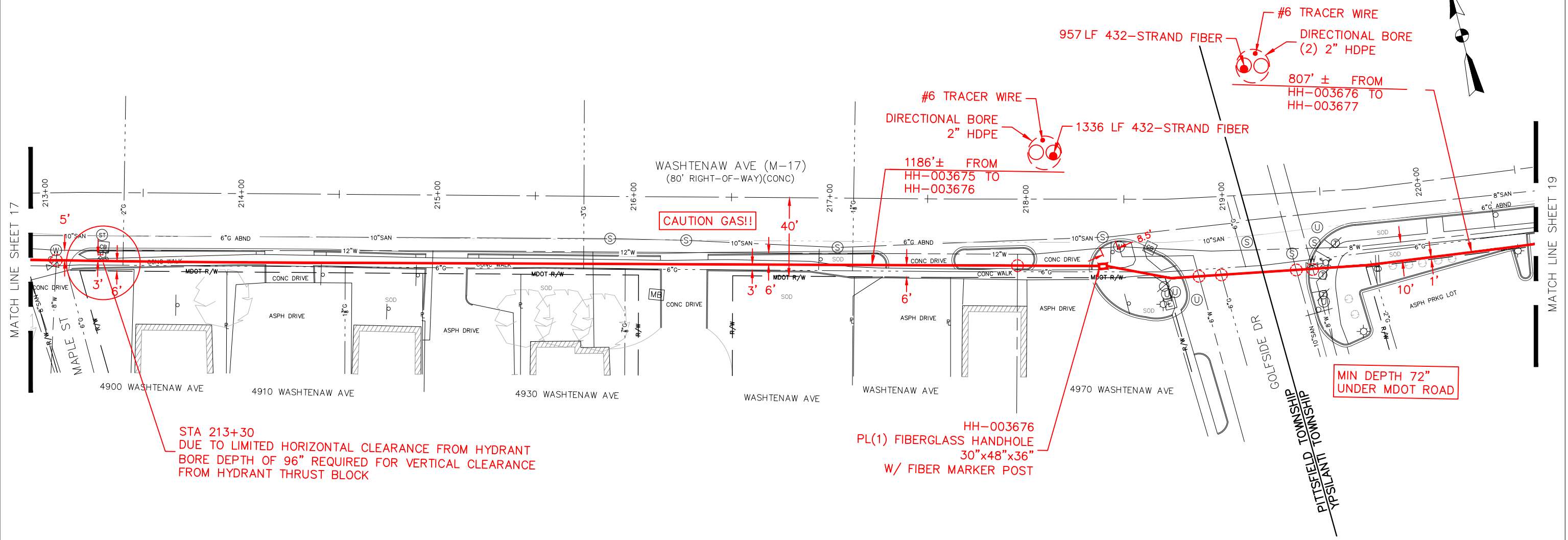
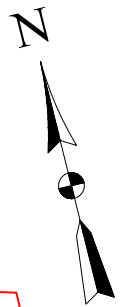

STA 213+30
DUE TO LIMITED HORIZONTAL CLEARANCE FROM HYDRANT
BORE DEPTH OF 96" REQUIRED FOR VERTICAL CLEARANCE
FROM HYDRANT THRUST BLOCK

CAUTION GAS!!

MIN DEPTH 72"
UNDER MDOT ROAD

HH-003676
PL(1) FIBERGLASS HANDHOLE
30"x48"x36"
W/ FIBER MARKER POST

K:\2022\1043 JOB FOLDERS\1043-22-0326\DWG\1043-22-0326_DS.dwg; 6/30/2023 10:32 AM;



THE LOCATIONS OF EXISTING UNDERGROUND UTILITIES ARE SHOWN IN AN APPROXIMATE WAY ONLY AND HAVE NOT BEEN INDEPENDENTLY VERIFIED. THE CONTRACTOR SHALL DETERMINE THE EXACT LOCATION OF ALL EXISTING UTILITIES BEFORE COMMENCING WORK, AND AGREES TO BE FULLY RESPONSIBLE FOR ANY AND ALL DAMAGES WHICH MIGHT BE OCCASIONED BY THE CONTRACTOR'S FAILURE TO EXACTLY LOCATE AND PRESERVE ANY AND ALL UNDERGROUND UTILITIES.

METRO ENGINEERING SOLUTIONS
33900 SCHOOLCRAFT RD
LIVONIA, MICHIGAN 48150
PHONE: 734.483.1427 FAX: 734.483.3431
www.metroes.net

NORTH ROUTE - EAST OF U.S. 23	
MES JOB# 1043-22	DRAWN — KMM
PLOT SCALE = 1" = 50'	CHECKED - JB
PLAN DATE = 05/11/2023	

ANN ARBOR SPARK
CORRIDOR FIBER OPTIC BACKBONE PROJECT
ANN ARBOR
WASHTENAW COUNTY, MI

PERMITS REQUIRED:

<input type="checkbox"/> CITY OF ANN ARBOR	<input checked="" type="checkbox"/> CITY OF YPSILANTI	<input type="checkbox"/> EGLE
<input checked="" type="checkbox"/> WASHTENAW COUNTY	<input checked="" type="checkbox"/> YPSILANTI TOWNSHIP	<input type="checkbox"/> RR
<input checked="" type="checkbox"/> WASHTENAW COUNTY DRAIN	<input checked="" type="checkbox"/> PITTSFIELD TOWNSHIP	<input checked="" type="checkbox"/> MDOT

SHEET INFORMATION

TOTAL SHEETS	SHEET NO.
39	18

REVISION		
REV #	DATE	DESCRIPTION
01	05/30/23	ADDED DRAIN DETAIL SHT 15. CORRECTED DRAIN NAME SHT 26
02	06/22/23	ADD WTR DIM PER PITTSFIELD, CORRECTED 6" WTR SHT 18
03	06/30/23	ADD WTR & SAN SRV SHTS 10,17&18. DEPTH NOTE SHT 18
04	08/30/23	REV PER CITY OF YPSI COMMENTS. ADD SHTS 38 & 39

YPSILANTI TOWNSHIP
SEC:06 T:03S R:07E

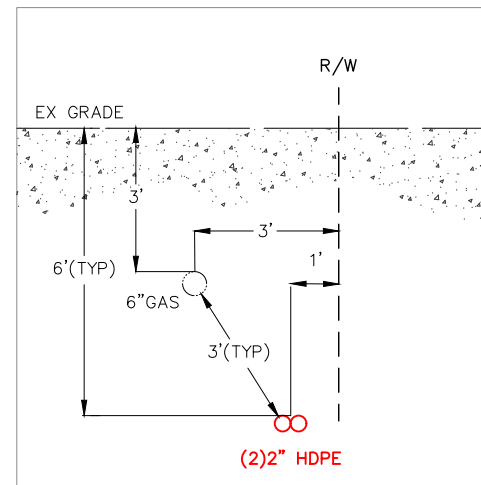
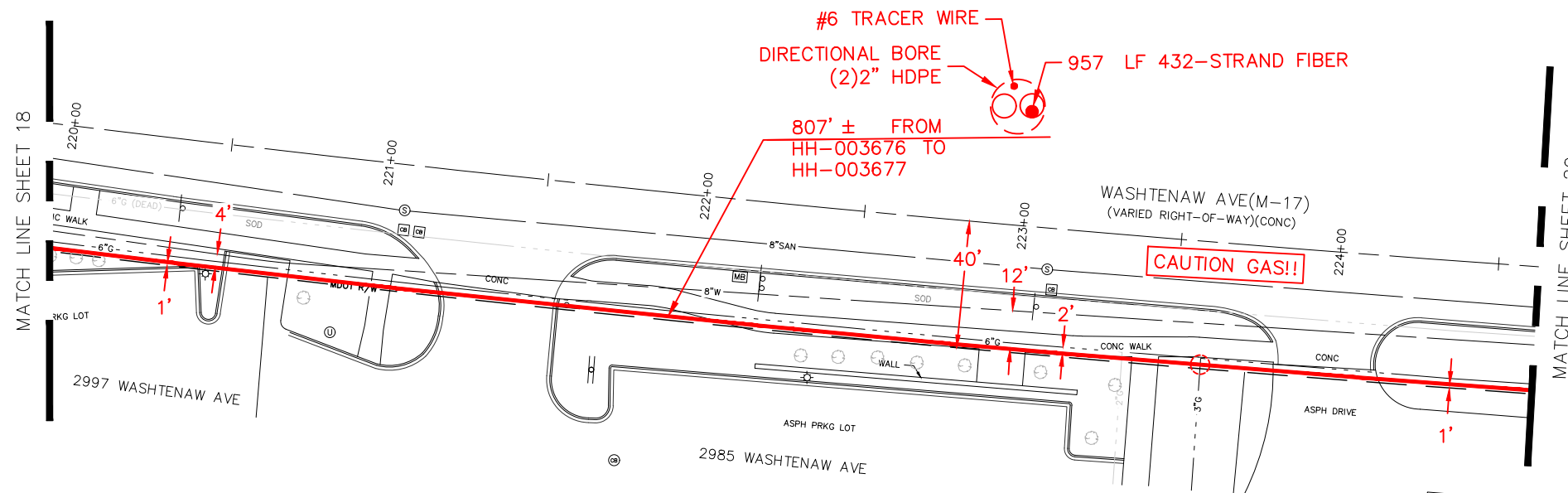

- BORE SECTION NOTES:**
1. CONTRACTOR TO VERIFY DEPTH OF 6" STEEL GAS MAIN
 2. ADJUST DEPTH AT UTILITY CROSSINGS AS REQUIRED

TYPICAL BORE SECTION
LOOKING EAST
STA 220+00 - STA 257+00
NOT TO SCALE

REVISION		
REV #	DATE	DESCRIPTION
01	05/30/23	ADDED DRAIN DETAIL SHT 15. CORRECTED DRAIN NAME SHT 26
02	06/22/23	ADD WTR DIM PER PITTSFIELD, CORRECTED 6" WTR SHT 18
03	06/30/23	ADD WTR & SAN SRV SHTS 10,17&18. DEPTH NOTE SHT 18
04	08/30/23	REV PER CITY OF YPSI COMMENTS. ADD SHTS 38 & 39



Call before you dig.

THE LOCATIONS OF EXISTING UNDERGROUND UTILITIES ARE SHOWN IN AN APPROXIMATE WAY ONLY AND HAVE NOT BEEN INDEPENDENTLY VERIFIED. THE CONTRACTOR SHALL DETERMINE THE EXACT LOCATION OF ALL EXISTING UTILITIES BEFORE COMMENCING WORK, AND AGREES TO BE FULLY RESPONSIBLE FOR ANY AND ALL DAMAGES WHICH MIGHT BE OCCASIONED BY THE CONTRACTOR'S FAILURE TO EXACTLY LOCATE AND PRESERVE ANY AND ALL UNDERGROUND UTILITIES.



33900 SCHOOLCRAFT RD
LIVONIA, MICHIGAN 48150
PHONE: 734.483.1427 FAX: 734.483.3431
www.metroes.net

NORTH ROUTE - EAST OF U.S. 23	
MES JOB# 1043-22	DRAWN - KMM
PLOT SCALE = 1" = 50'	CHECKED - JB
PLAN DATE = 05/11/2023	

ANN ARBOR SPARK
CORRIDOR FIBER OPTIC BACKBONE PROJECT
ANN ARBOR
WASHTENAW COUNTY, MI

PERMITS REQUIRED:

<input type="checkbox"/> CITY OF ANN ARBOR	<input checked="" type="checkbox"/> CITY OF YPSILANTI	<input type="checkbox"/> EGLE
<input checked="" type="checkbox"/> WASHTENAW COUNTY	<input checked="" type="checkbox"/> YPSILANTI TOWNSHIP	<input type="checkbox"/> RR
<input checked="" type="checkbox"/> WASHTENAW COUNTY DRAIN	<input checked="" type="checkbox"/> PITTSFIELD TOWNSHIP	<input checked="" type="checkbox"/> MDOT

SHEET INFORMATION

TOTAL SHEETS	SHEET NO.
39	19

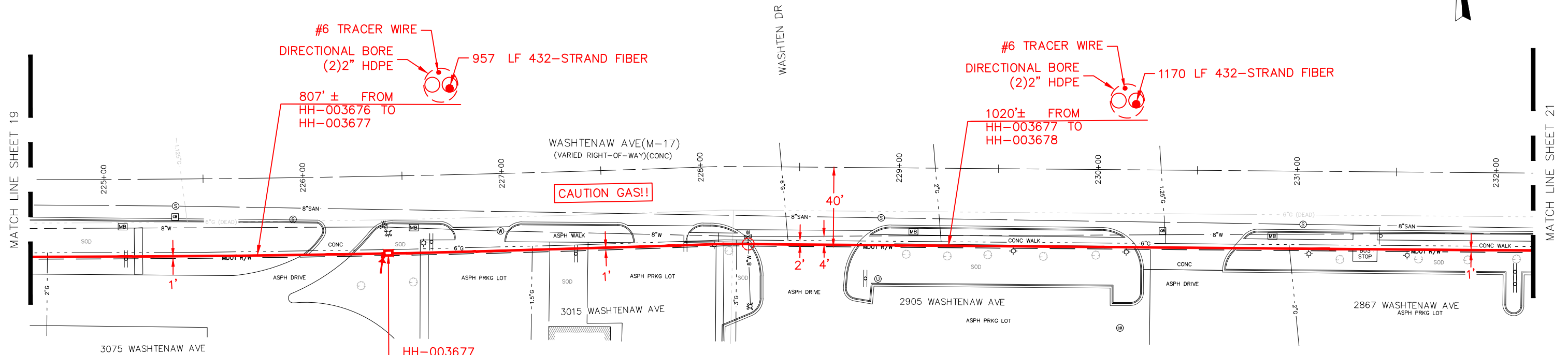
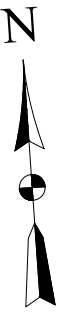

CAUTION GAS!!

HH-003677
PL(1) FIBERGLASS HANDHOLE
30"x48"x36"
W/ FIBER MARKER POST

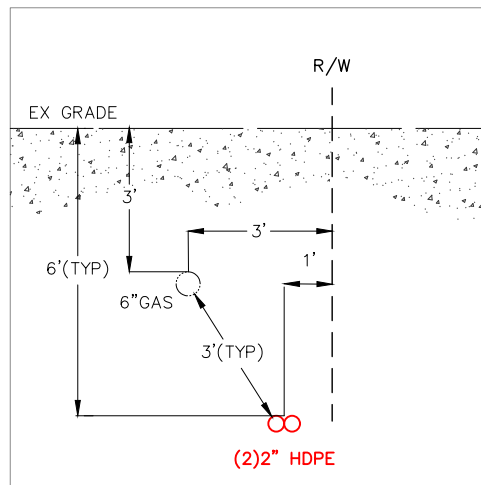

TYPICAL BORE SECTION
LOOKING EAST
STA 220+00 - STA 257+00
NOT TO SCALE

- BORE SECTION NOTES:**
- CONTRACTOR TO VERIFY DEPTH OF 6" STEEL GAS MAIN
 - ADJUST DEPTH AT UTILITY CROSSINGS AS REQUIRED

REVISION		
REV #	DATE	DESCRIPTION
01	05/30/23	ADDED DRAIN DETAIL SHT 15. CORRECTED DRAIN NAME SHT 26
02	06/22/23	ADD WTR DIM PER PITTSFIELD, CORRECTED 6" WTR SHT 18
03	06/30/23	ADD WTR & SAN SRV SHTS 10,17&18. DEPTH NOTE SHT 18
04	08/30/23	REV PER CITY OF YPSI COMMENTS. ADD SHTS 38 & 39



THE LOCATIONS OF EXISTING UNDERGROUND UTILITIES ARE SHOWN IN AN APPROXIMATE WAY ONLY AND HAVE NOT BEEN INDEPENDENTLY VERIFIED. THE CONTRACTOR SHALL DETERMINE THE EXACT LOCATION OF ALL EXISTING UTILITIES BEFORE COMMENCING WORK, AND AGREES TO BE FULLY RESPONSIBLE FOR ANY AND ALL DAMAGES WHICH MIGHT BE OCCASIONED BY THE CONTRACTOR'S FAILURE TO EXACTLY LOCATE AND PRESERVE ANY AND ALL UNDERGROUND UTILITIES.



33900 SCHOOLCRAFT RD
LIVONIA, MICHIGAN 48150
PHONE: 734.483.1427 FAX: 734.483.3431
www.metroes.net

NORTH ROUTE - EAST OF U.S. 23	
MES JOB# 1043-22	DRAWN - KMM
PLOT SCALE = 1" = 50'	CHECKED - JB
PLAN DATE = 05/11/2023	

ANN ARBOR SPARK	
CORRIDOR FIBER OPTIC BACKBONE PROJECT	
ANN ARBOR	
WASHTENAW COUNTY, MI	

PERMITS REQUIRED:		
<input type="checkbox"/> CITY OF ANN ARBOR	<input checked="" type="checkbox"/> CITY OF YPSILANTI	<input type="checkbox"/> EGLE
<input checked="" type="checkbox"/> WASHTENAW COUNTY	<input checked="" type="checkbox"/> YPSILANTI TOWNSHIP	<input type="checkbox"/> RR
<input checked="" type="checkbox"/> WASHTENAW COUNTY DRAIN	<input checked="" type="checkbox"/> PITTSFIELD TOWNSHIP	<input checked="" type="checkbox"/> MDOT

SHEET INFORMATION	
TOTAL SHEETS	SHEET NO.
39	20

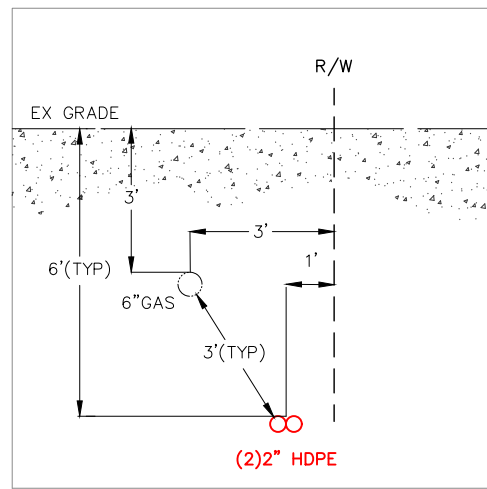
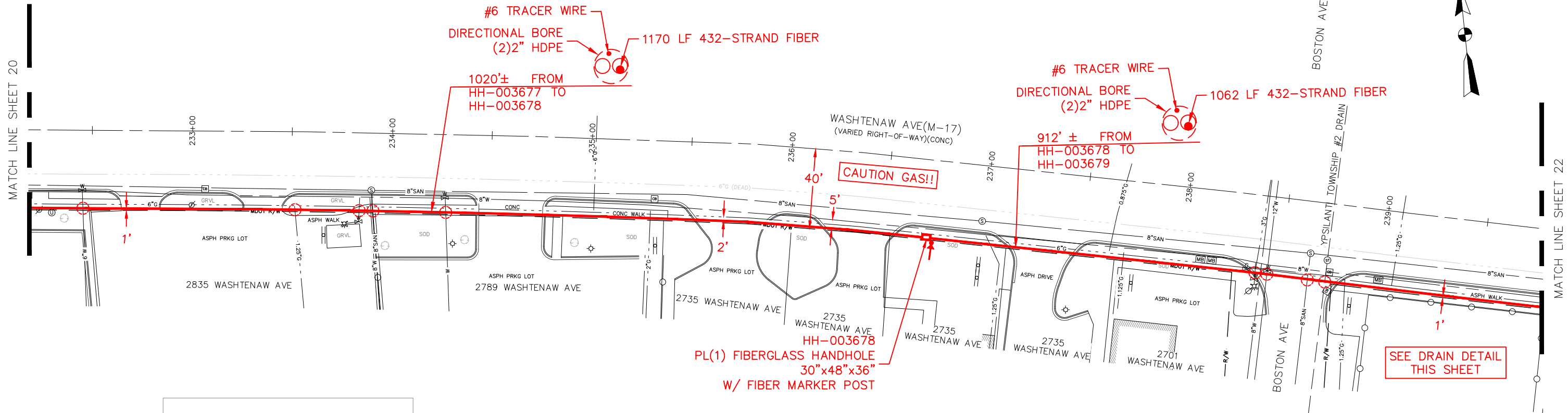
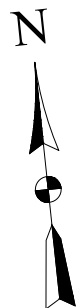

- BORE SECTION NOTES:**
1. CONTRACTOR TO VERIFY DEPTH OF 6" STEEL GAS MAIN
 2. ADJUST DEPTH AT UTILITY CROSSINGS AS REQUIRED

TYPICAL BORE SECTION
LOOKING EAST
STA 220+00 - STA 257+00
NOT TO SCALE

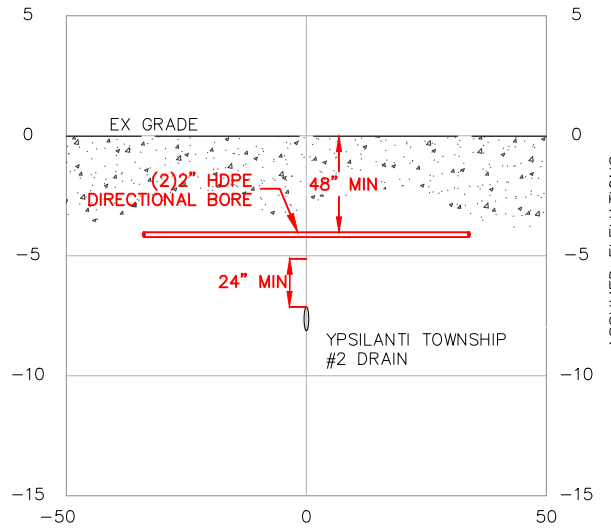

DRAIN CROSSING DETAIL
YPSILANTI TOWNSHIP #2 DRAIN
STA 238+73
NOT TO SCALE

REVISION		
REV #	DATE	DESCRIPTION
01	05/30/23	ADDED DRAIN DETAIL SHT 15. CORRECTED DRAIN NAME SHT 26
02	06/22/23	ADD WTR DIM PER PITTSFIELD, CORRECTED 6" WTR SHT 18
03	06/30/23	ADD WTR & SAN SRV SHTS 10,17&18. DEPTH NOTE SHT 18
04	08/30/23	REV PER CITY OF YPSI COMMENTS. ADD SHTS 38 & 39



THE LOCATIONS OF EXISTING UNDERGROUND UTILITIES ARE SHOWN IN AN APPROXIMATE WAY ONLY AND HAVE NOT BEEN INDEPENDENTLY VERIFIED. THE CONTRACTOR SHALL DETERMINE THE EXACT LOCATION OF ALL EXISTING UTILITIES BEFORE COMMENCING WORK, AND AGREES TO BE FULLY RESPONSIBLE FOR ANY AND ALL DAMAGES WHICH MIGHT BE OCCASIONED BY THE CONTRACTOR'S FAILURE TO EXACTLY LOCATE AND PRESERVE ANY AND ALL UNDERGROUND UTILITIES.



33900 SCHOOLCRAFT RD
LIVONIA, MICHIGAN 48150
PHONE: 734.483.1427 FAX: 734.483.3431
www.metroes.net

NORTH ROUTE - EAST OF U.S. 23	
MES JOB#	1043-22
DRAWN	KMM
PLOT SCALE	1" = 50'
CHECKED	JB
PLAN DATE	05/11/2023

ANN ARBOR SPARK
CORRIDOR FIBER OPTIC BACKBONE PROJECT
ANN ARBOR
WASHTENAW COUNTY, MI

PERMITS REQUIRED:

<input type="checkbox"/> CITY OF ANN ARBOR	<input checked="" type="checkbox"/> CITY OF YPSILANTI	<input type="checkbox"/> EGLE
<input checked="" type="checkbox"/> WASHTENAW COUNTY	<input checked="" type="checkbox"/> YPSILANTI TOWNSHIP	<input type="checkbox"/> RR
<input checked="" type="checkbox"/> WASHTENAW COUNTY DRAIN	<input checked="" type="checkbox"/> PITTSFIELD TOWNSHIP	<input checked="" type="checkbox"/> MDOT

SHEET INFORMATION

TOTAL SHEETS	SHEET NO.
39	21

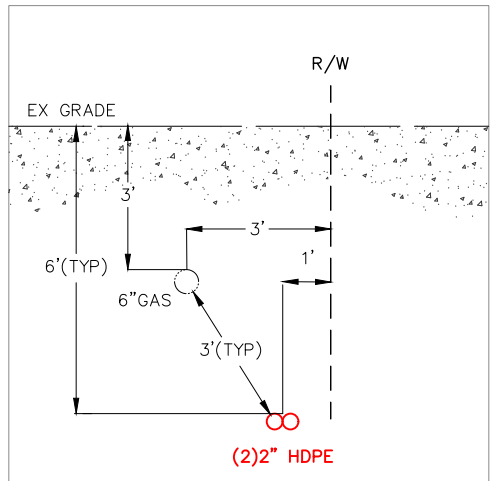
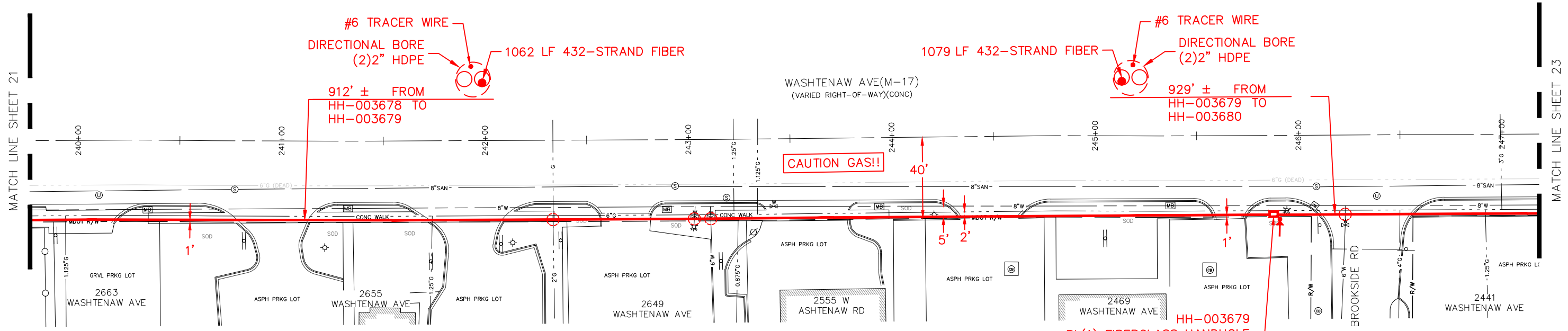
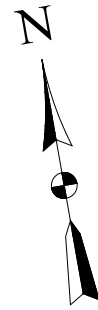

- BORE SECTION NOTES:**
1. CONTRACTOR TO VERIFY DEPTH OF 6" STEEL GAS MAIN
 2. ADJUST DEPTH AT UTILITY CROSSINGS AS REQUIRED

TYPICAL BORE SECTION
LOOKING EAST
STA 220+00 - STA 257+00
NOT TO SCALE

HH-003679
PL(1) FIBERGLASS HANDHOLE
30"x48"x36"
W/ FIBER MARKER POST

REVISION		
REV #	DATE	DESCRIPTION
01	05/30/23	ADDED DRAIN DETAIL SHT 15. CORRECTED DRAIN NAME SHT 26
02	06/22/23	ADD WTR DIM PER PITTSFIELD, CORRECTED 6" WTR SHT 18
03	06/30/23	ADD WTR & SAN SRV SHTS 10,17&18. DEPTH NOTE SHT 18
04	08/30/23	REV PER CITY OF YPSI COMMENTS. ADD SHTS 38 & 39



THE LOCATIONS OF EXISTING UNDERGROUND UTILITIES ARE SHOWN IN AN APPROXIMATE WAY ONLY AND HAVE NOT BEEN INDEPENDENTLY VERIFIED. THE CONTRACTOR SHALL DETERMINE THE EXACT LOCATION OF ALL EXISTING UTILITIES BEFORE COMMENCING WORK, AND AGREES TO BE FULLY RESPONSIBLE FOR ANY AND ALL DAMAGES WHICH MIGHT BE OCCASIONED BY THE CONTRACTOR'S FAILURE TO EXACTLY LOCATE AND PRESERVE ANY AND ALL UNDERGROUND UTILITIES.

METRO ENGINEERING SOLUTIONS
33900 SCHOOLCRAFT RD
LIVONIA, MICHIGAN 48150
PHONE: 734.483.1427 FAX: 734.483.3431
www.metroes.net

NORTH ROUTE - EAST OF U.S. 23	
MES JOB# 1043-22	DRAWN - KMM
PLOT SCALE = 1" = 50'	CHECKED - JB
PLAN DATE = 05/11/2023	

ANN ARBOR SPARK
CORRIDOR FIBER OPTIC BACKBONE PROJECT
ANN ARBOR
WASHTENAW COUNTY, MI

PERMITS REQUIRED:		
<input type="checkbox"/> CITY OF ANN ARBOR	<input checked="" type="checkbox"/> CITY OF YPSILANTI	<input type="checkbox"/> EGLE
<input checked="" type="checkbox"/> WASHTENAW COUNTY	<input checked="" type="checkbox"/> YPSILANTI TOWNSHIP	<input type="checkbox"/> RR
<input checked="" type="checkbox"/> WASHTENAW COUNTY DRAIN	<input checked="" type="checkbox"/> PITTSFIELD TOWNSHIP	<input checked="" type="checkbox"/> MDOT

SHEET INFORMATION	
TOTAL SHEETS	SHEET NO.
39	22

K:\2022\1043 JOB FOLDERS\1043-22-0327\DWG\1043-22-0327_DS.dwg; 5/30/2023 1:00 PM;

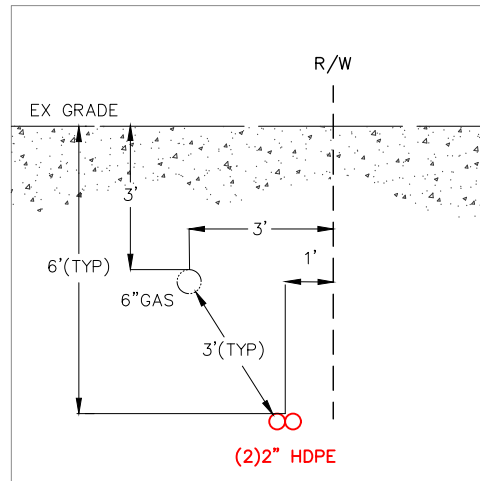
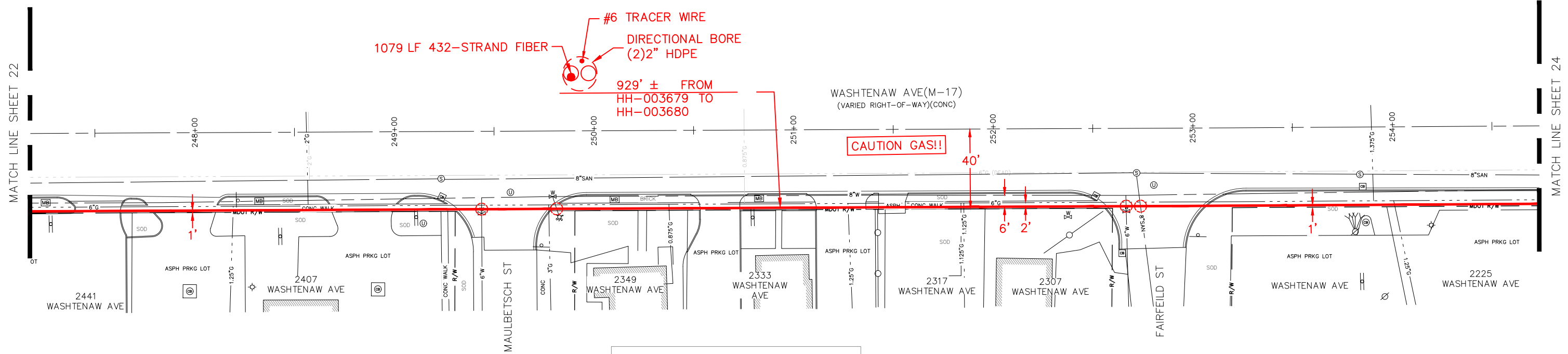
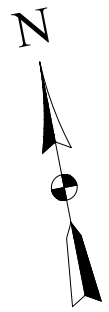

- BORE SECTION NOTES:**
1. CONTRACTOR TO VERIFY DEPTH OF 6" STEEL GAS MAIN
 2. ADJUST DEPTH AT UTILITY CROSSINGS AS REQUIRED

TYPICAL BORE SECTION
LOOKING EAST
STA 220+00 - STA 257+00
NOT TO SCALE

REVISION		
REV #	DATE	DESCRIPTION
01	05/30/23	ADDED DRAIN DETAIL SHT 15. CORRECTED DRAIN NAME SHT 26
02	06/22/23	ADD WTR DIM PER PITTSFIELD, CORRECTED 6" WTR SHT 18
03	06/30/23	ADD WTR & SAN SRV SHTS 10,17&18. DEPTH NOTE SHT 18
04	08/30/23	REV PER CITY OF YPSI COMMENTS. ADD SHTS 38 & 39



THE LOCATIONS OF EXISTING UNDERGROUND UTILITIES ARE SHOWN IN AN APPROXIMATE WAY ONLY AND HAVE NOT BEEN INDEPENDENTLY VERIFIED. THE CONTRACTOR SHALL DETERMINE THE EXACT LOCATION OF ALL EXISTING UTILITIES BEFORE COMMENCING WORK, AND AGREES TO BE FULLY RESPONSIBLE FOR ANY AND ALL DAMAGES WHICH MIGHT BE OCCASIONED BY THE CONTRACTOR'S FAILURE TO EXACTLY LOCATE AND PRESERVE ANY AND ALL UNDERGROUND UTILITIES.

METRO ENGINEERING SOLUTIONS
33900 SCHOOLCRAFT RD
LIVONIA, MICHIGAN 48150
PHONE: 734.483.1427 FAX: 734.483.3431
www.metroes.net

NORTH ROUTE - EAST OF U.S. 23	
MES JOB# 1043-22	DRAWN - KMM
PLOT SCALE = 1" = 50'	CHECKED - JB
PLAN DATE = 05/11/2023	

ANN ARBOR SPARK
CORRIDOR FIBER OPTIC BACKBONE PROJECT
ANN ARBOR
WASHTENAW COUNTY, MI

PERMITS REQUIRED:

<input type="checkbox"/> CITY OF ANN ARBOR	<input checked="" type="checkbox"/> CITY OF YPSILANTI	<input type="checkbox"/> EGLE
<input checked="" type="checkbox"/> WASHTENAW COUNTY	<input checked="" type="checkbox"/> YPSILANTI TOWNSHIP	<input type="checkbox"/> RR
<input checked="" type="checkbox"/> WASHTENAW COUNTY DRAIN	<input checked="" type="checkbox"/> PITTSFIELD TOWNSHIP	<input checked="" type="checkbox"/> MDOT

SHEET INFORMATION

TOTAL SHEETS	SHEET NO.
39	23

K:\2022\1043 JOB FOLDERS\1043-22-0327\DWG\1043-22-0327_DS.dwg; 5/30/2023 1:00 PM;

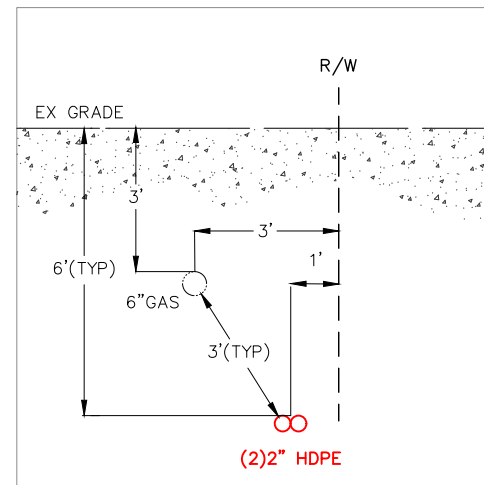
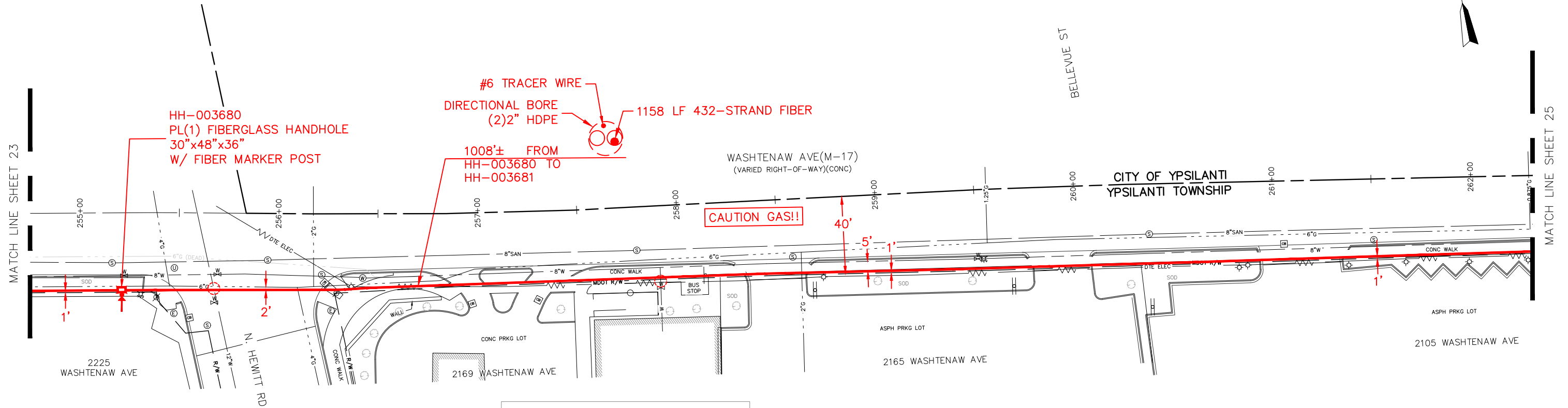
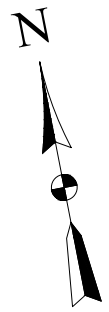

- BORE SECTION NOTES:**
1. CONTRACTOR TO VERIFY DEPTH OF 6" STEEL GAS MAIN
 2. ADJUST DEPTH AT UTILITY CROSSINGS AS REQUIRED

TYPICAL BORE SECTION
LOOKING EAST
STA 220+00 - STA 257+00
NOT TO SCALE

REVISION		
REV #	DATE	DESCRIPTION
01	05/30/23	ADDED DRAIN DETAIL SHT 15. CORRECTED DRAIN NAME SHT 26
02	06/22/23	ADD WTR DIM PER PITTSFIELD, CORRECTED 6" WTR SHT 18
03	06/30/23	ADD WTR & SAN SRV SHTS 10,17&18. DEPTH NOTE SHT 18
04	08/30/23	REV PER CITY OF YPSI COMMENTS. ADD SHTS 38 & 39



THE LOCATIONS OF EXISTING UNDERGROUND UTILITIES ARE SHOWN IN AN APPROXIMATE WAY ONLY AND HAVE NOT BEEN INDEPENDENTLY VERIFIED. THE CONTRACTOR SHALL DETERMINE THE EXACT LOCATION OF ALL EXISTING UTILITIES BEFORE COMMENCING WORK, AND AGREES TO BE FULLY RESPONSIBLE FOR ANY AND ALL DAMAGES WHICH MIGHT BE OCCASIONED BY THE CONTRACTOR'S FAILURE TO EXACTLY LOCATE AND PRESERVE ANY AND ALL UNDERGROUND UTILITIES.



33900 SCHOOLCRAFT RD
LIVONIA, MICHIGAN 48150
PHONE: 734.483.1427 FAX: 734.483.3431
www.metroes.net

NORTH ROUTE - EAST OF U.S. 23	
MES JOB# 1043-22	DRAWN - KMM
PLOT SCALE = 1" = 50'	CHECKED - JB
PLAN DATE = 05/11/2023	

ANN ARBOR SPARK
CORRIDOR FIBER OPTIC BACKBONE PROJECT
ANN ARBOR
WASHTENAW COUNTY, MI

PERMITS REQUIRED:		
<input type="checkbox"/> CITY OF ANN ARBOR	<input checked="" type="checkbox"/> CITY OF YPSILANTI	<input type="checkbox"/> EGLE
<input checked="" type="checkbox"/> WASHTENAW COUNTY	<input checked="" type="checkbox"/> YPSILANTI TOWNSHIP	<input type="checkbox"/> RR
<input checked="" type="checkbox"/> WASHTENAW COUNTY DRAIN	<input checked="" type="checkbox"/> PITTSFIELD TOWNSHIP	<input checked="" type="checkbox"/> MDOT

SHEET INFORMATION	
TOTAL SHEETS	SHEET NO.
39	24

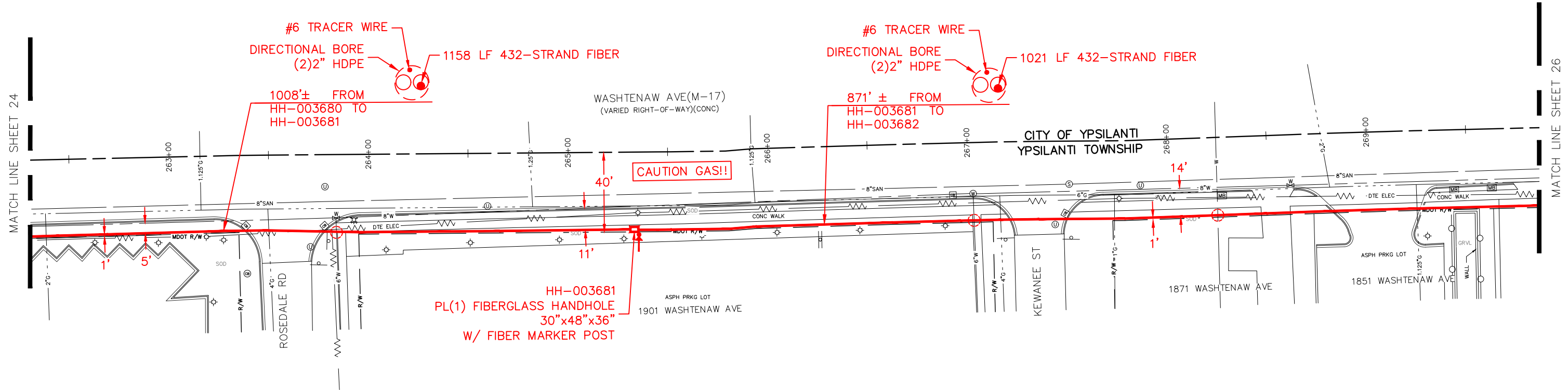
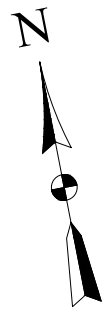

Call before you dig.

THE LOCATIONS OF EXISTING UNDERGROUND UTILITIES ARE SHOWN IN AN APPROXIMATE WAY ONLY AND HAVE NOT BEEN INDEPENDENTLY VERIFIED. THE CONTRACTOR SHALL DETERMINE THE EXACT LOCATION OF ALL EXISTING UTILITIES BEFORE COMMENCING WORK, AND AGREES TO BE FULLY RESPONSIBLE FOR ANY AND ALL DAMAGES WHICH MIGHT BE OCCASIONED BY THE CONTRACTOR'S FAILURE TO EXACTLY LOCATE AND PRESERVE ANY AND ALL UNDERGROUND UTILITIES.

METRO ENGINEERING SOLUTIONS
33900 SCHOOLCRAFT RD
LIVONIA, MICHIGAN 48150
PHONE: 734.483.1427 FAX: 734.483.3431
www.metroes.net

NORTH ROUTE - EAST OF U.S. 23	
MES JOB# 1043-22	DRAWN — KMM
PLOT SCALE = 1" = 50'	CHECKED - JB
PLAN DATE = 05/11/2023	

ANN ARBOR SPARK
CORRIDOR FIBER OPTIC BACKBONE PROJECT
ANN ARBOR
WASHTENAW COUNTY, MI

PERMITS REQUIRED:		
<input type="checkbox"/> CITY OF ANN ARBOR	<input checked="" type="checkbox"/> CITY OF YPSILANTI	<input type="checkbox"/> EGLE
<input checked="" type="checkbox"/> WASHTENAW COUNTY	<input checked="" type="checkbox"/> YPSILANTI TOWNSHIP	<input type="checkbox"/> RR
<input checked="" type="checkbox"/> WASHTENAW COUNTY DRAIN	<input checked="" type="checkbox"/> PITTSFIELD TOWNSHIP	<input checked="" type="checkbox"/> MDOT

SHEET INFORMATION	
TOTAL SHEETS	SHEET NO.
39	25

REVISION		
REV #	DATE	DESCRIPTION
01	05/30/23	ADDED DRAIN DETAIL SHT 15. CORRECTED DRAIN NAME SHT 26
02	06/22/23	ADD WTR DIM PER PITTSFIELD, CORRECTED 6" WTR SHT 18
03	06/30/23	ADD WTR & SAN SRV SHTS 10,17&18. DEPTH NOTE SHT 18
04	08/30/23	REV PER CITY OF YPSI COMMENTS. ADD SHTS 38 & 39

CITY OF YPSILANTI
SEC:05 T:03S R:07E

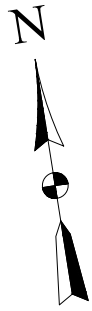

MATCH LINE SHEET 25

MATCH LINE SHEET 27

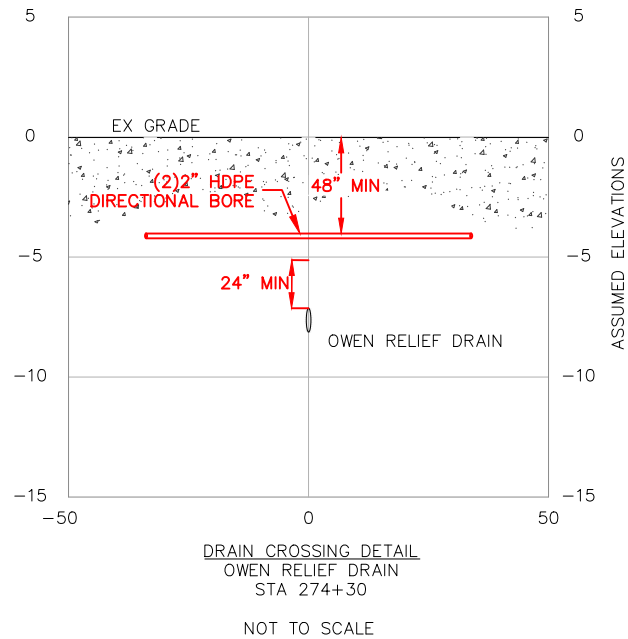
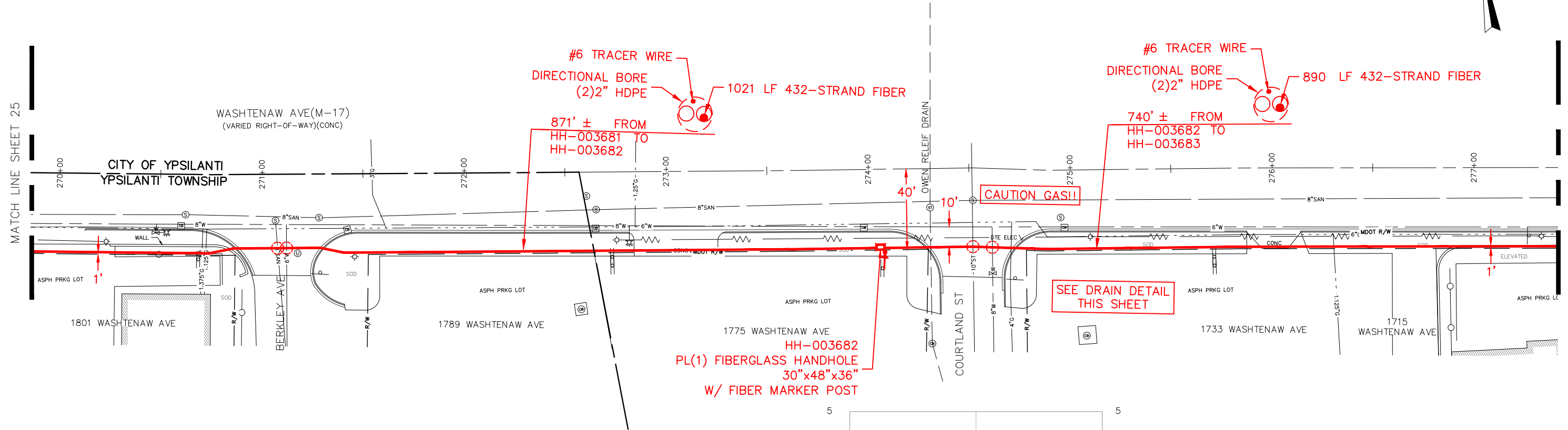

REVISION		
REV #	DATE	DESCRIPTION
01	05/30/23	ADDED DRAIN DETAIL SHT 15. CORRECTED DRAIN NAME SHT 26
02	06/22/23	ADD WTR DIM PER PITTSFIELD, CORRECTED 6\"/>



THE LOCATIONS OF EXISTING UNDERGROUND UTILITIES ARE SHOWN IN AN APPROXIMATE WAY ONLY AND HAVE NOT BEEN INDEPENDENTLY VERIFIED. THE CONTRACTOR SHALL DETERMINE THE EXACT LOCATION OF ALL EXISTING UTILITIES BEFORE COMMENCING WORK, AND AGREES TO BE FULLY RESPONSIBLE FOR ANY AND ALL DAMAGES WHICH MIGHT BE OCCASIONED BY THE CONTRACTOR'S FAILURE TO EXACTLY LOCATE AND PRESERVE ANY AND ALL UNDERGROUND UTILITIES.

METRO ENGINEERING SOLUTIONS
33900 SCHOOLCRAFT RD
LIVONIA, MICHIGAN 48150
PHONE: 734.483.1427 FAX: 734.483.3431
www.metroes.net

NORTH ROUTE - EAST OF U.S. 23	
MES JOB# 1043-22	DRAWN — KMM
PLOT SCALE = 1" = 50'	CHECKED - JB
PLAN DATE = 05/11/2023	

ANN ARBOR SPARK
CORRIDOR FIBER OPTIC BACKBONE PROJECT
ANN ARBOR
WASHTENAW COUNTY, MI

PERMITS REQUIRED:		
<input type="checkbox"/> CITY OF ANN ARBOR	<input checked="" type="checkbox"/> CITY OF YPSILANTI	<input type="checkbox"/> EGLE
<input checked="" type="checkbox"/> WASHTENAW COUNTY	<input checked="" type="checkbox"/> YPSILANTI TOWNSHIP	<input type="checkbox"/> RR
<input checked="" type="checkbox"/> WASHTENAW COUNTY DRAIN	<input checked="" type="checkbox"/> PITTSFIELD TOWNSHIP	<input checked="" type="checkbox"/> MDOT

SHEET INFORMATION	
TOTAL SHEETS	SHEET NO.
39	26

CITY OF YPSILANTI
SEC:05 T:03S R:07E

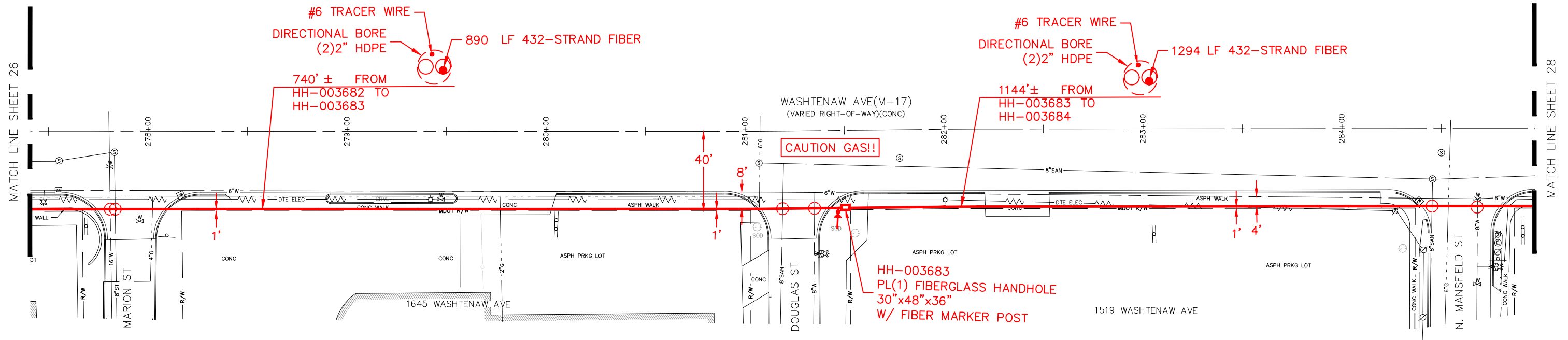
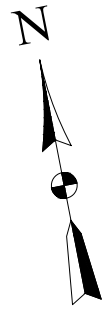

K:\2022\1043 JOB FOLDERS\1043-22-0327\DWG\1043-22-0327_DS.dwg; 5/30/2023 1:00 PM;



THE LOCATIONS OF EXISTING UNDERGROUND UTILITIES ARE SHOWN IN AN APPROXIMATE WAY ONLY AND HAVE NOT BEEN INDEPENDENTLY VERIFIED. THE CONTRACTOR SHALL DETERMINE THE EXACT LOCATION OF ALL EXISTING UTILITIES BEFORE COMMENCING WORK, AND AGREES TO BE FULLY RESPONSIBLE FOR ANY AND ALL DAMAGES WHICH MIGHT BE OCCASIONED BY THE CONTRACTOR'S FAILURE TO EXACTLY LOCATE AND PRESERVE ANY AND ALL UNDERGROUND UTILITIES.

METRO ENGINEERING SOLUTIONS
33900 SCHOOLCRAFT RD
LIVONIA, MICHIGAN 48150
PHONE: 734.483.1427 FAX: 734.483.3431
www.metroes.net

NORTH ROUTE - EAST OF U.S. 23	
MES JOB# 1043-22	DRAWN — KMM
PLOT SCALE = 1" = 50'	CHECKED - JB
PLAN DATE = 05/11/2023	

ANN ARBOR SPARK
CORRIDOR FIBER OPTIC BACKBONE PROJECT
ANN ARBOR
WASHTENAW COUNTY, MI

PERMITS REQUIRED:		
<input type="checkbox"/> CITY OF ANN ARBOR	<input checked="" type="checkbox"/> CITY OF YPSILANTI	<input type="checkbox"/> EGLE
<input checked="" type="checkbox"/> WASHTENAW COUNTY	<input checked="" type="checkbox"/> YPSILANTI TOWNSHIP	<input type="checkbox"/> RR
<input checked="" type="checkbox"/> WASHTENAW COUNTY DRAIN	<input checked="" type="checkbox"/> PITTSFIELD TOWNSHIP	<input checked="" type="checkbox"/> MDOT

SHEET INFORMATION	
TOTAL SHEETS	SHEET NO.
39	27

REVISION		
REV #	DATE	DESCRIPTION
01	05/30/23	ADDED DRAIN DETAIL SHT 15. CORRECTED DRAIN NAME SHT 26
02	06/22/23	ADD WTR DIM PER PITTSFIELD, CORRECTED 6" WTR SHT 18
03	06/30/23	ADD WTR & SAN SRV SHTS 10,17&18. DEPTH NOTE SHT 18
04	08/30/23	REV PER CITY OF YPSI COMMENTS. ADD SHTS 38 & 39

CITY OF YPSILANTI
SEC:05 T:03S R:07E

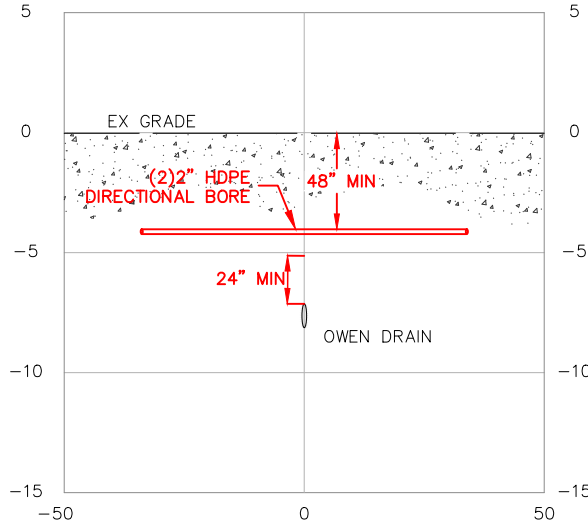
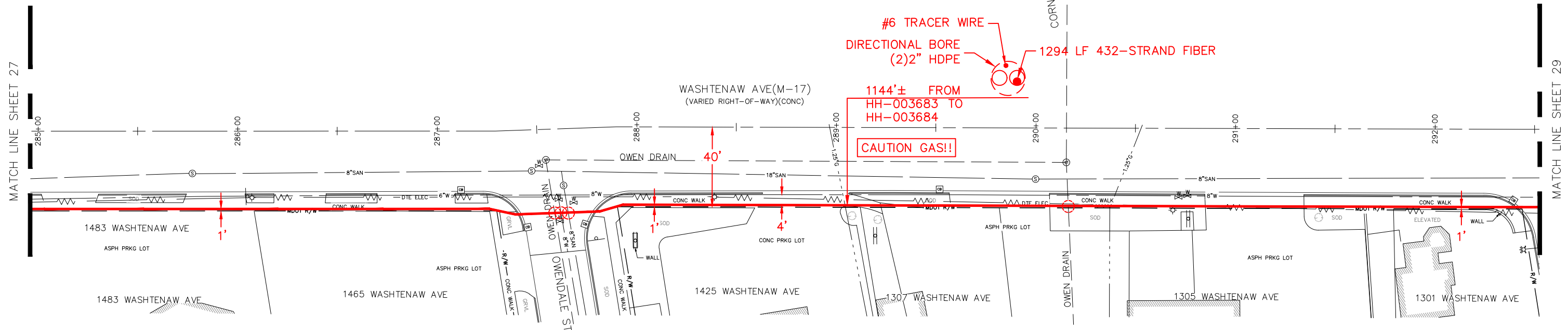
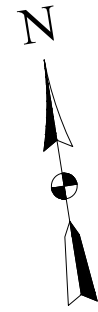

DRAIN CROSSING DETAIL
OWEN DRAIN
STA 287+57
NOT TO SCALE

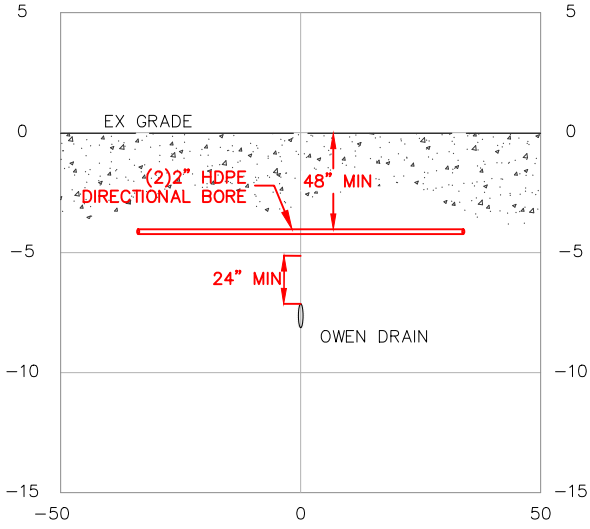

DRAIN CROSSING DETAIL
OWEN DRAIN
STA 290+15
NOT TO SCALE

REVISION		
REV #	DATE	DESCRIPTION
01	05/30/23	ADDED DRAIN DETAIL SHT 15. CORRECTED DRAIN NAME SHT 26
02	06/22/23	ADD WTR DIM PER PITTSFIELD, CORRECTED 6\"/>



THE LOCATIONS OF EXISTING UNDERGROUND UTILITIES ARE SHOWN IN AN APPROXIMATE WAY ONLY AND HAVE NOT BEEN INDEPENDENTLY VERIFIED. THE CONTRACTOR SHALL DETERMINE THE EXACT LOCATION OF ALL EXISTING UTILITIES BEFORE COMMENCING WORK, AND AGREES TO BE FULLY RESPONSIBLE FOR ANY AND ALL DAMAGES WHICH MIGHT BE OCCASIONED BY THE CONTRACTOR'S FAILURE TO EXACTLY LOCATE AND PRESERVE ANY AND ALL UNDERGROUND UTILITIES.

METRO ENGINEERING SOLUTIONS
33900 SCHOOLCRAFT RD
LIVONIA, MICHIGAN 48150
PHONE: 734.483.1427 FAX: 734.483.3431
www.metroes.net

NORTH ROUTE - EAST OF U.S. 23	
MES JOB# 1043-22	DRAWN - KMM
PLOT SCALE = 1" = 50'	CHECKED - JB
PLAN DATE = 05/11/2023	

ANN ARBOR SPARK
CORRIDOR FIBER OPTIC BACKBONE PROJECT
ANN ARBOR
WASHTENAW COUNTY, MI

PERMITS REQUIRED:		
<input type="checkbox"/> CITY OF ANN ARBOR	<input checked="" type="checkbox"/> CITY OF YPSILANTI	<input type="checkbox"/> EGLE
<input checked="" type="checkbox"/> WASHTENAW COUNTY	<input checked="" type="checkbox"/> YPSILANTI TOWNSHIP	<input type="checkbox"/> RR
<input checked="" type="checkbox"/> WASHTENAW COUNTY DRAIN	<input checked="" type="checkbox"/> PITTSFIELD TOWNSHIP	<input checked="" type="checkbox"/> MDOT

SHEET INFORMATION	
TOTAL SHEETS	SHEET NO.
39	28

K:\2022\1043 JOB FOLDERS\1043-22-0327\DWG\1043-22-0327_DS.dwg; 5/30/2023 1:00 PM;

CITY OF YPSILANTI
SEC:05 T:03S R:07E

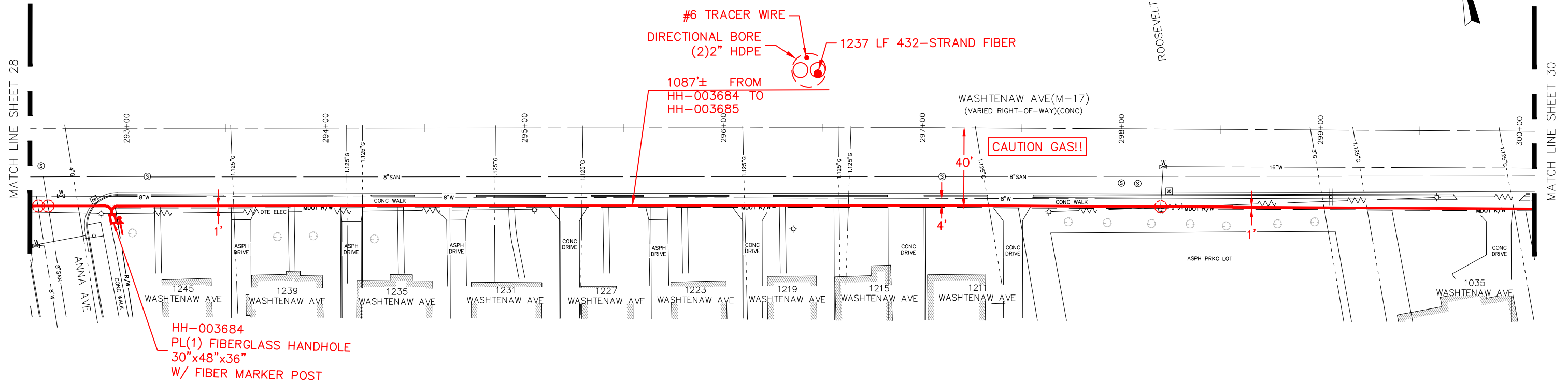
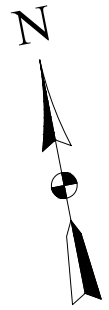

K:\2022\1043 JOB FOLDERS\1043-22-0327\DWG\1043-22-0327_DS.dwg; 5/30/2023 1:00 PM;



THE LOCATIONS OF EXISTING UNDERGROUND UTILITIES ARE SHOWN IN AN APPROXIMATE WAY ONLY AND HAVE NOT BEEN INDEPENDENTLY VERIFIED. THE CONTRACTOR SHALL DETERMINE THE EXACT LOCATION OF ALL EXISTING UTILITIES BEFORE COMMENCING WORK, AND AGREES TO BE FULLY RESPONSIBLE FOR ANY AND ALL DAMAGES WHICH MIGHT BE OCCASIONED BY THE CONTRACTOR'S FAILURE TO EXACTLY LOCATE AND PRESERVE ANY AND ALL UNDERGROUND UTILITIES.

REVISION		
REV #	DATE	DESCRIPTION
01	05/30/23	ADDED DRAIN DETAIL SHT 15. CORRECTED DRAIN NAME SHT 26
02	06/22/23	ADD WTR DIM PER PITTSFIELD, CORRECTED 6" WTR SHT 18
03	06/30/23	ADD WTR & SAN SRV SHTS 10,17&18. DEPTH NOTE SHT 18
04	08/30/23	REV PER CITY OF YPSI COMMENTS. ADD SHTS 38 & 39

METRO ENGINEERING SOLUTIONS
33900 SCHOOLCRAFT RD
LIVONIA, MICHIGAN 48150
PHONE: 734.483.1427 FAX: 734.483.3431
www.metroes.net

NORTH ROUTE - EAST OF U.S. 23	
MES JOB# 1043-22	DRAWN — KMM
PLOT SCALE = 1" = 50'	CHECKED - JB
PLAN DATE = 05/11/2023	

ANN ARBOR SPARK
CORRIDOR FIBER OPTIC BACKBONE PROJECT
ANN ARBOR
WASHTENAW COUNTY, MI

PERMITS REQUIRED:		
<input type="checkbox"/> CITY OF ANN ARBOR	<input checked="" type="checkbox"/> CITY OF YPSILANTI	<input type="checkbox"/> EGLE
<input checked="" type="checkbox"/> WASHTENAW COUNTY	<input checked="" type="checkbox"/> YPSILANTI TOWNSHIP	<input type="checkbox"/> RR
<input checked="" type="checkbox"/> WASHTENAW COUNTY DRAIN	<input checked="" type="checkbox"/> PITTSFIELD TOWNSHIP	<input checked="" type="checkbox"/> MDOT

SHEET INFORMATION	
TOTAL SHEETS	SHEET NO.
39	29

CITY OF YPSILANTI
SEC:05 T:03S R:07E

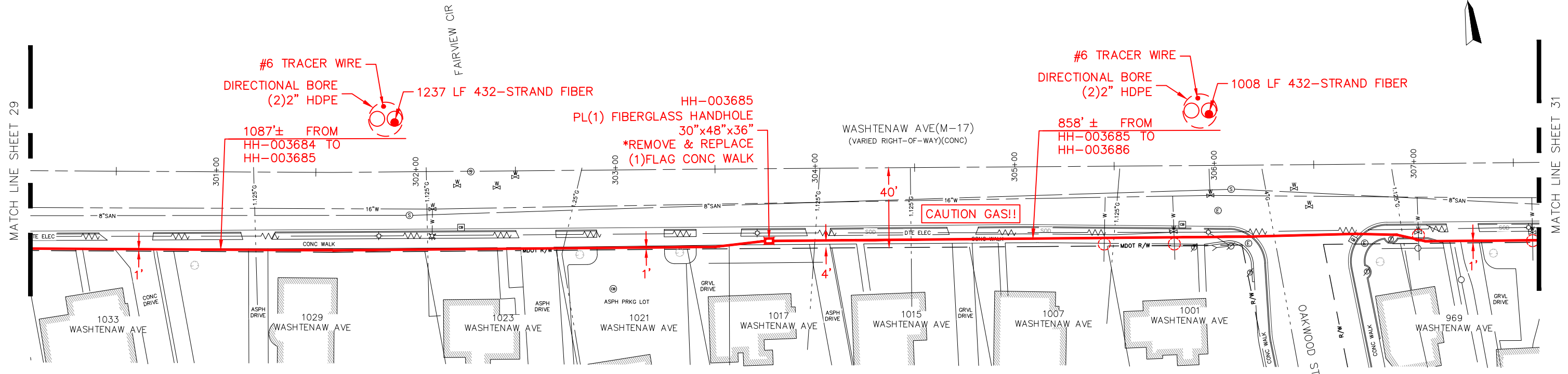
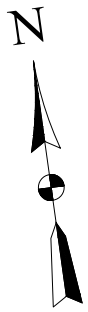

K:\2022\1043 JOB FOLDERS\1043-22-0327\DWG\1043-22-0327_DS.dwg; 5/30/2023 1:00 PM;



THE LOCATIONS OF EXISTING UNDERGROUND UTILITIES ARE SHOWN IN AN APPROXIMATE WAY ONLY AND HAVE NOT BEEN INDEPENDENTLY VERIFIED. THE CONTRACTOR SHALL DETERMINE THE EXACT LOCATION OF ALL EXISTING UTILITIES BEFORE COMMENCING WORK, AND AGREES TO BE FULLY RESPONSIBLE FOR ANY AND ALL DAMAGES WHICH MIGHT BE OCCASIONED BY THE CONTRACTOR'S FAILURE TO EXACTLY LOCATE AND PRESERVE ANY AND ALL UNDERGROUND UTILITIES.

METRO ENGINEERING SOLUTIONS
33900 SCHOOLCRAFT RD
LIVONIA, MICHIGAN 48150
PHONE: 734.483.1427 FAX: 734.483.3431
www.metroes.net

NORTH ROUTE - EAST OF U.S. 23	
MES JOB# 1043-22	DRAWN — KMM
PLOT SCALE = 1" = 50'	CHECKED - JB
PLAN DATE = 05/11/2023	

ANN ARBOR SPARK
CORRIDOR FIBER OPTIC BACKBONE PROJECT
ANN ARBOR
WASHTENAW COUNTY, MI

PERMITS REQUIRED:		
<input type="checkbox"/> CITY OF ANN ARBOR	<input checked="" type="checkbox"/> CITY OF YPSILANTI	<input type="checkbox"/> EGLE
<input checked="" type="checkbox"/> WASHTENAW COUNTY	<input checked="" type="checkbox"/> YPSILANTI TOWNSHIP	<input type="checkbox"/> RR
<input checked="" type="checkbox"/> WASHTENAW COUNTY DRAIN	<input checked="" type="checkbox"/> PITTSFIELD TOWNSHIP	<input checked="" type="checkbox"/> MDOT

SHEET INFORMATION	
TOTAL SHEETS	SHEET NO.
39	30

REVISION		
REV #	DATE	DESCRIPTION
01	05/30/23	ADDED DRAIN DETAIL SHT 15. CORRECTED DRAIN NAME SHT 26
02	06/22/23	ADD WTR DIM PER PITTSFIELD, CORRECTED 6" WTR SHT 18
03	06/30/23	ADD WTR & SAN SRV SHTS 10,17&18. DEPTH NOTE SHT 18
04	08/30/23	REV PER CITY OF YPSI COMMENTS. ADD SHTS 38 & 39

CITY OF YPSILANTI
SEC:05 T:03S R:07E

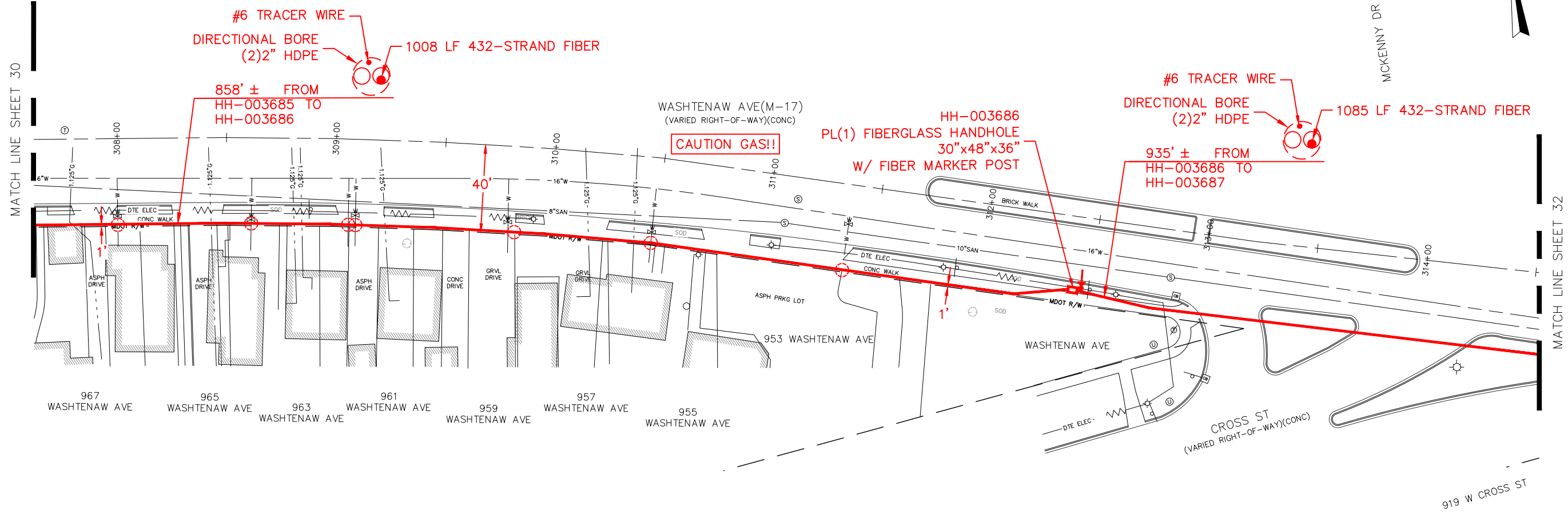
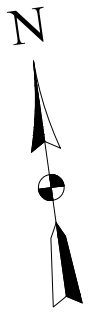

K:\2022\1043 JOB FOLDERS\1043-22-0327\DWG\1043-22-0327_DS.dwg; 5/30/2023 1:00 PM;



THE LOCATIONS OF EXISTING UNDERGROUND UTILITIES ARE SHOWN IN AN APPROXIMATE WAY ONLY AND HAVE NOT BEEN INDEPENDENTLY VERIFIED. THE CONTRACTOR SHALL DETERMINE THE EXACT LOCATION OF ALL EXISTING UTILITIES BEFORE COMMENCING WORK, AND AGREES TO BE FULLY RESPONSIBLE FOR ANY AND ALL DAMAGES WHICH MIGHT BE OCCASIONED BY THE CONTRACTOR'S FAILURE TO EXACTLY LOCATE AND PRESERVE ANY AND ALL UNDERGROUND UTILITIES.

METRO ENGINEERING SOLUTIONS
33900 SCHOOLCRAFT RD
LIVONIA, MICHIGAN 48150
PHONE: 734.483.1427 FAX: 734.483.3431
www.metroes.net

NORTH ROUTE - EAST OF U.S. 23	
MES JOB# 1043-22	DRAWN — KMM
PLOT SCALE = 1" = 50'	CHECKED - JB
PLAN DATE = 05/11/2023	

ANN ARBOR SPARK
CORRIDOR FIBER OPTIC BACKBONE PROJECT
ANN ARBOR
WASHTENAW COUNTY, MI

PERMITS REQUIRED:		
<input type="checkbox"/> CITY OF ANN ARBOR	<input checked="" type="checkbox"/> CITY OF YPSILANTI	<input type="checkbox"/> EGLE
<input checked="" type="checkbox"/> WASHTENAW COUNTY	<input checked="" type="checkbox"/> YPSILANTI TOWNSHIP	<input type="checkbox"/> RR
<input checked="" type="checkbox"/> WASHTENAW COUNTY DRAIN	<input checked="" type="checkbox"/> PITTSFIELD TOWNSHIP	<input checked="" type="checkbox"/> MDOT

SHEET INFORMATION	
TOTAL SHEETS	SHEET NO.
39	31

REVISION		
REV #	DATE	DESCRIPTION
01	05/30/23	ADDED DRAIN DETAIL SHT 15. CORRECTED DRAIN NAME SHT 26
02	06/22/23	ADD WTR DIM PER PITTSFIELD, CORRECTED 6" WTR SHT 18
03	06/30/23	ADD WTR & SAN SRV SHTS 10,17&18. DEPTH NOTE SHT 18
04	08/30/23	REV PER CITY OF YPSI COMMENTS. ADD SHTS 38 & 39

CITY OF YPSILANTI
SEC:05 T:02S R:07E

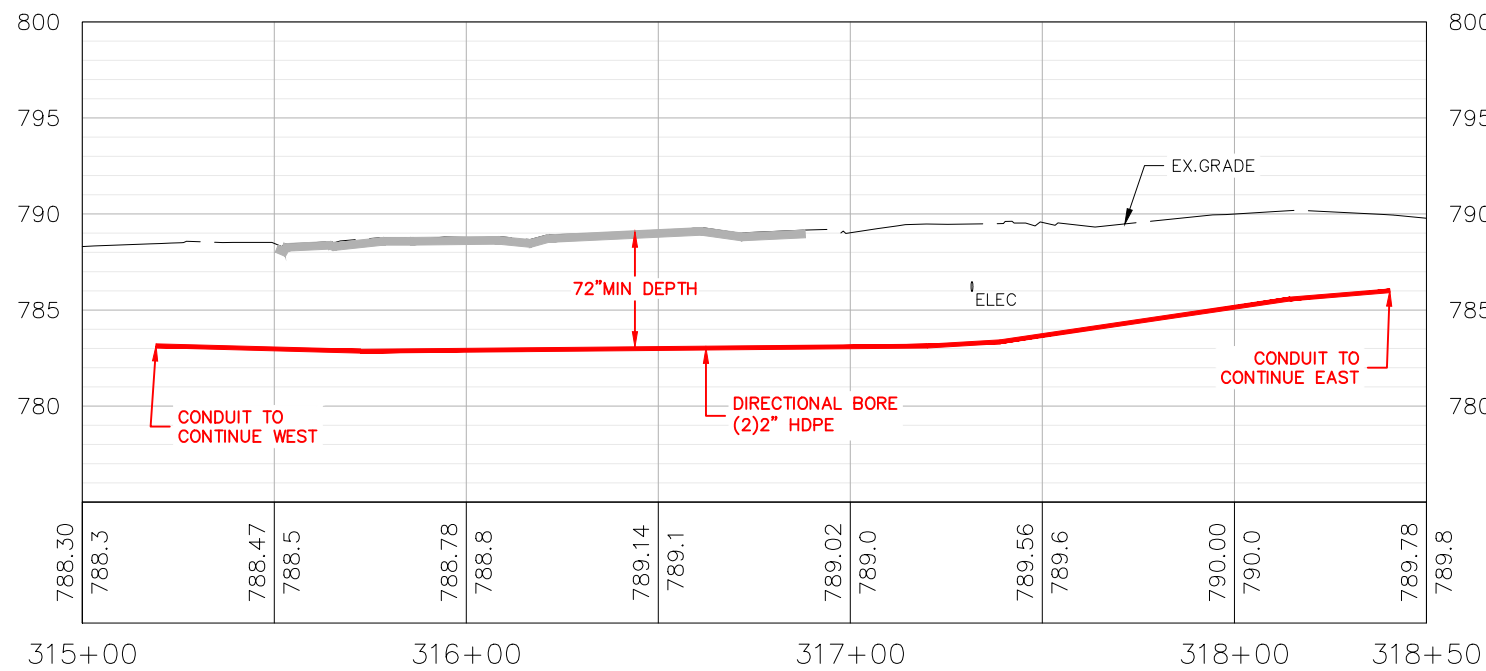
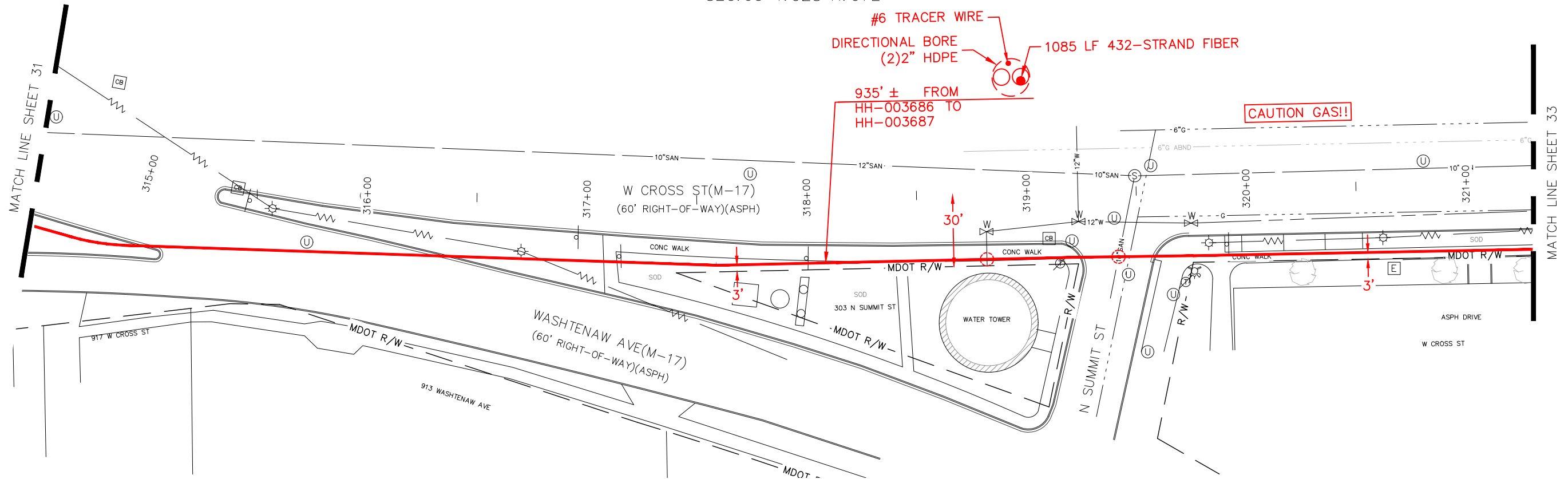
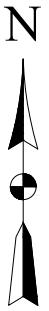

WASHTENAW AVE
1"=50' HORIZONTAL
1"=10' VERTICAL

REVISION		
REV #	DATE	DESCRIPTION
01	05/30/23	ADDED DRAIN DETAIL SHT 15. CORRECTED DRAIN NAME SHT 26
02	06/22/23	ADD WTR DIM PER PITTSFIELD, CORRECTED 6" WTR SHT 18
03	06/30/23	ADD WTR & SAN SRV SHTS 10,17&18. DEPTH NOTE SHT 18
04	08/30/23	REV PER CITY OF YPSI COMMENTS. ADD SHTS 38 & 39



THE LOCATIONS OF EXISTING UNDERGROUND UTILITIES ARE SHOWN IN AN APPROXIMATE WAY ONLY AND HAVE NOT BEEN INDEPENDENTLY VERIFIED. THE CONTRACTOR SHALL DETERMINE THE EXACT LOCATION OF ALL EXISTING UTILITIES BEFORE COMMENCING WORK, AND AGREES TO BE FULLY RESPONSIBLE FOR ANY AND ALL DAMAGES WHICH MIGHT BE OCCASIONED BY THE CONTRACTOR'S FAILURE TO EXACTLY LOCATE AND PRESERVE ANY AND ALL UNDERGROUND UTILITIES.



33900 SCHOOLCRAFT RD
LIVONIA, MICHIGAN 48150
PHONE: 734.483.1427 FAX: 734.483.3431
www.metroes.net

NORTH ROUTE - EAST OF U.S. 23	
MES JOB# 1043-22	DRAWN - KMM
PLOT SCALE = 1" = 50'	CHECKED - JB
PLAN DATE = 05/11/2023	

ANN ARBOR SPARK
CORRIDOR FIBER OPTIC BACKBONE PROJECT
ANN ARBOR
WASHTENAW COUNTY, MI

PERMITS REQUIRED:

<input type="checkbox"/> CITY OF ANN ARBOR	<input checked="" type="checkbox"/> CITY OF YPSILANTI	<input type="checkbox"/> EGLE
<input checked="" type="checkbox"/> WASHTENAW COUNTY	<input checked="" type="checkbox"/> YPSILANTI TOWNSHIP	<input type="checkbox"/> RR
<input checked="" type="checkbox"/> WASHTENAW COUNTY DRAIN	<input checked="" type="checkbox"/> PITTSFIELD TOWNSHIP	<input checked="" type="checkbox"/> MDOT

SHEET INFORMATION

TOTAL SHEETS	SHEET NO.
39	32

CITY OF YPSILANTI
SEC:05 T:02S R:07E

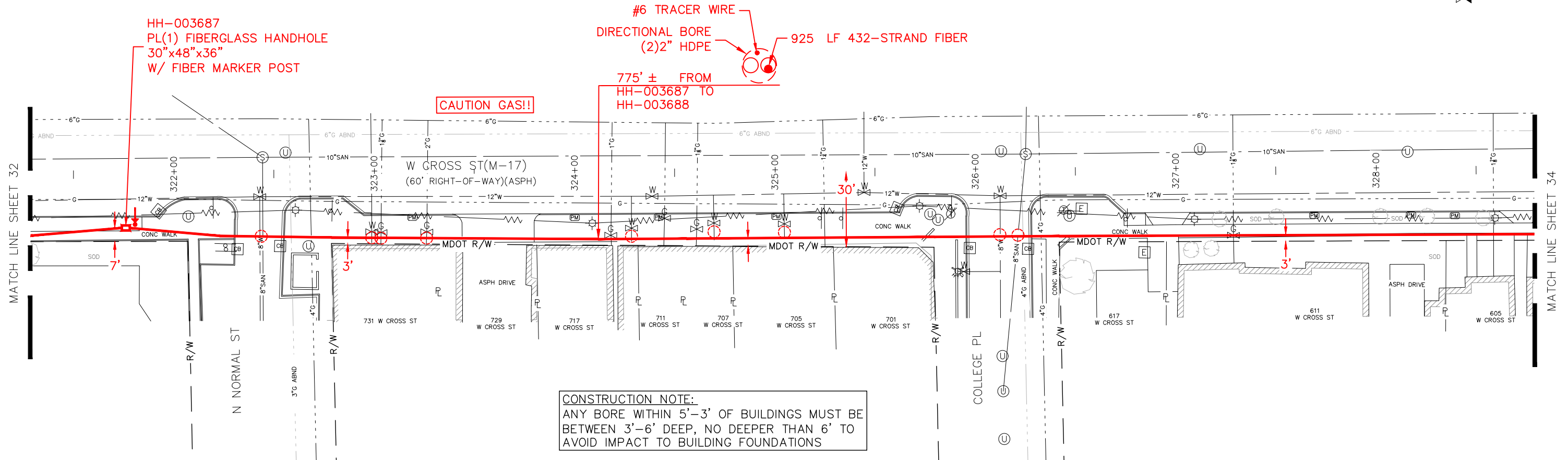
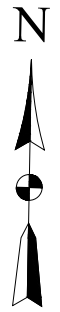

CONSTRUCTION NOTE:
ANY BORE WITHIN 5'-3' OF BUILDINGS MUST BE BETWEEN 3'-6' DEEP, NO DEEPER THAN 6' TO AVOID IMPACT TO BUILDING FOUNDATIONS

K:\2022\1043 JOB FOLDERS\1043-22-0328\DWG\1043-22-0328_DS.dwg; 8/30/2023 1:10 PM;



THE LOCATIONS OF EXISTING UNDERGROUND UTILITIES ARE SHOWN IN AN APPROXIMATE WAY ONLY AND HAVE NOT BEEN INDEPENDENTLY VERIFIED. THE CONTRACTOR SHALL DETERMINE THE EXACT LOCATION OF ALL EXISTING UTILITIES BEFORE COMMENCING WORK, AND AGREES TO BE FULLY RESPONSIBLE FOR ANY AND ALL DAMAGES WHICH MIGHT BE OCCASIONED BY THE CONTRACTOR'S FAILURE TO EXACTLY LOCATE AND PRESERVE ANY AND ALL UNDERGROUND UTILITIES.

METRO ENGINEERING SOLUTIONS
33900 SCHOOLCRAFT RD
LIVONIA, MICHIGAN 48150
PHONE: 734.483.1427 FAX: 734.483.3431
www.metroes.net

NORTH ROUTE - EAST OF U.S. 23	
MES JOB# 1043-22	DRAWN — KMM
PLOT SCALE = 1" = 50'	CHECKED - JB
PLAN DATE = 05/11/2023	

ANN ARBOR SPARK
CORRIDOR FIBER OPTIC BACKBONE PROJECT
ANN ARBOR
WASHTENAW COUNTY, MI

PERMITS REQUIRED:

<input type="checkbox"/> CITY OF ANN ARBOR	<input checked="" type="checkbox"/> CITY OF YPSILANTI	<input type="checkbox"/> EGLE
<input checked="" type="checkbox"/> WASHTENAW COUNTY	<input checked="" type="checkbox"/> YPSILANTI TOWNSHIP	<input type="checkbox"/> RR
<input checked="" type="checkbox"/> WASHTENAW COUNTY DRAIN	<input checked="" type="checkbox"/> PITTSFIELD TOWNSHIP	<input checked="" type="checkbox"/> MDOT

SHEET INFORMATION	
TOTAL SHEETS	SHEET NO.
39	33

REVISION		
REV #	DATE	DESCRIPTION
01	05/30/23	ADDED DRAIN DETAIL SHT 15. CORRECTED DRAIN NAME SHT 26
02	06/22/23	ADD WTR DIM PER PITTSFIELD, CORRECTED 6" WTR SHT 18
03	06/30/23	ADD WTR & SAN SRV SHTS 10,17&18. DEPTH NOTE SHT 18
04	08/30/23	REV PER CITY OF YPSI COMMENTS. ADD SHTS 38 & 39

CITY OF YPSILANTI
SEC:09 T:02S R:07E

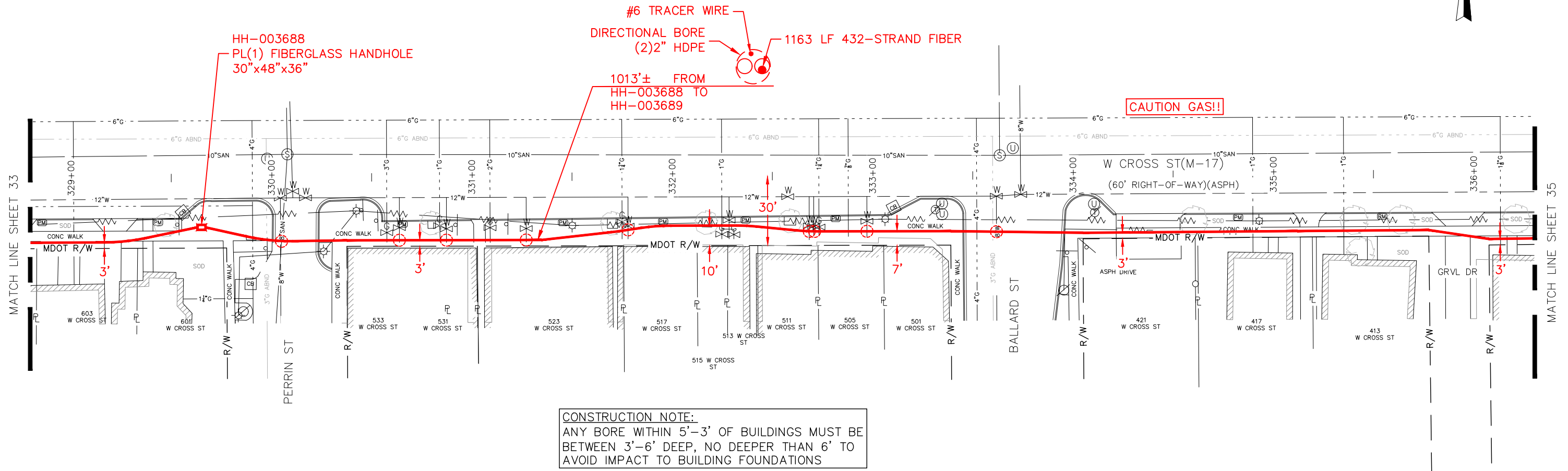
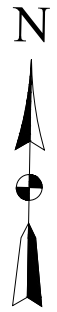

CONSTRUCTION NOTE:
ANY BORE WITHIN 5'-3' OF BUILDINGS MUST BE BETWEEN 3'-6' DEEP, NO DEEPER THAN 6' TO AVOID IMPACT TO BUILDING FOUNDATIONS

K:\2022\1043 JOB FOLDERS\1043-22-0328\DWG\1043-22-0328_DS.dwg; 8/30/2023 1:10 PM;



THE LOCATIONS OF EXISTING UNDERGROUND UTILITIES ARE SHOWN IN AN APPROXIMATE WAY ONLY AND HAVE NOT BEEN INDEPENDENTLY VERIFIED. THE CONTRACTOR SHALL DETERMINE THE EXACT LOCATION OF ALL EXISTING UTILITIES BEFORE COMMENCING WORK, AND AGREES TO BE FULLY RESPONSIBLE FOR ANY AND ALL DAMAGES WHICH MIGHT BE OCCASIONED BY THE CONTRACTOR'S FAILURE TO EXACTLY LOCATE AND PRESERVE ANY AND ALL UNDERGROUND UTILITIES.

METRO ENGINEERING SOLUTIONS
33900 SCHOOLCRAFT RD
LIVONIA, MICHIGAN 48150
PHONE: 734.483.1427 FAX: 734.483.3431
www.metroes.net

NORTH ROUTE - EAST OF U.S. 23	
MES JOB# 1043-22	DRAWN — KMM
PLOT SCALE = 1" = 50'	CHECKED - JB
PLAN DATE = 05/11/2023	

ANN ARBOR SPARK
CORRIDOR FIBER OPTIC BACKBONE PROJECT
ANN ARBOR
WASHTENAW COUNTY, MI

PERMITS REQUIRED:		
<input type="checkbox"/> CITY OF ANN ARBOR	<input checked="" type="checkbox"/> CITY OF YPSILANTI	<input type="checkbox"/> EGLE
<input checked="" type="checkbox"/> WASHTENAW COUNTY	<input checked="" type="checkbox"/> YPSILANTI TOWNSHIP	<input type="checkbox"/> RR
<input checked="" type="checkbox"/> WASHTENAW COUNTY DRAIN	<input checked="" type="checkbox"/> PITTSFIELD TOWNSHIP	<input checked="" type="checkbox"/> MDOT

SHEET INFORMATION	
TOTAL SHEETS	SHEET NO.
39	34

REVISION		
REV #	DATE	DESCRIPTION
01	05/30/23	ADDED DRAIN DETAIL SHT 15. CORRECTED DRAIN NAME SHT 26
02	06/22/23	ADD WTR DIM PER PITTSFIELD, CORRECTED 6" WTR SHT 18
03	06/30/23	ADD WTR & SAN SRV SHTS 10,17&18. DEPTH NOTE SHT 18
04	08/30/23	REV PER CITY OF YPSI COMMENTS. ADD SHTS 38 & 39

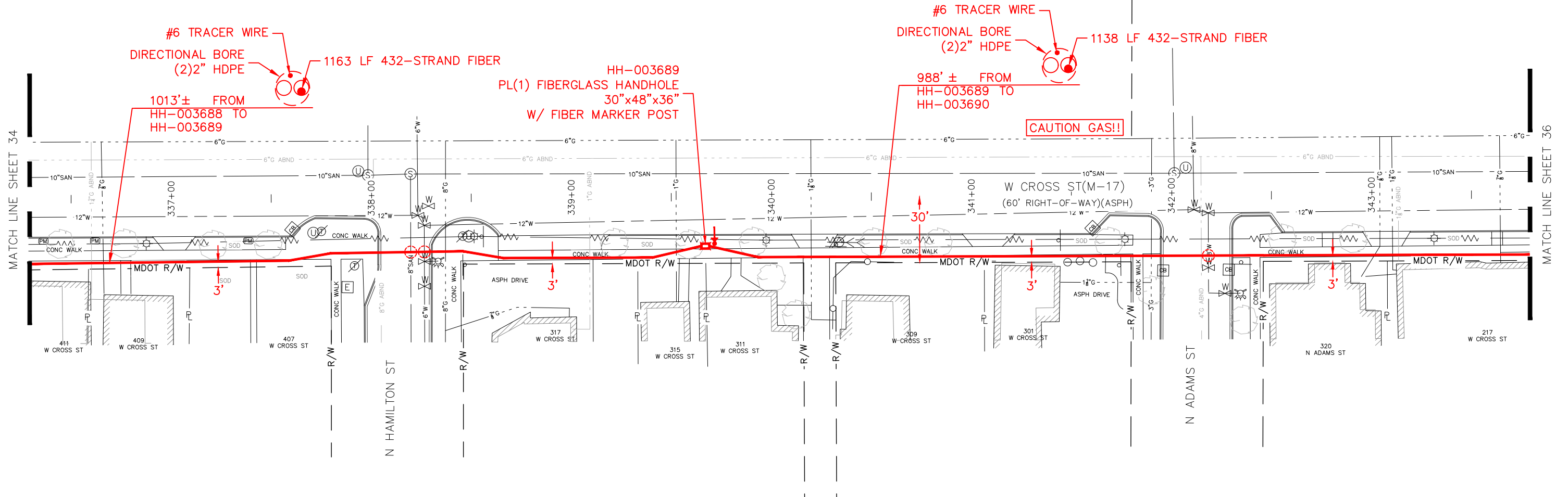
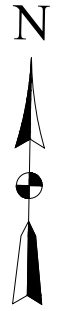

CONSTRUCTION NOTE:
ANY BORE WITHIN 5'-3' OF BUILDINGS MUST BE BETWEEN 3'-6' DEEP, NO DEEPER THAN 6' TO AVOID IMPACT TO BUILDING FOUNDATIONS

K:\2022\1043 JOB FOLDERS\1043-22-0328\DWG\1043-22-0328_DS.dwg; 8/30/2023 1:10 PM;



THE LOCATIONS OF EXISTING UNDERGROUND UTILITIES ARE SHOWN IN AN APPROXIMATE WAY ONLY AND HAVE NOT BEEN INDEPENDENTLY VERIFIED. THE CONTRACTOR SHALL DETERMINE THE EXACT LOCATION OF ALL EXISTING UTILITIES BEFORE COMMENCING WORK, AND AGREES TO BE FULLY RESPONSIBLE FOR ANY AND ALL DAMAGES WHICH MIGHT BE OCCASIONED BY THE CONTRACTOR'S FAILURE TO EXACTLY LOCATE AND PRESERVE ANY AND ALL UNDERGROUND UTILITIES.

REVISION		
REV #	DATE	DESCRIPTION
01	05/30/23	ADDED DRAIN DETAIL SHT 15. CORRECTED DRAIN NAME SHT 26
02	06/22/23	ADD WTR DIM PER PITTSFIELD, CORRECTED 6" WTR SHT 18
03	06/30/23	ADD WTR & SAN SRV SHTS 10,17&18. DEPTH NOTE SHT 18
04	08/30/23	REV PER CITY OF YPSI COMMENTS. ADD SHTS 38 & 39

METRO ENGINEERING SOLUTIONS
33900 SCHOOLCRAFT RD
LIVONIA, MICHIGAN 48150
PHONE: 734.483.1427 FAX: 734.483.3431
www.metroes.net

NORTH ROUTE - EAST OF U.S. 23	
MES JOB# 1043-22	DRAWN — KMM
PLOT SCALE = 1" = 50'	CHECKED — JB
PLAN DATE = 05/11/2023	

ANN ARBOR SPARK
CORRIDOR FIBER OPTIC BACKBONE PROJECT
ANN ARBOR
WASHTENAW COUNTY, MI

PERMITS REQUIRED:		
<input type="checkbox"/> CITY OF ANN ARBOR	<input checked="" type="checkbox"/> CITY OF YPSILANTI	<input type="checkbox"/> EGLE
<input checked="" type="checkbox"/> WASHTENAW COUNTY	<input checked="" type="checkbox"/> YPSILANTI TOWNSHIP	<input type="checkbox"/> RR
<input checked="" type="checkbox"/> WASHTENAW COUNTY DRAIN	<input checked="" type="checkbox"/> PITTSFIELD TOWNSHIP	<input checked="" type="checkbox"/> MDOT

SHEET INFORMATION	
TOTAL SHEETS	SHEET NO.
39	35

CITY OF YPSILANTI
SEC:09 T:02S R:07E

CAUTION GAS!!

MATCH LINE SHEET 35

1138 LF 432-STRAND FIBER
#6 TRACER WIRE
DIRECTIONAL BORE
(2)2" HDPE
988' ± FROM
HH-003689 TO
HH-003690

CONSTRUCTION NOTE:
ANY BORE WITHIN 5'-3' OF BUILDINGS MUST BE BETWEEN 3'-6' DEEP, NO DEEPER THAN 6' TO AVOID IMPACT TO BUILDING FOUNDATIONS

HH-003690
PL(1) FIBERGLASS HANDHOLE
30"x48"x36"
W/ FIBER MARKER POST

ROAD CROSSING

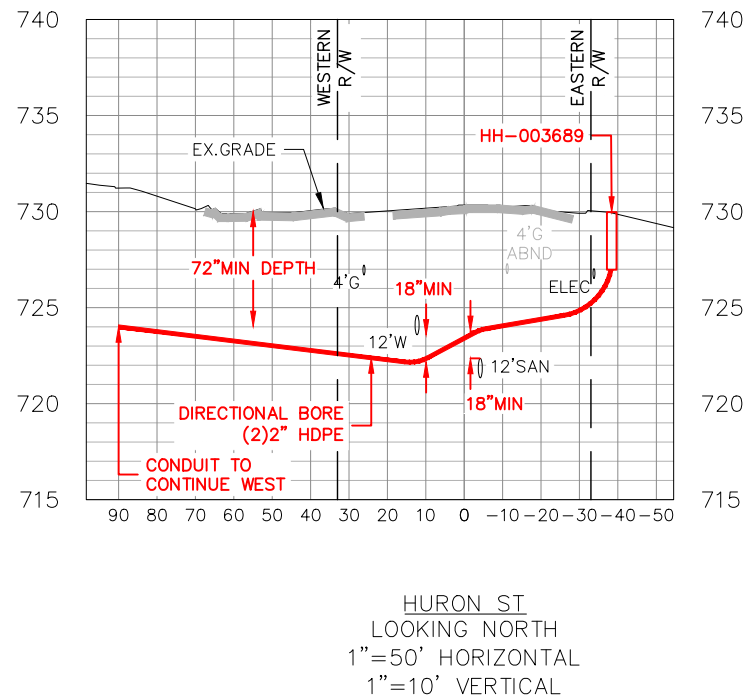

855 LF 432-STRAND FIBER
#6 TRACER WIRE
DIRECTIONAL BORE
(2)2" HDPE
705' ± FROM
HH-003690 TO
HH-003691

CAUTION GAS!!

MATCH LINE SHEET 37

REV #	DATE	REVISION DESCRIPTION
01	05/30/23	ADDED DRAIN DETAIL SHT 15. CORRECTED DRAIN NAME SHT 26
02	06/22/23	ADD WTR DIM PER PITTSFIELD, CORRECTED 6" WTR SHT 18
03	06/30/23	ADD WTR & SAN SRV SHTS 10,17&18. DEPTH NOTE SHT 18
04	08/30/23	REV PER CITY OF YPSI COMMENTS. ADD SHTS 38 & 39



Know what's below.
Call before you dig.

THE LOCATIONS OF EXISTING UNDERGROUND UTILITIES ARE SHOWN IN AN APPROXIMATE WAY ONLY AND HAVE NOT BEEN INDEPENDENTLY VERIFIED. THE CONTRACTOR SHALL DETERMINE THE EXACT LOCATION OF ALL EXISTING UTILITIES BEFORE COMMENCING WORK, AND AGREES TO BE FULLY RESPONSIBLE FOR ANY AND ALL DAMAGES WHICH MIGHT BE OCCASIONED BY THE CONTRACTOR'S FAILURE TO EXACTLY LOCATE AND PRESERVE ANY AND ALL UNDERGROUND UTILITIES.

METRO ENGINEERING SOLUTIONS

33900 SCHOOLCRAFT RD
LIVONIA, MICHIGAN 48150
PHONE: 734.483.1427 FAX: 734.483.3431
www.metroes.net

NORTH ROUTE - EAST OF U.S. 23	
MES JOB#	1043-22
DRAWN	KMM
PLOT SCALE	1" = 50'
CHECKED	JB
PLAN DATE	05/11/2023

ANN ARBOR SPARK
CORRIDOR FIBER OPTIC BACKBONE PROJECT
ANN ARBOR
WASHTENAW COUNTY, MI

PERMITS REQUIRED:

<input type="checkbox"/> CITY OF ANN ARBOR	<input checked="" type="checkbox"/> CITY OF YPSILANTI	<input type="checkbox"/> EGLE
<input checked="" type="checkbox"/> WASHTENAW COUNTY	<input checked="" type="checkbox"/> YPSILANTI TOWNSHIP	<input type="checkbox"/> RR
<input checked="" type="checkbox"/> WASHTENAW COUNTY DRAIN	<input checked="" type="checkbox"/> PITTSFIELD TOWNSHIP	<input checked="" type="checkbox"/> MDOT

SHEET INFORMATION

TOTAL SHEETS	SHEET NO.
39	36

CITY OF YPSILANTI
 SEC:09 T:02S R:07E
 MATCH LINE SHEET 36

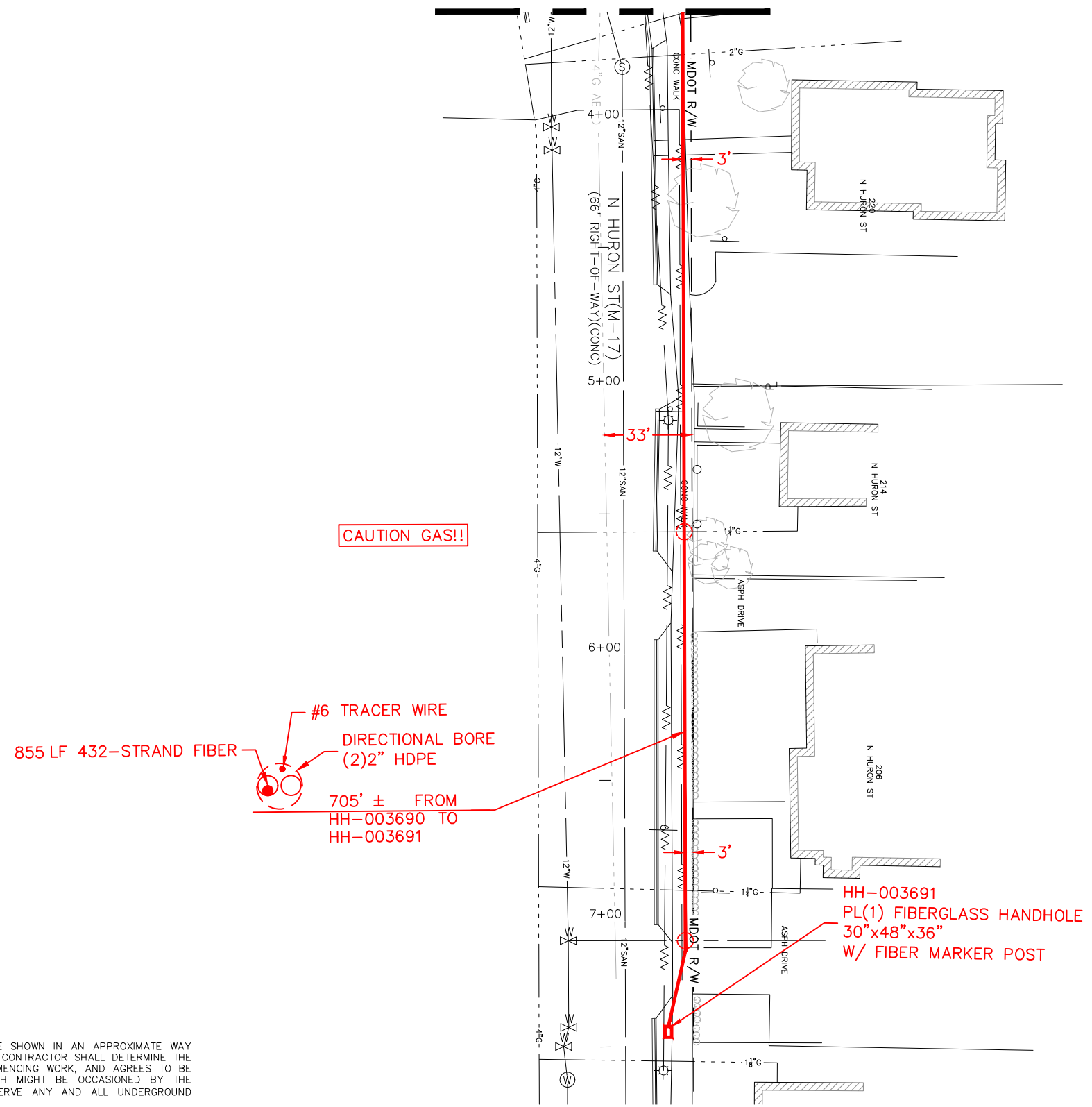

K:\2022\1043 JOB FOLDERS\1043-22-0328\DWG\1043-22-0328_DS.dwg; 8/30/2023 1:10 PM;



THE LOCATIONS OF EXISTING UNDERGROUND UTILITIES ARE SHOWN IN AN APPROXIMATE WAY ONLY AND HAVE NOT BEEN INDEPENDENTLY VERIFIED. THE CONTRACTOR SHALL DETERMINE THE EXACT LOCATION OF ALL EXISTING UTILITIES BEFORE COMMENCING WORK, AND AGREES TO BE FULLY RESPONSIBLE FOR ANY AND ALL DAMAGES WHICH MIGHT BE OCCASIONED BY THE CONTRACTOR'S FAILURE TO EXACTLY LOCATE AND PRESERVE ANY AND ALL UNDERGROUND UTILITIES.

METRO ENGINEERING SOLUTIONS
 33900 SCHOOLCRAFT RD
 LIVONIA, MICHIGAN 48150
 PHONE: 734.483.1427 FAX: 734.483.3431
 www.metroes.net

NORTH ROUTE - EAST OF U.S. 23	
MES JOB# 1043-22	DRAWN — KMM
PLOT SCALE = 1" = 50'	CHECKED - JB
PLAN DATE = 05/11/2023	

ANN ARBOR SPARK
 CORRIDOR FIBER OPTIC BACKBONE PROJECT
 ANN ARBOR
 WASHTENAW COUNTY, MI

PERMITS REQUIRED:		
<input type="checkbox"/> CITY OF ANN ARBOR	<input checked="" type="checkbox"/> CITY OF YPSILANTI	<input type="checkbox"/> EGLE
<input checked="" type="checkbox"/> WASHTENAW COUNTY	<input checked="" type="checkbox"/> YPSILANTI TOWNSHIP	<input type="checkbox"/> RR
<input checked="" type="checkbox"/> WASHTENAW COUNTY DRAIN	<input checked="" type="checkbox"/> PITTSFIELD TOWNSHIP	<input checked="" type="checkbox"/> MDOT

SHEET INFORMATION	
TOTAL SHEETS	SHEET NO.
39	37

REVISION		
REV #	DATE	DESCRIPTION
01	05/30/23	ADDED DRAIN DETAIL SHT 15. CORRECTED DRAIN NAME SHT 26
02	06/22/23	ADD WTR DIM PER PITTSFIELD, CORRECTED 6" WTR SHT 18
03	06/30/23	ADD WTR & SAN SRV SHTS 10,17&18. DEPTH NOTE SHT 18
04	08/30/23	REV PER CITY OF YPSI COMMENTS. ADD SHTS 38 & 39

PEDESTRIAN DETOUR – TYPICAL

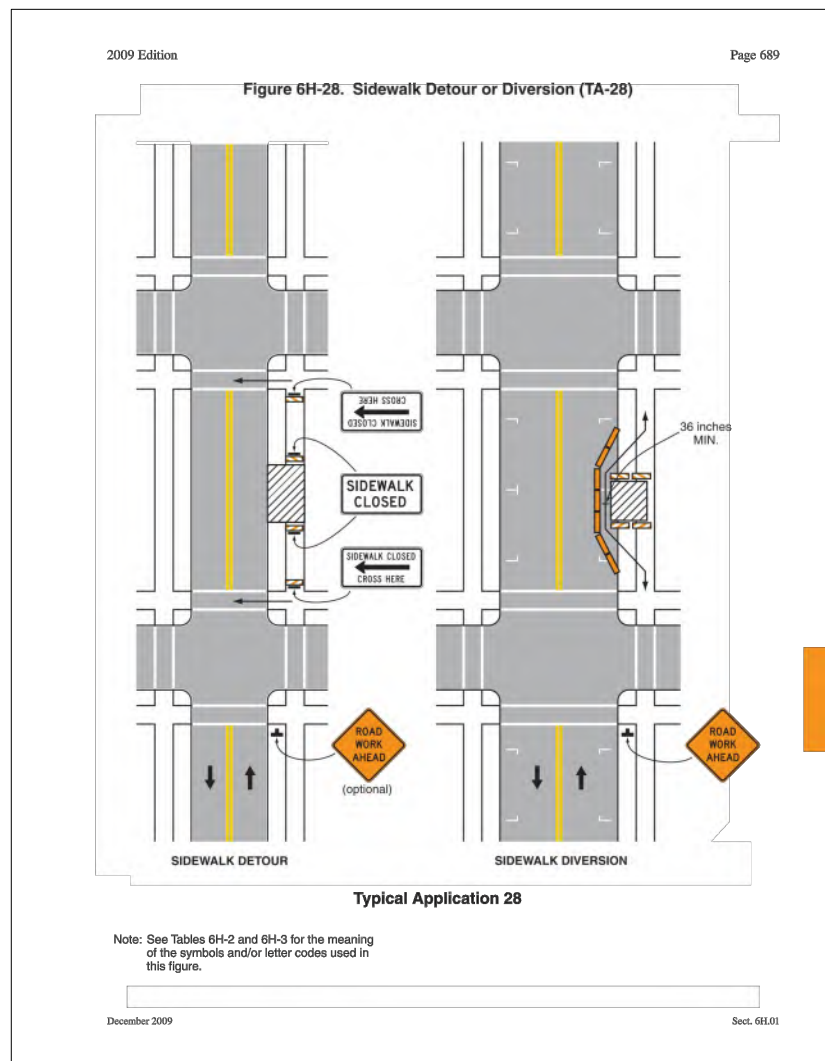

Page 690
2009 Edition

**Notes for Figure 6H-29—Typical Application 29
Crosswalk Closures and Pedestrian Detours**

Standard:

- When crosswalks or other pedestrian facilities are closed or relocated, temporary facilities shall be detectable and shall include accessibility features consistent with the features present in the existing pedestrian facility.
- Curb parking shall be prohibited for at least 50 feet in advance of the midblock crosswalk.

Guidance:

- Audible information devices should be considered where midblock closings and changed crosswalk areas cause inadequate communication to be provided to pedestrians who have visual disabilities.
- Pedestrian traffic signal displays controlling closed crosswalks should be covered or deactivated.

Option:

- Street lighting may be considered.
- Only the TTC devices related to pedestrians are shown. Other devices, such as lane closure signing or ROAD NARROWS signs, may be used to control vehicular traffic.
- For nighttime closures, Type A Flashing warning lights may be used on barricades supporting signs and closing sidewalks.
- Type C Steady-Burn or Type D 360-degree Steady-Burn warning lights may be used on channelizing devices separating the work space from vehicular traffic.
- In order to maintain the systematic use of the fluorescent yellow-green background for pedestrian, bicycle, and school warning signs in a jurisdiction, the fluorescent yellow-green background for pedestrian, bicycle, and school warning signs may be used in TTC zones.

Sect. 6H.01
December 2009

K:\2022\1043 JOB FOLDERS\1043-22-0328\DWG\1043-22-0328_DS.dwg; 8/30/2023 1:10 PM;



THE LOCATIONS OF EXISTING UNDERGROUND UTILITIES ARE SHOWN IN AN APPROXIMATE WAY ONLY AND HAVE NOT BEEN INDEPENDENTLY VERIFIED. THE CONTRACTOR SHALL DETERMINE THE EXACT LOCATION OF ALL EXISTING UTILITIES BEFORE COMMENCING WORK, AND AGREES TO BE FULLY RESPONSIBLE FOR ANY AND ALL DAMAGES WHICH MIGHT BE OCCASIONED BY THE CONTRACTOR'S FAILURE TO EXACTLY LOCATE AND PRESERVE ANY AND ALL UNDERGROUND UTILITIES.

METRO ENGINEERING SOLUTIONS
 33900 SCHOOLCRAFT RD
 LIVONIA, MICHIGAN 48150
 PHONE: 734.483.1427 FAX: 734.483.3431
 www.metroes.net

NORTH ROUTE – EAST OF U.S. 23	
MES JOB# 1043-22	DRAWN — KMM
PLOT SCALE = 1" = 50'	CHECKED — JB
PLAN DATE = 05/11/2023	

ANN ARBOR SPARK
 CORRIDOR FIBER OPTIC BACKBONE PROJECT
 ANN ARBOR
 WASHTENAW COUNTY, MI

PERMITS REQUIRED:		
<input type="checkbox"/> CITY OF ANN ARBOR	<input checked="" type="checkbox"/> CITY OF YPSILANTI	<input type="checkbox"/> EGLE
<input checked="" type="checkbox"/> WASHTENAW COUNTY	<input checked="" type="checkbox"/> YPSILANTI TOWNSHIP	<input type="checkbox"/> RR
<input checked="" type="checkbox"/> WASHTENAW COUNTY DRAIN	<input checked="" type="checkbox"/> PITTSFIELD TOWNSHIP	<input checked="" type="checkbox"/> MDOT

SHEET INFORMATION	
TOTAL SHEETS	SHEET NO.
39	38

REVISION		
REV #	DATE	DESCRIPTION
01	05/30/23	ADDED DRAIN DETAIL SHT 15. CORRECTED DRAIN NAME SHT 26
02	06/22/23	ADD WTR DIM PER PITTSFIELD, CORRECTED 6" WTR SHT 18
03	06/30/23	ADD WTR & SAN SRV SHTS 10,17&18. DEPTH NOTE SHT 18
04	08/30/23	REV PER CITY OF YPSI COMMENTS. ADD SHTS 38 & 39

PEDESTRIAN DETOUR - MANSFIELD ST TO OAKWOOD ST

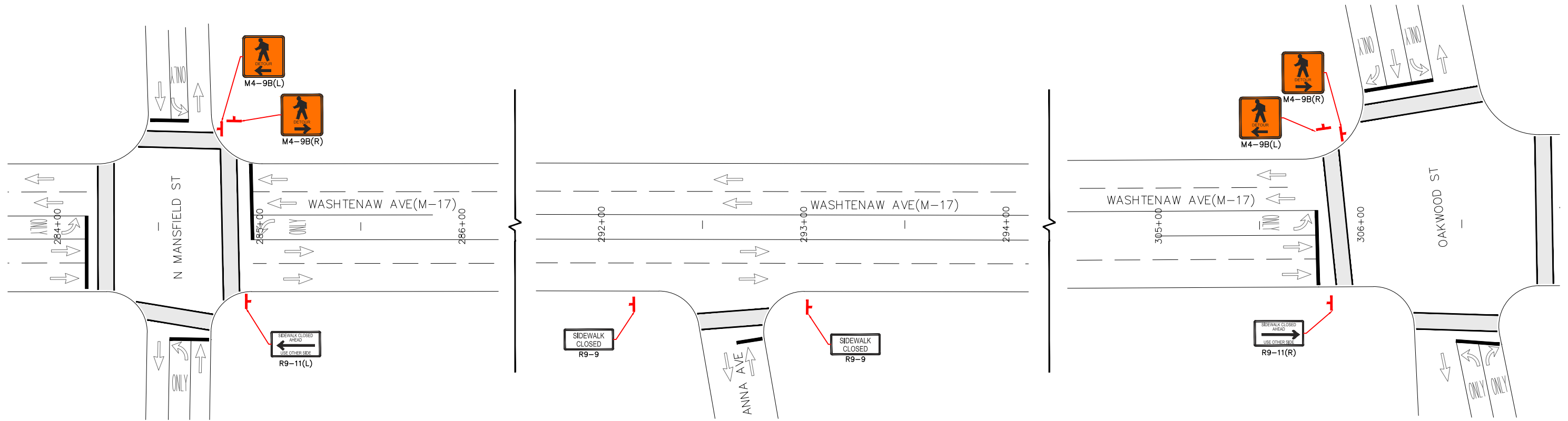

THE LOCATIONS OF EXISTING UNDERGROUND UTILITIES ARE SHOWN IN AN APPROXIMATE WAY ONLY AND HAVE NOT BEEN INDEPENDENTLY VERIFIED. THE CONTRACTOR SHALL DETERMINE THE EXACT LOCATION OF ALL EXISTING UTILITIES BEFORE COMMENCING WORK, AND AGREES TO BE FULLY RESPONSIBLE FOR ANY AND ALL DAMAGES WHICH MIGHT BE OCCASIONED BY THE CONTRACTOR'S FAILURE TO EXACTLY LOCATE AND PRESERVE ANY AND ALL UNDERGROUND UTILITIES.

REVISION		
REV #	DATE	DESCRIPTION
01	05/30/23	ADDED DRAIN DETAIL SHT 15. CORRECTED DRAIN NAME SHT 26
02	06/22/23	ADD WTR DIM PER PITTSFIELD, CORRECTED 6" WTR SHT 18
03	06/30/23	ADD WTR & SAN SRV SHTS 10,17&18. DEPTH NOTE SHT 18
04	08/30/23	REV PER CITY OF YPSI COMMENTS. ADD SHTS 38 & 39

METRO ENGINEERING SOLUTIONS
 33900 SCHOOLCRAFT RD
 LIVONIA, MICHIGAN 48150
 PHONE: 734.483.1427 FAX: 734.483.3431
 www.metroes.net

NORTH ROUTE - EAST OF U.S. 23	
MES JOB# 1043-22	DRAWN - KMM
PLOT SCALE = 1" = 50'	CHECKED - JB
PLAN DATE = 05/11/2023	

ANN ARBOR SPARK
 CORRIDOR FIBER OPTIC BACKBONE PROJECT
 ANN ARBOR
 WASHTENAW COUNTY, MI

PERMITS REQUIRED:		
<input type="checkbox"/> CITY OF ANN ARBOR	<input checked="" type="checkbox"/> CITY OF YPSILANTI	<input type="checkbox"/> EGLE
<input checked="" type="checkbox"/> WASHTENAW COUNTY	<input checked="" type="checkbox"/> YPSILANTI TOWNSHIP	<input type="checkbox"/> RR
<input checked="" type="checkbox"/> WASHTENAW COUNTY DRAIN	<input checked="" type="checkbox"/> PITTSFIELD TOWNSHIP	<input checked="" type="checkbox"/> MDOT

SHEET INFORMATION	
TOTAL SHEETS	SHEET NO.
39	39

K:\2022\1043 JOB FOLDERS\CAD Resources\Titleblocks\North Route - West of U.S.-23\North Route - West of 23_Cover.dwg: 8/22/2023 12:59 PM;

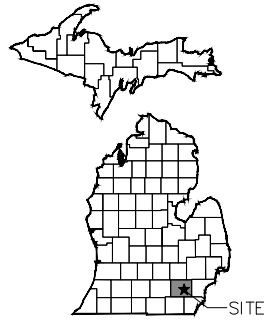

**EDA Project Number:
06-79-06299**



WASHTENAW COUNTY, MI

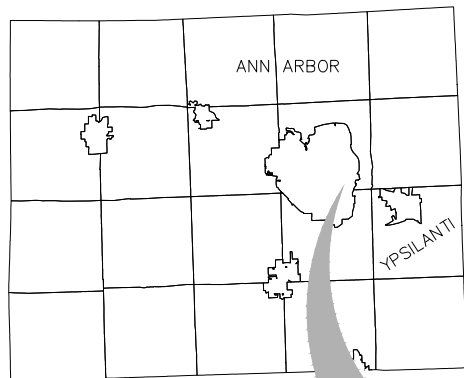

PERMITTING AGENCIES

MUNICIPALITY:

CITY OF ANN ARBOR
301 E HURON
P.O. BOX 8647
ANN ARBOR, MI 48107
(734) 794-6320

DRAIN:

WASHTENAW COUNTY
WATER RESOURCE COMMISSION
705 N ZEEB ROAD
ANN ARBOR, MI 48103

DOT:

MDOT
BRIGHTON TSC
10321 E GRAND RIVER, SUITE 500
BRIGHTON, MI 48116
(810)227-4681

SHEET INDEX

SHEET #(s)	DESCRIPTION
01	LOCATOR MAP & INDEX
02	NOTES
03	HANDHOLE & FIBER MARKER DETAIL
04	SPLICE & SLACK DETAILS
05	BLANK SHEET
06-26	PLAN SHEETS & CROSS SECTIONS



August 28, 2023

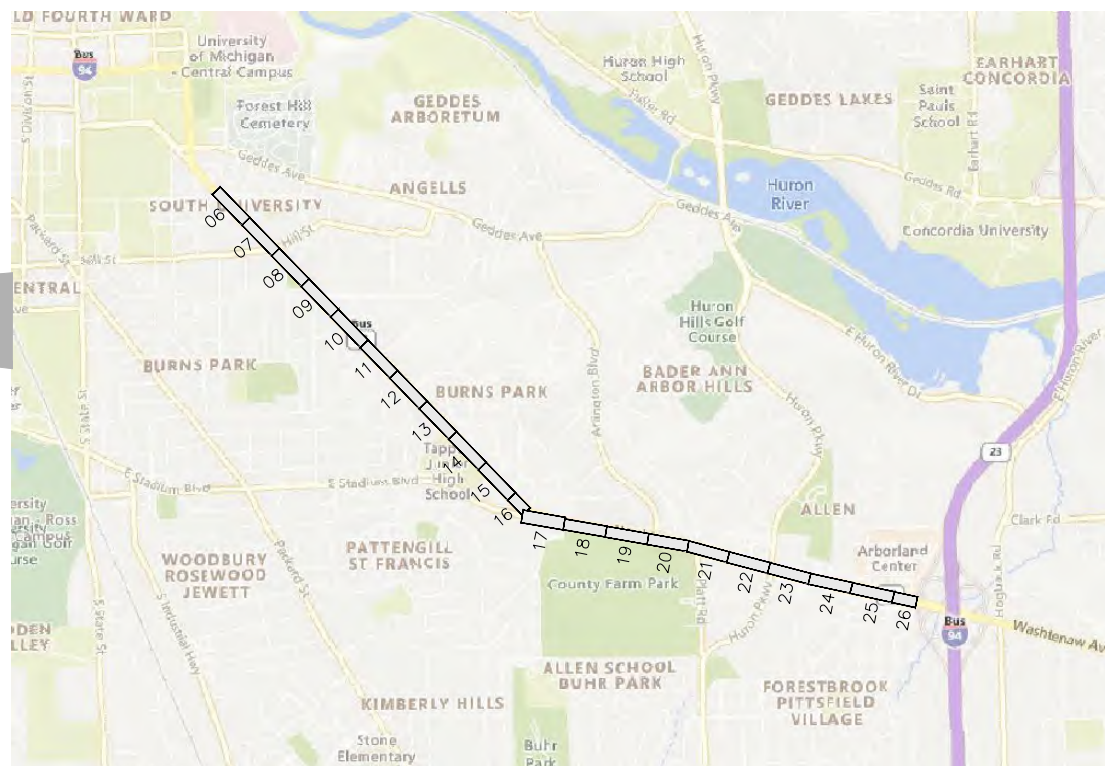

ANN ARBOR SPARK FIBER BACKBONE INFRASTRUCTURE
THIS PROJECT WILL PLACE INFRASTRUCTURE FOR THE
PLACEMENT OF FIBER OPTIC CABLE TO CONNECT THE
CITY OF ANN ARBOR WITH THE CITY OF YPSILANTI

LEGEND

- R/W — EX. RIGHT OF WAY
- EX. EASEMENT LINE
- - - - - EX. DITCH
- - - - - EX. GRAVEL
- - - - - EX. WETLAND LIMITS
- ==== EX. CURB/PAVEMENT
- ++++ EX. RR TRACK
- EX. FENCE(STEEL)
- EX. FENCE(WOOD)
- EX. GUARDRAIL
- ~~~~~ EX. TREELINE
- EX. WATER MAIN
- EX. STORM SEWER
- EX. SANITARY SEWER
- EX. UND GAS
- ~~~~~ EX. UND ELECTRIC
- EX. UND TELE
- JOINT TRENCH (POWER,TELE,CABLE)
- EX. UND CABLE
- EX. UND STEAM
- EX. OH ELECTRIC
- EX. WATER VALVE
- EX. HYDRANT
- EX. WATER MANHOLE
- EX. STORM INLET/CATCH BASIN
- EX. ROUND STORM CATCH BASIN
- EX. STORM MANHOLE
- EX. STORM END SECTION
- EX. SANITARY MANHOLE
- EX. STEAM MANHOLE
- EX. GAS VALVE
- EX. GAS METER
- EX. ELECTRIC MANHOLE
- EX. ELECTRIC TRANS
- EX. UTILITY POLE
- EX. LIGHT POLE
- EX. TRAFFIC SIGNAL POLE
- EX. GUY WIRE
- EX. TELE MANHOLE
- EX. TELE PED
- EX. UNIDENTIFIED MANHOLE
- EX. TREE
- EX. SIGN
- PROP DESIGN UND
- PROP HANDHOLE
- PROP SIDEWALK RESTORATION
- PROP UTILITY CROSSING
- PROP FIBER MARKER POST

REVISION

REV #	DATE	DESCRIPTION
01	06/07/23	CORRECTED DRAIN CROSSING SHT 23
02	07/10/23	ADD BORE PIT DIM SHT 06. DEPTH NOTE ADDED SHTS 18-20
03	07/18/23	REVISED PER CITY OF ANN ARBOR COMMENTS
04	07/25/23	REVISED PER AA FORESTRY COMMENTS
05	08/22/23	REVISED PER CITY OF ANN ARBOR COMMENTS
06	08/28/23	REVISED PER CITY OF ANN ARBOR COMMENTS



THE LOCATIONS OF EXISTING UNDERGROUND UTILITIES ARE SHOWN IN AN APPROXIMATE WAY ONLY AND HAVE NOT BEEN INDEPENDENTLY VERIFIED. THE CONTRACTOR SHALL DETERMINE THE EXACT LOCATION OF ALL EXISTING UTILITIES BEFORE COMMENCING WORK, AND AGREES TO BE FULLY RESPONSIBLE FOR ANY AND ALL DAMAGES WHICH MIGHT BE OCCASIONED BY THE CONTRACTOR'S FAILURE TO EXACTLY LOCATE AND PRESERVE ANY AND ALL UNDERGROUND UTILITIES.



33900 SCHOOLCRAFT RD
LIVONIA, MICHIGAN 48150
PHONE: 734.483.1427 FAX: 734.483.3431
www.metroes.net

NORTH ROUTE - WEST OF U.S. 23

MES JOB#	1043-22	DRAWN	KMM
PLOT SCALE	= 1" = 50'	CHECKED	JB
PLAN DATE	= 05/09/2023		

ANN ARBOR SPARK

CORRIDOR FIBER OPTIC BACKBONE PROJECT
ANN ARBOR
WASHTENAW COUNTY, MI

PERMITS REQUIRED:

<input checked="" type="checkbox"/> CITY OF ANN ARBOR	<input type="checkbox"/> CITY OF YPSILANTI	<input type="checkbox"/> EGLE
<input type="checkbox"/> WASHTENAW COUNTY	<input type="checkbox"/> YPSILANTI TOWNSHIP	<input type="checkbox"/> RR
<input checked="" type="checkbox"/> WASHTENAW COUNTY DRAIN	<input type="checkbox"/> PITTSFIELD TOWNSHIP	<input checked="" type="checkbox"/> MDOT

SHEET INFORMATION

TOTAL SHEETS	SHEET NO.
26	01

GENERAL REQUIREMENTS

- A. ALL WORK PERFORMED BY THE CONTRACTOR SHALL BE IN ACCORDANCE WITH THE CITY'S SPECIFICATIONS AND ALL APPLICABLE STANDARDS INCLUDED BUT NOT LIMITED TO THE FOLLOWING:
a. ANSI, ATIS, ASTM, BOCA, BICSI, EIA, IEEE, MI-OSHA, NEMA NESC, NFPA, OSHA, TIA, UL, AND ANY OTHER APPLICABLE INDUSTRY STANDARD(S).
- B. ALL TRAFFIC CONTROL NEEDED TO PERFORM ANY AND ALL PORTIONS OF THE WORK IS THE RESPONSIBILITY OF THE CONTRACTOR AND SHALL BE INCLUDED IN THE COST, REGARDLESS OF THE NUMBER OF TRAFFIC CONTROL MOBILIZATIONS AND SETUPS REQUIRED.
- C. ANY DAMAGE TO AND NOT LIMITED TO: LANDSCAPING, PRIVATE PROPERTY, UNIVERSITY OF MICHIGAN PROPERTY, ROADS, CURB AND GUTTER, SIDEWALK, OR EXISTING UTILITIES SHALL BE REPAIRED BY THE CONTRACTOR AND/OR ANY THEIR SUB-CONTRACTOR(S) IMMEDIATELY AT NO COST TO THE PROJECT.
- D. THE CONTRACTOR SHALL CONFINE WORK TO ROW PROPERTY AT ALL TIMES. AT NO TIME, SHALL THE CONTRACTOR ENTER PRIVATE PROPERTY, UNIVERSITY OF MICHIGAN PROPERTY, OR PERFORM ANY WORK NOT AUTHORIZED BY THE CITY OF ANN ARBOR.
- E. THE CONTRACTOR IS RESPONSIBLE FOR LOCATING ALL EXISTING UNDERGROUND SERVICES INCLUDING: ELECTRIC, GAS, TELEPHONE, DATA, WATER, AND SEWER PRIOR TO BEGINNING ANY UNDERGROUND WORK. COORDINATION AND COMPLIANCE WITH MISS DIG ARE REQUIRED.
- F. THE CONTRACTOR WILL PROVIDE EXPERIENCED INSTALLERS WHO ARE LICENSED OR CERTIFIED TO INSTALL CORNING FIBER MANUFACTURED MATERIAL.
- G. THE CONTRACTOR IS REQUIRED TO FACILITATE INSPECTIONS OF WORK WITH CITY OF ANN ARBOR AND THE CITY'S DESIGNATED REPRESENTATIVE (DESIGN, ENGINEERING SERVICES CONTRACTOR) THAT IS PROVIDING CONSTRUCTION OVERSITE UNDER A SEPARATE CONTRACT. ANY DEFICIENCIES REVEALED DURING INSPECTIONS BY CITY AND/OR DESIGNATED REPRESENTATIVES OF THE CITY OF ANN ARBOR, ARE THE SOLE RESPONSIBILITY OF THE CONTRACTOR TO RESOLVE.
- H. WHEN CONSTRUCTION IS COMPLETED, THE CONTRACTOR SHALL PERFORM CONTINUITY TESTING OF OPTICAL FIBERS USING OTDR AND INDUSTRY STANDARDS FOR TESTING. REFER TO SECTION "ACCEPTANCE AND TESTING" FOR REQUIREMENTS.
- I. THE CONTRACTOR SHALL INSTALL NECESSARY LIGHTING PROTECTION IN ACCORDANCE WITH AFOREMENTIONED STANDARDS.
- J. GROUNDING FOR UNDERGROUND NETWORK SEGMENTS IS REQUIRED AT EVERY SPLICE ENCLOSURE WITH A MINIMUM OF 8 (EIGHT) FEET OF GROUNDING ROD. GROUNDING RODS MUST MEET APPLICABLE INDUSTRY STANDARD SPECIFICATIONS.
- K. THE CONTRACTOR MUST ENSURE ADEQUATE CLEARANCE EXISTS BETWEEN PROPOSED FIBER BUILD AND OTHER UTILITIES, GROUND, RAIL, ROADS, AND WATER. AT A MINIMUM THE CONTRACTOR IS REQUIRED TO BUILD CONFORMING TO NESC CODES AND CITY OF ANN ARBOR STANDARD SPECIFICATIONS.
- L. THE CONTRACTOR IS ALSO RESPONSIBLE TO VERIFY LOCAL UTILITIES DO NOT HAVE MORE STRINGENT CLEARANCE CODES.
- M. THE CONTRACTOR IS RESPONSIBLE FOR ADHERING TO ALL RIGHT-OF-WAY AND UTILITY PERMITTING TERMS AND CONDITIONS AS SET FORTH IN EACH RIGHT-OF-WAY PERMIT.
- N. ANY CONSTRUCTION CHANGES MUST BE PRE-APPROVED BY THE CITY OF ANN ARBOR AND THE CITY OF ANN ARBOR'S DESIGN AND PLANNING CONTRACTOR BEFORE COMMENCING WITH SAID CHANGE. REDLINE EDITED DRAWINGS IN AUTOCAD FORMAT WILL BE REQUIRED TO DOCUMENT ANY APPROVED CHANGES.
- O. IF DEFICIENCIES AND/OR NON-COMPLIANCE ISSUES ARE DISCOVERED BY THE CITY OF ANN ARBOR PROJECT MANAGER OR THE CITY OR ANN ARBOR'S DESIGN AND PLANNING CONTRACTOR THE CONTRACTOR IS RESPONSIBLE FOR THE CORRECTION.
- P. THE CONTRACTOR IS RESPONSIBLE FOR ALL JOBSITE CLEANUP AND FOR REMOVAL OF ALL SPENT FIBER REELS AND OTHER MATERIALS USED DURING CONSTRUCTION.
- Q. CONSTRUCTION WILL BE SUBJECT TO PERIODIC INSPECTIONS BY CORNING AND THE CONSTRUCTION CONTRACTOR MUST COMPLY WITH ANY MODIFICATIONS MADE BY CORNING IN ORDER FOR THE CITY TO MAINTAIN ITS CORNING WARRANTY
- R. THE CONTRACTOR IS RESPONSIBLE FOR THE RESTORATION OF THE WORK AREA, INCLUDING LANDSCAPING, TO ITS ORIGINAL CONDITION AFTER WORK IS COMPLETE. SURROUNDING AREA MUST BE FILLED, LEVELED, AND COMPACTED. IF GRASS RESTORATION IS REQUIRED, CONTRACTOR MUST APPLY SEED OR HYDRO SEED. IF WORK CANNOT BE COMPLETED DUE TO UNSEASONAL CONDITIONS, THE WORK WILL BE COMPLETED WHEN FEASIBLE AND WITHIN THE 1-YEAR WARRANTY PERIOD. PAYMENT FOR PROJECTS WITH OUTSTANDING WORK DUE TO UNSEASONAL CONDITIONS WILL BE NEGOTIATED ON A PER PROJECT BASIS. AN ACTIVE PROJECT PUNCH LIST OF ITEMS WILL BE DOCUMENTED AND TRACKED BY THE CITY OF ANN ARBOR PROJECT MANAGER UNTIL ALL WORK HAS BEEN COMPLETED.
- S. IF POTHOLING IS REQUIRED IN SIDEWALK CONCRETE THE ENTIRE CONCRETE SLAB MUST BE RESTORED, NOT JUST THE POTHOLE AREA

M-DOT NOTES:

- A) DIRECTIONAL DRILLING SHALL BE CONSTRUCTED PER THE MDOT TRENCHLESS SPECIFICATION 3703A.
- B) NO PARKING OR STORAGE OF MATERIAL OR EQUIPMENT WILL BE ALLOWED WITHIN THE M-DOT RIGHT-OF-WAY.
- C) REMOVE AND REPLACE SIDEWALK AS DIRECTED BY THE FIELD INSPECTOR. UNLESS OTHERWISE SPECIFIED, ANY DAMAGED SIDEWALK SHALL BE REPLACED IN ACCORDANCE TO MDOT STANDARD DETAILS R-29 SERIES AND R-28 SERIES FOR SIDEWALK RAMPS.
- D) NO OPEN EXCAVATION SHALL REMAIN OVERNIGHT. ALL ACCESS PITS, OPEN EXCAVATION, EQUIPMENT AND SUPPLIES SHALL BE PROTECTED WITH SUITABLE FENCING AND PLASTIC DRUMS TO PROHIBIT PEDESTRIAN ACCESS TO THE WORK SITE. EQUIPMENT SHALL NOT BE USED AS FENCING TO PROTECT ACCESS PITS.
- E) A SAFE AND ADEQUATE TRAVEL ROUTE FOR PEDESTRIANS SHALL BE MAINTAINED AT ALL TIMES. PEDESTRIANS SHALL NOT BE DETOURED INTO THE ROADWAY OR DIRECTED TO CROSS THE TRUNKLINE AT NON SIGNALIZED INTERSECTIONS.
- F) ALL TRAFFIC CONTROL DEVICES INCLUDING SIGNS AND PAVEMENT MARKINGS (REMOVAL AND INSTALLATIONS) SHALL BE MAINTAINED AND/OR INSTALLED IN ACCORDANCE WITH CURRENT MDOT STANDARDS AND SPECIFICATIONS. CHARGES ARE THE SOLE RESPONSIBILITY OF THE PERMITTED.
- G) PERMITTEE AND CONTRACTORS ARE SUBJECT TO: PART 201, PUBLIC ACT 451 OF 1994, AS AMENDED. IN THE EVENT OF EXCAVATION ENCOUNTERING ENVIRONMENTAL CONTAMINATION OR AN UNDERGROUND TANK IN MDOT RIGHT-OF-WAY, WORK WITHIN THE RIGHT OF WAY SHALL CEASE UNTIL ALL ACTIONS/NOTIFICATIONS SPECIFIED BY PART 201 HAVE BEEN COMPLETED.
- H) PERMITTEE AND CONTRACTORS ARE SUBJECT TO PART 91, PUBLIC ACT 451 OF 1994, AS AMENDED. SOIL EROSION AND SEDIMENTATION CONTROL.
- I) ALL TRAFFIC CONTROL DEVICES USED ON THIS PERMIT SHALL MEET THE REQUIREMENTS OF THE "MICHIGAN MANUAL OF UNIFORM TRAFFIC CONTROL DEVICES," (MMUTCD) CURRENT EDITION, AND THE AMERICAN TRAFFIC SAFETY ASSOCIATION (ATSA) "QUALITY DEVICES ARE INCLUSIVE OF BUT NOT LIMITED TO SIGNS, BARRICADES, VERTICAL PANELS, DRUMS, WARNING LIGHTS, ARROW BOARDS, CHANGEABLE MESSAGE SIGNS, CONES, TUBULAR MARKERS, PAVEMENT TAPE, PAINT AND PAVEMENT MARKERS.
- J) ALL UTILITIES INCLUDING DRAINAGE FACILITIES SHALL BE LOCATED PRIOR TO EXCAVATION IN THE MDOT RIGHT-OF-WAY. MDOT FACILITIES ARE NOT LOCATED THROUGH THE MISS DIG SYSTEM. CONTACT THE MDOT PERMIT UNIT FOR INSTRUCTIONS.
- K) THE CONTRACTOR SHALL HAVE A MICHIGAN DEPARTMENT OF TRANSPORTATION APPROVED PLAN AND PERMIT ON-SITE AT ALL TIMES.
- L) THE CONTRACTOR SHALL SUBMIT MDOT ADVANCE NOTICE THROUGH CPS A MINIMUM OF FIVE (5) DAYS PRIOR TO START OF CONSTRUCTION.
- M) THE CONTRACTOR SHALL CONTACT THE INSPECTION AGENCY AS SHOWN ON THE PERMIT 72 HOURS PRIOR TO START OF CONSTRUCTION.
- N) THE CONTRACTOR SHALL CONTACT THE INSPECTION AGENCY AS SHOWN ON THE PERMIT AT THE COMPLETION OF CONSTRUCTION FOR A FINAL INSPECTION.
- O) THE APPLICANT/CONTRACTOR IS REQUIRED TO SUBMIT A COMPLETION NOTIFICATION VIA CPS UPON COMPLETING ALL WORK COVERED UNDER THIS PERMIT.
- P) THE MDOT RIGHT-OF-WAY SHALL BE RESTORED TO PRE-WORK CONDITIONS OR BETTER.
- Q) ALL DRILLING FLUIDS SHALL NOT ENTER THE STREETS, MANHOLES, SANITARY AND STORM SEWERS, AND OTHER DRAINAGE SYSTEMS, INCLUDING STREAMS AND RIVERS.

GENERAL CONSTRUCTION NOTES

- A. SODDED AREAS THAT MAY BE DISTURBED DURING INSTALLATION ARE TO BE RESTORED WITH 3" OF QUALITY TOP SOIL, SEED AND MULCH
- B. MAINTAIN A MINIMUM 18" CLEARANCE FROM ALL EXISTING PUBLIC UTILITIES
- C. PROPOSED INSTALLATION TO BE PLACED AT A MINIMUM DEPTH OF 48", UNLESS OTHERWISE NOTED ON PLANS
- D. SIDEWALK REMOVAL NECESSARY ON THIS PROJECT TO BE ACCOMPLISHED IN COMPLETE FLAGS AND REPLACED IN KIND PER JURISDICTIONAL SPECIFICATIONS
- E. HARD SURFACE REMOVAL OF STREETS AND/OR DRIVEWAYS TO BE SAW CUT FULL DEPTH AND REPLACED IN KIND PER JURISDICTIONAL SPECIFICATIONS
- F. CONTRACTOR TO FIELD VERIFY ALL EXISTING UTILITY LOCATIONS, INVERTS AND GRADES PRIOR TO STARTING CONSTRUCTION
- G. EXCAVATIONS BELOW HARD SURFACES TO BE BACKFILLED WITH MDOT CLASS II GRANULAR MATERIAL IN 8" LAYERS, WELL COMPACTED TO 98% OF ITS MAXIMUM UNIT WEIGHT AT A MOISTURE CONTENT LESS THAN SATURATION
- H. TEST HOLES TO BE CONSTRUCTED AS A 12" CYLINDRICAL HOLE. SOIL TO BE REMOVED USING A VACUUM TRUCK. HOLE TO BE BACKFILLED USING A GRANULAR MATERIAL TO THE BOTTOM OF THE EXISTING PAVEMENT. PAVEMENT TO BE REPLACED IN KIND PER MDOT SPECIFICATIONS

ENGINEER ESTIMATE OF MATERIALS	
QTY	ITEM
14889	LINEAR FT OF 2-2" HDPE SDR-11 FOR FIBER
17	30"X48"X36" FIBERGLASS HAND HOLE
17289	LINEAR FT OF 432 STRAND FIBER CABLE
14889	LINEAR FT OF #6 TRACER WIRE
1	FIBER MARKER POST

REVISION		
REV #	DATE	DESCRIPTION
01	06/07/23	CORRECTED DRAIN CROSSING SHT 23
02	07/10/23	ADD BORE PIT DIM SHT 06. DEPTH NOTE ADDED SHTS 18-20
03	07/18/23	REVISED PER CITY OF ANN ARBOR COMMENTS
04	07/25/23	REVISED PER AA FORESTRY COMMENTS
05	08/22/23	REVISED PER CITY OF ANN ARBOR COMMENTS
06	08/28/23	REVISED PER CITY OF ANN ARBOR COMMENTS



THE LOCATIONS OF EXISTING UNDERGROUND UTILITIES ARE SHOWN IN AN APPROXIMATE WAY ONLY AND HAVE NOT BEEN INDEPENDENTLY VERIFIED. THE CONTRACTOR SHALL DETERMINE THE EXACT LOCATION OF ALL EXISTING UTILITIES BEFORE COMMENCING WORK, AND AGREES TO BE FULLY RESPONSIBLE FOR ANY AND ALL DAMAGES WHICH MIGHT BE OCCASIONED BY THE CONTRACTOR'S FAILURE TO EXACTLY LOCATE AND PRESERVE ANY AND ALL UNDERGROUND UTILITIES.

<p>33900 SCHOOLCRAFT RD LIVONIA, MICHIGAN 48150 PHONE: 734.483.1427 FAX: 734.483.3431 www.metroes.net</p>	NORTH ROUTE - WEST OF U.S. 23		ANN ARBOR SPARK		PERMITS REQUIRED:			SHEET INFORMATION				
	MES JOB#	1043-22	DRAWN	— KMM	CORRIDOR FIBER OPTIC BACKBONE PROJECT ANN ARBOR WASHTENAW COUNTY, MI	<input checked="" type="checkbox"/>	CITY OF ANN ARBOR	<input type="checkbox"/>	CITY OF YPSILANTI	<input type="checkbox"/>	EGL	
	PLOT SCALE	= 1" = 50'	CHECKED	- JB		<input type="checkbox"/>	WASHTENAW COUNTY	<input type="checkbox"/>	YPSILANTI TOWNSHIP	<input type="checkbox"/>	RR	
	PLAN DATE	= 05/09/2023				<input checked="" type="checkbox"/>	WASHTENAW COUNTY DRAIN	<input type="checkbox"/>	PITTSFIELD TOWNSHIP	<input checked="" type="checkbox"/>	MDOT	
											TOTAL SHEETS	SHEET NO.
											26	02

30"X48"X36" QUAZITE HAND HOLE & FIBER MARKER POST

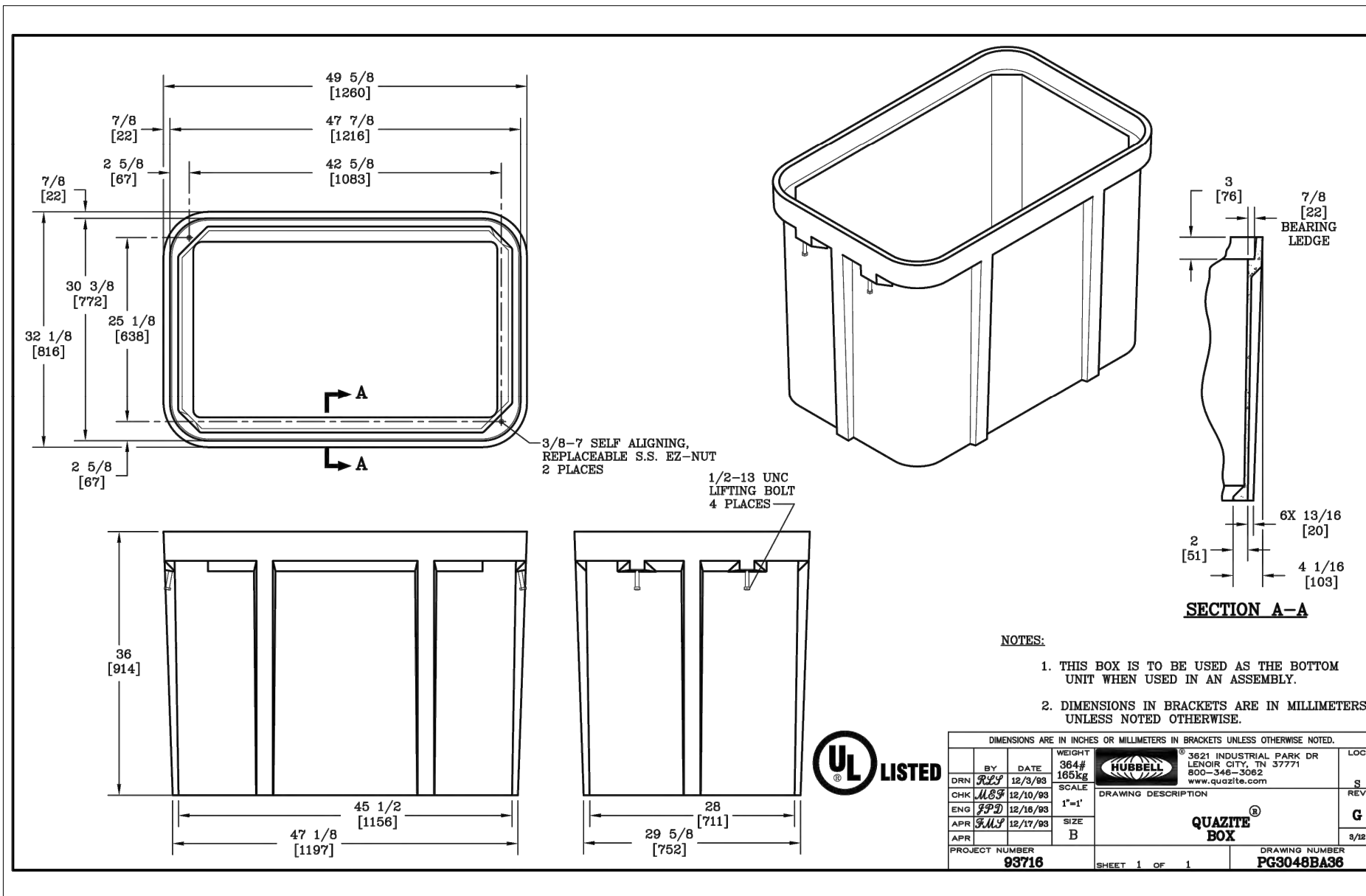

THE LOCATIONS OF EXISTING UNDERGROUND UTILITIES ARE SHOWN IN AN APPROXIMATE WAY ONLY AND HAVE NOT BEEN INDEPENDENTLY VERIFIED. THE CONTRACTOR SHALL DETERMINE THE EXACT LOCATION OF ALL EXISTING UTILITIES BEFORE COMMENCING WORK, AND AGREES TO BE FULLY RESPONSIBLE FOR ANY AND ALL DAMAGES WHICH MIGHT BE OCCASIONED BY THE CONTRACTOR'S FAILURE TO EXACTLY LOCATE AND PRESERVE ANY AND ALL UNDERGROUND UTILITIES.

REVISION		
REV #	DATE	DESCRIPTION
01	06/07/23	CORRECTED DRAIN CROSSING SHT 23
02	07/10/23	ADD BORE PIT DIM SHT 06. DEPTH NOTE ADDED SHTS 18-20
03	07/18/23	REVISED PER CITY OF ANN ARBOR COMMENTS
04	07/25/23	REVISED PER AA FORESTRY COMMENTS
05	08/22/23	REVISED PER CITY OF ANN ARBOR COMMENTS
06	08/28/23	REVISED PER CITY OF ANN ARBOR COMMENTS

METRO ENGINEERING SOLUTIONS
 33900 SCHOOLCRAFT RD
 LIVONIA, MICHIGAN 48150
 PHONE: 734.483.1427 FAX: 734.483.3431
 www.metroes.net

NORTH ROUTE - WEST OF U.S. 23	
MES JOB# 1043-22	DRAWN - KMM
PLOT SCALE = 1" = 50'	CHECKED - JB
PLAN DATE = 05/09/2023	

ANN ARBOR SPARK
 CORRIDOR FIBER OPTIC BACKBONE PROJECT
 ANN ARBOR
 WASHTENAW COUNTY, MI

PERMITS REQUIRED:

<input checked="" type="checkbox"/> CITY OF ANN ARBOR	<input type="checkbox"/> CITY OF YPSILANTI	<input type="checkbox"/> EGLE
<input type="checkbox"/> WASHTENAW COUNTY	<input type="checkbox"/> YPSILANTI TOWNSHIP	<input type="checkbox"/> RR
<input checked="" type="checkbox"/> WASHTENAW COUNTY DRAIN	<input type="checkbox"/> PITTSFIELD TOWNSHIP	<input checked="" type="checkbox"/> MDOT

SHEET INFORMATION

TOTAL SHEETS	SHEET NO.
26	03

K:\2022\1043 JOB FOLDERS\CAD Resources\Titleblocks\North Route- West of US-23\North Route- West of 23_Cover.dwg: 8/22/2023 12:59 PM:

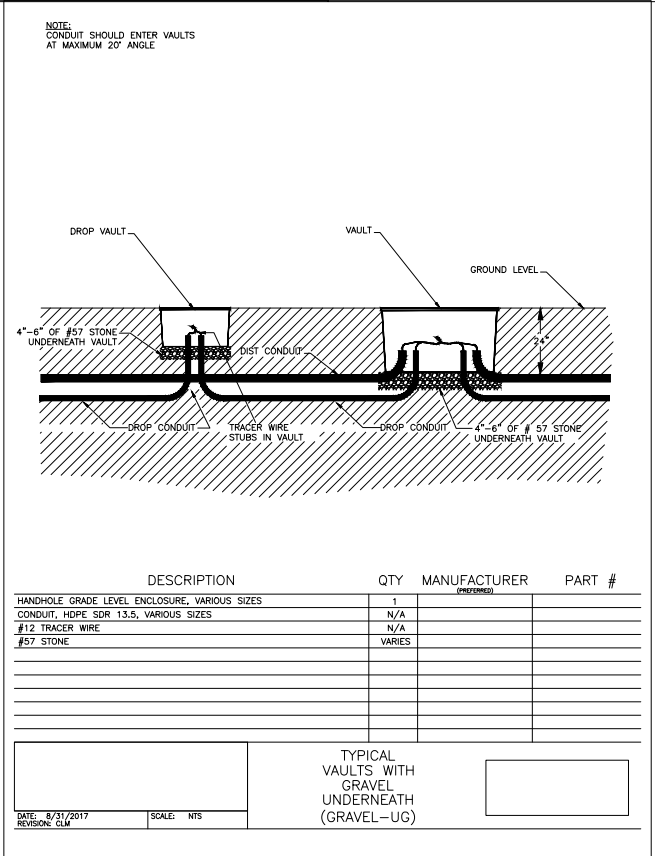
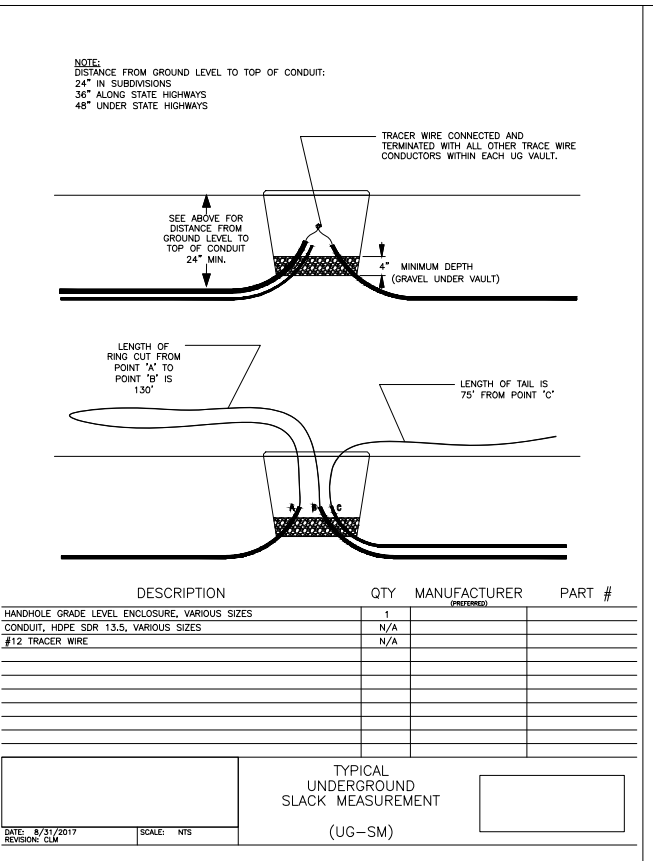
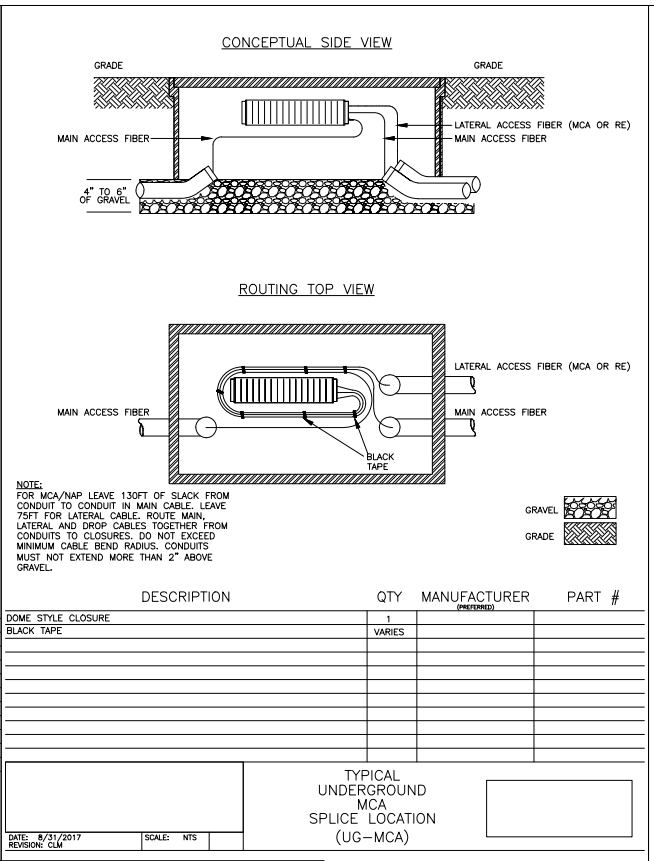
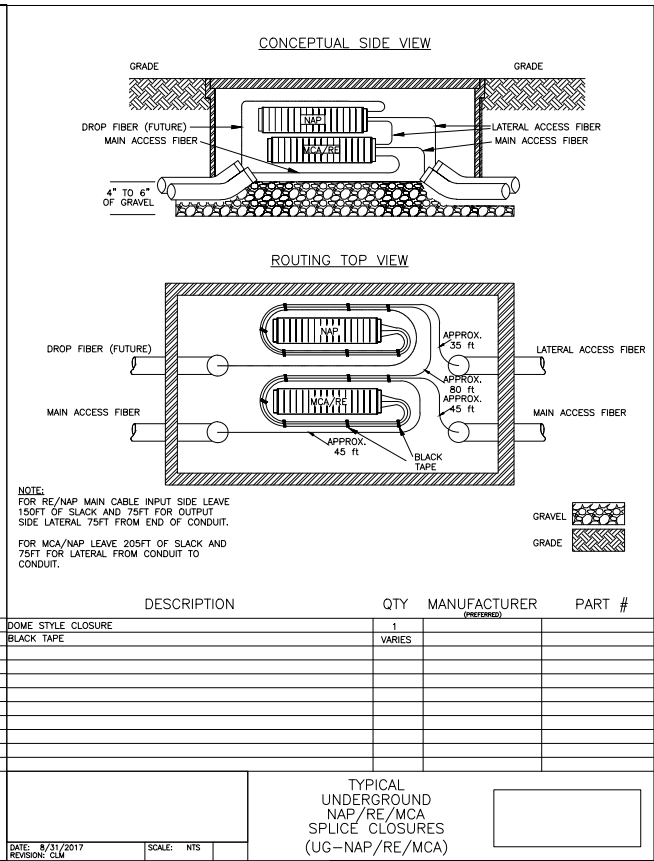
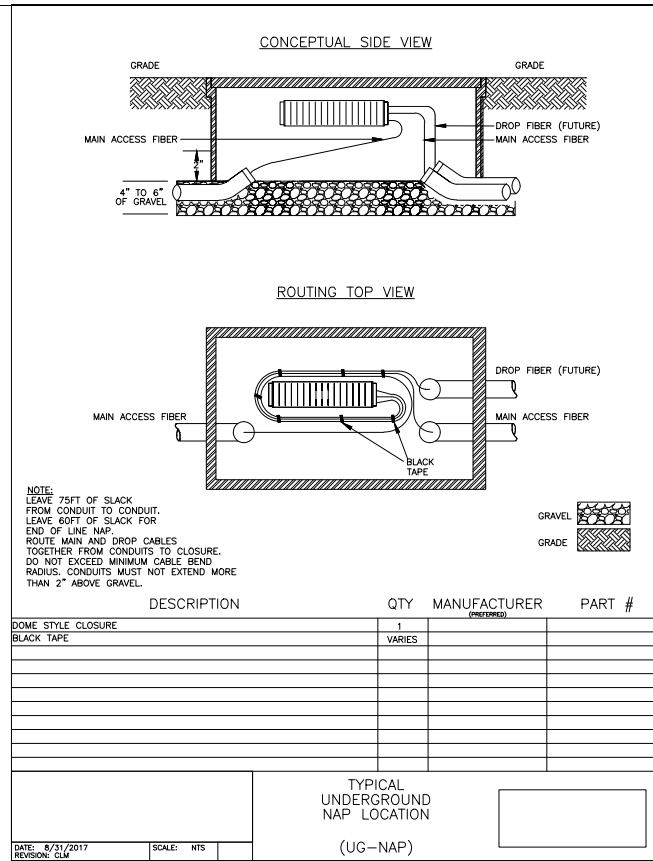

CAUTION
FIBER OPTIC CABLE

BB OF 45 CABLE ID: CABLE COUNT:

- CABLE ID TAGS ARE REQUIRED WHERE THERE ARE MULTIPLE CABLES WITHIN THE UG VAULTS

- SNAP TAGS ARE REQUIRED WHERE THERE ARE UG CABLES

REVISION		
REV #	DATE	DESCRIPTION
01	06/07/23	CORRECTED DRAIN CROSSING SHT 23
02	07/10/23	ADD BORE PIT DIM SHT 06. DEPTH NOTE ADDED SHTS 18-20
03	07/18/23	REVISED PER CITY OF ANN ARBOR COMMENTS
04	07/25/23	REVISED PER AA FORESTRY COMMENTS
05	08/22/23	REVISED PER CITY OF ANN ARBOR COMMENTS
06	08/28/23	REVISED PER CITY OF ANN ARBOR COMMENTS



THE LOCATIONS OF EXISTING UNDERGROUND UTILITIES ARE SHOWN IN AN APPROXIMATE WAY ONLY AND HAVE NOT BEEN INDEPENDENTLY VERIFIED. THE CONTRACTOR SHALL DETERMINE THE EXACT LOCATION OF ALL EXISTING UTILITIES BEFORE COMMENCING WORK, AND AGREES TO BE FULLY RESPONSIBLE FOR ANY AND ALL DAMAGES WHICH MIGHT BE OCCASIONED BY THE CONTRACTOR'S FAILURE TO EXACTLY LOCATE AND PRESERVE ANY AND ALL UNDERGROUND UTILITIES.

METRO ENGINEERING SOLUTIONS
33900 SCHOOLCRAFT RD
LIVONIA, MICHIGAN 48150
PHONE: 734.483.1427 FAX: 734.483.3431
www.metroes.net

NORTH ROUTE - WEST OF U.S. 23	
MES JOB# 1043-22	DRAWN - KMM
PLOT SCALE = 1" = 50'	CHECKED - JB
PLAN DATE = 05/09/2023	

ANN ARBOR SPARK
CORRIDOR FIBER OPTIC BACKBONE PROJECT
ANN ARBOR
WASHTENAW COUNTY, MI

PERMITS REQUIRED:		
<input checked="" type="checkbox"/> CITY OF ANN ARBOR	<input type="checkbox"/> CITY OF YPSILANTI	<input type="checkbox"/> EGLE
<input type="checkbox"/> WASHTENAW COUNTY	<input type="checkbox"/> YPSILANTI TOWNSHIP	<input type="checkbox"/> RR
<input checked="" type="checkbox"/> WASHTENAW COUNTY DRAIN	<input type="checkbox"/> PITTSFIELD TOWNSHIP	<input checked="" type="checkbox"/> MDOT

SHEET INFORMATION	
TOTAL SHEETS	SHEET NO.
26	04

K:\2022\1043 JOB FOLDERS\CAD Resources\Titleblocks\North Route - West of US-23\North Route- West of 23_Cover.dwg: 8/22/2023 12:59 PM;

THIS SHEET INTENTIONALLY LEFT BLANK



Know what's below.
Call before you dig.

THE LOCATIONS OF EXISTING UNDERGROUND UTILITIES ARE SHOWN IN AN APPROXIMATE WAY ONLY AND HAVE NOT BEEN INDEPENDENTLY VERIFIED. THE CONTRACTOR SHALL DETERMINE THE EXACT LOCATION OF ALL EXISTING UTILITIES BEFORE COMMENCING WORK, AND AGREES TO BE FULLY RESPONSIBLE FOR ANY AND ALL DAMAGES WHICH MIGHT BE OCCASIONED BY THE CONTRACTOR'S FAILURE TO EXACTLY LOCATE AND PRESERVE ANY AND ALL UNDERGROUND UTILITIES.

REVISION		
REV #	DATE	DESCRIPTION
01	06/07/23	CORRECTED DRAIN CROSSING SHT 23
02	07/10/23	ADD BORE PIT DIM SHT 06. DEPTH NOTE ADDED SHTS 18-20
03	07/18/23	REVISED PER CITY OF ANN ARBOR COMMENTS
04	07/25/23	REVISED PER AA FORESTRY COMMENTS
05	08/22/23	REVISED PER CITY OF ANN ARBOR COMMENTS
06	08/28/23	REVISED PER CITY OF ANN ARBOR COMMENTS

METRO ENGINEERING SOLUTIONS
33900 SCHOOLCRAFT RD
LIVONIA, MICHIGAN 48150
PHONE: 734.483.1427 FAX: 734.483.3431
www.metroes.net

NORTH ROUTE - WEST OF U.S. 23			
MES JOB#	1043-22	DRAWN	— KMM
PLOT SCALE	= 1" = 50'	CHECKED	- JB
PLAN DATE	= 05/09/2023		

ANN ARBOR SPARK
CORRIDOR FIBER OPTIC BACKBONE PROJECT
ANN ARBOR
WASHTENAW COUNTY, MI

PERMITS REQUIRED:					
<input checked="" type="checkbox"/>	CITY OF ANN ARBOR	<input type="checkbox"/>	CITY OF YPSILANTI	<input type="checkbox"/>	EGLE
<input type="checkbox"/>	WASHTENAW COUNTY	<input type="checkbox"/>	YPSILANTI TOWNSHIP	<input type="checkbox"/>	RR
<input checked="" type="checkbox"/>	WASHTENAW COUNTY DRAIN	<input type="checkbox"/>	PITTSFIELD TOWNSHIP	<input checked="" type="checkbox"/>	MDOT

SHEET INFORMATION	
TOTAL SHEETS	SHEET NO.
26	05

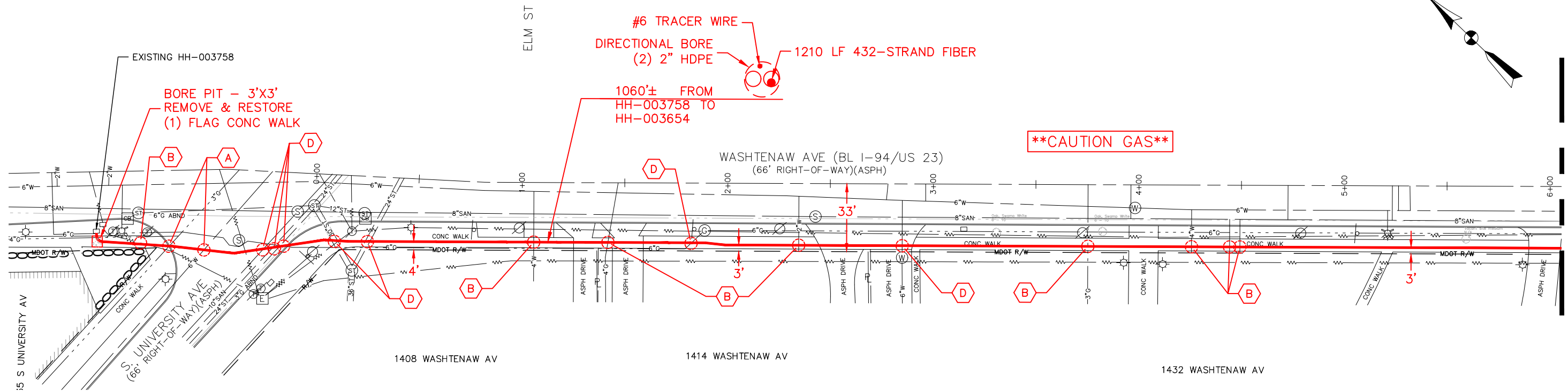
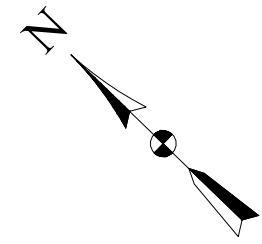

- UTILITY CROSSING/POTHOLE NOTES**
- A** POTHOLE. REMOVE & REPLACE (1) SQFT ASPH ROAD.
 - B** POTHOLE. REMOVE & REPLACE (1) FLAG CONC WALK.
 - C** POTHOLE. REMOVE & REPLACE GREENBELT.
 - D** NO POTHOLE NECESSARY. UTILITY DEPTH TO BE VERIFIED AT NEAREST STRUCTURE.

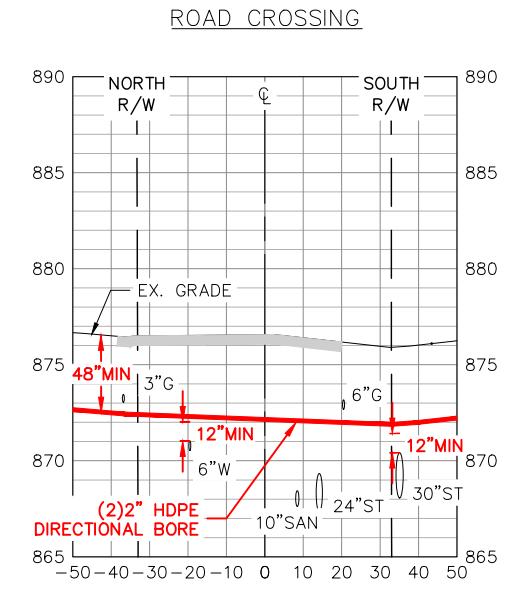

S. UNIVERSITY AVE
LOOKING EAST
1"=50' HORIZONTAL
1"=10' VERTICAL

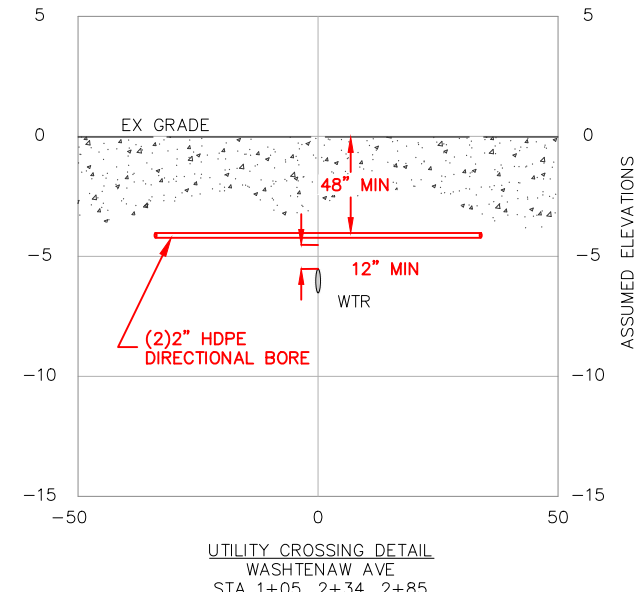

NOT TO SCALE

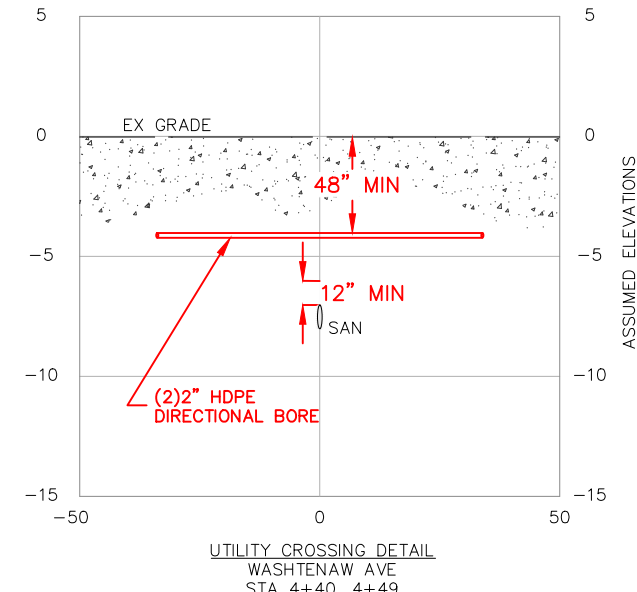

NOT TO SCALE

NOT TO SCALE		REVISION
REV #	DATE	DESCRIPTION
01	06/07/23	CORRECTED DRAIN CROSSING SHT 23
02	07/10/23	ADD BORE PIT DIM SHT 06. DEPTH NOTE ADDED SHTS 18-20
03	07/18/23	REVISED PER CITY OF ANN ARBOR COMMENTS
04	07/25/23	REVISED PER AA FORESTRY COMMENTS
05	08/22/23	REVISED PER CITY OF ANN ARBOR COMMENTS
06	08/28/23	REVISED PER CITY OF ANN ARBOR COMMENTS



THE LOCATIONS OF EXISTING UNDERGROUND UTILITIES ARE SHOWN IN AN APPROXIMATE WAY ONLY AND HAVE NOT BEEN INDEPENDENTLY VERIFIED. THE CONTRACTOR SHALL DETERMINE THE EXACT LOCATION OF ALL EXISTING UTILITIES BEFORE COMMENCING WORK, AND AGREES TO BE FULLY RESPONSIBLE FOR ANY AND ALL DAMAGES WHICH MIGHT BE OCCASIONED BY THE CONTRACTOR'S FAILURE TO EXACTLY LOCATE AND PRESERVE ANY AND ALL UNDERGROUND UTILITIES.

METRO ENGINEERING SOLUTIONS
33900 SCHOOLCRAFT RD
LIVONIA, MICHIGAN 48150
PHONE: 734.483.1427 FAX: 734.483.3431
www.metroes.net

NORTH ROUTE - WEST OF U.S. 23	
MES JOB# 1043-22	DRAWN - KMM
PLOT SCALE = 1" = 50'	CHECKED - JB
PLAN DATE = 05/09/2023	

ANN ARBOR SPARK
CORRIDOR FIBER OPTIC BACKBONE PROJECT
ANN ARBOR
WASHTENAW COUNTY, MI

PERMITS REQUIRED:

<input checked="" type="checkbox"/> CITY OF ANN ARBOR	<input type="checkbox"/> CITY OF YPSILANTI	<input type="checkbox"/> EGLE
<input type="checkbox"/> WASHTENAW COUNTY	<input type="checkbox"/> YPSILANTI TOWNSHIP	<input type="checkbox"/> RR
<input checked="" type="checkbox"/> WASHTENAW COUNTY DRAIN	<input type="checkbox"/> PITTSFIELD TOWNSHIP	<input checked="" type="checkbox"/> MDOT

SHEET INFORMATION

TOTAL SHEETS	SHEET NO.
26	06

K:\2022\1043 JOB FOLDERS\1043-22-0324\DWG\1043-22-0324_DS.dwg; 9/11/2023 9:03 AM;

MATCH LINE SHEET 07

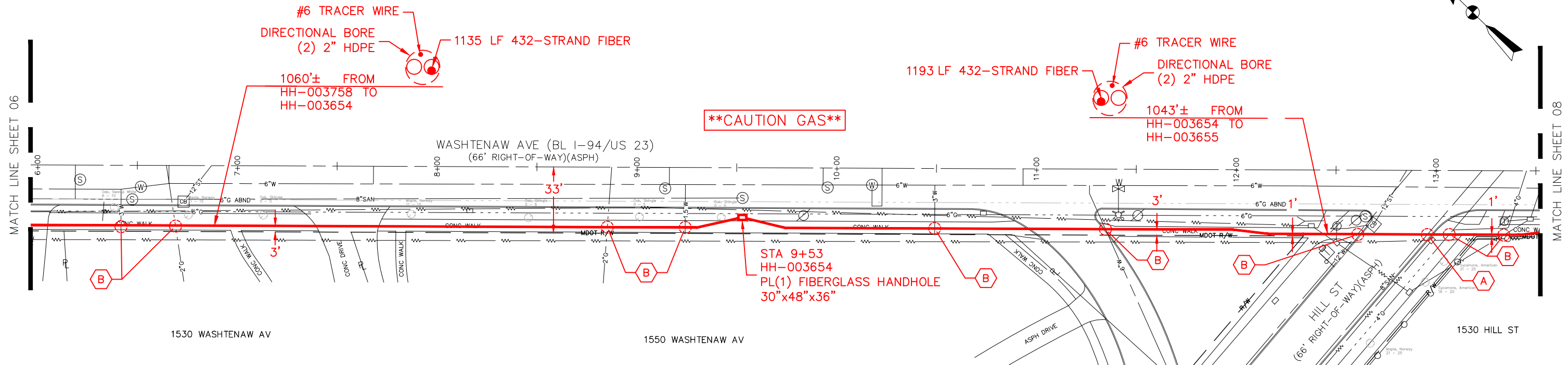
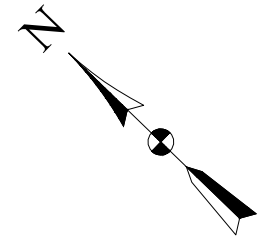

- UTILITY CROSSING/POTHOLE NOTES**
- (A)** POTHOLE. REMOVE & REPLACE (1) SQFT ASPH ROAD.
 - (B)** POTHOLE. REMOVE & REPLACE (1) FLAG CONC WALK.
 - (C)** POTHOLE. REMOVE & REPLACE GREENBELT.
 - (D)** NO POTHOLE NECESSARY. UTILITY DEPTH TO BE VERIFIED AT NEAREST STRUCTURE.

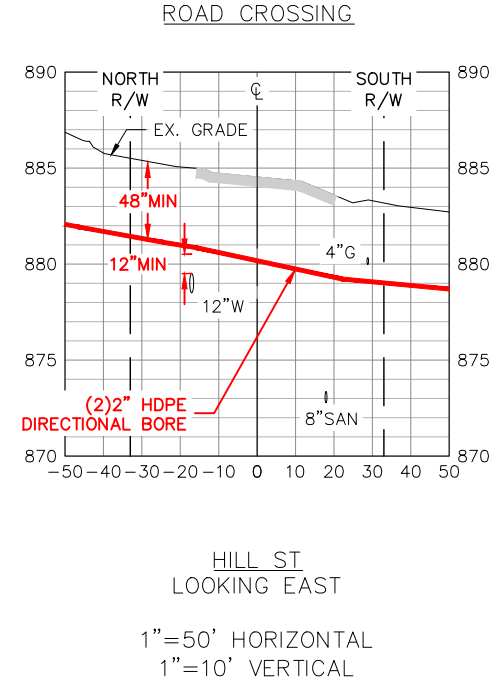
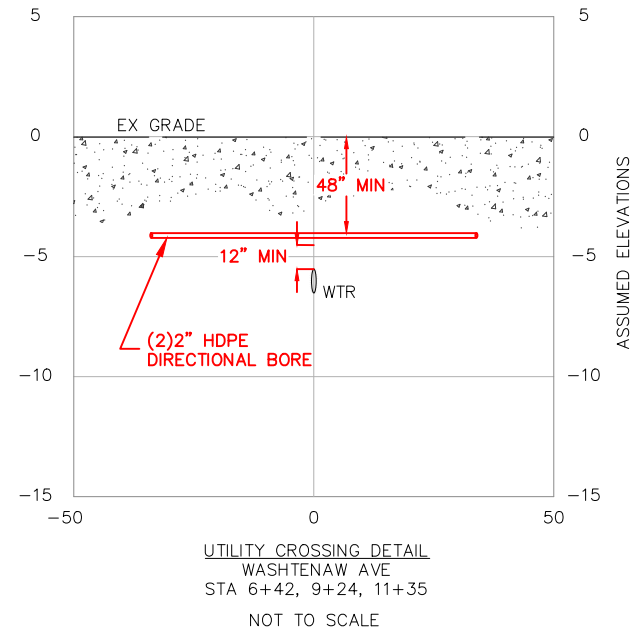

REVISION		
REV #	DATE	DESCRIPTION
01	06/07/23	CORRECTED DRAIN CROSSING SHT 23
02	07/10/23	ADD BORE PIT DIM SHT 06. DEPTH NOTE ADDED SHTS 18-20
03	07/18/23	REVISED PER CITY OF ANN ARBOR COMMENTS
04	07/25/23	REVISED PER AA FORESTRY COMMENTS
05	08/22/23	REVISED PER CITY OF ANN ARBOR COMMENTS
06	08/28/23	REVISED PER CITY OF ANN ARBOR COMMENTS



THE LOCATIONS OF EXISTING UNDERGROUND UTILITIES ARE SHOWN IN AN APPROXIMATE WAY ONLY AND HAVE NOT BEEN INDEPENDENTLY VERIFIED. THE CONTRACTOR SHALL DETERMINE THE EXACT LOCATION OF ALL EXISTING UTILITIES BEFORE COMMENCING WORK, AND AGREES TO BE FULLY RESPONSIBLE FOR ANY AND ALL DAMAGES WHICH MIGHT BE OCCASIONED BY THE CONTRACTOR'S FAILURE TO EXACTLY LOCATE AND PRESERVE ANY AND ALL UNDERGROUND UTILITIES.

METRO ENGINEERING SOLUTIONS
33900 SCHOOLCRAFT RD
LIVONIA, MICHIGAN 48150
PHONE: 734.483.1427 FAX: 734.483.3431
www.metroes.net

NORTH ROUTE - WEST OF U.S. 23	
MES JOB# 1043-22	DRAWN - KMM
PLOT SCALE = 1" = 50'	CHECKED - JB
PLAN DATE = 05/09/2023	

ANN ARBOR SPARK
CORRIDOR FIBER OPTIC BACKBONE PROJECT
ANN ARBOR
WASHTENAW COUNTY, MI

PERMITS REQUIRED:

<input checked="" type="checkbox"/> CITY OF ANN ARBOR	<input type="checkbox"/> CITY OF YPSILANTI	<input type="checkbox"/> EGLE
<input type="checkbox"/> WASHTENAW COUNTY	<input type="checkbox"/> YPSILANTI TOWNSHIP	<input type="checkbox"/> RR
<input checked="" type="checkbox"/> WASHTENAW COUNTY DRAIN	<input type="checkbox"/> PITTSFIELD TOWNSHIP	<input checked="" type="checkbox"/> MDOT

SHEET INFORMATION

TOTAL SHEETS	SHEET NO.
26	07

K:\2022\1043 JOB FOLDERS\1043-22-0324\DWG\1043-22-0324_DS.dwg; 8/28/2023 11:28 AM;

OXFORD RD

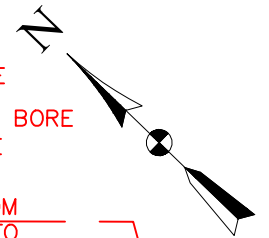

MATCH LINE SHEET 07

MATCH LINE SHEET 09

#6 TRACER WIRE
1193 LF 432-STRAND FIBER
DIRECTIONAL BORE
(2) 2" HDPE
1043'± FROM
HH-003654 TO
HH-003655

#6 TRACER WIRE
1150 LF 432-STRAND FIBER
DIRECTIONAL BORE
(2) 2" HDPE
1000'± FROM
HH-003655 TO
HH-003656

****CAUTION GAS****

- UTILITY CROSSING/POTHOLE NOTES**
- (A) POT HOLE. REMOVE & REPLACE (1) SQFT ASPH ROAD.
 - (B) POT HOLE. REMOVE & REPLACE (1) FLAG CONC WALK.
 - (C) POT HOLE. REMOVE & REPLACE GREENBELT.
 - (D) NO POT HOLE NECESSARY. UTILITY DEPTH TO BE VERIFIED AT NEAREST STRUCTURE.

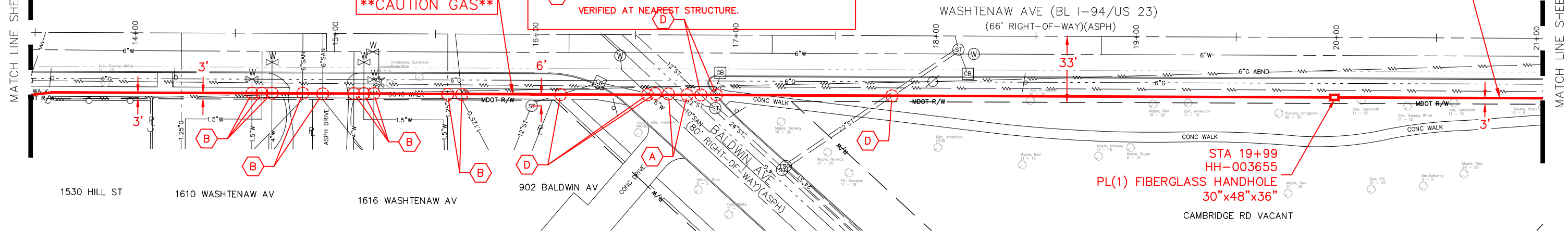

STA 19+99
HH-003655
PL(1) FIBERGLASS HANDHOLE
30"x48"x36"
CAMBRIDGE RD VACANT

ROAD CROSSING

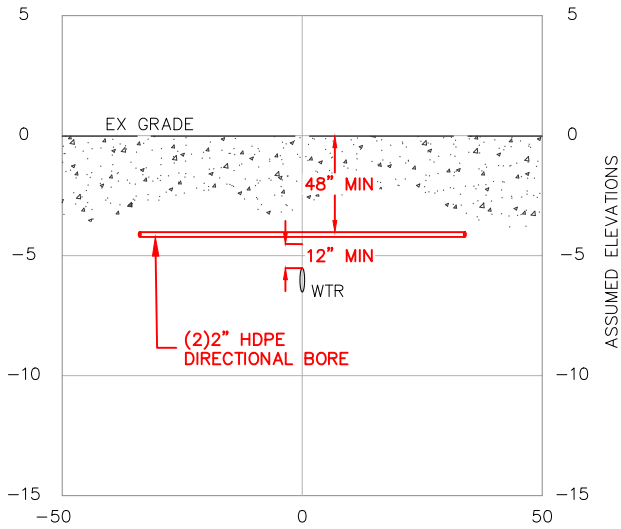

UTILITY CROSSING DETAIL
WASHTENAW AVE
STA 14+58, 14+63, 14+68,
15+09, 15+14
NOT TO SCALE

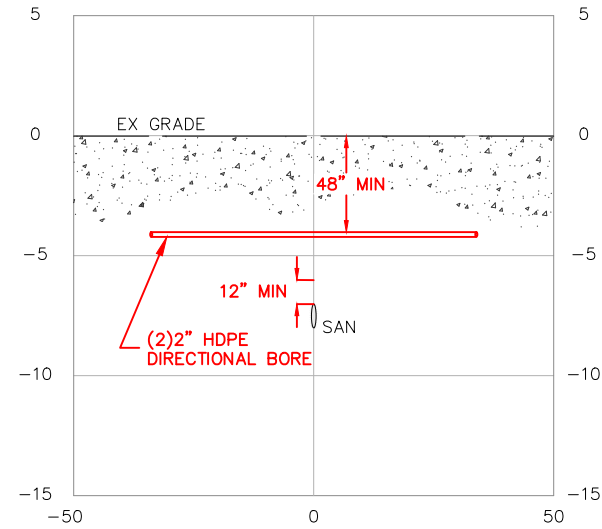

UTILITY CROSSING DETAIL
WASHTENAW AVE
STA 14+84, 14+93
NOT TO SCALE

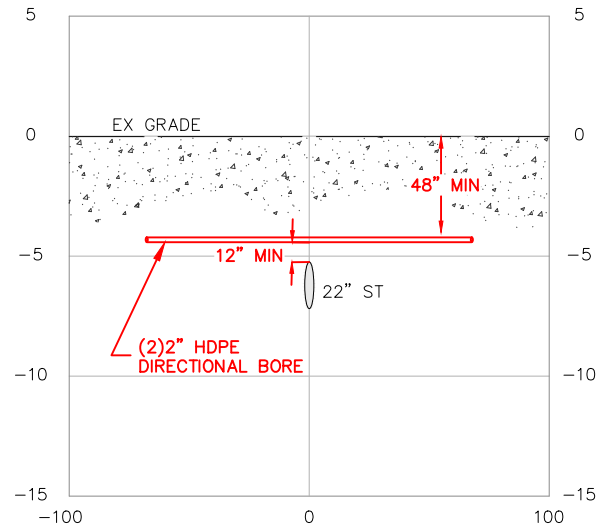

UTILITY CROSSING DETAIL
WASHTENAW AVE
STA 17+77
NOT TO SCALE

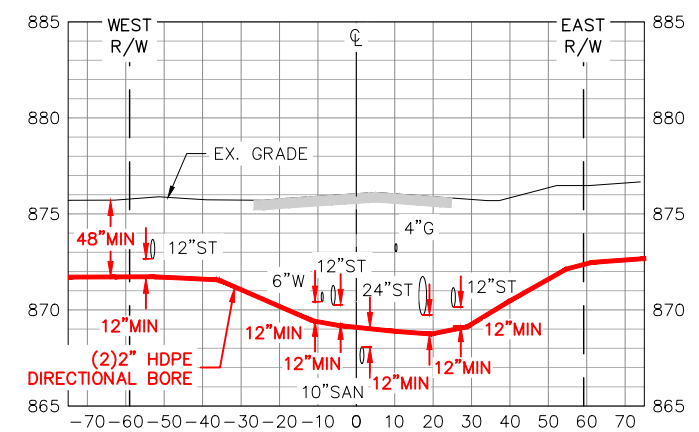

BALDWIN AVE
LOOKING NORTH
1"=50' HORIZONTAL
1"=10' VERTICAL

REVISION		
REV #	DATE	DESCRIPTION
01	06/07/23	CORRECTED DRAIN CROSSING SHT 23
02	07/10/23	ADD BORE PIT DIM SHT 06. DEPTH NOTE ADDED SHTS 18-20
03	07/18/23	REVISED PER CITY OF ANN ARBOR COMMENTS
04	07/25/23	REVISED PER AA FORESTRY COMMENTS
05	08/22/23	REVISED PER CITY OF ANN ARBOR COMMENTS
06	08/28/23	REVISED PER CITY OF ANN ARBOR COMMENTS



THE LOCATIONS OF EXISTING UNDERGROUND UTILITIES ARE SHOWN IN AN APPROXIMATE WAY ONLY AND HAVE NOT BEEN INDEPENDENTLY VERIFIED. THE CONTRACTOR SHALL DETERMINE THE EXACT LOCATION OF ALL EXISTING UTILITIES BEFORE COMMENCING WORK, AND AGREES TO BE FULLY RESPONSIBLE FOR ANY AND ALL DAMAGES WHICH MIGHT BE OCCASIONED BY THE CONTRACTOR'S FAILURE TO EXACTLY LOCATE AND PRESERVE ANY AND ALL UNDERGROUND UTILITIES.

METRO ENGINEERING SOLUTIONS
33900 SCHOOLCRAFT RD
LIVONIA, MICHIGAN 48150
PHONE: 734.483.1427 FAX: 734.483.3431
www.metroes.net

NORTH ROUTE - WEST OF U.S. 23	
MES JOB# 1043-22	DRAWN - KMM
PLOT SCALE = 1" = 50'	CHECKED - JB
PLAN DATE = 05/09/2023	

ANN ARBOR SPARK
CORRIDOR FIBER OPTIC BACKBONE PROJECT
ANN ARBOR
WASHTENAW COUNTY, MI

PERMITS REQUIRED:

<input checked="" type="checkbox"/> CITY OF ANN ARBOR	<input type="checkbox"/> CITY OF YPSILANTI	<input type="checkbox"/> EGLE
<input type="checkbox"/> WASHTENAW COUNTY	<input type="checkbox"/> YPSILANTI TOWNSHIP	<input type="checkbox"/> RR
<input checked="" type="checkbox"/> WASHTENAW COUNTY DRAIN	<input type="checkbox"/> PITTSFIELD TOWNSHIP	<input checked="" type="checkbox"/> MDOT

SHEET INFORMATION

TOTAL SHEETS	SHEET NO.
26	08

K:\2022\1043 JOB FOLDERS\1043-22-0324\DWG\1043-22-0324_DS.dwg; 8/28/2023 11:28 AM;

CITY OF ANN ARBOR
SEC: 33 T: 02S R: 06E

- UTILITY CROSSING/POTHOLE NOTES**
- A** POTHOLE. REMOVE & REPLACE (1) SQFT ASPH ROAD.
 - B** POTHOLE. REMOVE & REPLACE (1) FLAG CONC WALK.
 - C** POTHOLE. REMOVE & REPLACE GREENBELT.
 - D** NO POTHOLE NECESSARY. UTILITY DEPTH TO BE VERIFIED AT NEAREST STRUCTURE.

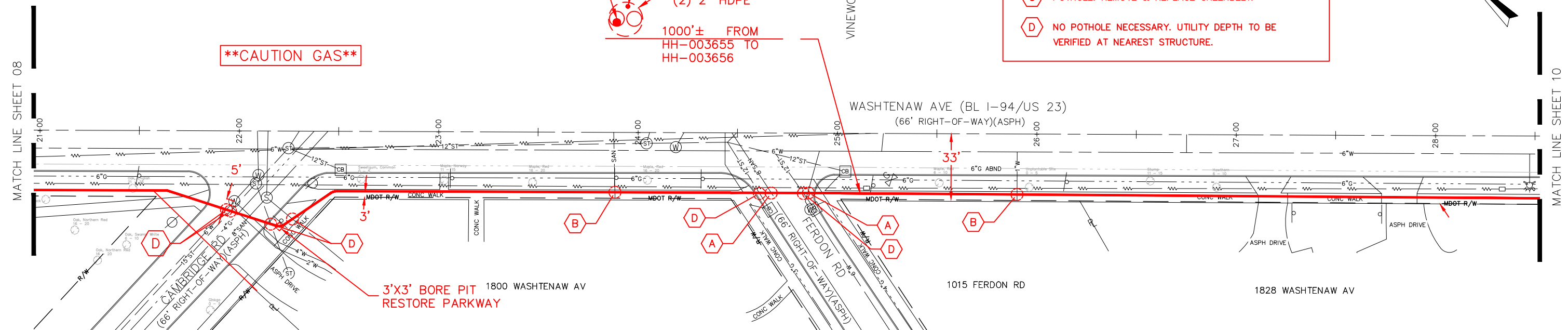
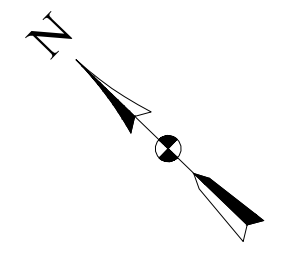

ROAD CROSSING

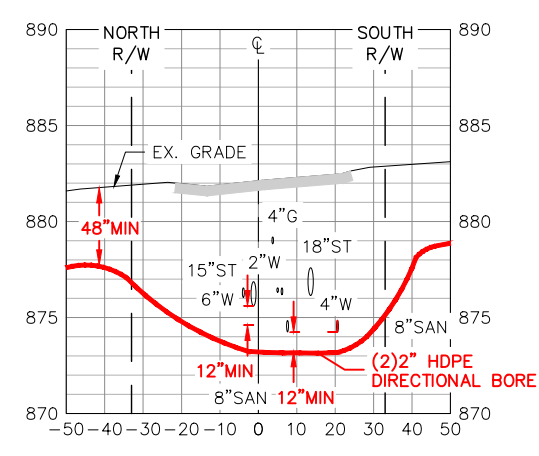

CAMBRIDGE RD
LOOKING EAST
1"=50' HORIZONTAL
1"=10' VERTICAL

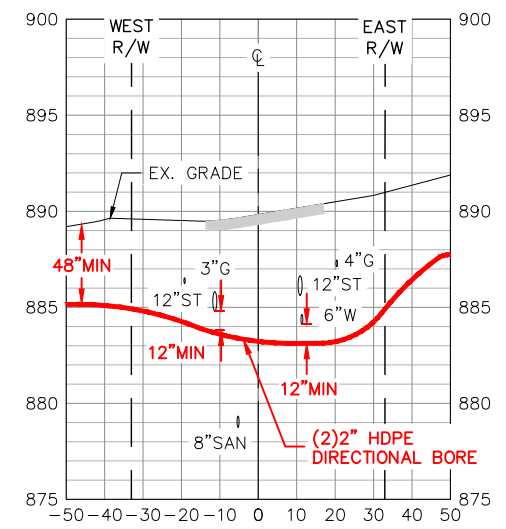

FERDON RD
LOOKING NORTH
1"=50' HORIZONTAL
1"=10' VERTICAL

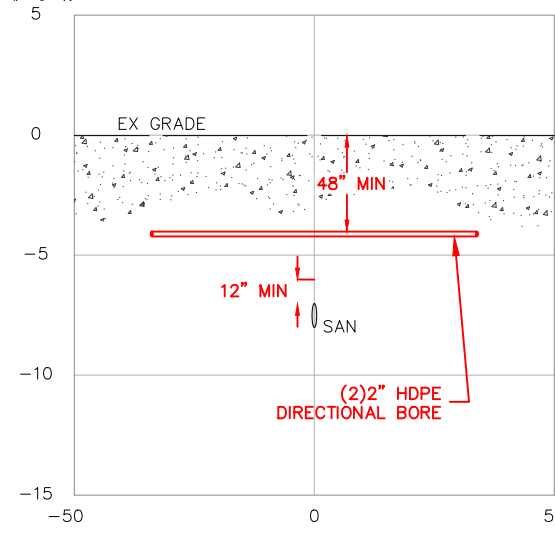

UTILITY CROSSING DETAIL
WASHTENAW AVE
STA 23+87
NOT TO SCALE

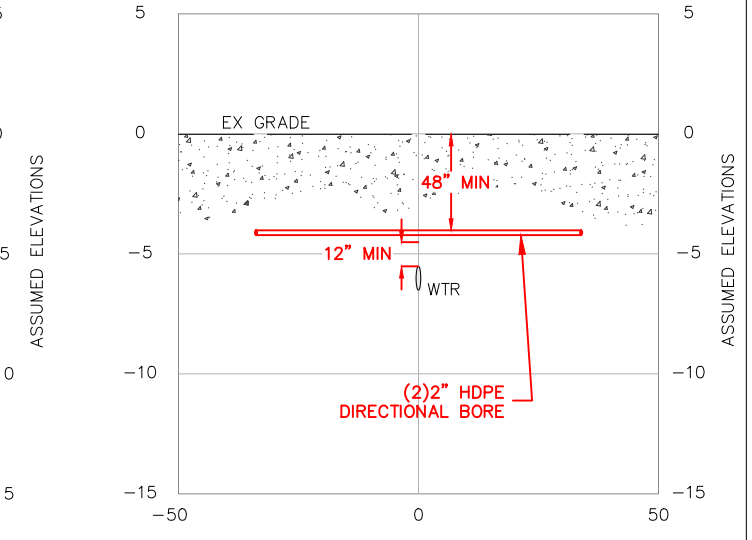

UTILITY CROSSING DETAIL
WASHTENAW AVE
STA 25+90
NOT TO SCALE

REVISION		
REV #	DATE	DESCRIPTION
01	06/07/23	CORRECTED DRAIN CROSSING SHT 23
02	07/10/23	ADD BORE PIT DIM SHT 06. DEPTH NOTE ADDED SHTS 18-20
03	07/18/23	REVISED PER CITY OF ANN ARBOR COMMENTS
04	07/25/23	REVISED PER AA FORESTRY COMMENTS
05	08/22/23	REVISED PER CITY OF ANN ARBOR COMMENTS
06	08/28/23	REVISED PER CITY OF ANN ARBOR COMMENTS



THE LOCATIONS OF EXISTING UNDERGROUND UTILITIES ARE SHOWN IN AN APPROXIMATE WAY ONLY AND HAVE NOT BEEN INDEPENDENTLY VERIFIED. THE CONTRACTOR SHALL DETERMINE THE EXACT LOCATION OF ALL EXISTING UTILITIES BEFORE COMMENCING WORK, AND AGREES TO BE FULLY RESPONSIBLE FOR ANY AND ALL DAMAGES WHICH MIGHT BE OCCASIONED BY THE CONTRACTOR'S FAILURE TO EXACTLY LOCATE AND PRESERVE ANY AND ALL UNDERGROUND UTILITIES.

METRO ENGINEERING SOLUTIONS
33900 SCHOOLCRAFT RD
LIVONIA, MICHIGAN 48150
PHONE: 734.483.1427 FAX: 734.483.3431
www.metroes.net

NORTH ROUTE - WEST OF U.S. 23	
MES JOB# 1043-22	DRAWN - KMM
PLOT SCALE = 1" = 50'	CHECKED - JB
PLAN DATE = 05/09/2023	

ANN ARBOR SPARK
CORRIDOR FIBER OPTIC BACKBONE PROJECT
ANN ARBOR
WASHTENAW COUNTY, MI

PERMITS REQUIRED:

<input checked="" type="checkbox"/> CITY OF ANN ARBOR	<input type="checkbox"/> CITY OF YPSILANTI	<input type="checkbox"/> EGLE
<input type="checkbox"/> WASHTENAW COUNTY	<input type="checkbox"/> YPSILANTI TOWNSHIP	<input type="checkbox"/> RR
<input checked="" type="checkbox"/> WASHTENAW COUNTY DRAIN	<input type="checkbox"/> PITTSFIELD TOWNSHIP	<input checked="" type="checkbox"/> MDOT

SHEET INFORMATION

TOTAL SHEETS	SHEET NO.
26	09

K:\2022\1043 JOB FOLDERS\1043-22-0324\DWG\1043-22-0324_DS.dwg; 8/28/2023 11:28 AM;

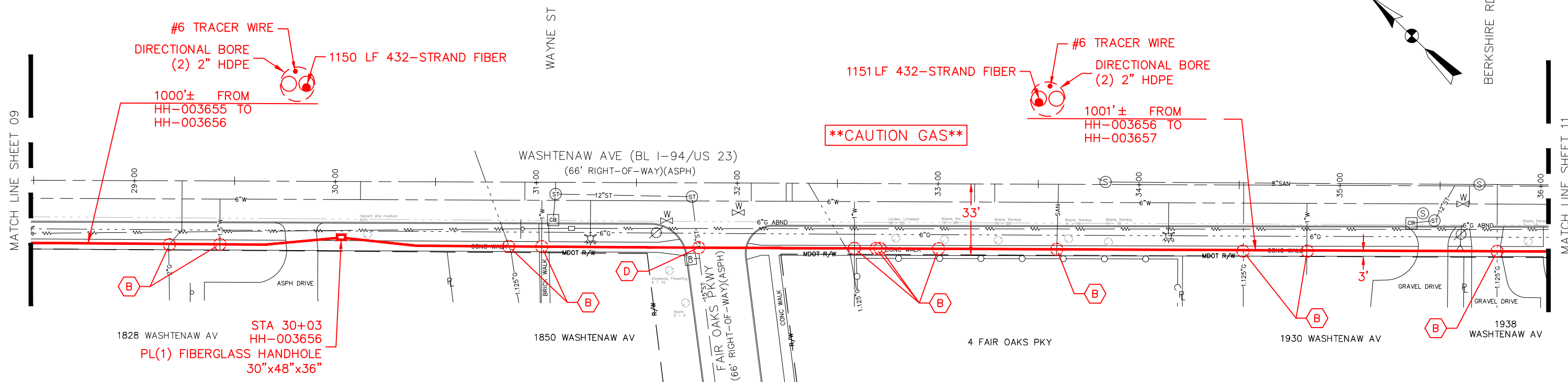
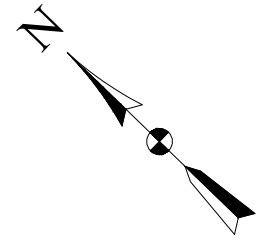

****CAUTION GAS****

- UTILITY CROSSING/POTHOLE NOTES**
- A** POTHOLE. REMOVE & REPLACE (1) SQFT ASPH ROAD.
 - B** POTHOLE. REMOVE & REPLACE (1) FLAG CONC WALK.
 - C** POTHOLE. REMOVE & REPLACE GREENBELT.
 - D** NO POTHOLE NECESSARY. UTILITY DEPTH TO BE VERIFIED AT NEAREST STRUCTURE.

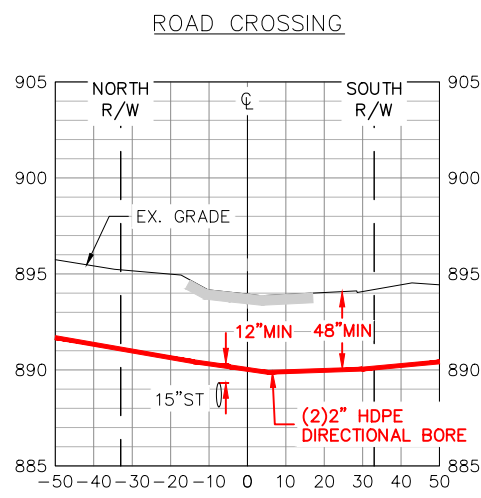

FAIR OAKS PKWY
LOOKING EAST
1"=50' HORIZONTAL
1"=10' VERTICAL

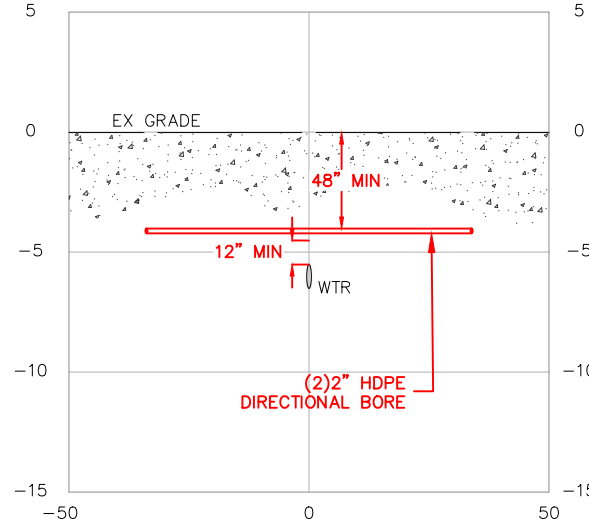

UTILITY CROSSING DETAIL
WASHTENAW AVE
STA 29+43, 31+03, 32+58,
34+83
NOT TO SCALE

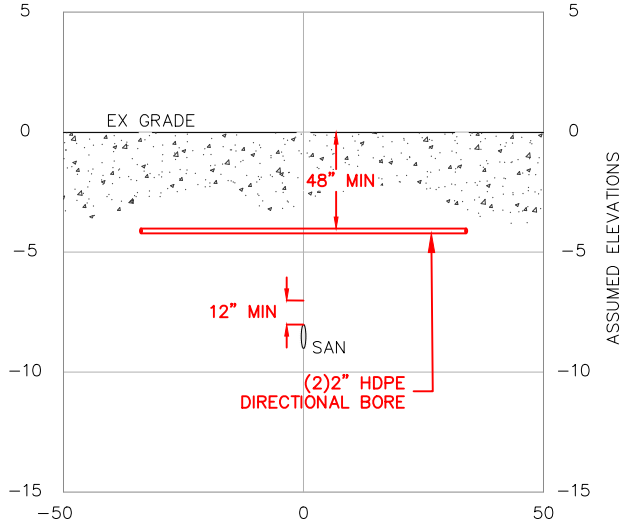

UTILITY CROSSING DETAIL
WASHTENAW AVE
STA 32+69, 32+71, 33+00
NOT TO SCALE

REVISION		
REV #	DATE	DESCRIPTION
01	06/07/23	CORRECTED DRAIN CROSSING SHT 23
02	07/10/23	ADD BORE PIT DIM SHT 06. DEPTH NOTE ADDED SHTS 18-20
03	07/18/23	REVISED PER CITY OF ANN ARBOR COMMENTS
04	07/25/23	REVISED PER AA FORESTRY COMMENTS
05	08/22/23	REVISED PER CITY OF ANN ARBOR COMMENTS
06	08/28/23	REVISED PER CITY OF ANN ARBOR COMMENTS



THE LOCATIONS OF EXISTING UNDERGROUND UTILITIES ARE SHOWN IN AN APPROXIMATE WAY ONLY AND HAVE NOT BEEN INDEPENDENTLY VERIFIED. THE CONTRACTOR SHALL DETERMINE THE EXACT LOCATION OF ALL EXISTING UTILITIES BEFORE COMMENCING WORK, AND AGREES TO BE FULLY RESPONSIBLE FOR ANY AND ALL DAMAGES WHICH MIGHT BE OCCASIONED BY THE CONTRACTOR'S FAILURE TO EXACTLY LOCATE AND PRESERVE ANY AND ALL UNDERGROUND UTILITIES.

METRO ENGINEERING SOLUTIONS
33900 SCHOOLCRAFT RD
LIVONIA, MICHIGAN 48150
PHONE: 734.483.1427 FAX: 734.483.3431
www.metroes.net

NORTH ROUTE - WEST OF U.S. 23	
MES JOB# 1043-22	DRAWN - KMM
PLOT SCALE = 1" = 50'	CHECKED - JB
PLAN DATE = 05/09/2023	

ANN ARBOR SPARK
CORRIDOR FIBER OPTIC BACKBONE PROJECT
ANN ARBOR
WASHTENAW COUNTY, MI

PERMITS REQUIRED:

<input checked="" type="checkbox"/> CITY OF ANN ARBOR	<input type="checkbox"/> CITY OF YPSILANTI	<input type="checkbox"/> EGLE
<input type="checkbox"/> WASHTENAW COUNTY	<input type="checkbox"/> YPSILANTI TOWNSHIP	<input type="checkbox"/> RR
<input checked="" type="checkbox"/> WASHTENAW COUNTY DRAIN	<input type="checkbox"/> PITTSFIELD TOWNSHIP	<input checked="" type="checkbox"/> MDOT

SHEET INFORMATION

TOTAL SHEETS	SHEET NO.
26	10

K:\2022\1043 JOB FOLDERS\1043-22-0324\DWG\1043-22-0324_DS.dwg; 8/28/2023 11:28 AM;

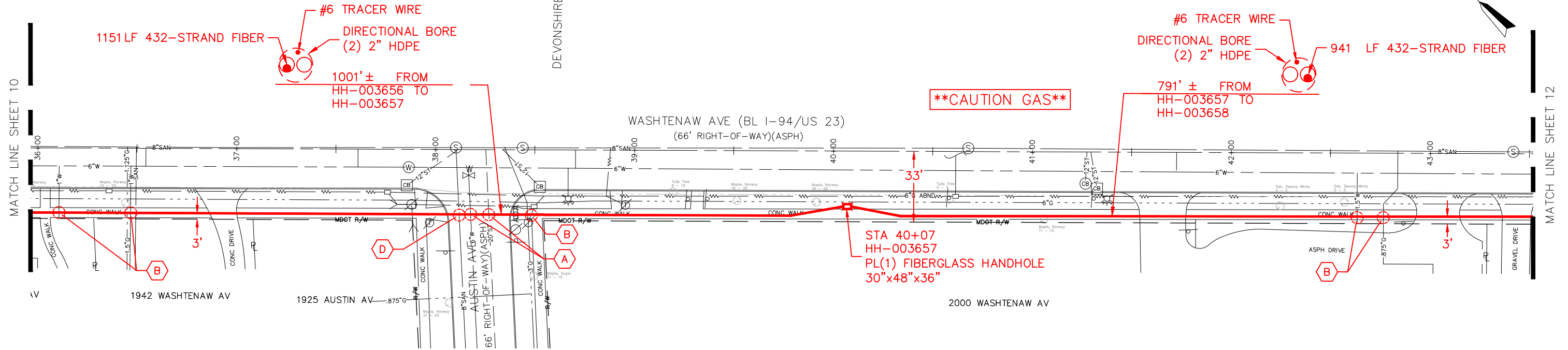
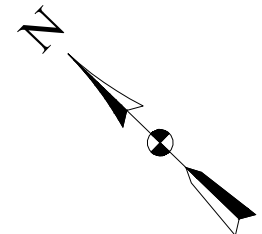

- UTILITY CROSSING/POTHOLE NOTES**
- (A) POT HOLE. REMOVE & REPLACE (1) SQFT ASPH ROAD.
 - (B) POT HOLE. REMOVE & REPLACE (1) FLAG CONC WALK.
 - (C) POT HOLE. REMOVE & REPLACE GREENBELT.
 - (D) NO POT HOLE NECESSARY. UTILITY DEPTH TO BE VERIFIED AT NEAREST STRUCTURE.

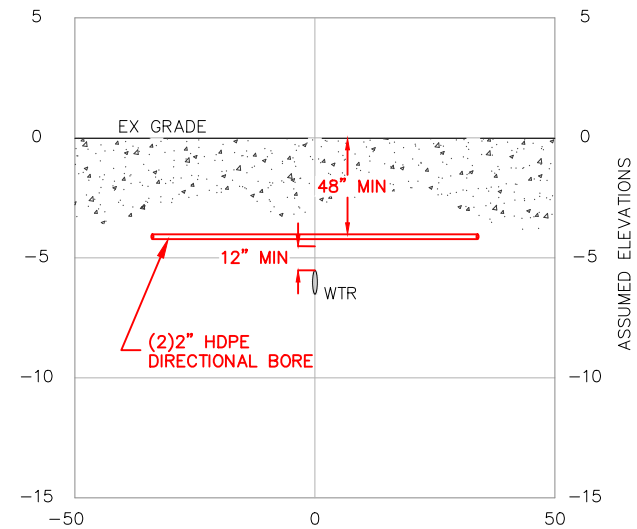
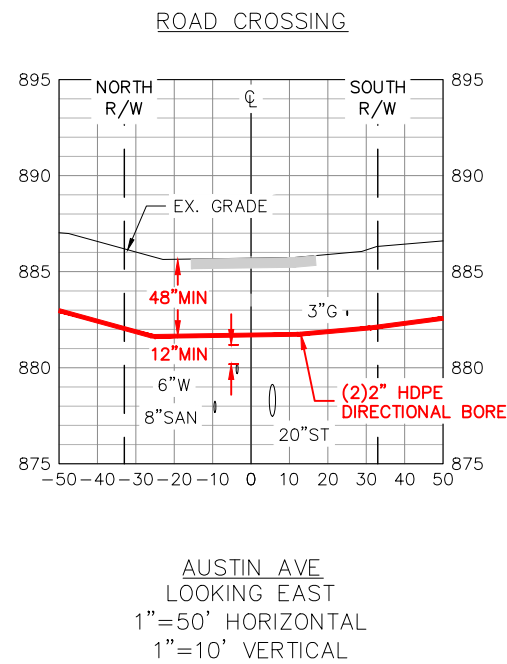

UTILITY CROSSING DETAIL
WASHTENAW AVE
STA 36+11, 36+47. 42+63
NOT TO SCALE

REVISION		DESCRIPTION
REV #	DATE	DESCRIPTION
01	06/07/23	CORRECTED DRAIN CROSSING SHT 23
02	07/10/23	ADD BORE PIT DIM SHT 06. DEPTH NOTE ADDED SHTS 18-20
03	07/18/23	REVISED PER CITY OF ANN ARBOR COMMENTS
04	07/25/23	REVISED PER AA FORESTRY COMMENTS
05	08/22/23	REVISED PER CITY OF ANN ARBOR COMMENTS
06	08/28/23	REVISED PER CITY OF ANN ARBOR COMMENTS



THE LOCATIONS OF EXISTING UNDERGROUND UTILITIES ARE SHOWN IN AN APPROXIMATE WAY ONLY AND HAVE NOT BEEN INDEPENDENTLY VERIFIED. THE CONTRACTOR SHALL DETERMINE THE EXACT LOCATION OF ALL EXISTING UTILITIES BEFORE COMMENCING WORK, AND AGREES TO BE FULLY RESPONSIBLE FOR ANY AND ALL DAMAGES WHICH MIGHT BE OCCASIONED BY THE CONTRACTOR'S FAILURE TO EXACTLY LOCATE AND PRESERVE ANY AND ALL UNDERGROUND UTILITIES.

METRO ENGINEERING SOLUTIONS
33900 SCHOOLCRAFT RD
LIVONIA, MICHIGAN 48150
PHONE: 734.483.1427 FAX: 734.483.3431
www.metroes.net

NORTH ROUTE - WEST OF U.S. 23	
MES JOB# 1043-22	DRAWN - KMM
PLOT SCALE = 1" = 50'	CHECKED - JB
PLAN DATE = 05/09/2023	

ANN ARBOR SPARK
CORRIDOR FIBER OPTIC BACKBONE PROJECT
ANN ARBOR
WASHTENAW COUNTY, MI

PERMITS REQUIRED:

<input checked="" type="checkbox"/> CITY OF ANN ARBOR	<input type="checkbox"/> CITY OF YPSILANTI	<input type="checkbox"/> EGLE
<input type="checkbox"/> WASHTENAW COUNTY	<input type="checkbox"/> YPSILANTI TOWNSHIP	<input type="checkbox"/> RR
<input checked="" type="checkbox"/> WASHTENAW COUNTY DRAIN	<input type="checkbox"/> PITTSFIELD TOWNSHIP	<input checked="" type="checkbox"/> MDOT

SHEET INFORMATION

TOTAL SHEETS	SHEET NO.
26	11

K:\2022\1043 JOB FOLDERS\1043-22-0324\DWG\1043-22-0324_DS.dwg: 8/28/2023 11:28 AM:

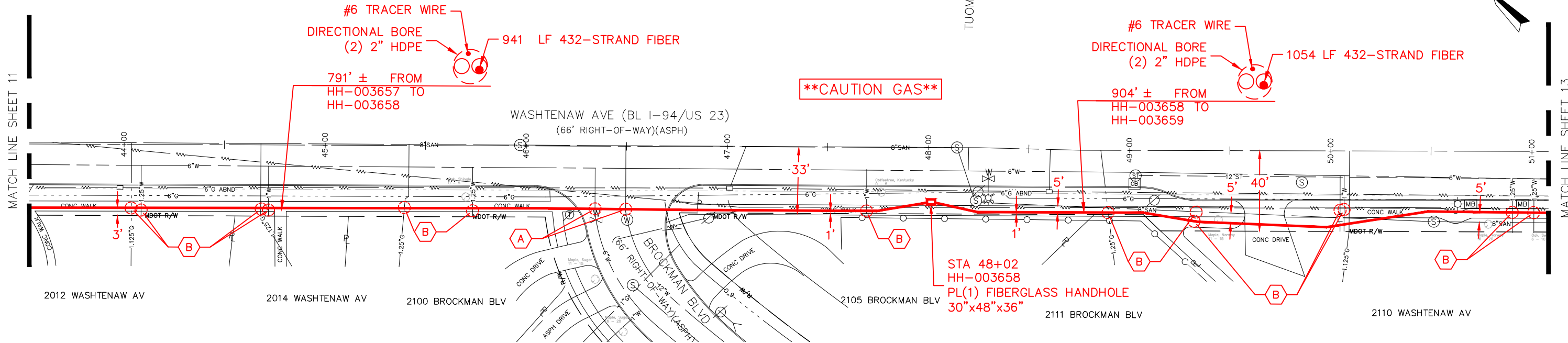
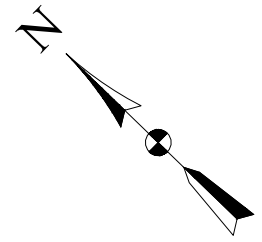

- UTILITY CROSSING/POTHOLE NOTES**
- (A)** POT HOLE. REMOVE & REPLACE (1) SQFT ASPH ROAD.
 - (B)** POT HOLE. REMOVE & REPLACE (1) FLAG CONC WALK.
 - (C)** POT HOLE. REMOVE & REPLACE GREENBELT.
 - (D)** NO POT HOLE NECESSARY. UTILITY DEPTH TO BE VERIFIED AT NEAREST STRUCTURE.

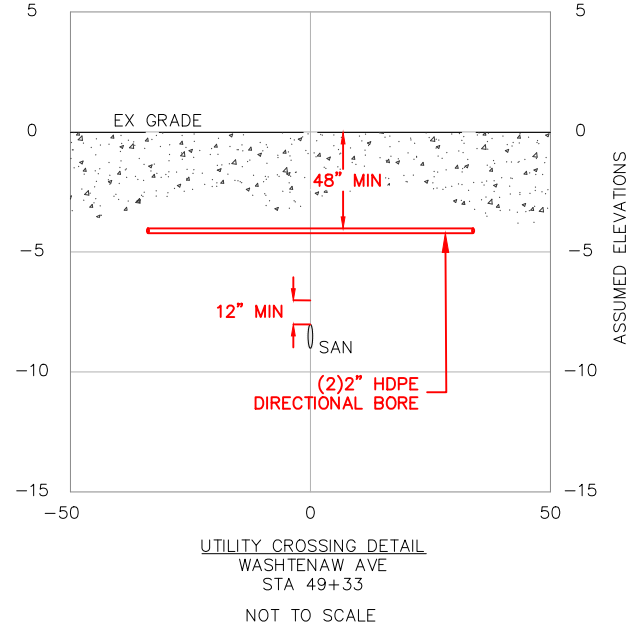
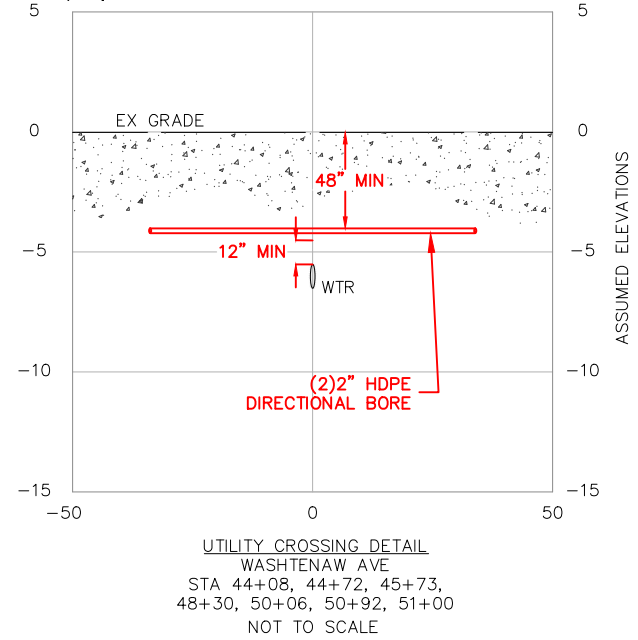
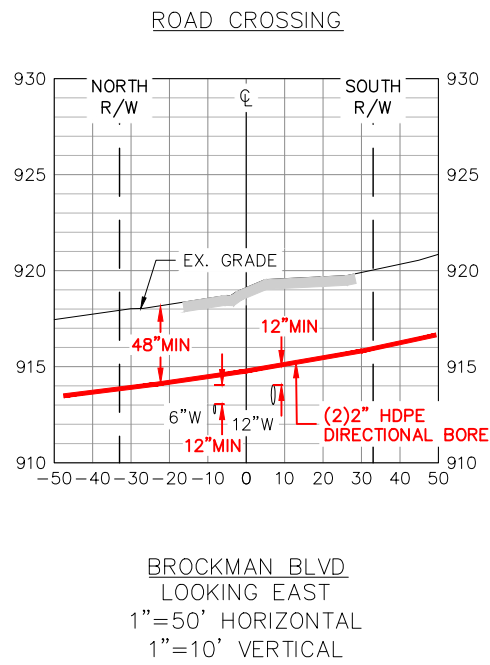

REVISION		
REV #	DATE	DESCRIPTION
01	06/07/23	CORRECTED DRAIN CROSSING SHT 23
02	07/10/23	ADD BORE PIT DIM SHT 06. DEPTH NOTE ADDED SHTS 18-20
03	07/18/23	REVISED PER CITY OF ANN ARBOR COMMENTS
04	07/25/23	REVISED PER AA FORESTRY COMMENTS
05	08/22/23	REVISED PER CITY OF ANN ARBOR COMMENTS
06	08/28/23	REVISED PER CITY OF ANN ARBOR COMMENTS



THE LOCATIONS OF EXISTING UNDERGROUND UTILITIES ARE SHOWN IN AN APPROXIMATE WAY ONLY AND HAVE NOT BEEN INDEPENDENTLY VERIFIED. THE CONTRACTOR SHALL DETERMINE THE EXACT LOCATION OF ALL EXISTING UTILITIES BEFORE COMMENCING WORK, AND AGREES TO BE FULLY RESPONSIBLE FOR ANY AND ALL DAMAGES WHICH MIGHT BE OCCASIONED BY THE CONTRACTOR'S FAILURE TO EXACTLY LOCATE AND PRESERVE ANY AND ALL UNDERGROUND UTILITIES.

METRO ENGINEERING SOLUTIONS
33900 SCHOOLCRAFT RD
LIVONIA, MICHIGAN 48150
PHONE: 734.483.1427 FAX: 734.483.3431
www.metroes.net

NORTH ROUTE - WEST OF U.S. 23	
MES JOB# 1043-22	DRAWN - KMM
PLOT SCALE = 1" = 50'	CHECKED - JB
PLAN DATE = 05/09/2023	

ANN ARBOR SPARK
CORRIDOR FIBER OPTIC BACKBONE PROJECT
ANN ARBOR
WASHTENAW COUNTY, MI

PERMITS REQUIRED:

<input checked="" type="checkbox"/> CITY OF ANN ARBOR	<input type="checkbox"/> CITY OF YPSILANTI	<input type="checkbox"/> EGLE
<input type="checkbox"/> WASHTENAW COUNTY	<input type="checkbox"/> YPSILANTI TOWNSHIP	<input type="checkbox"/> RR
<input checked="" type="checkbox"/> WASHTENAW COUNTY DRAIN	<input type="checkbox"/> PITTSFIELD TOWNSHIP	<input checked="" type="checkbox"/> MDOT

SHEET INFORMATION

TOTAL SHEETS	SHEET NO.
26	12

K:\2022\1043 JOB FOLDERS\1043-22-0324\DWG\1043-22-0324_DS.dwg; 8/28/2023 11:28 AM;

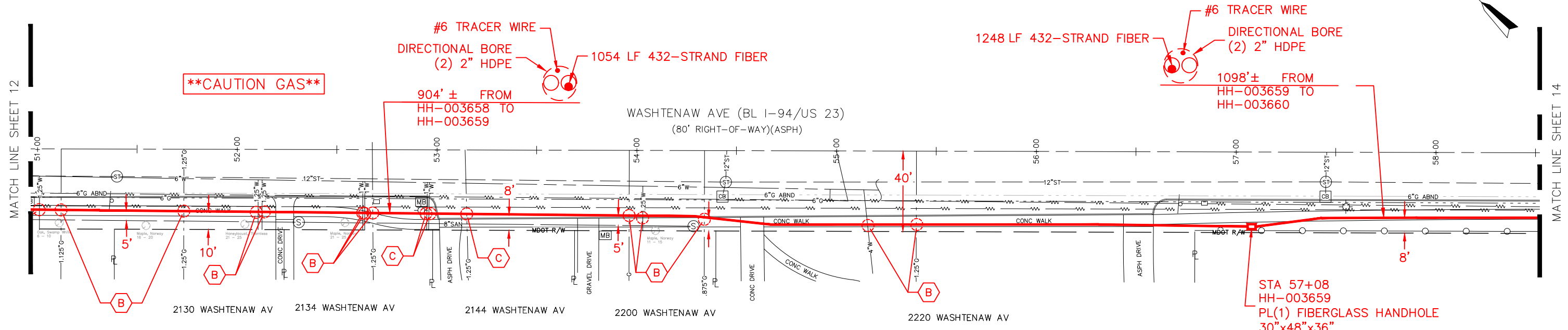
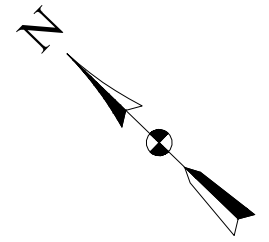

****CAUTION GAS****

- UTILITY CROSSING/POTHOLE NOTES**
- A** POTHOLE. REMOVE & REPLACE (1) SQFT ASPH ROAD.
 - B** POTHOLE. REMOVE & REPLACE (1) FLAG CONC WALK.
 - C** POTHOLE. REMOVE & REPLACE GREENBELT.
 - D** NO POTHOLE NECESSARY. UTILITY DEPTH TO BE VERIFIED AT NEAREST STRUCTURE.

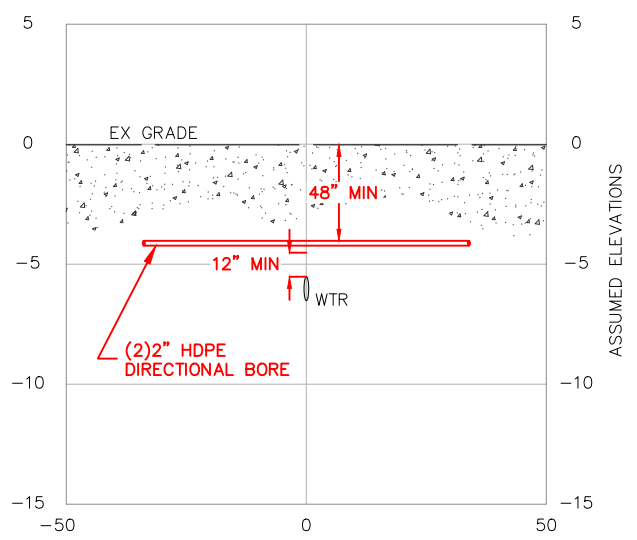

UTILITY CROSSING DETAIL
WASHTENAW AVE
STA 52+12, 52+62, 52+96,
54+04, 55+15
NOT TO SCALE

REVISION		
REV #	DATE	DESCRIPTION
01	06/07/23	CORRECTED DRAIN CROSSING SHT 23
02	07/10/23	ADD BORE PIT DIM SHT 06. DEPTH NOTE ADDED SHTS 18-20
03	07/18/23	REVISED PER CITY OF ANN ARBOR COMMENTS
04	07/25/23	REVISED PER AA FORESTRY COMMENTS
05	08/22/23	REVISED PER CITY OF ANN ARBOR COMMENTS
06	08/28/23	REVISED PER CITY OF ANN ARBOR COMMENTS



THE LOCATIONS OF EXISTING UNDERGROUND UTILITIES ARE SHOWN IN AN APPROXIMATE WAY ONLY AND HAVE NOT BEEN INDEPENDENTLY VERIFIED. THE CONTRACTOR SHALL DETERMINE THE EXACT LOCATION OF ALL EXISTING UTILITIES BEFORE COMMENCING WORK, AND AGREES TO BE FULLY RESPONSIBLE FOR ANY AND ALL DAMAGES WHICH MIGHT BE OCCASIONED BY THE CONTRACTOR'S FAILURE TO EXACTLY LOCATE AND PRESERVE ANY AND ALL UNDERGROUND UTILITIES.

METRO ENGINEERING SOLUTIONS
33900 SCHOOLCRAFT RD
LIVONIA, MICHIGAN 48150
PHONE: 734.483.1427 FAX: 734.483.3431
www.metroes.net

NORTH ROUTE - WEST OF U.S. 23	
MES JOB# 1043-22	DRAWN - KMM
PLOT SCALE = 1" = 50'	CHECKED - JB
PLAN DATE = 05/09/2023	

ANN ARBOR SPARK
CORRIDOR FIBER OPTIC BACKBONE PROJECT
ANN ARBOR
WASHTENAW COUNTY, MI

PERMITS REQUIRED:

<input checked="" type="checkbox"/> CITY OF ANN ARBOR	<input type="checkbox"/> CITY OF YPSILANTI	<input type="checkbox"/> EGLE
<input type="checkbox"/> WASHTENAW COUNTY	<input type="checkbox"/> YPSILANTI TOWNSHIP	<input type="checkbox"/> RR
<input checked="" type="checkbox"/> WASHTENAW COUNTY DRAIN	<input type="checkbox"/> PITTSFIELD TOWNSHIP	<input checked="" type="checkbox"/> MDOT

SHEET INFORMATION

TOTAL SHEETS	SHEET NO.
26	13

K:\2022\1043 JOB FOLDERS\1043-22-0324\DWG\1043-22-0324_DS.dwg; 8/28/2023 11:28 AM;

CITY OF ANN ARBOR
SEC: 34 T: 02S R: 06E

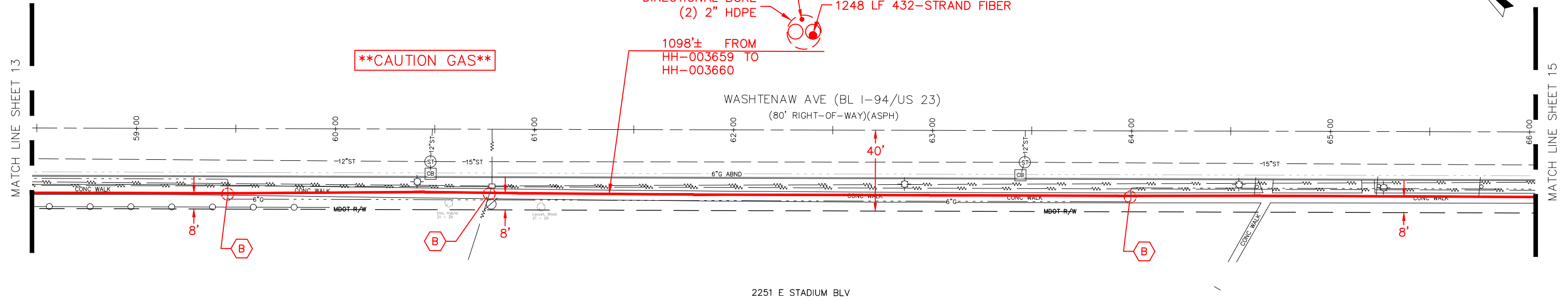
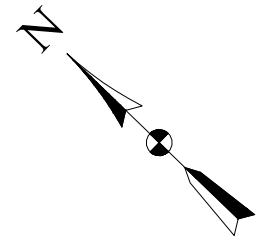

2251 E STADIUM BLV

- UTILITY CROSSING/POTHOLE NOTES**
- A** POTHOLE. REMOVE & REPLACE (1) SQFT ASPH ROAD.
 - B** POTHOLE. REMOVE & REPLACE (1) FLAG CONC WALK.
 - C** POTHOLE. REMOVE & REPLACE GREENBELT.
 - D** NO POTHOLE NECESSARY. UTILITY DEPTH TO BE VERIFIED AT NEAREST STRUCTURE.

REVISION		
REV #	DATE	DESCRIPTION
01	06/07/23	CORRECTED DRAIN CROSSING SHT 23
02	07/10/23	ADD BORE PIT DIM SHT 06. DEPTH NOTE ADDED SHTS 18-20
03	07/18/23	REVISED PER CITY OF ANN ARBOR COMMENTS
04	07/25/23	REVISED PER AA FORESTRY COMMENTS
05	08/22/23	REVISED PER CITY OF ANN ARBOR COMMENTS
06	08/28/23	REVISED PER CITY OF ANN ARBOR COMMENTS



THE LOCATIONS OF EXISTING UNDERGROUND UTILITIES ARE SHOWN IN AN APPROXIMATE WAY ONLY AND HAVE NOT BEEN INDEPENDENTLY VERIFIED. THE CONTRACTOR SHALL DETERMINE THE EXACT LOCATION OF ALL EXISTING UTILITIES BEFORE COMMENCING WORK, AND AGREES TO BE FULLY RESPONSIBLE FOR ANY AND ALL DAMAGES WHICH MIGHT BE OCCASIONED BY THE CONTRACTOR'S FAILURE TO EXACTLY LOCATE AND PRESERVE ANY AND ALL UNDERGROUND UTILITIES.

METRO ENGINEERING SOLUTIONS
33900 SCHOOLCRAFT RD
LIVONIA, MICHIGAN 48150
PHONE: 734.483.1427 FAX: 734.483.3431
www.metroes.net

NORTH ROUTE - WEST OF U.S. 23	
MES JOB# 1043-22	DRAWN - KMM
PLOT SCALE = 1" = 50'	CHECKED - JB
PLAN DATE = 05/09/2023	

ANN ARBOR SPARK
CORRIDOR FIBER OPTIC BACKBONE PROJECT
ANN ARBOR
WASHTENAW COUNTY, MI

PERMITS REQUIRED:

<input checked="" type="checkbox"/> CITY OF ANN ARBOR	<input type="checkbox"/> CITY OF YPSILANTI	<input type="checkbox"/> EGLE
<input type="checkbox"/> WASHTENAW COUNTY	<input type="checkbox"/> YPSILANTI TOWNSHIP	<input type="checkbox"/> RR
<input checked="" type="checkbox"/> WASHTENAW COUNTY DRAIN	<input type="checkbox"/> PITTSFIELD TOWNSHIP	<input checked="" type="checkbox"/> MDOT

SHEET INFORMATION

TOTAL SHEETS	SHEET NO.
26	14

K:\2022\1043 JOB FOLDERS\1043-22-0324\DWG\1043-22-0324_DS.dwg; 8/28/2023 11:28 AM;

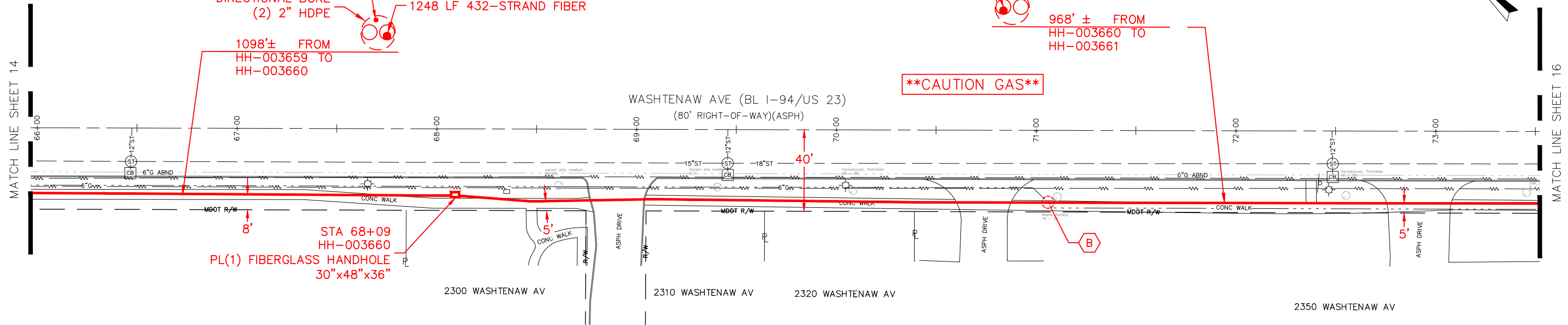
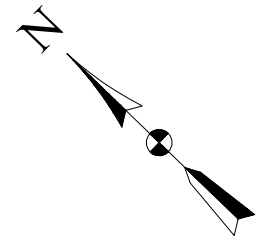

- UTILITY CROSSING/POTHOLE NOTES**
- A** POTHOLE. REMOVE & REPLACE (1) SQFT ASPH ROAD.
 - B** POTHOLE. REMOVE & REPLACE (1) FLAG CONC WALK.
 - C** POTHOLE. REMOVE & REPLACE GREENBELT.
 - D** NO POTHOLE NECESSARY. UTILITY DEPTH TO BE VERIFIED AT NEAREST STRUCTURE.

REVISION		
REV #	DATE	DESCRIPTION
01	06/07/23	CORRECTED DRAIN CROSSING SHT 23
02	07/10/23	ADD BORE PIT DIM SHT 06. DEPTH NOTE ADDED SHTS 18-20
03	07/18/23	REVISED PER CITY OF ANN ARBOR COMMENTS
04	07/25/23	REVISED PER AA FORESTRY COMMENTS
05	08/22/23	REVISED PER CITY OF ANN ARBOR COMMENTS
06	08/28/23	REVISED PER CITY OF ANN ARBOR COMMENTS



THE LOCATIONS OF EXISTING UNDERGROUND UTILITIES ARE SHOWN IN AN APPROXIMATE WAY ONLY AND HAVE NOT BEEN INDEPENDENTLY VERIFIED. THE CONTRACTOR SHALL DETERMINE THE EXACT LOCATION OF ALL EXISTING UTILITIES BEFORE COMMENCING WORK, AND AGREES TO BE FULLY RESPONSIBLE FOR ANY AND ALL DAMAGES WHICH MIGHT BE OCCASIONED BY THE CONTRACTOR'S FAILURE TO EXACTLY LOCATE AND PRESERVE ANY AND ALL UNDERGROUND UTILITIES.

METRO ENGINEERING SOLUTIONS
33900 SCHOOLCRAFT RD
LIVONIA, MICHIGAN 48150
PHONE: 734.483.1427 FAX: 734.483.3431
www.metroes.net

NORTH ROUTE - WEST OF U.S. 23	
MES JOB# 1043-22	DRAWN - KMM
PLOT SCALE = 1" = 50'	CHECKED - JB
PLAN DATE = 05/09/2023	

ANN ARBOR SPARK
CORRIDOR FIBER OPTIC BACKBONE PROJECT
ANN ARBOR
WASHTENAW COUNTY, MI

PERMITS REQUIRED:

<input checked="" type="checkbox"/> CITY OF ANN ARBOR	<input type="checkbox"/> CITY OF YPSILANTI	<input type="checkbox"/> EGLE
<input type="checkbox"/> WASHTENAW COUNTY	<input type="checkbox"/> YPSILANTI TOWNSHIP	<input type="checkbox"/> RR
<input checked="" type="checkbox"/> WASHTENAW COUNTY DRAIN	<input type="checkbox"/> PITTSFIELD TOWNSHIP	<input checked="" type="checkbox"/> MDOT

SHEET INFORMATION

TOTAL SHEETS	SHEET NO.
26	15

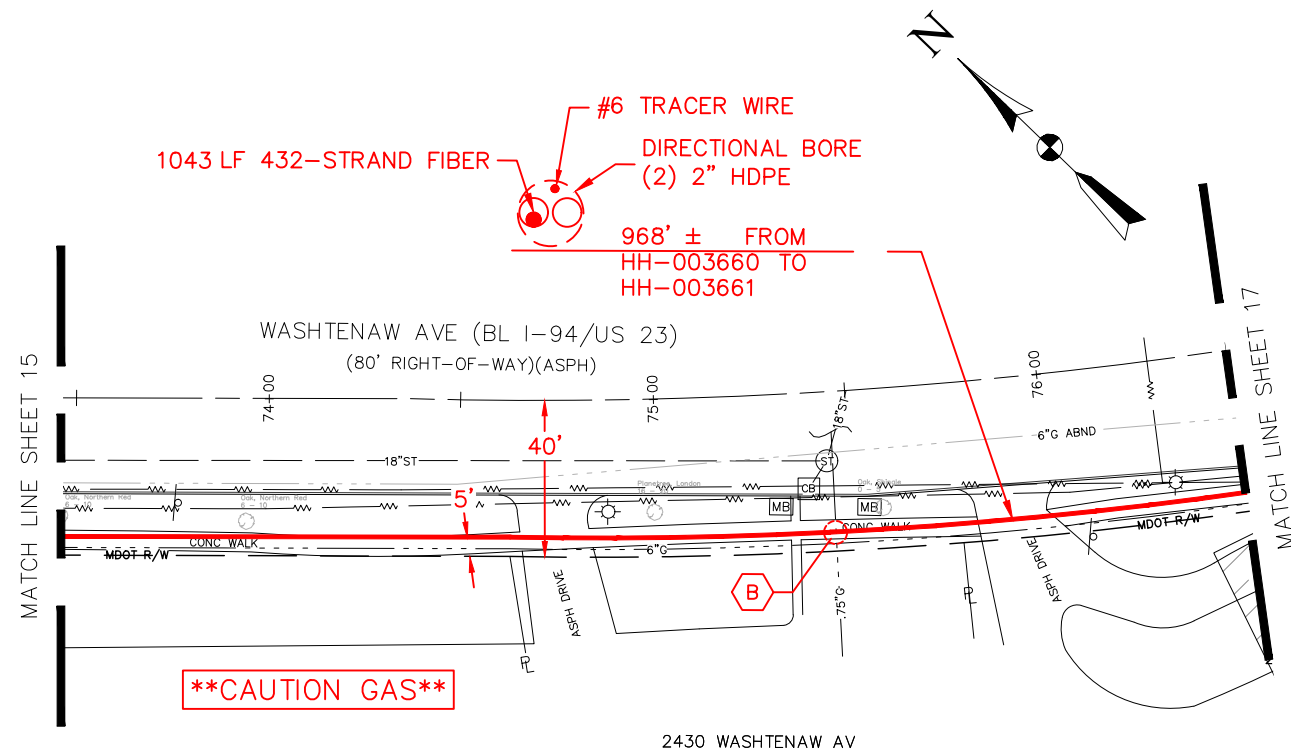

****CAUTION GAS****

UTILITY CROSSING/POTHOLE NOTES

- A** POTHOLE. REMOVE & REPLACE (1) SQFT ASPH ROAD.
- B** POTHOLE. REMOVE & REPLACE (1) FLAG CONC WALK.
- C** POTHOLE. REMOVE & REPLACE GREENBELT.
- D** NO POTHOLE NECESSARY. UTILITY DEPTH TO BE VERIFIED AT NEAREST STRUCTURE.

REVISION		
REV #	DATE	DESCRIPTION
01	06/07/23	CORRECTED DRAIN CROSSING SHT 23
02	07/10/23	ADD BORE PIT DIM SHT 06. DEPTH NOTE ADDED SHTS 18-20
03	07/18/23	REVISED PER CITY OF ANN ARBOR COMMENTS
04	07/25/23	REVISED PER AA FORESTRY COMMENTS
05	08/22/23	REVISED PER CITY OF ANN ARBOR COMMENTS
06	08/28/23	REVISED PER CITY OF ANN ARBOR COMMENTS



Know what's below.
Call before you dig.

THE LOCATIONS OF EXISTING UNDERGROUND UTILITIES ARE SHOWN IN AN APPROXIMATE WAY ONLY AND HAVE NOT BEEN INDEPENDENTLY VERIFIED. THE CONTRACTOR SHALL DETERMINE THE EXACT LOCATION OF ALL EXISTING UTILITIES BEFORE COMMENCING WORK, AND AGREES TO BE FULLY RESPONSIBLE FOR ANY AND ALL DAMAGES WHICH MIGHT BE OCCASIONED BY THE CONTRACTOR'S FAILURE TO EXACTLY LOCATE AND PRESERVE ANY AND ALL UNDERGROUND UTILITIES.

METRO ENGINEERING SOLUTIONS
33900 SCHOOLCRAFT RD
LIVONIA, MICHIGAN 48150
PHONE: 734.483.1427 FAX: 734.483.3431
www.metroes.net

NORTH ROUTE - WEST OF U.S. 23	
MES JOB# 1043-22	DRAWN - KMM
PLOT SCALE = 1" = 50'	CHECKED - JB
PLAN DATE = 05/09/2023	

ANN ARBOR SPARK
CORRIDOR FIBER OPTIC BACKBONE PROJECT
ANN ARBOR
WASHTENAW COUNTY, MI

PERMITS REQUIRED:

<input checked="" type="checkbox"/> CITY OF ANN ARBOR	<input type="checkbox"/> CITY OF YPSILANTI	<input type="checkbox"/> EGLE
<input type="checkbox"/> WASHTENAW COUNTY	<input type="checkbox"/> YPSILANTI TOWNSHIP	<input type="checkbox"/> RR
<input checked="" type="checkbox"/> WASHTENAW COUNTY DRAIN	<input type="checkbox"/> PITTSFIELD TOWNSHIP	<input checked="" type="checkbox"/> MDOT

SHEET INFORMATION

TOTAL SHEETS	SHEET NO.
26	16

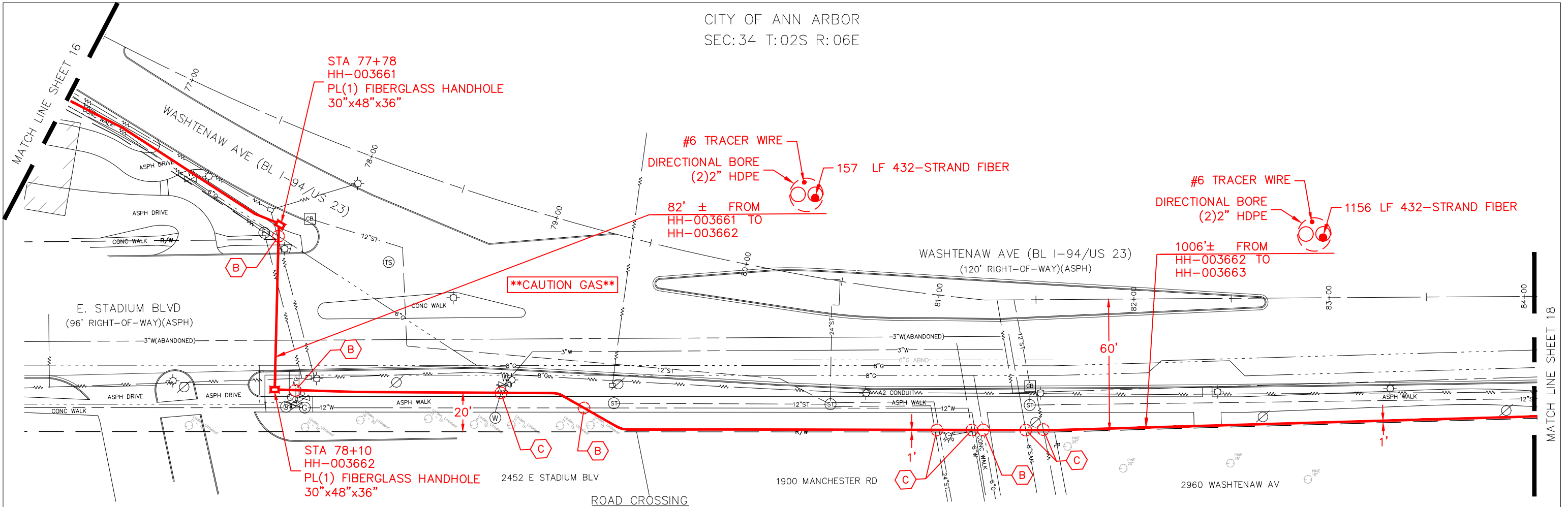

- UTILITY CROSSING/POTHOLE NOTES**
- A** POTHOLE. REMOVE & REPLACE (1) SQFT ASPH ROAD.
 - B** POTHOLE. REMOVE & REPLACE (1) FLAG CONC WALK.
 - C** POTHOLE. REMOVE & REPLACE GREENBELT.
 - D** NO POTHOLE NECESSARY. UTILITY DEPTH TO BE VERIFIED AT NEAREST STRUCTURE.

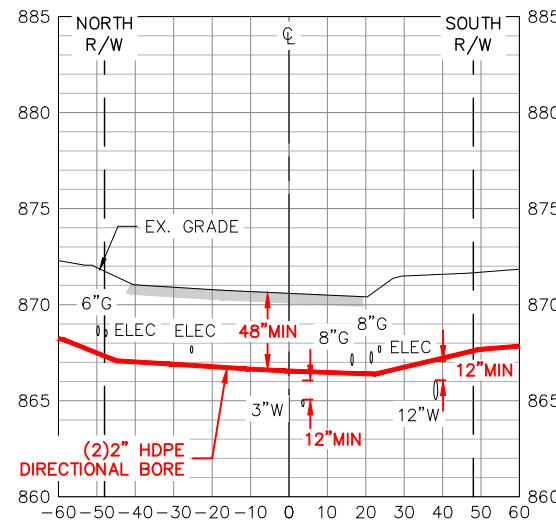

E. STADIUM BLVD
LOOKING EAST
1"=50' HORIZONTAL
1"=10' VERTICAL

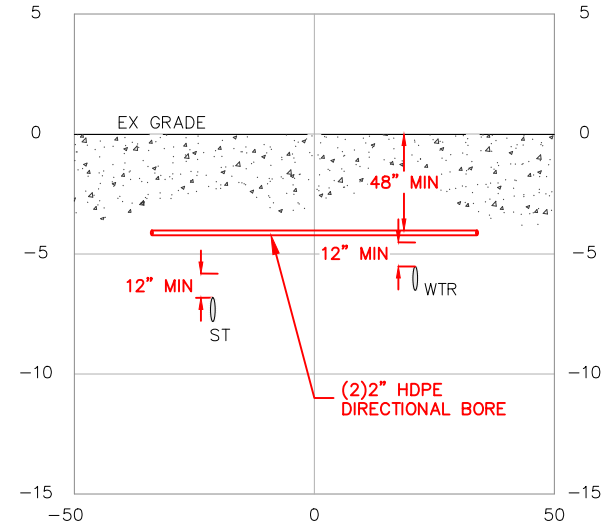

UTILITY CROSSING DETAIL
WASHTENAW AVE
STA 81+17 - 81+29
NOT TO SCALE

INCREASE DEPTH OF BORE TO 72" WHEN NOT UNDER SIDEWALK TO AVOID ROOT ZONE OF TREES

REVISION		
REV #	DATE	DESCRIPTION
01	06/07/23	CORRECTED DRAIN CROSSING SHT 23
02	07/10/23	ADD BORE PIT DIM SHT 06. DEPTH NOTE ADDED SHTS 18-20
03	07/18/23	REVISED PER CITY OF ANN ARBOR COMMENTS
04	07/25/23	REVISED PER AA FORESTRY COMMENTS
05	08/22/23	REVISED PER CITY OF ANN ARBOR COMMENTS
06	08/28/23	REVISED PER CITY OF ANN ARBOR COMMENTS



THE LOCATIONS OF EXISTING UNDERGROUND UTILITIES ARE SHOWN IN AN APPROXIMATE WAY ONLY AND HAVE NOT BEEN INDEPENDENTLY VERIFIED. THE CONTRACTOR SHALL DETERMINE THE EXACT LOCATION OF ALL EXISTING UTILITIES BEFORE COMMENCING WORK, AND AGREES TO BE FULLY RESPONSIBLE FOR ANY AND ALL DAMAGES WHICH MIGHT BE OCCASIONED BY THE CONTRACTOR'S FAILURE TO EXACTLY LOCATE AND PRESERVE ANY AND ALL UNDERGROUND UTILITIES.

METRO ENGINEERING SOLUTIONS
33900 SCHOOLCRAFT RD
LIVONIA, MICHIGAN 48150
PHONE: 734.483.1427 FAX: 734.483.3431
www.metroes.net

NORTH ROUTE - WEST OF U.S. 23	
MES JOB# 1043-22	DRAWN - KMM
PLOT SCALE = 1" = 50'	CHECKED - JB
PLAN DATE = 05/09/2023	

ANN ARBOR SPARK
CORRIDOR FIBER OPTIC BACKBONE PROJECT
ANN ARBOR
WASHTENAW COUNTY, MI

PERMITS REQUIRED:

<input checked="" type="checkbox"/> CITY OF ANN ARBOR	<input type="checkbox"/> CITY OF YPSILANTI	<input type="checkbox"/> EGLE
<input type="checkbox"/> WASHTENAW COUNTY	<input type="checkbox"/> YPSILANTI TOWNSHIP	<input type="checkbox"/> RR
<input checked="" type="checkbox"/> WASHTENAW COUNTY DRAIN	<input type="checkbox"/> PITTSFIELD TOWNSHIP	<input checked="" type="checkbox"/> MDOT

SHEET INFORMATION

TOTAL SHEETS	SHEET NO.
26	17

K:\2022\1043 JOB FOLDERS\1043-22-0325\DWG\1043-22-0325_DS.dwg: 8/28/2023 11:21 AM;

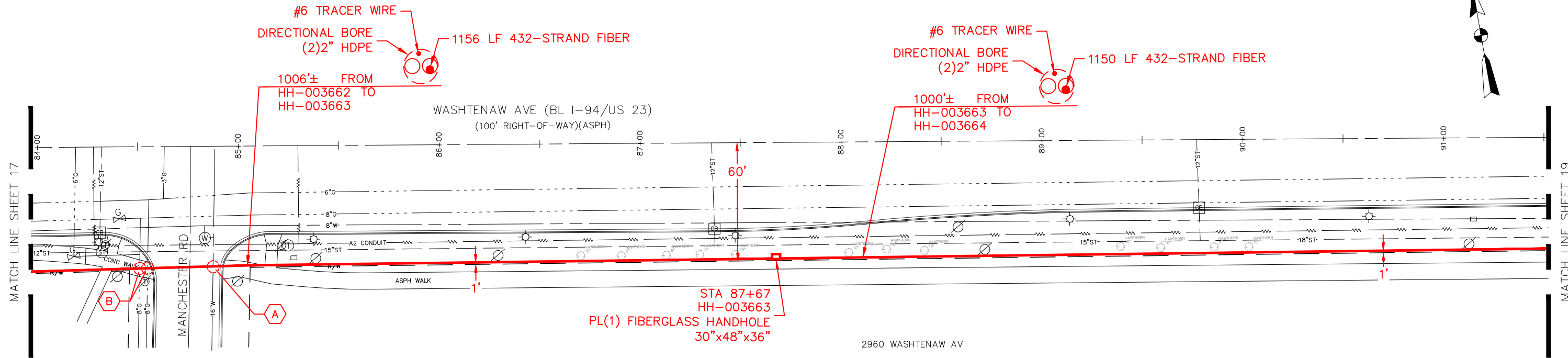
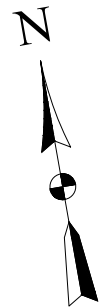

STA 87+67
HH-003663
PL(1) FIBERGLASS HANDHOLE
30"x48"x36"

2960 WASHTENAW AV

ROAD CROSSING

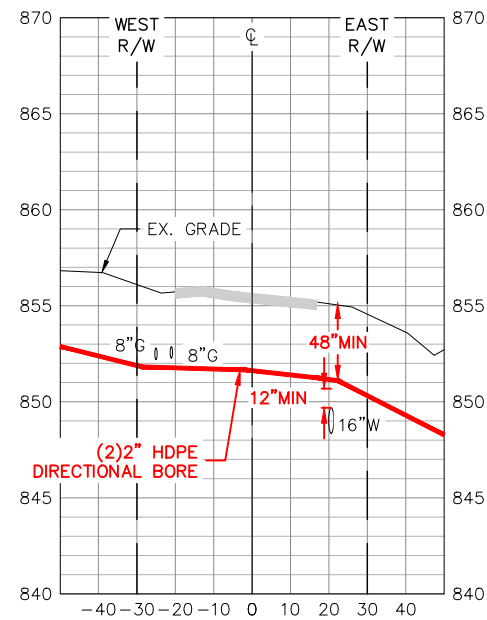

MANCHESTER RD
LOOKING NORTH
1"=50' HORIZONTAL
1"=10' VERTICAL

UTILITY CROSSING/POTHOLE NOTES

- (A) POT HOLE. REMOVE & REPLACE (1) SQFT ASPH ROAD.
- (B) POT HOLE. REMOVE & REPLACE (1) FLAG CONC WALK.
- (C) POT HOLE. REMOVE & REPLACE GREENBELT.
- (D) NO POT HOLE NECESSARY. UTILITY DEPTH TO BE VERIFIED AT NEAREST STRUCTURE.

INCREASE DEPTH OF BORE TO 72" WHEN NOT UNDER SIDEWALK TO AVOID ROOT ZONE OF TREES

REVISION		
REV #	DATE	DESCRIPTION
01	06/07/23	CORRECTED DRAIN CROSSING SHT 23
02	07/10/23	ADD BORE PIT DIM SHT 06. DEPTH NOTE ADDED SHTS 18-20
03	07/18/23	REVISED PER CITY OF ANN ARBOR COMMENTS
04	07/25/23	REVISED PER AA FORESTRY COMMENTS
05	08/22/23	REVISED PER CITY OF ANN ARBOR COMMENTS
06	08/28/23	REVISED PER CITY OF ANN ARBOR COMMENTS



THE LOCATIONS OF EXISTING UNDERGROUND UTILITIES ARE SHOWN IN AN APPROXIMATE WAY ONLY AND HAVE NOT BEEN INDEPENDENTLY VERIFIED. THE CONTRACTOR SHALL DETERMINE THE EXACT LOCATION OF ALL EXISTING UTILITIES BEFORE COMMENCING WORK, AND AGREES TO BE FULLY RESPONSIBLE FOR ANY AND ALL DAMAGES WHICH MIGHT BE OCCASIONED BY THE CONTRACTOR'S FAILURE TO EXACTLY LOCATE AND PRESERVE ANY AND ALL UNDERGROUND UTILITIES.

METRO ENGINEERING SOLUTIONS
33900 SCHOOLCRAFT RD
LIVONIA, MICHIGAN 48150
PHONE: 734.483.1427 FAX: 734.483.3431
www.metroes.net

NORTH ROUTE - WEST OF U.S. 23	
MES JOB# 1043-22	DRAWN - KMM
PLOT SCALE = 1" = 50'	CHECKED - JB
PLAN DATE = 05/09/2023	

ANN ARBOR SPARK
CORRIDOR FIBER OPTIC BACKBONE PROJECT
ANN ARBOR
WASHTENAW COUNTY, MI

PERMITS REQUIRED:		
<input checked="" type="checkbox"/> CITY OF ANN ARBOR	<input type="checkbox"/> CITY OF YPSILANTI	<input type="checkbox"/> EGLE
<input type="checkbox"/> WASHTENAW COUNTY	<input type="checkbox"/> YPSILANTI TOWNSHIP	<input type="checkbox"/> RR
<input checked="" type="checkbox"/> WASHTENAW COUNTY DRAIN	<input type="checkbox"/> PITTSFIELD TOWNSHIP	<input checked="" type="checkbox"/> MDOT

SHEET INFORMATION	
TOTAL SHEETS	SHEET NO.
26	18

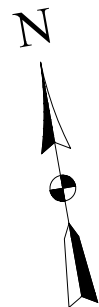

INCREASE DEPTH OF BORE TO 72" WHEN NOT UNDER SIDEWALK TO AVOID ROOT ZONE OF TREES

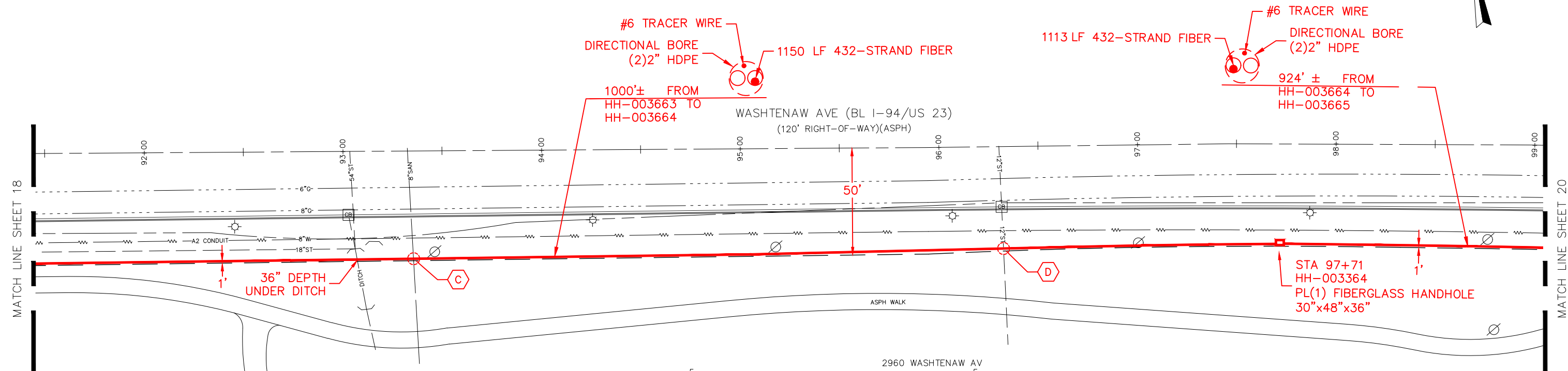

- UTILITY CROSSING/POTHOLE NOTES**
- A** POTHOLE. REMOVE & REPLACE (1) SQFT ASPH ROAD.
 - B** POTHOLE. REMOVE & REPLACE (1) FLAG CONC WALK.
 - C** POTHOLE. REMOVE & REPLACE GREENBELT.
 - D** NO POTHOLE NECESSARY. UTILITY DEPTH TO BE VERIFIED AT NEAREST STRUCTURE.

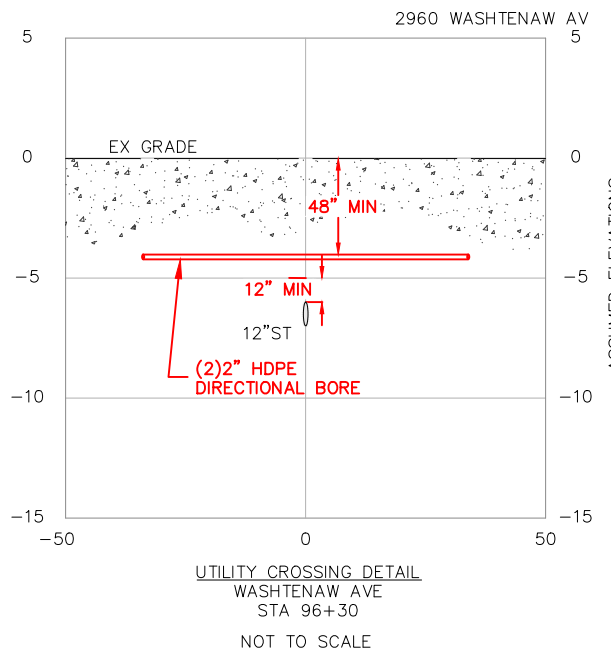

REVISION		
REV #	DATE	DESCRIPTION
01	06/07/23	CORRECTED DRAIN CROSSING SHT 23
02	07/10/23	ADD BORE PIT DIM SHT 06. DEPTH NOTE ADDED SHTS 18-20
03	07/18/23	REVISED PER CITY OF ANN ARBOR COMMENTS
04	07/25/23	REVISED PER AA FORESTRY COMMENTS
05	08/22/23	REVISED PER CITY OF ANN ARBOR COMMENTS
06	08/28/23	REVISED PER CITY OF ANN ARBOR COMMENTS



THE LOCATIONS OF EXISTING UNDERGROUND UTILITIES ARE SHOWN IN AN APPROXIMATE WAY ONLY AND HAVE NOT BEEN INDEPENDENTLY VERIFIED. THE CONTRACTOR SHALL DETERMINE THE EXACT LOCATION OF ALL EXISTING UTILITIES BEFORE COMMENCING WORK, AND AGREES TO BE FULLY RESPONSIBLE FOR ANY AND ALL DAMAGES WHICH MIGHT BE OCCASIONED BY THE CONTRACTOR'S FAILURE TO EXACTLY LOCATE AND PRESERVE ANY AND ALL UNDERGROUND UTILITIES.

METRO ENGINEERING SOLUTIONS
33900 SCHOOLCRAFT RD
LIVONIA, MICHIGAN 48150
PHONE: 734.483.1427 FAX: 734.483.3431
www.metroes.net

NORTH ROUTE - WEST OF U.S. 23	
MES JOB# 1043-22	DRAWN - KMM
PLOT SCALE = 1" = 50'	CHECKED - JB
PLAN DATE = 05/09/2023	

ANN ARBOR SPARK
CORRIDOR FIBER OPTIC BACKBONE PROJECT
ANN ARBOR
WASHTENAW COUNTY, MI

PERMITS REQUIRED:

<input checked="" type="checkbox"/> CITY OF ANN ARBOR	<input type="checkbox"/> CITY OF YPSILANTI	<input type="checkbox"/> EGLE
<input type="checkbox"/> WASHTENAW COUNTY	<input type="checkbox"/> YPSILANTI TOWNSHIP	<input type="checkbox"/> RR
<input checked="" type="checkbox"/> WASHTENAW COUNTY DRAIN	<input type="checkbox"/> PITTSFIELD TOWNSHIP	<input checked="" type="checkbox"/> MDOT

SHEET INFORMATION

TOTAL SHEETS	SHEET NO.
26	19

K:\2022\1043 JOB FOLDERS\1043-22-0325\DWG\1043-22-0325_DS.dwg; 8/28/2023 11:21 AM;

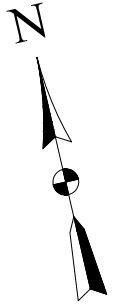

INCREASE DEPTH OF BORE TO 72" WHEN NOT UNDER SIDEWALK TO AVOID ROOT ZONE OF TREES

#6 TRACER WIRE
DIRECTIONAL BORE
(2)2" HDPE
1113 LF 432-STRAND FIBER
924' ± FROM
HH-003664 TO
HH-003665

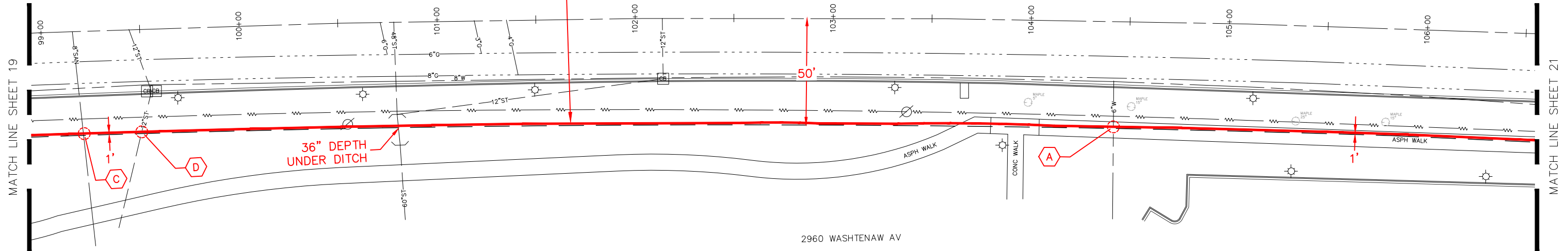

- UTILITY CROSSING/POTHOLE NOTES**
- A POT HOLE. REMOVE & REPLACE (1) SQFT ASPH ROAD.
 - B POT HOLE. REMOVE & REPLACE (1) FLAG CONC WALK.
 - C POT HOLE. REMOVE & REPLACE GREENBELT.
 - D NO POT HOLE NECESSARY. UTILITY DEPTH TO BE VERIFIED AT NEAREST STRUCTURE.

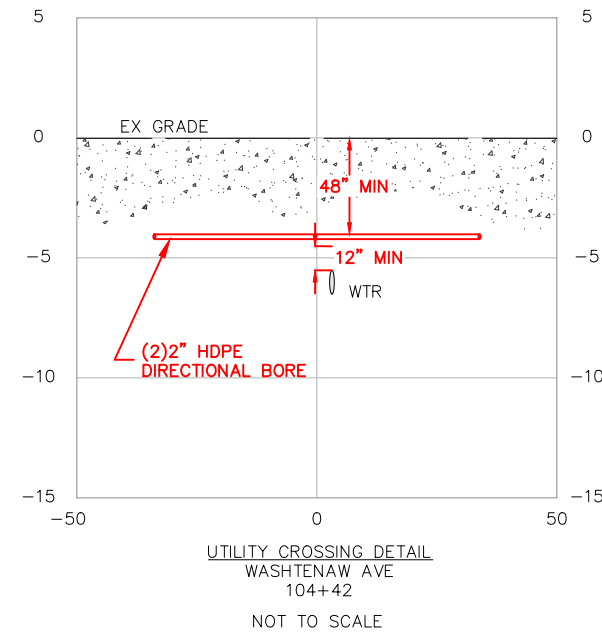
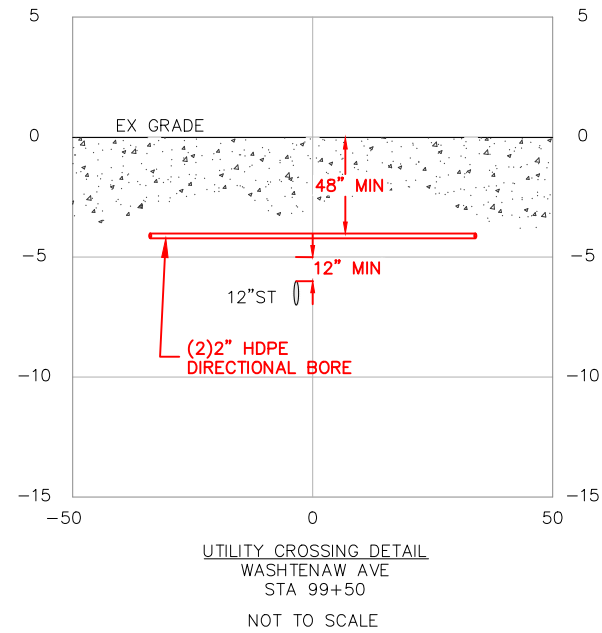

REVISION		
REV #	DATE	DESCRIPTION
01	06/07/23	CORRECTED DRAIN CROSSING SHT 23
02	07/10/23	ADD BORE PIT DIM SHT 06. DEPTH NOTE ADDED SHTS 18-20
03	07/18/23	REVISED PER CITY OF ANN ARBOR COMMENTS
04	07/25/23	REVISED PER AA FORESTRY COMMENTS
05	08/22/23	REVISED PER CITY OF ANN ARBOR COMMENTS
06	08/28/23	REVISED PER CITY OF ANN ARBOR COMMENTS



THE LOCATIONS OF EXISTING UNDERGROUND UTILITIES ARE SHOWN IN AN APPROXIMATE WAY ONLY AND HAVE NOT BEEN INDEPENDENTLY VERIFIED. THE CONTRACTOR SHALL DETERMINE THE EXACT LOCATION OF ALL EXISTING UTILITIES BEFORE COMMENCING WORK, AND AGREES TO BE FULLY RESPONSIBLE FOR ANY AND ALL DAMAGES WHICH MIGHT BE OCCASIONED BY THE CONTRACTOR'S FAILURE TO EXACTLY LOCATE AND PRESERVE ANY AND ALL UNDERGROUND UTILITIES.

METRO ENGINEERING SOLUTIONS
33900 SCHOOLCRAFT RD
LIVONIA, MICHIGAN 48150
PHONE: 734.483.1427 FAX: 734.483.3431
www.metroes.net

NORTH ROUTE - WEST OF U.S. 23	
MES JOB# 1043-22	DRAWN - KMM
PLOT SCALE = 1" = 50'	CHECKED - JB
PLAN DATE = 05/09/2023	

ANN ARBOR SPARK
CORRIDOR FIBER OPTIC BACKBONE PROJECT
ANN ARBOR
WASHTENAW COUNTY, MI

PERMITS REQUIRED:

<input checked="" type="checkbox"/> CITY OF ANN ARBOR	<input type="checkbox"/> CITY OF YPSILANTI	<input type="checkbox"/> EGLE
<input type="checkbox"/> WASHTENAW COUNTY	<input type="checkbox"/> YPSILANTI TOWNSHIP	<input type="checkbox"/> RR
<input checked="" type="checkbox"/> WASHTENAW COUNTY DRAIN	<input type="checkbox"/> PITTSFIELD TOWNSHIP	<input checked="" type="checkbox"/> MDOT

SHEET INFORMATION

TOTAL SHEETS	SHEET NO.
26	20

INCREASE DEPTH OF BORE TO 72" WHEN NOT UNDER SIDEWALK TO AVOID ROOT ZONE OF TREES

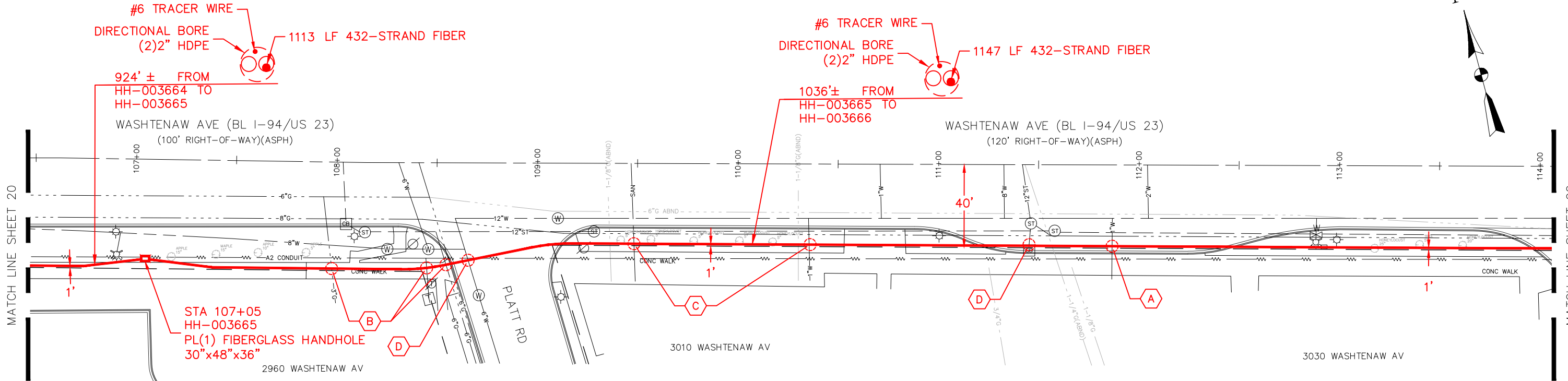
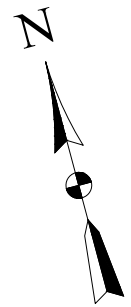

- UTILITY CROSSING/POTHOLE NOTES**
- A** POTHOLE. REMOVE & REPLACE (1) SQFT ASPH ROAD.
 - B** POTHOLE. REMOVE & REPLACE (1) FLAG CONC WALK.
 - C** POTHOLE. REMOVE & REPLACE GREENBELT.
 - D** NO POTHOLE NECESSARY. UTILITY DEPTH TO BE VERIFIED AT NEAREST STRUCTURE.

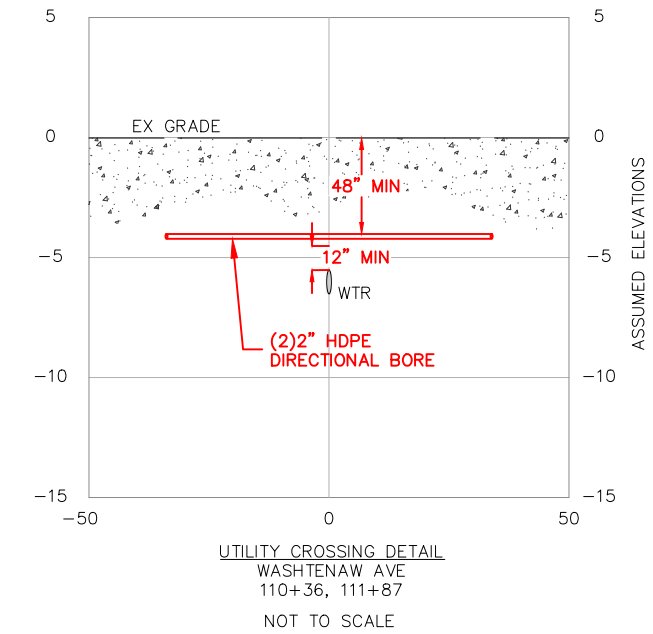
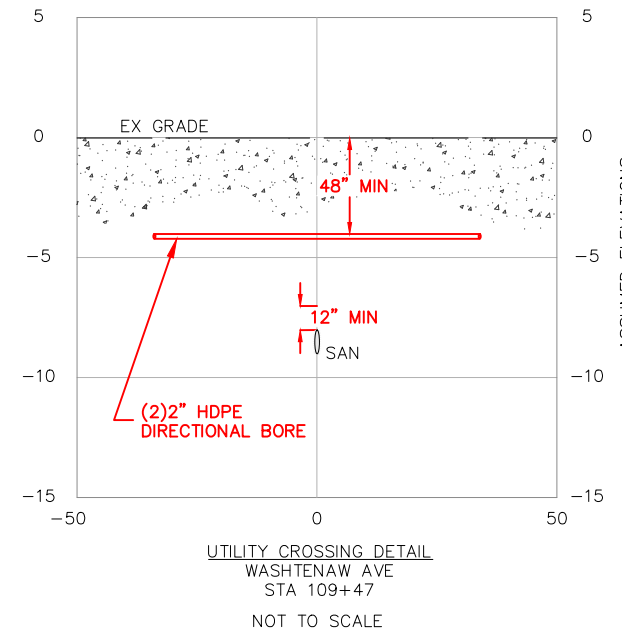
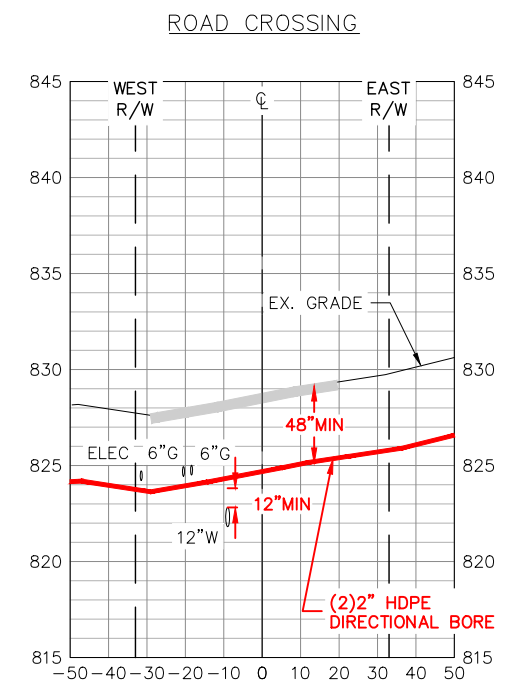

REVISION		
REV #	DATE	DESCRIPTION
01	06/07/23	CORRECTED DRAIN CROSSING SHT 23
02	07/10/23	ADD BORE PIT DIM SHT 06. DEPTH NOTE ADDED SHTS 18-20
03	07/18/23	REVISED PER CITY OF ANN ARBOR COMMENTS
04	07/25/23	REVISED PER AA FORESTRY COMMENTS
05	08/22/23	REVISED PER CITY OF ANN ARBOR COMMENTS
06	08/28/23	REVISED PER CITY OF ANN ARBOR COMMENTS



THE LOCATIONS OF EXISTING UNDERGROUND UTILITIES ARE SHOWN IN AN APPROXIMATE WAY ONLY AND HAVE NOT BEEN INDEPENDENTLY VERIFIED. THE CONTRACTOR SHALL DETERMINE THE EXACT LOCATION OF ALL EXISTING UTILITIES BEFORE COMMENCING WORK, AND AGREES TO BE FULLY RESPONSIBLE FOR ANY AND ALL DAMAGES WHICH MIGHT BE OCCASIONED BY THE CONTRACTOR'S FAILURE TO EXACTLY LOCATE AND PRESERVE ANY AND ALL UNDERGROUND UTILITIES.

METRO ENGINEERING SOLUTIONS
33900 SCHOOLCRAFT RD
LIVONIA, MICHIGAN 48150
PHONE: 734.483.1427 FAX: 734.483.3431
www.metroes.net

NORTH ROUTE - WEST OF U.S. 23	
MES JOB# 1043-22	DRAWN - KMM
PLOT SCALE = 1" = 50'	CHECKED - JB
PLAN DATE = 05/09/2023	

ANN ARBOR SPARK
CORRIDOR FIBER OPTIC BACKBONE PROJECT
ANN ARBOR
WASHTENAW COUNTY, MI

PERMITS REQUIRED:

<input checked="" type="checkbox"/> CITY OF ANN ARBOR	<input type="checkbox"/> CITY OF YPSILANTI	<input type="checkbox"/> EGLE
<input type="checkbox"/> WASHTENAW COUNTY	<input type="checkbox"/> YPSILANTI TOWNSHIP	<input type="checkbox"/> RR
<input checked="" type="checkbox"/> WASHTENAW COUNTY DRAIN	<input type="checkbox"/> PITTSFIELD TOWNSHIP	<input checked="" type="checkbox"/> MDOT

SHEET INFORMATION

TOTAL SHEETS	SHEET NO.
26	21

K:\2022\1043 JOB FOLDERS\1043-22-0325\DWG\1043-22-0325_DS.dwg; 8/28/2023 11:21 AM;

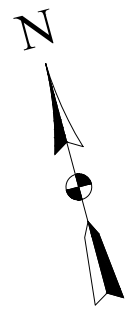

INCREASE DEPTH OF BORE TO 72" WHEN NOT UNDER SIDEWALK TO AVOID ROOT ZONE OF TREES

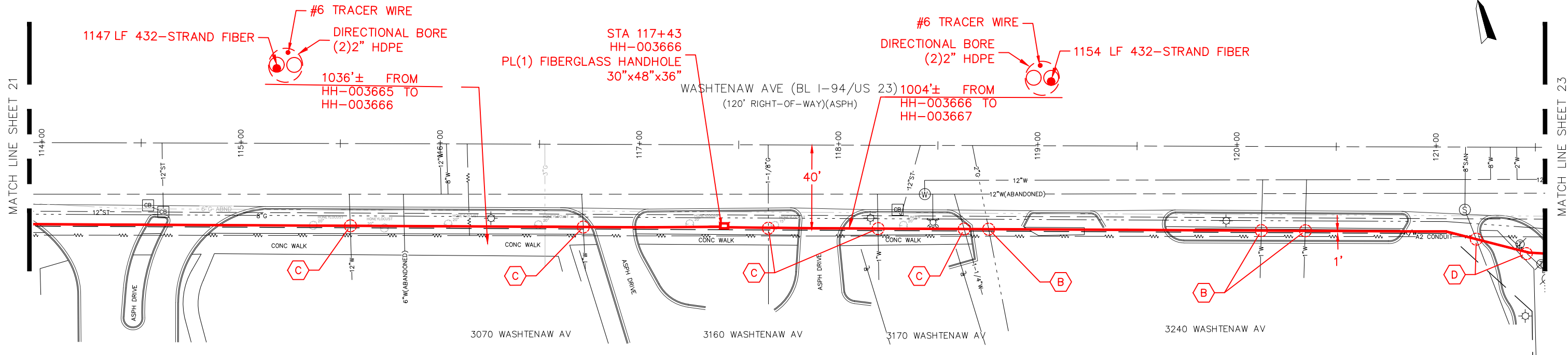

- UTILITY CROSSING/POTHOLE NOTES**
- A POTHOLE. REMOVE & REPLACE (1) SQFT ASPH ROAD.
 - B POTHOLE. REMOVE & REPLACE (1) FLAG CONC WALK.
 - C POTHOLE. REMOVE & REPLACE GREENBELT.
 - D NO POTHOLE NECESSARY. UTILITY DEPTH TO BE VERIFIED AT NEAREST STRUCTURE.

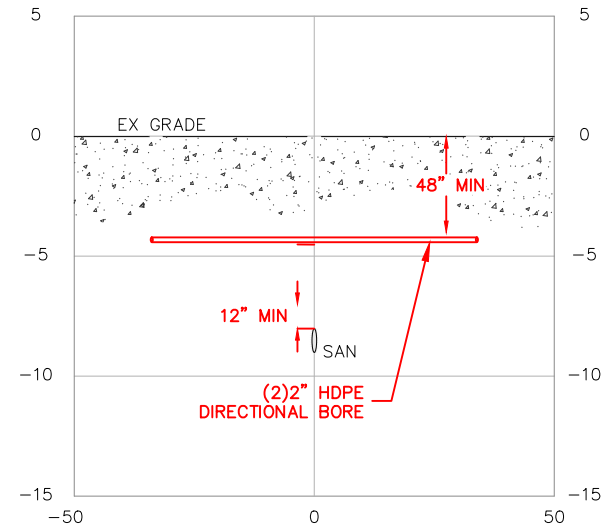
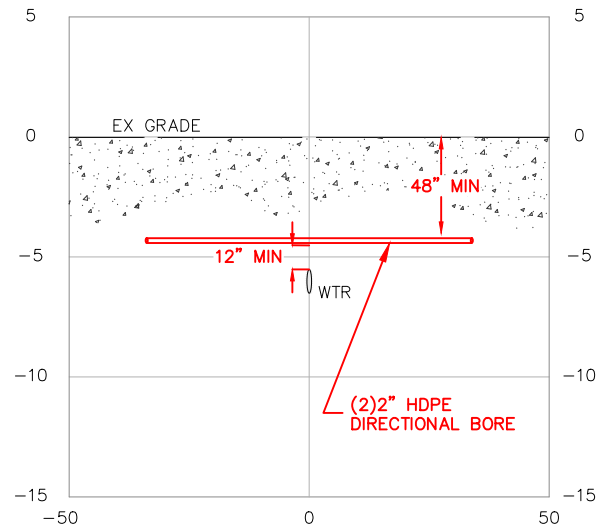

REVISION		
REV #	DATE	DESCRIPTION
01	06/07/23	CORRECTED DRAIN CROSSING SHT 23
02	07/10/23	ADD BORE PIT DIM SHT 06. DEPTH NOTE ADDED SHTS 18-20
03	07/18/23	REVISED PER CITY OF ANN ARBOR COMMENTS
04	07/25/23	REVISED PER AA FORESTRY COMMENTS
05	08/22/23	REVISED PER CITY OF ANN ARBOR COMMENTS
06	08/28/23	REVISED PER CITY OF ANN ARBOR COMMENTS



THE LOCATIONS OF EXISTING UNDERGROUND UTILITIES ARE SHOWN IN AN APPROXIMATE WAY ONLY AND HAVE NOT BEEN INDEPENDENTLY VERIFIED. THE CONTRACTOR SHALL DETERMINE THE EXACT LOCATION OF ALL EXISTING UTILITIES BEFORE COMMENCING WORK, AND AGREES TO BE FULLY RESPONSIBLE FOR ANY AND ALL DAMAGES WHICH MIGHT BE OCCASIONED BY THE CONTRACTOR'S FAILURE TO EXACTLY LOCATE AND PRESERVE ANY AND ALL UNDERGROUND UTILITIES.

METRO ENGINEERING SOLUTIONS
33900 SCHOOLCRAFT RD
LIVONIA, MICHIGAN 48150
PHONE: 734.483.1427 FAX: 734.483.3431
www.metroes.net

NORTH ROUTE - WEST OF U.S. 23	
MES JOB# 1043-22	DRAWN - KMM
PLOT SCALE = 1" = 50'	CHECKED - JB
PLAN DATE = 05/09/2023	

ANN ARBOR SPARK
CORRIDOR FIBER OPTIC BACKBONE PROJECT
ANN ARBOR
WASHTENAW COUNTY, MI

PERMITS REQUIRED:

<input checked="" type="checkbox"/> CITY OF ANN ARBOR	<input type="checkbox"/> CITY OF YPSILANTI	<input type="checkbox"/> EGLE
<input type="checkbox"/> WASHTENAW COUNTY	<input type="checkbox"/> YPSILANTI TOWNSHIP	<input type="checkbox"/> RR
<input checked="" type="checkbox"/> WASHTENAW COUNTY DRAIN	<input type="checkbox"/> PITTSFIELD TOWNSHIP	<input checked="" type="checkbox"/> MDOT

SHEET INFORMATION

TOTAL SHEETS	SHEET NO.
26	22

K:\2022\1043 JOB FOLDERS\1043-22-0325\DWG\1043-22-0325_DS.dwg; 8/28/2023 11:21 AM;

CITY OF ANN ARBOR
SEC:02 T:03S R:06E

WASHTENAW AVE (BL I-94/US 23)
(280' RIGHT-OF-WAY)(ASPH)

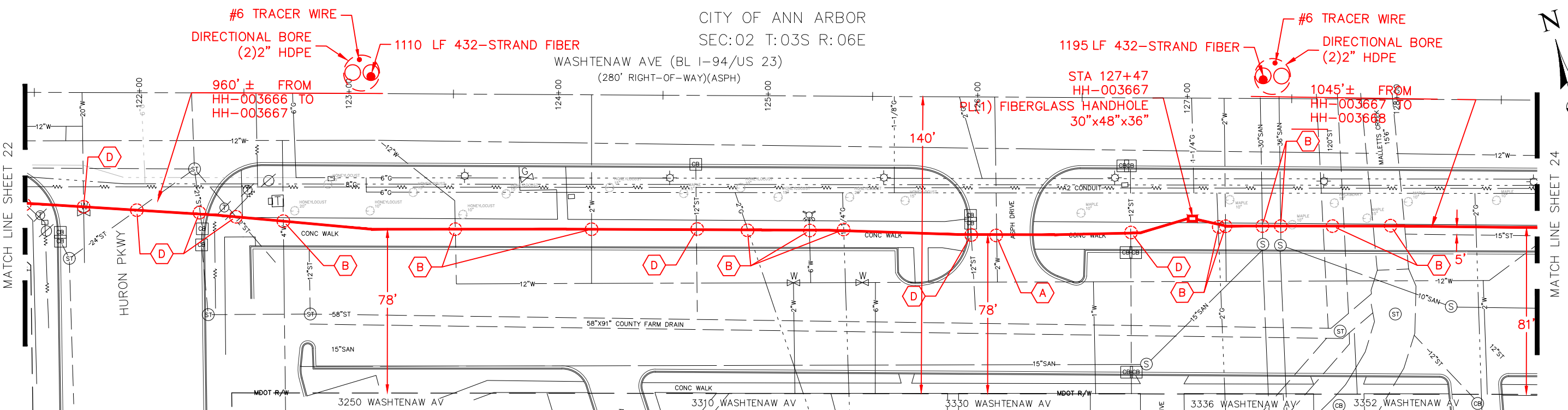

ROAD CROSSING

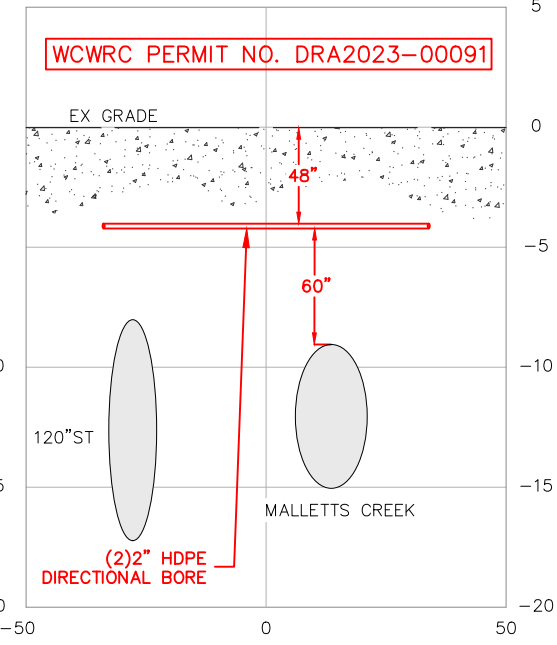
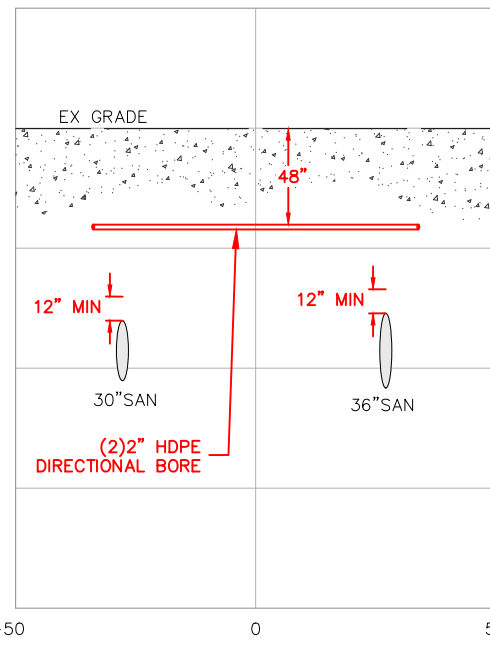
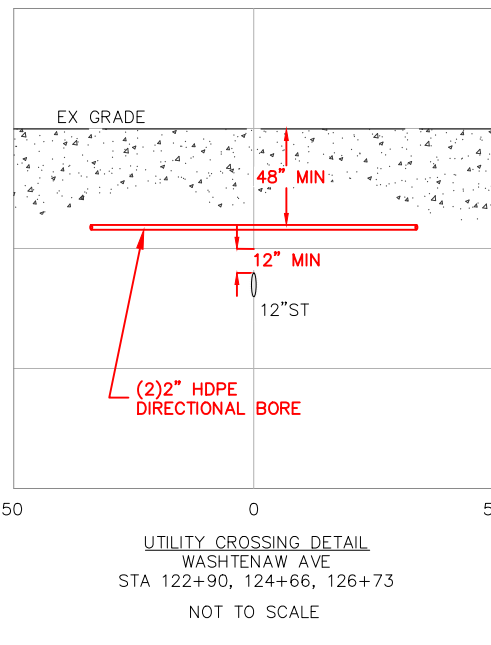
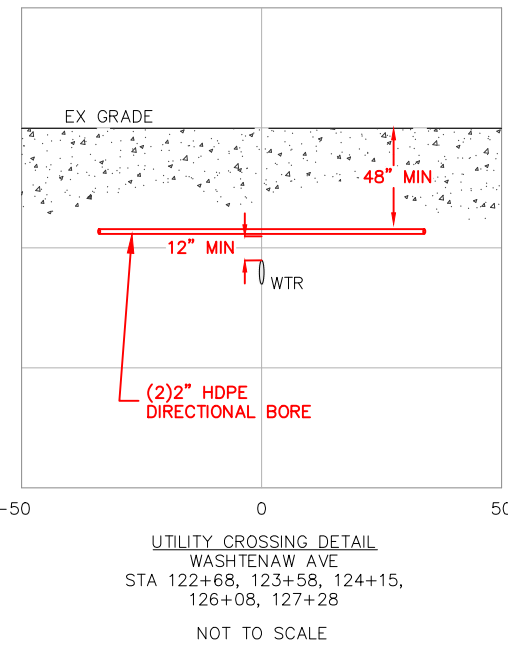
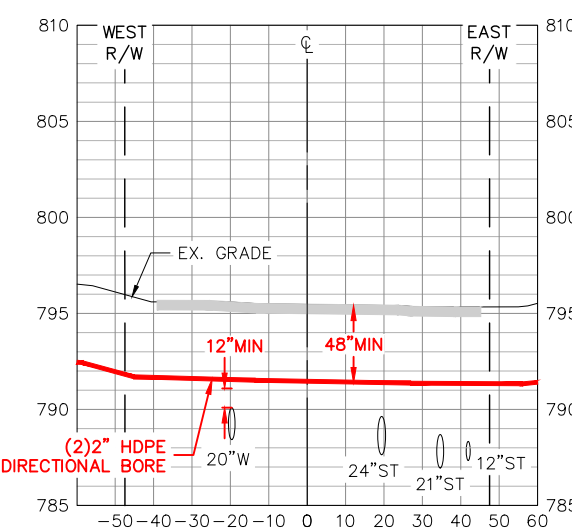

WCWRC PERMIT NO. DRA2023-00091

HURON PKWY (1)
LOOKING NORTH
1"=50' HORIZONTAL
1"=10' VERTICAL

THE LOCATIONS OF EXISTING UNDERGROUND UTILITIES ARE SHOWN IN AN APPROXIMATE WAY ONLY AND HAVE NOT BEEN INDEPENDENTLY VERIFIED. THE CONTRACTOR SHALL DETERMINE THE EXACT LOCATION OF ALL EXISTING UTILITIES BEFORE COMMENCING WORK, AND AGREES TO BE FULLY RESPONSIBLE FOR ANY AND ALL DAMAGES WHICH MIGHT BE OCCASIONED BY THE CONTRACTOR'S FAILURE TO EXACTLY LOCATE AND PRESERVE ANY AND ALL UNDERGROUND UTILITIES.

- UTILITY CROSSING/POTHOLE NOTES**
- (A)** POTHOLE. REMOVE & REPLACE (1) SQFT ASPH ROAD.
 - (B)** POTHOLE. REMOVE & REPLACE (1) FLAG CONC WALK.
 - (C)** POTHOLE. REMOVE & REPLACE GREENBELT.
 - (D)** NO POTHOLE NECESSARY. UTILITY DEPTH TO BE VERIFIED AT NEAREST STRUCTURE.

REV #	DATE	DESCRIPTION
01	06/07/23	CORRECTED DRAIN CROSSING SHT 23
02	07/10/23	ADD BORE PIT DIM SHT 06. DEPTH NOTE ADDED SHTS 18-20
03	07/18/23	REVISED PER CITY OF ANN ARBOR COMMENTS
04	07/25/23	REVISED PER AA FORESTRY COMMENTS
05	08/22/23	REVISED PER CITY OF ANN ARBOR COMMENTS
06	08/28/23	REVISED PER CITY OF ANN ARBOR COMMENTS



METRO ENGINEERING SOLUTIONS
33900 SCHOOLCRAFT RD
LIVONIA, MICHIGAN 48150
PHONE: 734.483.1427 FAX: 734.483.3431
www.metroes.net

NORTH ROUTE - WEST OF U.S. 23	
MES JOB# 1043-22	DRAWN - KMM
PLOT SCALE = 1" = 50'	CHECKED - JB
PLAN DATE = 05/09/2023	

ANN ARBOR SPARK
CORRIDOR FIBER OPTIC BACKBONE PROJECT
ANN ARBOR
WASHTENAW COUNTY, MI

PERMITS REQUIRED:

<input checked="" type="checkbox"/> CITY OF ANN ARBOR	<input type="checkbox"/> CITY OF YPSILANTI	<input type="checkbox"/> EGLE
<input type="checkbox"/> WASHTENAW COUNTY	<input type="checkbox"/> YPSILANTI TOWNSHIP	<input type="checkbox"/> RR
<input checked="" type="checkbox"/> WASHTENAW COUNTY DRAIN	<input type="checkbox"/> PITTSFIELD TOWNSHIP	<input checked="" type="checkbox"/> MDOT

SHEET INFORMATION

TOTAL SHEETS	SHEET NO.
26	23

K:\2022\1043 JOB FOLDERS\1043-22-0325\DWG\1043-22-0325_DS.dwg; 8/28/2023 11:21 AM;

CITY OF ANN ARBOR
SEC:02 T:03S R:06E

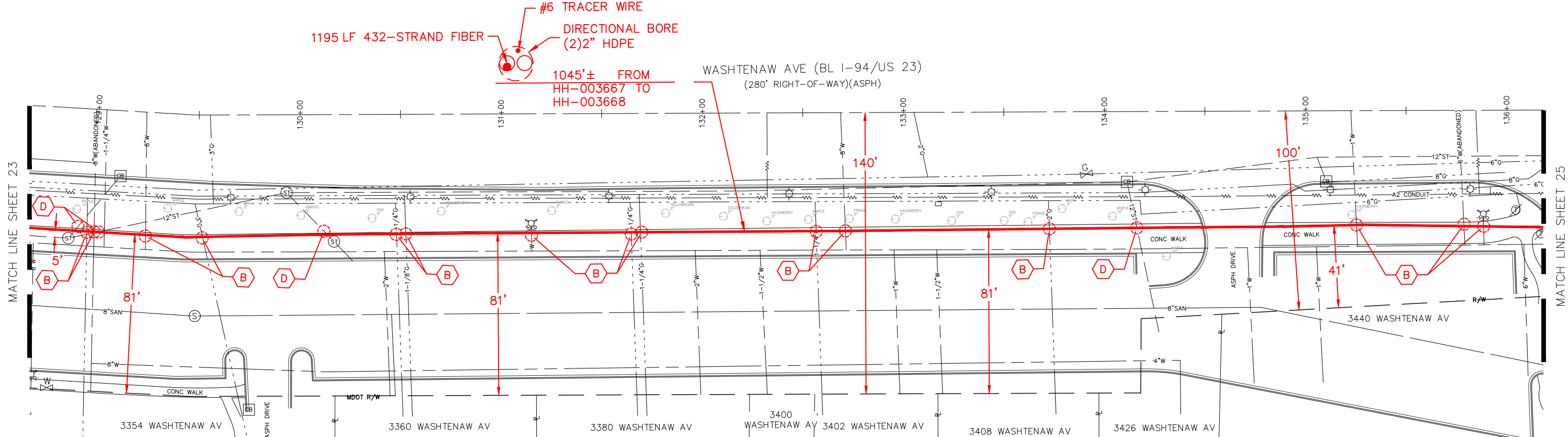

- UTILITY CROSSING/POTHOLE NOTES**
- (A)** POT HOLE. REMOVE & REPLACE (1) SQFT ASPH ROAD.
 - (B)** POT HOLE. REMOVE & REPLACE (1) FLAG CONC WALK.
 - (C)** POT HOLE. REMOVE & REPLACE GREENBELT.
 - (D)** NO POT HOLE NECESSARY. UTILITY DEPTH TO BE VERIFIED AT NEAREST STRUCTURE.

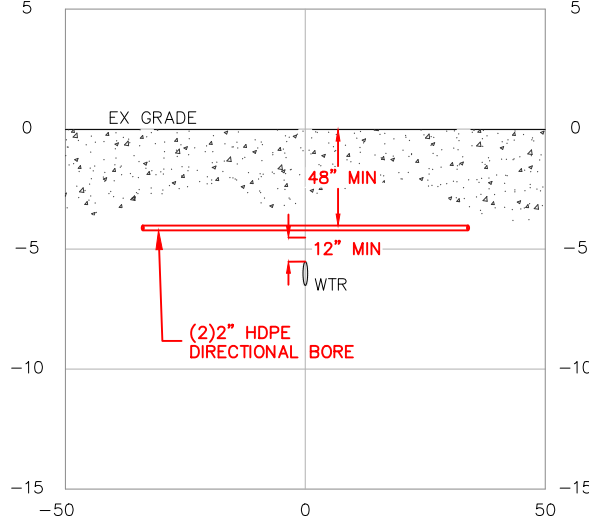

UTILITY CROSSING DETAIL
WASHTENAW AVE
STA 128+99, 129+03, 129+23,
132+69, 135+22, 135+76
NOT TO SCALE

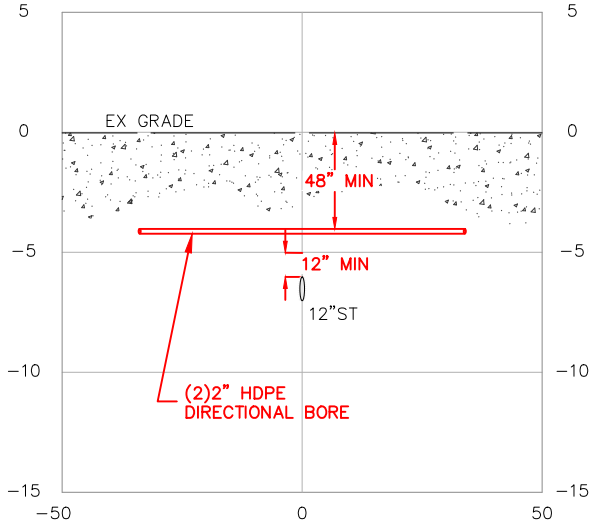

UTILITY CROSSING DETAIL
WASHTENAW AVE
STA 128+93, 130+11, 134+15
NOT TO SCALE

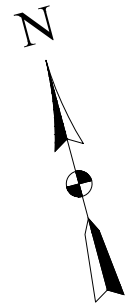

THE LOCATIONS OF EXISTING UNDERGROUND UTILITIES ARE SHOWN IN AN APPROXIMATE WAY ONLY AND HAVE NOT BEEN INDEPENDENTLY VERIFIED. THE CONTRACTOR SHALL DETERMINE THE EXACT LOCATION OF ALL EXISTING UTILITIES BEFORE COMMENCING WORK, AND AGREES TO BE FULLY RESPONSIBLE FOR ANY AND ALL DAMAGES WHICH MIGHT BE OCCASIONED BY THE CONTRACTOR'S FAILURE TO EXACTLY LOCATE AND PRESERVE ANY AND ALL UNDERGROUND UTILITIES.

METRO ENGINEERING SOLUTIONS
33900 SCHOOLCRAFT RD
LIVONIA, MICHIGAN 48150
PHONE: 734.483.1427 FAX: 734.483.3431
www.metroes.net

NORTH ROUTE - WEST OF U.S. 23	
MES JOB# 1043-22	DRAWN - KMM
PLOT SCALE = 1" = 50'	CHECKED - JB
PLAN DATE = 05/09/2023	

ANN ARBOR SPARK
CORRIDOR FIBER OPTIC BACKBONE PROJECT
ANN ARBOR
WASHTENAW COUNTY, MI

PERMITS REQUIRED:

<input checked="" type="checkbox"/> CITY OF ANN ARBOR	<input type="checkbox"/> CITY OF YPSILANTI	<input type="checkbox"/> EGLE
<input type="checkbox"/> WASHTENAW COUNTY	<input type="checkbox"/> YPSILANTI TOWNSHIP	<input type="checkbox"/> RR
<input checked="" type="checkbox"/> WASHTENAW COUNTY DRAIN	<input type="checkbox"/> PITTSFIELD TOWNSHIP	<input checked="" type="checkbox"/> MDOT

SHEET INFORMATION

TOTAL SHEETS	SHEET NO.
26	24

REVISION		
REV #	DATE	DESCRIPTION
01	06/07/23	CORRECTED DRAIN CROSSING SHT 23
02	07/10/23	ADD BORE PIT DIM SHT 06. DEPTH NOTE ADDED SHTS 18-20
03	07/18/23	REVISED PER CITY OF ANN ARBOR COMMENTS
04	07/25/23	REVISED PER AA FORESTRY COMMENTS
05	08/22/23	REVISED PER CITY OF ANN ARBOR COMMENTS
06	08/28/23	REVISED PER CITY OF ANN ARBOR COMMENTS

K:\2022\1043 JOB FOLDERS\1043-22-0325\DWG\1043-22-0325_DS.dwg; 8/28/2023 11:21 AM;

WASHTENAW AVE (BL I-94/US 23)
(120' RIGHT-OF-WAY)(ASPH)

INCREASE DEPTH OF BORE TO 72" WHEN NOT UNDER SIDEWALK TO AVOID ROOT ZONE OF TREES

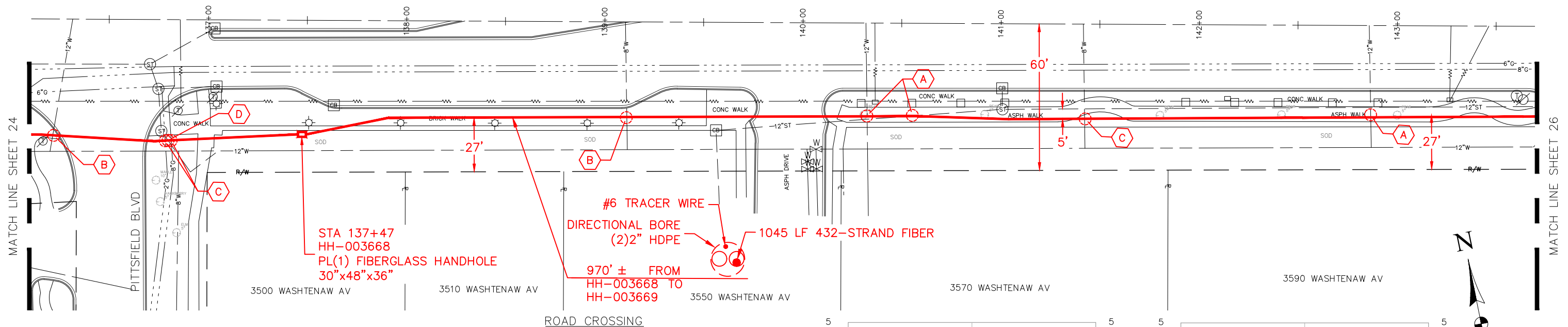

STA 137+47
HH-003668
PL(1) FIBERGLASS HANDHOLE
30"x48"x36"

#6 TRACER WIRE
DIRECTIONAL BORE
(2)2" HDPE
970' ± FROM
HH-003668 TO
HH-003669

- UTILITY CROSSING/POTHOLE NOTES**
- A** POTHOLE. REMOVE & REPLACE (1) SQFT ASPH ROAD.
 - B** POTHOLE. REMOVE & REPLACE (1) FLAG CONC WALK.
 - C** POTHOLE. REMOVE & REPLACE GREENBELT.
 - D** NO POTHOLE NECESSARY. UTILITY DEPTH TO BE VERIFIED AT NEAREST STRUCTURE.

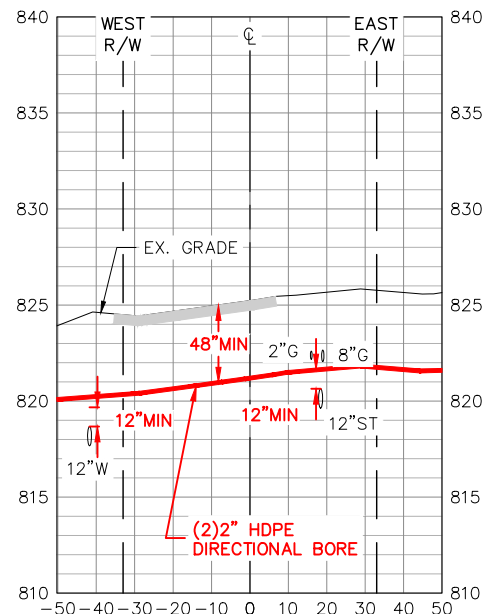

PITTSFIELD BLVD
LOOKING NORTH
1"=50' HORIZONTAL
1"=10' VERTICAL

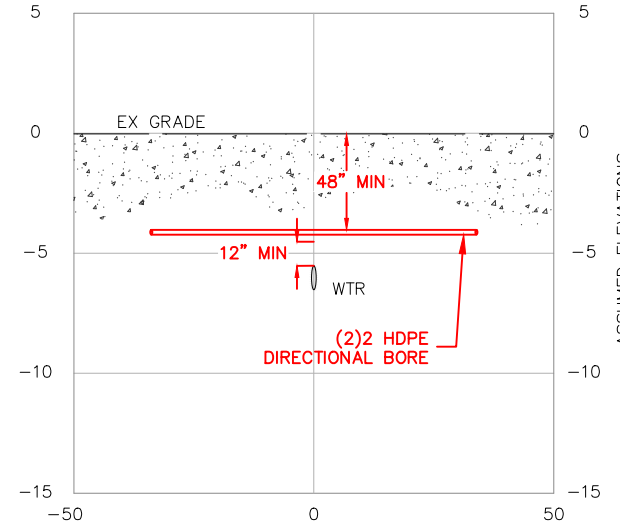

UTILITY CROSSING DETAIL
WASHTENAW AVE
STA 139+10, 140+32, 141+42,
142+88
NOT TO SCALE

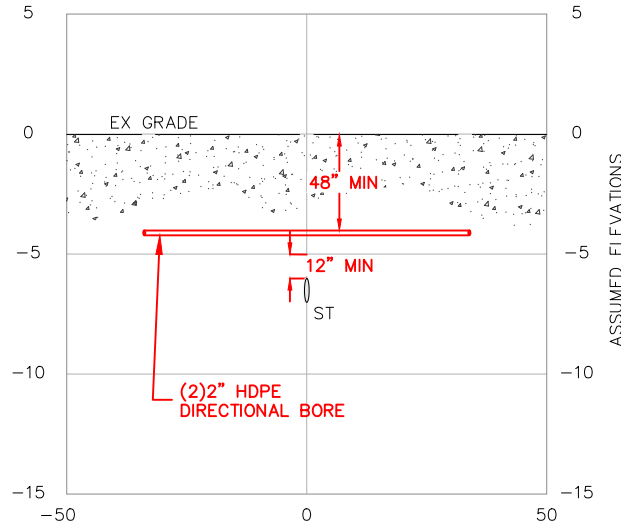

UTILITY CROSSING DETAIL
WASHTENAW AVE
STA 139+57
NOT TO SCALE

REVISION		
REV #	DATE	DESCRIPTION
01	06/07/23	CORRECTED DRAIN CROSSING SHT 23
02	07/10/23	ADD BORE PIT DIM SHT 06. DEPTH NOTE ADDED SHTS 18-20
03	07/18/23	REVISED PER CITY OF ANN ARBOR COMMENTS
04	07/25/23	REVISED PER AA FORESTRY COMMENTS
05	08/22/23	REVISED PER CITY OF ANN ARBOR COMMENTS
06	08/28/23	REVISED PER CITY OF ANN ARBOR COMMENTS



THE LOCATIONS OF EXISTING UNDERGROUND UTILITIES ARE SHOWN IN AN APPROXIMATE WAY ONLY AND HAVE NOT BEEN INDEPENDENTLY VERIFIED. THE CONTRACTOR SHALL DETERMINE THE EXACT LOCATION OF ALL EXISTING UTILITIES BEFORE COMMENCING WORK, AND AGREES TO BE FULLY RESPONSIBLE FOR ANY AND ALL DAMAGES WHICH MIGHT BE OCCASIONED BY THE CONTRACTOR'S FAILURE TO EXACTLY LOCATE AND PRESERVE ANY AND ALL UNDERGROUND UTILITIES.

METRO ENGINEERING SOLUTIONS
33900 SCHOOLCRAFT RD
LIVONIA, MICHIGAN 48150
PHONE: 734.483.1427 FAX: 734.483.3431
www.metroes.net

NORTH ROUTE - WEST OF U.S. 23	
MES JOB# 1043-22	DRAWN - KMM
PLOT SCALE = 1" = 50'	CHECKED - JB
PLAN DATE = 05/09/2023	

ANN ARBOR SPARK
CORRIDOR FIBER OPTIC BACKBONE PROJECT
ANN ARBOR
WASHTENAW COUNTY, MI

PERMITS REQUIRED:

<input checked="" type="checkbox"/> CITY OF ANN ARBOR	<input type="checkbox"/> CITY OF YPSILANTI	<input type="checkbox"/> EGLE
<input type="checkbox"/> WASHTENAW COUNTY	<input type="checkbox"/> YPSILANTI TOWNSHIP	<input type="checkbox"/> RR
<input checked="" type="checkbox"/> WASHTENAW COUNTY DRAIN	<input type="checkbox"/> PITTSFIELD TOWNSHIP	<input checked="" type="checkbox"/> MDOT

SHEET INFORMATION

TOTAL SHEETS	SHEET NO.
26	25

K:\2022\1043 JOB FOLDERS\1043-22-0325\DWG\1043-22-0325_DS.dwg; 8/28/2023 11:21 AM;

CITY OF ANN ARBOR
SEC:02 T:03S R:06E

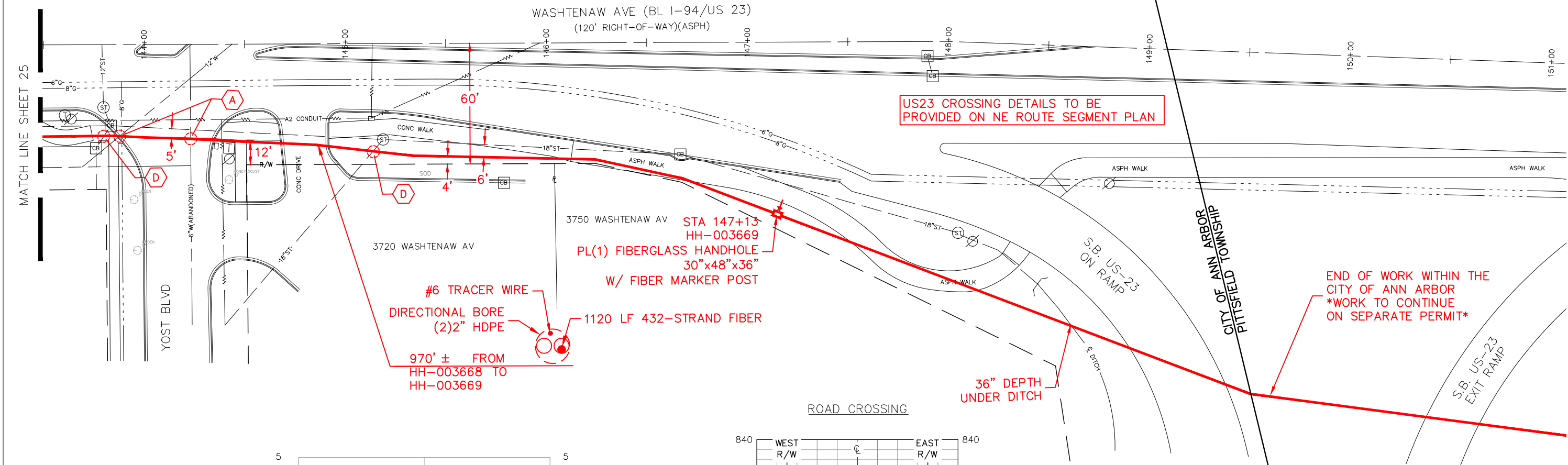

#6 TRACER WIRE
DIRECTIONAL BORE
(2)2" HDPE
970' ± FROM
HH-003668 TO
HH-003669

1120 LF 432-STRAND FIBER

3750 WASHTEAW AV STA 147+13
HH-003669
PL(1) FIBERGLASS HANDHOLE
30"x48"x36"
W/ FIBER MARKER POST

US23 CROSSING DETAILS TO BE PROVIDED ON NE ROUTE SEGMENT PLAN

END OF WORK WITHIN THE CITY OF ANN ARBOR
WORK TO CONTINUE ON SEPARATE PERMIT

36" DEPTH UNDER DITCH

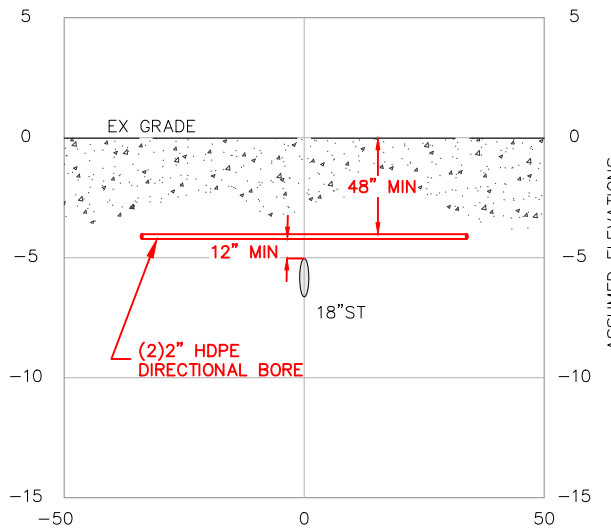

UTILITY CROSSING DETAIL
WASHTEAW AVE
STA 145+12
NOT TO SCALE

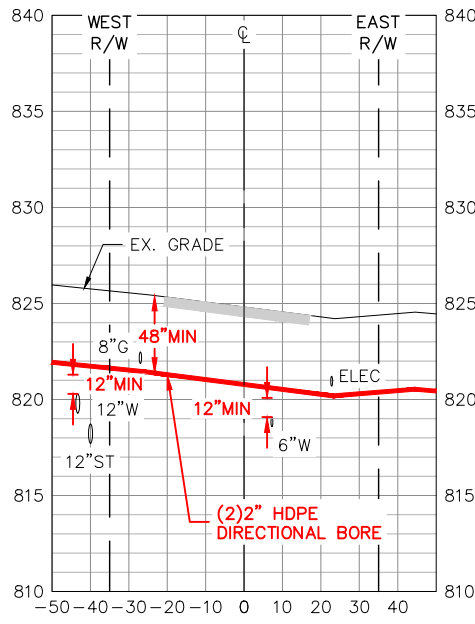

YOST BLVD
LOOKING NORTH
1"=50' HORIZONTAL
1"=10' VERTICAL

- UTILITY CROSSING/POTHOLE NOTES**
- A POTHOLE. REMOVE & REPLACE (1) SQFT ASPH ROAD.
 - B POTHOLE. REMOVE & REPLACE (1) FLAG CONC WALK.
 - C POTHOLE. REMOVE & REPLACE GREENBELT.
 - D NO POTHOLE NECESSARY. UTILITY DEPTH TO BE VERIFIED AT NEAREST STRUCTURE.

REVISION		
REV #	DATE	DESCRIPTION
01	06/07/23	CORRECTED DRAIN CROSSING SHT 23
02	07/10/23	ADD BORE PIT DIM SHT 06. DEPTH NOTE ADDED SHTS 18-20
03	07/18/23	REVISED PER CITY OF ANN ARBOR COMMENTS
04	07/25/23	REVISED PER AA FORESTRY COMMENTS
05	08/22/23	REVISED PER CITY OF ANN ARBOR COMMENTS
06	08/28/23	REVISED PER CITY OF ANN ARBOR COMMENTS



THE LOCATIONS OF EXISTING UNDERGROUND UTILITIES ARE SHOWN IN AN APPROXIMATE WAY ONLY AND HAVE NOT BEEN INDEPENDENTLY VERIFIED. THE CONTRACTOR SHALL DETERMINE THE EXACT LOCATION OF ALL EXISTING UTILITIES BEFORE COMMENCING WORK, AND AGREES TO BE FULLY RESPONSIBLE FOR ANY AND ALL DAMAGES WHICH MIGHT BE OCCASIONED BY THE CONTRACTOR'S FAILURE TO EXACTLY LOCATE AND PRESERVE ANY AND ALL UNDERGROUND UTILITIES.

METRO ENGINEERING SOLUTIONS
33900 SCHOOLCRAFT RD
LIVONIA, MICHIGAN 48150
PHONE: 734.483.1427 FAX: 734.483.3431
www.metroes.net

NORTH ROUTE - WEST OF U.S. 23	
MES JOB# 1043-22	DRAWN - KMM
PLOT SCALE = 1" = 50'	CHECKED - JB
PLAN DATE = 05/09/2023	

ANN ARBOR SPARK
CORRIDOR FIBER OPTIC BACKBONE PROJECT
ANN ARBOR
WASHTEAW COUNTY, MI

PERMITS REQUIRED:

<input checked="" type="checkbox"/> CITY OF ANN ARBOR	<input type="checkbox"/> CITY OF YPSILANTI	<input type="checkbox"/> EGLE
<input type="checkbox"/> WASHTEAW COUNTY	<input type="checkbox"/> YPSILANTI TOWNSHIP	<input type="checkbox"/> RR
<input checked="" type="checkbox"/> WASHTEAW COUNTY DRAIN	<input type="checkbox"/> PITTSFIELD TOWNSHIP	<input checked="" type="checkbox"/> MDOT

SHEET INFORMATION

TOTAL SHEETS	SHEET NO.
26	26

K:\2022\1043 JOB FOLDERS\1043-22-0325\DWG\1043-22-0325_DS.dwg; 8/28/2023 11:21 AM;

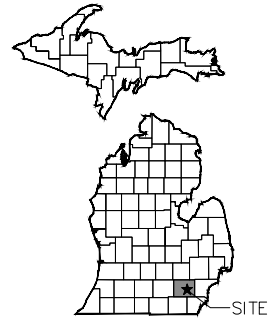

**EDA Project Number:
06-79-06299**



LEGEND

- R/W — EX. RIGHT OF WAY
- - - - - EX. EASEMENT LINE
- - - - - EX. Q. DITCH
- - - - - EX. GRAVEL
- - - - - EX. WETLAND LIMITS
- ==== EX. CURB/PAVEMENT
- + + + + + RR TRACK
- - ○ - ○ - ○ EX. FENCE(STEEL)
- - □ - □ - □ EX. FENCE(WOOD)
- - ○ - ○ - ○ EX. GUARDRAIL
- ~ ~ ~ ~ ~ EX. TREELINE
- - - - - EX. WATER MAIN
- - - - - EX. STORM SEWER
- - - - - EX. SANITARY SEWER
- - - - - EX. UNGD GAS
- - - - - EX. UNGD ELECTRIC
- - - - - EX. UNGD TELE
- - - - - EX. UNGD CABLE
- - - - - EX. UNGD STEAM
- - ○ - ○ - ○ EX. OH ELECTRIC
- - ○ - ○ - ○ EX. WATER VALVE
- - ○ - ○ - ○ EX. HYDRANT
- - ○ - ○ - ○ EX. WATER MANHOLE
- - ○ - ○ - ○ EX. STORM INLET/CATCH BASIN
- - ○ - ○ - ○ EX. ROUND STORM CATCH BASIN
- - ○ - ○ - ○ EX. STORM MANHOLE
- - ○ - ○ - ○ EX. STORM END SECTION
- - ○ - ○ - ○ EX. SANITARY MANHOLE
- - ○ - ○ - ○ EX. STEAM MANHOLE
- - ○ - ○ - ○ EX. GAS VALVE
- - ○ - ○ - ○ EX. GAS METER
- - ○ - ○ - ○ EX. ELECTRIC MANHOLE
- - ○ - ○ - ○ EX. ELECTRIC TRANS
- - ○ - ○ - ○ EX. UTILITY POLE
- - ○ - ○ - ○ EX. LIGHT POLE
- - ○ - ○ - ○ EX. TRAFFIC SIGNAL POLE
- - ○ - ○ - ○ EX. GUY WIRE
- - ○ - ○ - ○ EX. TELE MANHOLE
- - ○ - ○ - ○ EX. TELE PED
- - ○ - ○ - ○ EX. UNIDENTIFIED MANHOLE
- - ○ - ○ - ○ EX. TREE
- - ○ - ○ - ○ EX. SIGN
- — — — — PROP DESIGN UNGD
- PROP HANDHOLE
- PROP SIDEWALK RESTORATION
- PROP UTILITY CROSSING
- PROP FIBER MARKER POST

PERMITTING AGENCIES

MUNICIPALITY:

PITTSFIELD TOWNSHIP
6201 W. MICHIGAN AVE.
ANN ARBOR, MI 48108
(734) 794-6320

MUNICIPALITY:

YPSILANTI TOWNSHIP
BUILDING DEPT
7200 S. HURON RIVER DR.
YPSILANTI, MI 48197
(734) 485-3943

MUNICIPALITY:

CITY OF YPSILANTI
DEPT OF PUBLIC SERVICES
14 WEST FOREST AVE.
YPSILANTI, MI 48128
(734) 483-1421

DRAIN:

WASHTENAW COUNTY
WATER RESOURCE COMMISSION
705 N ZEEB ROAD
ANN ARBOR, MI 48103

COUNTY:

WASHTENAW COUNTY
ROAD COMMISSION
PERMIT ENGINEERING SECTION
555 N. ZEEB ROAD
ANN ARBOR, MI 48103

DOT:

MDOT
BRIGHTON TSC
10321 E GRAND RIVER, SUITE 500
BRIGHTON, MI 48116
(810)227-4681

SHEET INDEX

SHEET #(s)	DESCRIPTION
01	LOCATOR MAP & INDEX
02	NOTES
03	HANDHOLE & FIBER MARKER DETAIL
04	SPLICE & SLACK DETAILS
05	SIDEWALK RESTORATION DETAILS
06-35	PLAN SHEETS & CROSS SECTIONS



October 10, 2023

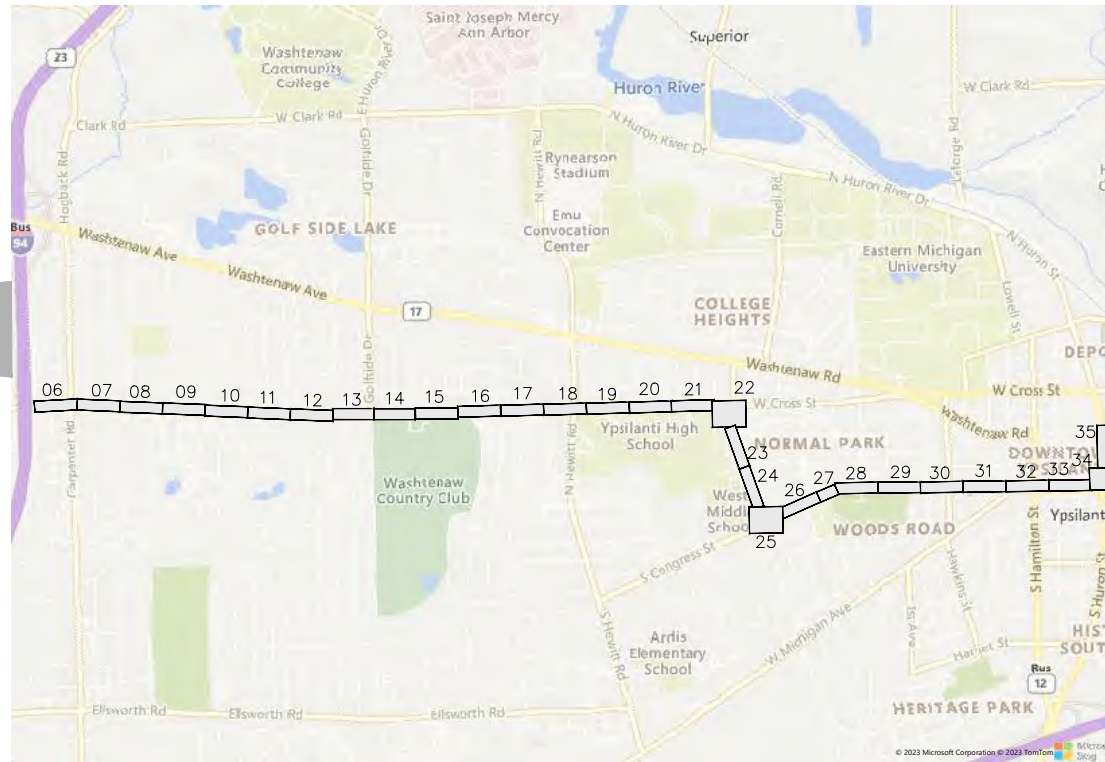
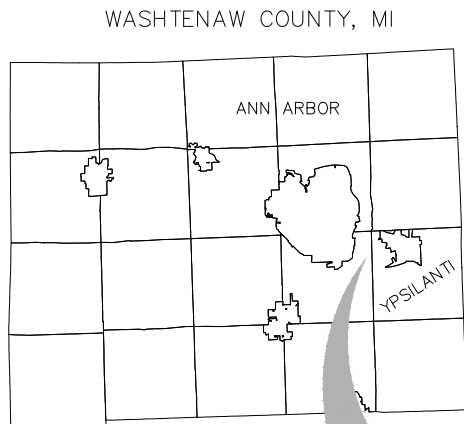

ANN ARBOR SPARK FIBER BACKBONE INFRASTRUCTURE
THIS PROJECT WILL PLACE INFRASTRUCTURE FOR THE PLACEMENT OF FIBER OPTIC CABLE TO CONNECT THE CITY OF ANN ARBOR WITH THE CITY OF YPSILANTI



THE LOCATIONS OF EXISTING UNDERGROUND UTILITIES ARE SHOWN IN AN APPROXIMATE WAY ONLY AND HAVE NOT BEEN INDEPENDENTLY VERIFIED. THE CONTRACTOR SHALL DETERMINE THE EXACT LOCATION OF ALL EXISTING UTILITIES BEFORE COMMENCING WORK, AND AGREES TO BE FULLY RESPONSIBLE FOR ANY AND ALL DAMAGES WHICH MIGHT BE OCCASIONED BY THE CONTRACTOR'S FAILURE TO EXACTLY LOCATE AND PRESERVE ANY AND ALL UNDERGROUND UTILITIES.

METRO ENGINEERING SOLUTIONS
33900 SCHOOLCRAFT RD
LIVONIA, MICHIGAN 48150
PHONE: 734.483.1427 FAX: 734.483.3431
www.metroes.net

SOUTH ROUTE - EAST OF U.S. 23	
MES JOB#	1043-22
DRAWN	KMM
PLOT SCALE	1" = 50'
CHECKED	JB
PLAN DATE	10/10/2023

ANN ARBOR SPARK	
CORRIDOR FIBER OPTIC BACKBONE PROJECT	
ANN ARBOR	
WASHTENAW COUNTY, MI	

PERMITS REQUIRED:		
<input type="checkbox"/>	CITY OF ANN ARBOR	<input checked="" type="checkbox"/>
<input checked="" type="checkbox"/>	WASHTENAW COUNTY	<input checked="" type="checkbox"/>
<input checked="" type="checkbox"/>	WASHTENAW COUNTY DRAIN	<input checked="" type="checkbox"/>
<input checked="" type="checkbox"/>	CITY OF YPSILANTI	<input type="checkbox"/>
<input checked="" type="checkbox"/>	YPSILANTI TOWNSHIP	<input type="checkbox"/>
<input checked="" type="checkbox"/>	PITTSFIELD TOWNSHIP	<input checked="" type="checkbox"/>
<input type="checkbox"/>	EGLE	<input type="checkbox"/>
<input type="checkbox"/>	RR	<input type="checkbox"/>
<input checked="" type="checkbox"/>	MDOT	<input type="checkbox"/>

SHEET INFORMATION	
TOTAL SHEETS	35
SHEET NO.	01

REVISION		
REV #	DATE	DESCRIPTION
01	07/13/23	REV BORE PATH SHTS 10-13 FOR CLEARANCE FROM DRAIN
02	08/01/23	ADD DEPTH NOTE SHT 12
03	09/06/23	REVISED PER WCRC.WCWR & PITTSFIELD TWP COMMENTS
04	10/10/23	REVISED PER WCRC COMMENTS

GENERAL REQUIREMENTS

- A. ALL WORK PERFORMED BY THE CONTRACTOR SHALL BE IN ACCORDANCE WITH THE CITY'S SPECIFICATIONS AND ALL APPLICABLE STANDARDS INCLUDED BUT NOT LIMITED TO THE FOLLOWING:
 - a. ANSI, ATIS, ASTM, BOCA, BICSI, EIA, IEEE, MI-OSHA, NEMA NESC, NFPA, OSHA, TIA, UL, AND ANY OTHER APPLICABLE INDUSTRY STANDARD(S).
- B. ALL TRAFFIC CONTROL NEEDED TO PERFORM ANY AND ALL PORTIONS OF THE WORK IS THE RESPONSIBILITY OF THE CONTRACTOR AND SHALL BE INCLUDED IN THE COST, REGARDLESS OF THE NUMBER OF TRAFFIC CONTROL MOBILIZATIONS AND SETUPS REQUIRED.
- C. ANY DAMAGE TO AND NOT LIMITED TO: LANDSCAPING, PRIVATE PROPERTY, UNIVERSITY OF MICHIGAN PROPERTY, ROADS, CURB AND GUTTER, SIDEWALK, OR EXISTING UTILITIES SHALL BE REPAIRED BY THE CONTRACTOR AND/OR ANY THEIR SUB-CONTRACTOR(S) IMMEDIATELY AT NO COST TO THE PROJECT.
- D. THE CONTRACTOR SHALL CONFINE WORK TO ROW PROPERTY AT ALL TIMES. AT NO TIME, SHALL THE CONTRACTOR ENTER PRIVATE PROPERTY, UNIVERSITY OF MICHIGAN PROPERTY, OR PERFORM ANY WORK NOT AUTHORIZED BY THE CITY OF ANN ARBOR.
- E. THE CONTRACTOR IS RESPONSIBLE FOR LOCATING ALL EXISTING UNDERGROUND SERVICES INCLUDING: ELECTRIC, GAS, TELEPHONE, DATA, WATER, AND SEWER PRIOR TO BEGINNING ANY UNDERGROUND WORK. COORDINATION AND COMPLIANCE WITH MISS DIG ARE REQUIRED.
- F. THE CONTRACTOR WILL PROVIDE EXPERIENCED INSTALLERS WHO ARE LICENSED OR CERTIFIED TO INSTALL CORNING FIBER MANUFACTURED MATERIAL.
- G. THE CONTRACTOR IS REQUIRED TO FACILITATE INSPECTIONS OF WORK WITH CITY OF ANN ARBOR AND THE CITY'S DESIGNATED REPRESENTATIVE (DESIGN, ENGINEERING SERVICES CONTRACTOR) THAT IS PROVIDING CONSTRUCTION OVERSIGHT UNDER A SEPARATE CONTRACT. ANY DEFICIENCIES REVEALED DURING INSPECTIONS BY CITY AND/OR DESIGNATED REPRESENTATIVES OF THE CITY OF ANN ARBOR, ARE THE SOLE RESPONSIBILITY OF THE CONTRACTOR TO RESOLVE.
- H. WHEN CONSTRUCTION IS COMPLETED, THE CONTRACTOR SHALL PERFORM CONTINUITY TESTING OF OPTICAL FIBERS USING OTDR AND INDUSTRY STANDARDS FOR TESTING. REFER TO SECTION "ACCEPTANCE AND TESTING" FOR REQUIREMENTS.
- I. THE CONTRACTOR SHALL INSTALL NECESSARY LIGHTING PROTECTION IN ACCORDANCE WITH AFOREMENTIONED STANDARDS.
- J. GROUNDING FOR UNDERGROUND NETWORK SEGMENTS IS REQUIRED AT EVERY SPLICE ENCLOSURE WITH A MINIMUM OF 8 (EIGHT) FEET OF GROUNDING ROD. GROUNDING RODS MUST MEET APPLICABLE INDUSTRY STANDARD SPECIFICATIONS.
- K. THE CONTRACTOR MUST ENSURE ADEQUATE CLEARANCE EXISTS BETWEEN PROPOSED FIBER BUILD AND OTHER UTILITIES, GROUND, RAIL, ROADS, AND WATER. AT A MINIMUM THE CONTRACTOR IS REQUIRED TO BUILD CONFORMING TO NESC CODES.
- L. THE CONTRACTOR IS ALSO RESPONSIBLE TO VERIFY LOCAL UTILITIES DO NOT HAVE MORE STRINGENT CLEARANCE CODES.
- M. THE CONTRACTOR IS RESPONSIBLE FOR ADHERING TO ALL RIGHT-OF-WAY AND UTILITY PERMITTING TERMS AND CONDITIONS AS SET FORTH IN EACH RIGHT-OF-WAY PERMIT.
- N. ANY CONSTRUCTION CHANGES MUST BE PRE-APPROVED BY THE CITY OF ANN ARBOR AND THE CITY OF ANN ARBOR'S DESIGN AND PLANNING CONTRACTOR BEFORE COMMENCING WITH SAID CHANGE. REDLINE EDITED DRAWINGS IN AUTOCAD FORMAT WILL BE REQUIRED TO DOCUMENT ANY APPROVED CHANGES.
- O. IF DEFICIENCIES AND/OR NON-COMPLIANCE ISSUES ARE DISCOVERED BY THE CITY OF ANN ARBOR PROJECT MANAGER OR THE CITY OR ANN ARBOR'S DESIGN AND PLANNING CONTRACTOR THE CONTRACTOR IS RESPONSIBLE FOR THE CORRECTION.
- P. THE CONTRACTOR IS RESPONSIBLE FOR ALL JOBSITE CLEANUP AND FOR REMOVAL OF ALL SPENT FIBER REELS AND OTHER MATERIALS USED DURING CONSTRUCTION.
- Q. CONSTRUCTION WILL BE SUBJECT TO PERIODIC INSPECTIONS BY CORNING AND THE CONSTRUCTION CONTRACTOR MUST COMPLY WITH ANY MODIFICATIONS MADE BY CORNING IN ORDER FOR THE CITY TO MAINTAIN ITS CORNING WARRANTY
- R. THE CONTRACTOR IS RESPONSIBLE FOR THE RESTORATION OF THE WORK AREA, INCLUDING LANDSCAPING, TO ITS ORIGINAL CONDITION AFTER WORK IS COMPLETE. SURROUNDING AREA MUST BE FILLED, LEVELED, AND COMPACTED. IF GRASS RESTORATION IS REQUIRED, CONTRACTOR MUST APPLY SEED OR HYDRO SEED. IF WORK CANNOT BE COMPLETED DUE TO UNSEASONAL CONDITIONS, THE WORK WILL BE COMPLETED WHEN FEASIBLE AND WITHIN THE 1-YEAR WARRANTY PERIOD. PAYMENT FOR PROJECTS WITH OUTSTANDING WORK DUE TO UNSEASONAL CONDITIONS WILL BE NEGOTIATED ON A PER PROJECT BASIS. AN ACTIVE PROJECT PUNCH LIST OF ITEMS WILL BE DOCUMENTED AND TRACKED BY THE CITY OF ANN ARBOR PROJECT MANAGER UNTIL ALL WORK HAS BEEN COMPLETED.
- S. IF POTHOLING IS REQUIRED IN SIDEWALK CONCRETE THE ENTIRE CONCRETE SLAB MUST BE RESTORED, NOT JUST THE POTHOLE AREA

M-DOT NOTES:

- A) DIRECTIONAL DRILLING SHALL BE CONSTRUCTED PER THE MDOT TRENCHLESS SPECIFICATION 3703A.
- B) NO PARKING OR STORAGE OF MATERIAL OR EQUIPMENT WILL BE ALLOWED WITHIN THE M-DOT RIGHT-OF-WAY.
- C) REMOVE AND REPLACE SIDEWALK AS DIRECTED BY THE FIELD INSPECTOR. UNLESS OTHERWISE SPECIFIED, ANY DAMAGED SIDEWALK SHALL BE REPLACED IN ACCORDANCE TO MDOT STANDARD DETAILS R-29 SERIES AND R-28 SERIES FOR SIDEWALK RAMPS.
- D) NO OPEN EXCAVATION SHALL REMAIN OVERNIGHT. ALL ACCESS PITS, OPEN EXCAVATION, EQUIPMENT AND SUPPLIES SHALL BE PROTECTED WITH SUITABLE FENCING AND PLASTIC DRUMS TO PROHIBIT PEDESTRIAN ACCESS TO THE WORK SITE. EQUIPMENT SHALL NOT BE USED AS FENCING TO PROTECT ACCESS PITS.
- E) A SAFE AND ADEQUATE TRAVEL ROUTE FOR PEDESTRIANS SHALL BE MAINTAINED AT ALL TIMES. PEDESTRIANS SHALL NOT BE DETOURED INTO THE ROADWAY OR DIRECTED TO CROSS THE TRUNKLINE AT NON SIGNALIZED INTERSECTIONS.
- F) ALL TRAFFIC CONTROL DEVICES INCLUDING SIGNS AND PAVEMENT MARKINGS (REMOVAL AND INSTALLATIONS) SHALL BE MAINTAINED AND/OR INSTALLED IN ACCORDANCE WITH CURRENT MDOT STANDARDS AND SPECIFICATIONS. CHARGES ARE THE SOLE RESPONSIBILITY OF THE PERMITTED.
- G) PERMITTEE AND CONTRACTORS ARE SUBJECT TO: PART 201, PUBLIC ACT 451 OF 1994, AS AMENDED. IN THE EVENT OF EXCAVATION ENCOUNTERING ENVIRONMENTAL CONTAMINATION OR AN UNDERGROUND TANK IN MDOT RIGHT-OF-WAY, WORK WITHIN THE RIGHT OF WAY SHALL CEASE UNTIL ALL ACTIONS/NOTIFICATIONS SPECIFIED BY PART 201 HAVE BEEN COMPLETED.
- H) PERMITTEE AND CONTRACTORS ARE SUBJECT TO PART 91, PUBLIC ACT 451 OF 1994, AS AMENDED. SOIL EROSION AND SEDIMENTATION CONTROL.
- I) ALL TRAFFIC CONTROL DEVICES USED ON THIS PERMIT SHALL MEET THE REQUIREMENTS OF THE "MICHIGAN MANUAL OF UNIFORM TRAFFIC CONTROL DEVICES," (MMUTCD) CURRENT EDITION, AND THE AMERICAN TRAFFIC SAFETY ASSOCIATION (ATSA) "QUALITY DEVICES ARE INCLUSIVE OF BUT NOT LIMITED TO SIGNS, BARRICADES, VERTICAL PANELS, DRUMS, WARNING LIGHTS, ARROW BOARDS, CHANGEABLE MESSAGE SIGNS, CONES, TUBULAR MARKERS, PAVEMENT TAPE, PAINT AND PAVEMENT MARKERS.
- J) ALL UTILITIES INCLUDING DRAINAGE FACILITIES SHALL BE LOCATED PRIOR TO EXCAVATION IN THE MDOT RIGHT-OF-WAY. MDOT FACILITIES ARE NOT LOCATED THROUGH THE MISS DIG SYSTEM. CONTACT THE MDOT PERMIT UNIT FOR INSTRUCTIONS.
- K) THE CONTRACTOR SHALL HAVE A MICHIGAN DEPARTMENT OF TRANSPORTATION APPROVED PLAN AND PERMIT ON-SITE AT ALL TIMES.
- L) THE CONTRACTOR SHALL SUBMIT MDOT ADVANCE NOTICE THROUGH CPS A MINIMUM OF FIVE (5) DAYS PRIOR TO START OF CONSTRUCTION.
- M) THE CONTRACTOR SHALL CONTACT THE INSPECTION AGENCY AS SHOWN ON THE PERMIT 72 HOURS PRIOR TO START OF CONSTRUCTION.
- N) THE CONTRACTOR SHALL CONTACT THE INSPECTION AGENCY AS SHOWN ON THE PERMIT AT THE COMPLETION OF CONSTRUCTION FOR A FINAL INSPECTION.
- O) THE APPLICANT/CONTRACTOR IS REQUIRED TO SUBMIT A COMPLETION NOTIFICATION VIA CPS UPON COMPLETING ALL WORK COVERED UNDER THIS PERMIT.
- P) THE MDOT RIGHT-OF-WAY SHALL BE RESTORED TO PRE-WORK CONDITIONS OR BETTER.
- Q) ALL DRILLING FLUIDS SHALL NOT ENTER THE STREETS, MANHOLES, SANITARY AND STORM SEWERS, AND OTHER DRAINAGE SYSTEMS, INCLUDING STREAMS AND RIVERS.

GENERAL CONSTRUCTION NOTES

- A. SODDED AREAS THAT MAY BE DISTURBED DURING INSTALLATION ARE TO BE RESTORED WITH 3" OF QUALITY TOP SOIL, SEED AND MULCH
- B. MAINTAIN A MINIMUM 18" CLEARANCE FROM ALL EXISTING PUBLIC UTILITIES
- C. PROPOSED INSTALLATION TO BE PLACED AT A MINIMUM DEPTH OF 48", UNLESS OTHERWISE NOTED ON PLANS
- D. SIDEWALK REMOVAL NECESSARY ON THIS PROJECT TO BE ACCOMPLISHED IN COMPLETE FLAGS AND REPLACED IN KIND PER JURISDICTIONAL SPECIFICATIONS
- E. HARD SURFACE REMOVAL OF STREETS AND/OR DRIVEWAYS TO BE SAW CUT FULL DEPTH AND REPLACED IN KIND PER JURISDICTIONAL SPECIFICATIONS
- F. CONTRACTOR TO FIELD VERIFY ALL EXISTING UTILITY LOCATIONS, INVERTS AND GRADES PRIOR TO STARTING CONSTRUCTION
- G. EXCAVATIONS BELOW HARD SURFACES TO BE BACKFILLED WITH MDOT CLASS II GRANULAR MATERIAL IN 8" LAYERS, WELL COMPACTED TO 98% OF ITS MAXIMUM UNIT WEIGHT AT A MOISTURE CONTENT LESS THAN SATURATION
- H. TEST HOLES TO BE CONSTRUCTED AS A 12" CYLINDRICAL HOLE. SOIL TO BE REMOVED USING A VACUUM TRUCK. HOLE TO BE BACKFILLED USING A GRANULAR MATERIAL TO THE BOTTOM OF THE EXISTING PAVEMENT. PAVEMENT TO BE REPLACED IN KIND PER MDOT SPECIFICATIONS

WASHTENAW COUNTY NOTES

- THIS PROJECT WILL INSTALL APPROXIMATELY 11,300' OF FIBER IN WASHTENAW COUNTY RIGHT OF WAY.
- NEW INSTALLATIONS ARE TO BE CONSTRUCTED AT A MINIMUM DEPTH OF 48 INCHES BELOW EXISTING ROAD GRADE OR 36 INCHES BELOW DITCH INVERT WHICHEVER IS GREATER.
- ALL DRIVEWAYS AND SIDEWALKS TO BE VIDEO RECORDED PRIOR TO CONSTRUCTION.
- ALL DISTURBED PEDESTRIAN CROSSINGS SHALL BE REPLACED AND ADA COMPLIANT
- CONTRACTOR TO SUPPLY PEDESTRIAN DETOUR PLAN PRIOR TO CONSTRUCTION AND SUBMIT TO WCRC FOR REVIEW.
- CONTRACTOR TO COORDINATE WITH AATA IF BUS STOPS ARE IMPACTED DURING CONSTRUCTION

ENGINEER ESTIMATE OF MATERIALS	
QTY	ITEM
21105	LINEAR FT OF 2-2" HDPE SDR-11 FOR FIBER
20	30"X48"X36" FIBERGLASS HAND HOLE
24255	LINEAR FT OF 432 STRAND FIBER CABLE
21045	LINEAR FT OF #6 TRACER WIRE
18	FIBER MARKER POST

REVISION		
REV #	DATE	DESCRIPTION
01	07/13/23	REV BORE PATH SHTS 10-13 FOR CLEARANCE FROM DRAIN
02	08/01/23	ADD DEPTH NOTE SHT 12
03	09/06/23	REVISED PER WCRC.WCWR & PITTSFIELD TWP COMMENTS
04	10/10/23	REVISED PER WCRC COMMENTS



THE LOCATIONS OF EXISTING UNDERGROUND UTILITIES ARE SHOWN IN AN APPROXIMATE WAY ONLY AND HAVE NOT BEEN INDEPENDENTLY VERIFIED. THE CONTRACTOR SHALL DETERMINE THE EXACT LOCATION OF ALL EXISTING UTILITIES BEFORE COMMENCING WORK, AND AGREES TO BE FULLY RESPONSIBLE FOR ANY AND ALL DAMAGES WHICH MIGHT BE OCCASIONED BY THE CONTRACTOR'S FAILURE TO EXACTLY LOCATE AND PRESERVE ANY AND ALL UNDERGROUND UTILITIES.

<p>33900 SCHOOLCRAFT RD LIVONIA, MICHIGAN 48150 PHONE: 734.483.1427 FAX: 734.483.3431 www.metroes.net</p>	SOUTH ROUTE - EAST OF U.S. 23		ANN ARBOR SPARK		PERMITS REQUIRED:			SHEET INFORMATION				
	MES JOB#	1043-22	DRAWN	— KMM	<input type="checkbox"/> CITY OF ANN ARBOR <input checked="" type="checkbox"/> CITY OF YPSILANTI <input type="checkbox"/> EGLE			<table border="1"> <tr> <th>TOTAL SHEETS</th> <th>SHEET NO.</th> </tr> <tr> <td>35</td> <td>02</td> </tr> </table>	TOTAL SHEETS	SHEET NO.	35	02
	TOTAL SHEETS	SHEET NO.										
35	02											
PLOT SCALE	= 1" = 50'	CHECKED	- JB	<input checked="" type="checkbox"/> WASHTENAW COUNTY <input checked="" type="checkbox"/> YPSILANTI TOWNSHIP <input type="checkbox"/> RR								
PLAN DATE	= 10/10/2023			<input checked="" type="checkbox"/> WASHTENAW COUNTY DRAIN <input checked="" type="checkbox"/> PITTSFIELD TOWNSHIP <input checked="" type="checkbox"/> MDOT								

CORRIDOR FIBER OPTIC BACKBONE PROJECT
ANN ARBOR
WASHTENAW COUNTY, MI

30"X48"X36" QUAZITE HAND HOLE & FIBER MARKER POST

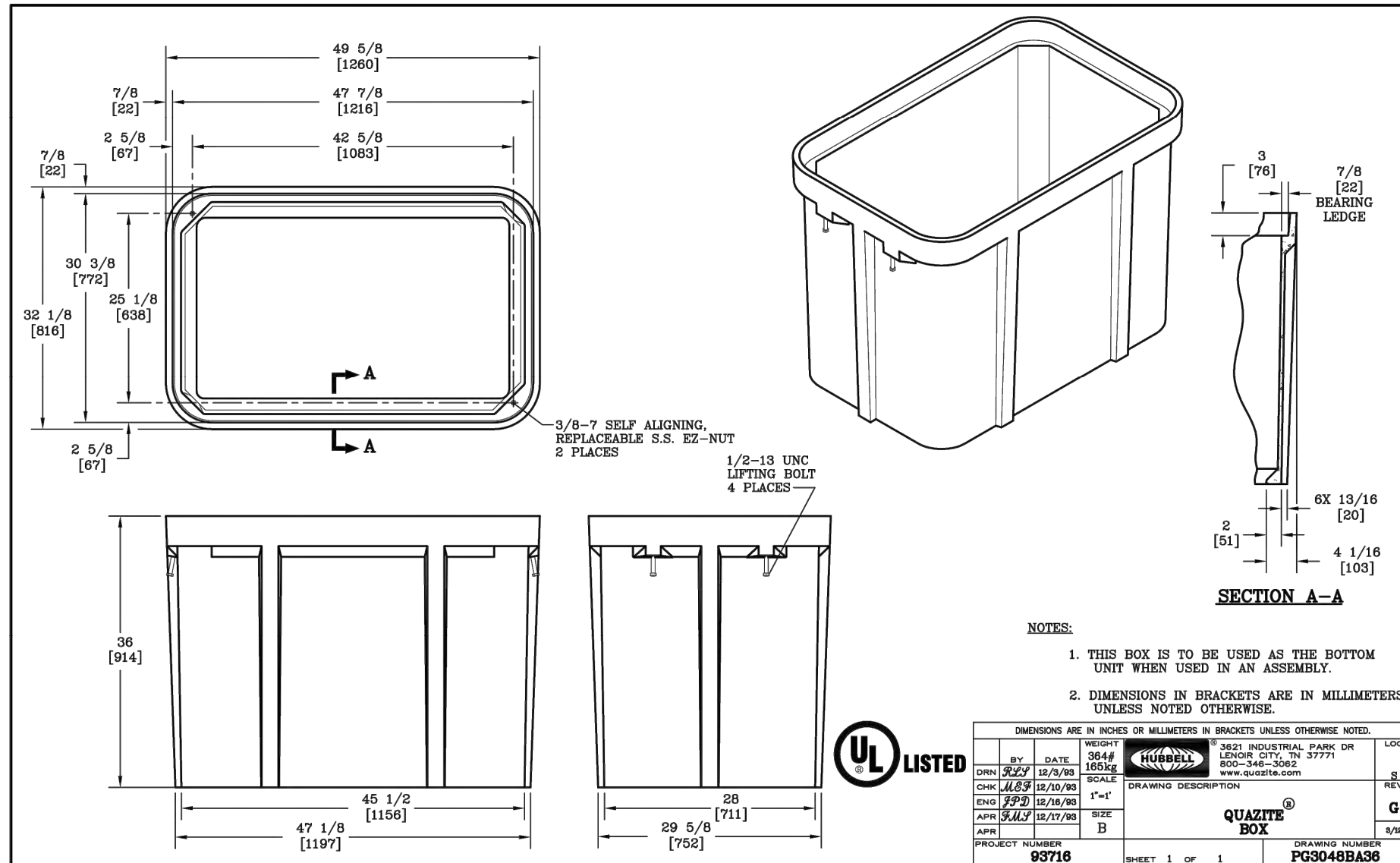

- NOTES:
1. THIS BOX IS TO BE USED AS THE BOTTOM UNIT WHEN USED IN AN ASSEMBLY.
 2. DIMENSIONS IN BRACKETS ARE IN MILLIMETERS UNLESS NOTED OTHERWISE.

DIMENSIONS ARE IN INCHES OR MILLIMETERS IN BRACKETS UNLESS OTHERWISE NOTED.

BY	DATE	WEIGHT	HUBBELL	3621 INDUSTRIAL PARK DR	LOC
DRN	RLV	12/3/93	364#	LENOIR CITY, TN 37771	S
CHK	MSF	12/10/93	165kg	800-346-3062	REV
ENG	FPD	12/16/93	SCALE	www.quazite.com	G
APR	MSF	12/17/93	1"=1'		3/12
APR			SIZE		
			B		
PROJECT NUMBER			DRAWING DESCRIPTION		
93716			QUAZITE [®] BOX		
SHEET 1 OF 1			DRAWING NUMBER		
			PG3048BA36		



THE LOCATIONS OF EXISTING UNDERGROUND UTILITIES ARE SHOWN IN AN APPROXIMATE WAY ONLY AND HAVE NOT BEEN INDEPENDENTLY VERIFIED. THE CONTRACTOR SHALL DETERMINE THE EXACT LOCATION OF ALL EXISTING UTILITIES BEFORE COMMENCING WORK, AND AGREES TO BE FULLY RESPONSIBLE FOR ANY AND ALL DAMAGES WHICH MIGHT BE OCCASIONED BY THE CONTRACTOR'S FAILURE TO EXACTLY LOCATE AND PRESERVE ANY AND ALL UNDERGROUND UTILITIES.

REVISION		
REV #	DATE	DESCRIPTION
01	07/13/23	REV BORE PATH SHTS 10-13 FOR CLEARANCE FROM DRAIN
02	08/01/23	ADD DEPTH NOTE SHT 12
03	09/06/23	REVISED PER WCRC.WCWR & PITTSFIELD TWP COMMENTS
04	10/10/23	REVISED PER WCRC COMMENTS

METRO ENGINEERING SOLUTIONS
 33900 SCHOOLCRAFT RD
 LIVONIA, MICHIGAN 48150
 PHONE: 734.483.1427 FAX: 734.483.3431
 www.metroes.net

SOUTH ROUTE - EAST OF U.S. 23	
MES JOB# 1043-22	DRAWN - KMM
PLOT SCALE = 1" = 50'	CHECKED - JB
PLAN DATE = 10/10/2023	

ANN ARBOR SPARK
 CORRIDOR FIBER OPTIC BACKBONE PROJECT
 ANN ARBOR
 WASHTENAW COUNTY, MI

PERMITS REQUIRED:

<input type="checkbox"/> CITY OF ANN ARBOR	<input checked="" type="checkbox"/> CITY OF YPSILANTI	<input type="checkbox"/> EGLE
<input checked="" type="checkbox"/> WASHTENAW COUNTY	<input checked="" type="checkbox"/> YPSILANTI TOWNSHIP	<input type="checkbox"/> RR
<input checked="" type="checkbox"/> WASHTENAW COUNTY DRAIN	<input checked="" type="checkbox"/> PITTSFIELD TOWNSHIP	<input checked="" type="checkbox"/> MDOT

SHEET INFORMATION

TOTAL SHEETS	SHEET NO.
35	03

K:\2022\1043 JOB FOLDERS\CAD Resources\Titleblocks\South Route-East of US-23\South Route-East of 23_Cover.dwg; 10/10/2023 7:05 AM;

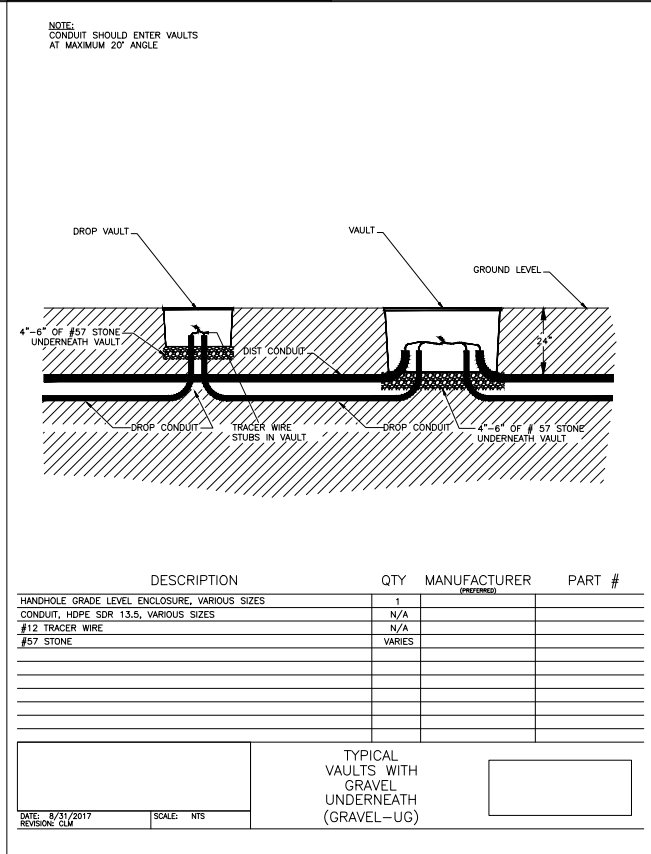
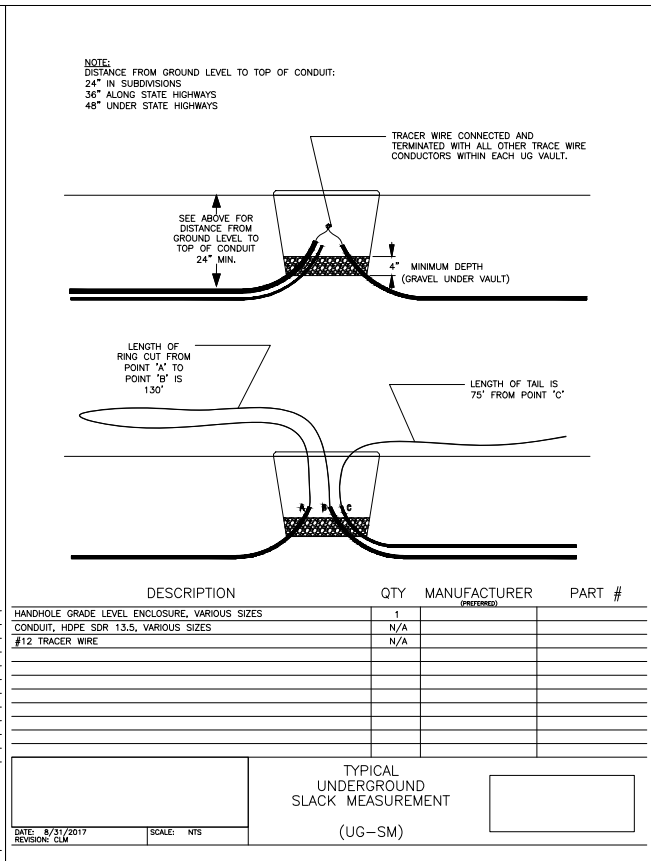
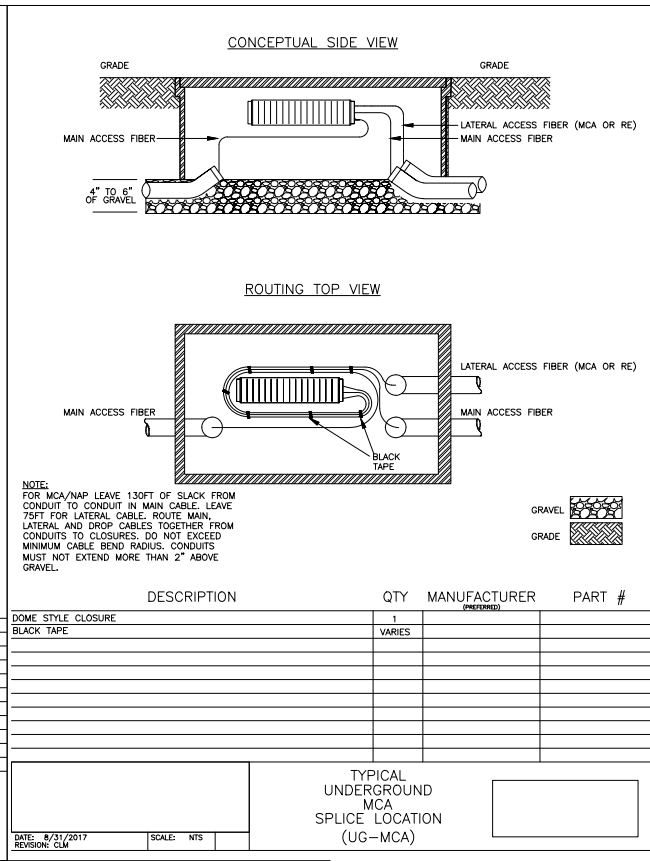
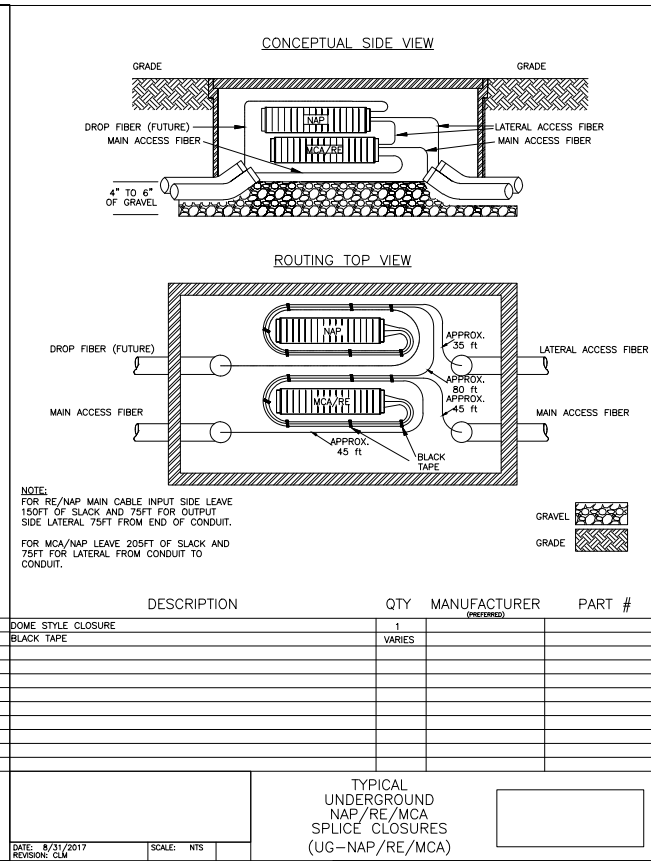
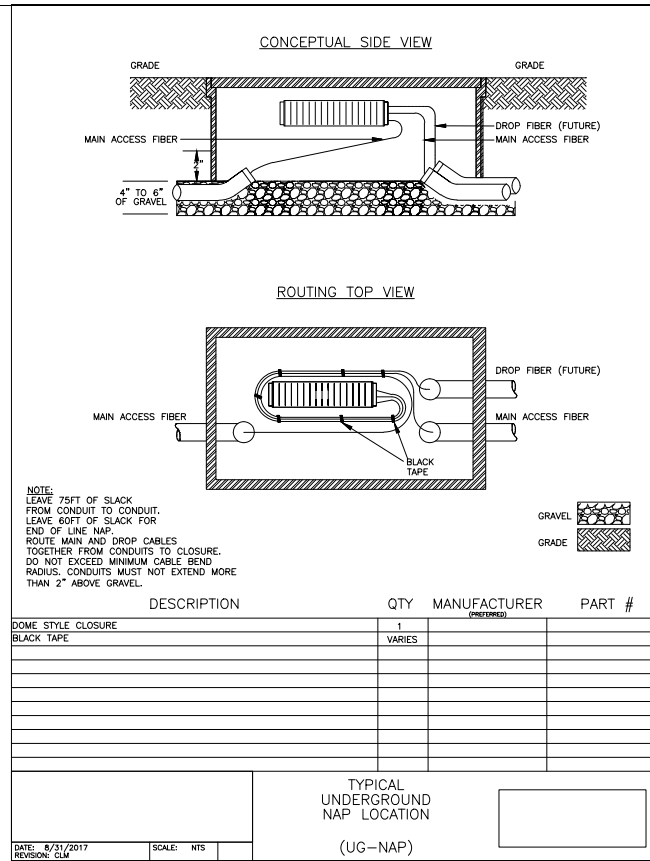

• CABLE ID TAGS ARE REQUIRED WHERE THERE ARE MULTIPLE CABLES WITHIN THE UG VAULTS

• SNAP TAGS ARE REQUIRED WHERE THERE ARE UG CABLES

REVISION		
REV #	DATE	DESCRIPTION
01	07/13/23	REV BORE PATH SHTS 10-13 FOR CLEARANCE FROM DRAIN
02	08/01/23	ADD DEPTH NOTE SHT 12
03	09/06/23	REVISED PER WCRC.WCWR & PITTSFIELD TWP COMMENTS
04	10/10/23	REVISED PER WCRC COMMENTS



Know what's below. Call before you dig.

THE LOCATIONS OF EXISTING UNDERGROUND UTILITIES ARE SHOWN IN AN APPROXIMATE WAY ONLY AND HAVE NOT BEEN INDEPENDENTLY VERIFIED. THE CONTRACTOR SHALL DETERMINE THE EXACT LOCATION OF ALL EXISTING UTILITIES BEFORE COMMENCING WORK, AND AGREES TO BE FULLY RESPONSIBLE FOR ANY AND ALL DAMAGES WHICH MIGHT BE OCCASIONED BY THE CONTRACTOR'S FAILURE TO EXACTLY LOCATE AND PRESERVE ANY AND ALL UNDERGROUND UTILITIES.

METRO ENGINEERING SOLUTIONS
33900 SCHOOLCRAFT RD
LIVONIA, MICHIGAN 48150
PHONE: 734.483.1427 FAX: 734.483.3431
www.metroes.net

SOUTH ROUTE - EAST OF U.S. 23	
MES JOB# 1043-22	DRAWN — KMM
PLOT SCALE = 1" = 50'	CHECKED - JB
PLAN DATE = 10/10/2023	

ANN ARBOR SPARK
CORRIDOR FIBER OPTIC BACKBONE PROJECT
ANN ARBOR
WASHTENAW COUNTY, MI

PERMITS REQUIRED:

<input type="checkbox"/> CITY OF ANN ARBOR	<input checked="" type="checkbox"/> CITY OF YPSILANTI	<input type="checkbox"/> EGLE
<input checked="" type="checkbox"/> WASHTENAW COUNTY	<input checked="" type="checkbox"/> YPSILANTI TOWNSHIP	<input type="checkbox"/> RR
<input checked="" type="checkbox"/> WASHTENAW COUNTY DRAIN	<input checked="" type="checkbox"/> PITTSFIELD TOWNSHIP	<input checked="" type="checkbox"/> MDOT

SHEET INFORMATION

TOTAL SHEETS	SHEET NO.
35	04

K:\2022\1043 JOB FOLDERS\CAD Resources\Titleblocks\South Route-East of US-23\South Route-East of 23_Cover.dwg; 10/10/2023 7:05 AM;

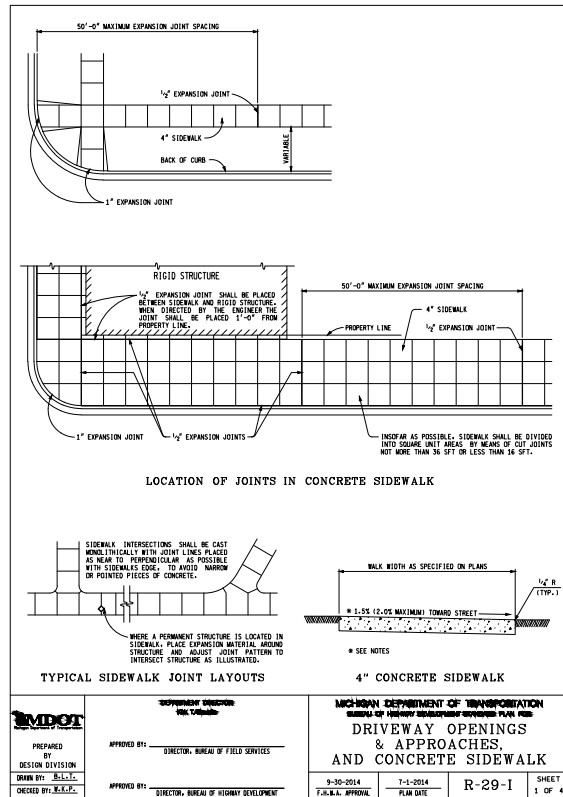

MICHIGAN DEPARTMENT OF TRANSPORTATION BUREAU OF DEVELOPMENT STANDARD PLAN FOR DRIVEWAY OPENINGS & APPROACHES, AND CONCRETE SIDEWALK 9-30-2014 7-1-2014 R-29-I SHEET 1 OF 4 T.S.K.A. APPROVAL PLAN DATE	MICHIGAN DEPARTMENT OF TRANSPORTATION BUREAU OF DEVELOPMENT STANDARD PLAN FOR CURB RAMP AND DETECTABLE WARNING DETAILS 4-7-2022 5-8-2020 R-28-J SHEET 1 OF 1 T.S.K.A. APPROVAL PLAN DATE
--	--

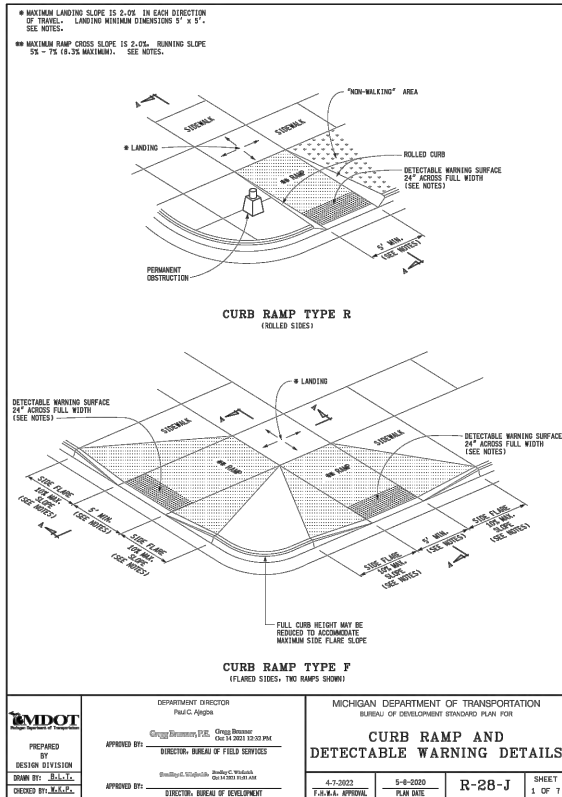

MICHIGAN DEPARTMENT OF TRANSPORTATION BUREAU OF DEVELOPMENT STANDARD PLAN FOR DRIVEWAY OPENINGS & APPROACHES, AND CONCRETE SIDEWALK 9-30-2014 7-1-2014 R-29-I SHEET 1 OF 4 T.S.K.A. APPROVAL PLAN DATE	MICHIGAN DEPARTMENT OF TRANSPORTATION BUREAU OF DEVELOPMENT STANDARD PLAN FOR CURB RAMP AND DETECTABLE WARNING DETAILS 4-7-2022 5-8-2020 R-28-J SHEET 1 OF 1 T.S.K.A. APPROVAL PLAN DATE
--	--

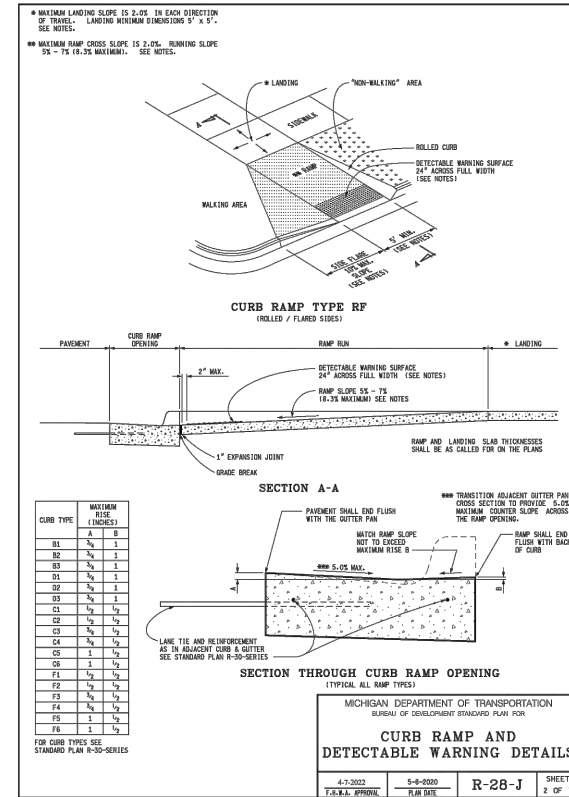

MICHIGAN DEPARTMENT OF TRANSPORTATION BUREAU OF DEVELOPMENT STANDARD PLAN FOR DRIVEWAY OPENINGS & APPROACHES, AND CONCRETE SIDEWALK 9-30-2014 7-1-2014 R-29-I SHEET 1 OF 4 T.S.K.A. APPROVAL PLAN DATE	MICHIGAN DEPARTMENT OF TRANSPORTATION BUREAU OF DEVELOPMENT STANDARD PLAN FOR CURB RAMP AND DETECTABLE WARNING DETAILS 4-7-2022 5-8-2020 R-28-J SHEET 2 OF 1 T.S.K.A. APPROVAL PLAN DATE
--	--

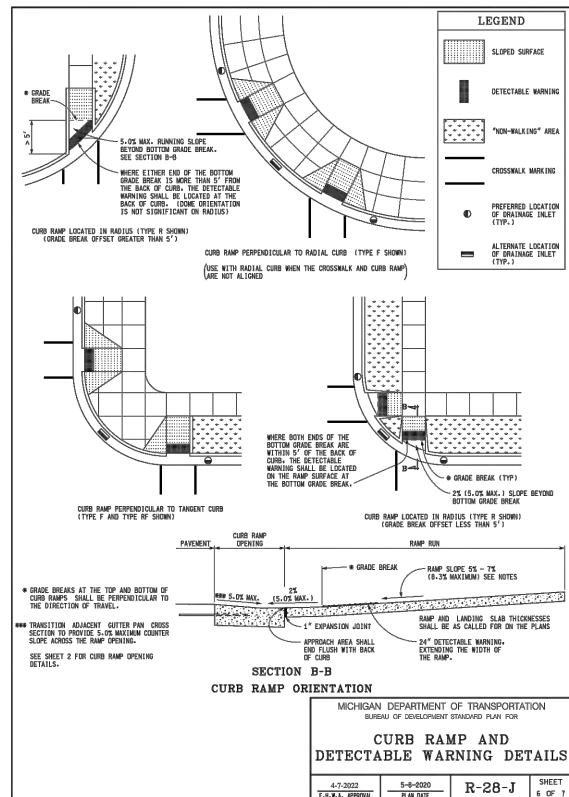

MICHIGAN DEPARTMENT OF TRANSPORTATION BUREAU OF DEVELOPMENT STANDARD PLAN FOR DRIVEWAY OPENINGS & APPROACHES, AND CONCRETE SIDEWALK 9-30-2014 7-1-2014 R-29-I SHEET 1 OF 4 T.S.K.A. APPROVAL PLAN DATE	MICHIGAN DEPARTMENT OF TRANSPORTATION BUREAU OF DEVELOPMENT STANDARD PLAN FOR CURB RAMP AND DETECTABLE WARNING DETAILS 4-7-2022 5-8-2020 R-28-J SHEET 6 OF 1 T.S.K.A. APPROVAL PLAN DATE
--	--

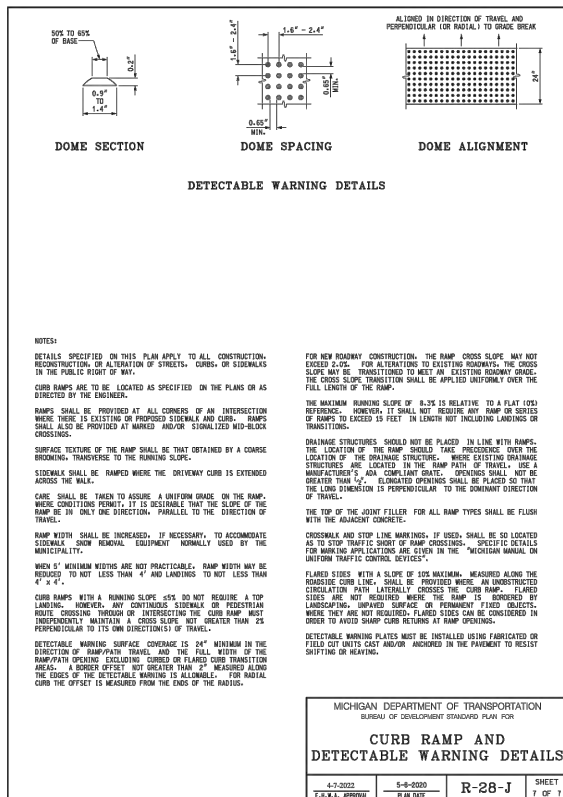

MICHIGAN DEPARTMENT OF TRANSPORTATION BUREAU OF DEVELOPMENT STANDARD PLAN FOR DRIVEWAY OPENINGS & APPROACHES, AND CONCRETE SIDEWALK 9-30-2014 7-1-2014 R-29-I SHEET 1 OF 4 T.S.K.A. APPROVAL PLAN DATE	MICHIGAN DEPARTMENT OF TRANSPORTATION BUREAU OF DEVELOPMENT STANDARD PLAN FOR CURB RAMP AND DETECTABLE WARNING DETAILS 4-7-2022 5-8-2020 R-28-J SHEET 7 OF 1 T.S.K.A. APPROVAL PLAN DATE
--	--

REVISION		
REV #	DATE	DESCRIPTION
01	07/13/23	REV BORE PATH SHTS 10-13 FOR CLEARANCE FROM DRAIN
02	08/01/23	ADD DEPTH NOTE SHT 12
03	09/06/23	REVISED PER WCRC.WCWR & PITTSFIELD TWP COMMENTS
04	10/10/23	REVISED PER WCRC COMMENTS



THE LOCATIONS OF EXISTING UNDERGROUND UTILITIES ARE SHOWN IN AN APPROXIMATE WAY ONLY AND HAVE NOT BEEN INDEPENDENTLY VERIFIED. THE CONTRACTOR SHALL DETERMINE THE EXACT LOCATION OF ALL EXISTING UTILITIES BEFORE COMMENCING WORK, AND AGREES TO BE FULLY RESPONSIBLE FOR ANY AND ALL DAMAGES WHICH MIGHT BE OCCASIONED BY THE CONTRACTOR'S FAILURE TO EXACTLY LOCATE AND PRESERVE ANY AND ALL UNDERGROUND UTILITIES.

METRO ENGINEERING SOLUTIONS

33900 SCHOOLCRAFT RD
LIVONIA, MICHIGAN 48150
PHONE: 734.483.1427 FAX: 734.483.3431
www.metroes.net

SOUTH ROUTE - EAST OF U.S. 23	
MES JOB#	1043-22
DRAWN	KMM
PLOT SCALE	1" = 50'
CHECKED	JB
PLAN DATE	10/10/2023

ANN ARBOR SPARK
CORRIDOR FIBER OPTIC BACKBONE PROJECT
ANN ARBOR
WASHTENAW COUNTY, MI

PERMITS REQUIRED:

<input type="checkbox"/> CITY OF ANN ARBOR	<input checked="" type="checkbox"/> CITY OF YPSILANTI	<input type="checkbox"/> EGLE
<input checked="" type="checkbox"/> WASHTENAW COUNTY	<input checked="" type="checkbox"/> YPSILANTI TOWNSHIP	<input type="checkbox"/> RR
<input checked="" type="checkbox"/> WASHTENAW COUNTY DRAIN	<input checked="" type="checkbox"/> PITTSFIELD TOWNSHIP	<input checked="" type="checkbox"/> MDOT

SHEET INFORMATION

TOTAL SHEETS	35
SHEET NO.	05

PITTSFIELD TOWNSHIP
SEC:12 T:03S R:06E

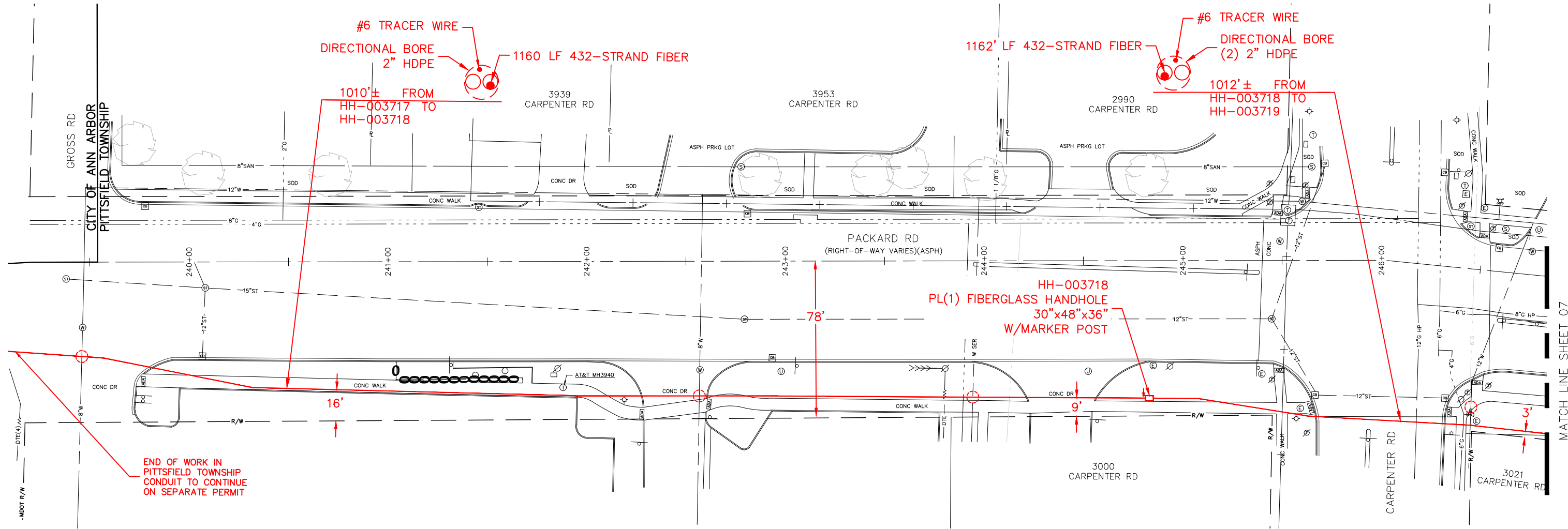

END OF WORK IN
PITTSFIELD TOWNSHIP
CONDUIT TO CONTINUE
ON SEPARATE PERMIT

HH-003718
PL(1) FIBERGLASS HANDHOLE
30"x48"x36"
W/MARKER POST

#6 TRACER WIRE
DIRECTIONAL BORE
2" HDPE
1010'± FROM
HH-003717 TO
HH-003718
1160 LF 432-STRAND FIBER

#6 TRACER WIRE
DIRECTIONAL BORE
(2) 2" HDPE
1162' LF 432-STRAND FIBER
1012'± FROM
HH-003718 TO
HH-003719

MATCH LINE SHEET 07

K:\2022\1043 JOB FOLDERS\1043-22-0321\DWG\1043-22-0321_DS.dwg: 10/10/2023 6:54 AM;



Know what's below.
Call before you dig.

THE LOCATIONS OF EXISTING UNDERGROUND UTILITIES ARE SHOWN IN AN APPROXIMATE WAY ONLY AND HAVE NOT BEEN INDEPENDENTLY VERIFIED. THE CONTRACTOR SHALL DETERMINE THE EXACT LOCATION OF ALL EXISTING UTILITIES BEFORE COMMENCING WORK, AND AGREES TO BE FULLY RESPONSIBLE FOR ANY AND ALL DAMAGES WHICH MIGHT BE OCCASIONED BY THE CONTRACTOR'S FAILURE TO EXACTLY LOCATE AND PRESERVE ANY AND ALL UNDERGROUND UTILITIES.

METRO ENGINEERING SOLUTIONS
33900 SCHOOLCRAFT RD
LIVONIA, MICHIGAN 48150
PHONE: 734.483.1427 FAX: 734.483.3431
www.metroes.net

SOUTH ROUTE - EAST OF U.S. 23	
MES JOB# 1043-22	DRAWN — KMM
PLOT SCALE = 1" = 50'	CHECKED - JB
PLAN DATE = 10/10/2023	

ANN ARBOR SPARK
CORRIDOR FIBER OPTIC BACKBONE PROJECT
ANN ARBOR
WASHTENAW COUNTY, MI

PERMITS REQUIRED:		
<input type="checkbox"/> CITY OF ANN ARBOR	<input checked="" type="checkbox"/> CITY OF YPSILANTI	<input type="checkbox"/> EGLE
<input checked="" type="checkbox"/> WASHTENAW COUNTY	<input checked="" type="checkbox"/> YPSILANTI TOWNSHIP	<input type="checkbox"/> RR
<input checked="" type="checkbox"/> WASHTENAW COUNTY DRAIN	<input checked="" type="checkbox"/> PITTSFIELD TOWNSHIP	<input checked="" type="checkbox"/> MDOT

SHEET INFORMATION	
TOTAL SHEETS	SHEET NO.
35	06

REVISION		
REV #	DATE	DESCRIPTION
01	07/13/23	REV BORE PATH SHTS 10-13 FOR CLEARANCE FROM DRAIN
02	08/01/23	ADD DEPTH NOTE SHT 12
03	09/06/23	REVISED PER WCRC.WCWR & PITTSFIELD TWP COMMENTS
04	10/10/23	REVISED PER WCRC COMMENTS

PITTSFIELD TOWNSHIP
SEC:12 T:03S R:06E

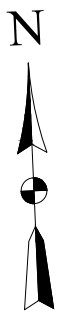
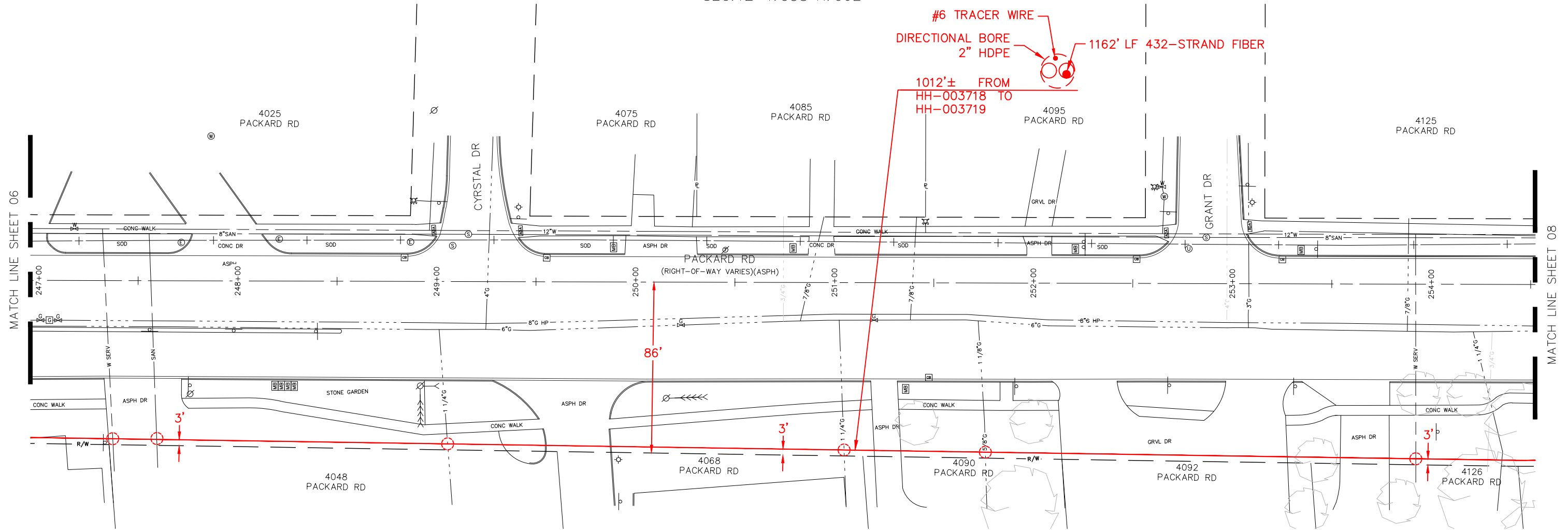

K:\2022\1043 JOB FOLDERS\1043-22-0321\DWG\1043-22-0321_DS.dwg: 10/10/2023 6:54 AM;



THE LOCATIONS OF EXISTING UNDERGROUND UTILITIES ARE SHOWN IN AN APPROXIMATE WAY ONLY AND HAVE NOT BEEN INDEPENDENTLY VERIFIED. THE CONTRACTOR SHALL DETERMINE THE EXACT LOCATION OF ALL EXISTING UTILITIES BEFORE COMMENCING WORK, AND AGREES TO BE FULLY RESPONSIBLE FOR ANY AND ALL DAMAGES WHICH MIGHT BE OCCASIONED BY THE CONTRACTOR'S FAILURE TO EXACTLY LOCATE AND PRESERVE ANY AND ALL UNDERGROUND UTILITIES.

REVISION		
REV #	DATE	DESCRIPTION
01	07/13/23	REV BORE PATH SHTS 10-13 FOR CLEARANCE FROM DRAIN
02	08/01/23	ADD DEPTH NOTE SHT 12
03	09/06/23	REVISED PER WCRC.WCWR & PITTSFIELD TWP COMMENTS
04	10/10/23	REVISED PER WCRC COMMENTS

METRO ENGINEERING SOLUTIONS
33900 SCHOOLCRAFT RD
LIVONIA, MICHIGAN 48150
PHONE: 734.483.1427 FAX: 734.483.3431
www.metroes.net

SOUTH ROUTE - EAST OF U.S. 23	
MES JOB# 1043-22	DRAWN — KMM
PLOT SCALE = 1" = 50'	CHECKED - JB
PLAN DATE = 10/10/2023	

ANN ARBOR SPARK
CORRIDOR FIBER OPTIC BACKBONE PROJECT
ANN ARBOR
WASHTENAW COUNTY, MI

PERMITS REQUIRED:		
<input type="checkbox"/> CITY OF ANN ARBOR	<input checked="" type="checkbox"/> CITY OF YPSILANTI	<input type="checkbox"/> EGLE
<input checked="" type="checkbox"/> WASHTENAW COUNTY	<input checked="" type="checkbox"/> YPSILANTI TOWNSHIP	<input type="checkbox"/> RR
<input checked="" type="checkbox"/> WASHTENAW COUNTY DRAIN	<input checked="" type="checkbox"/> PITTSFIELD TOWNSHIP	<input checked="" type="checkbox"/> MDOT

SHEET INFORMATION	
TOTAL SHEETS	SHEET NO.
35	07

PITTSFIELD TOWNSHIP
SEC:12 T:03S R:06E

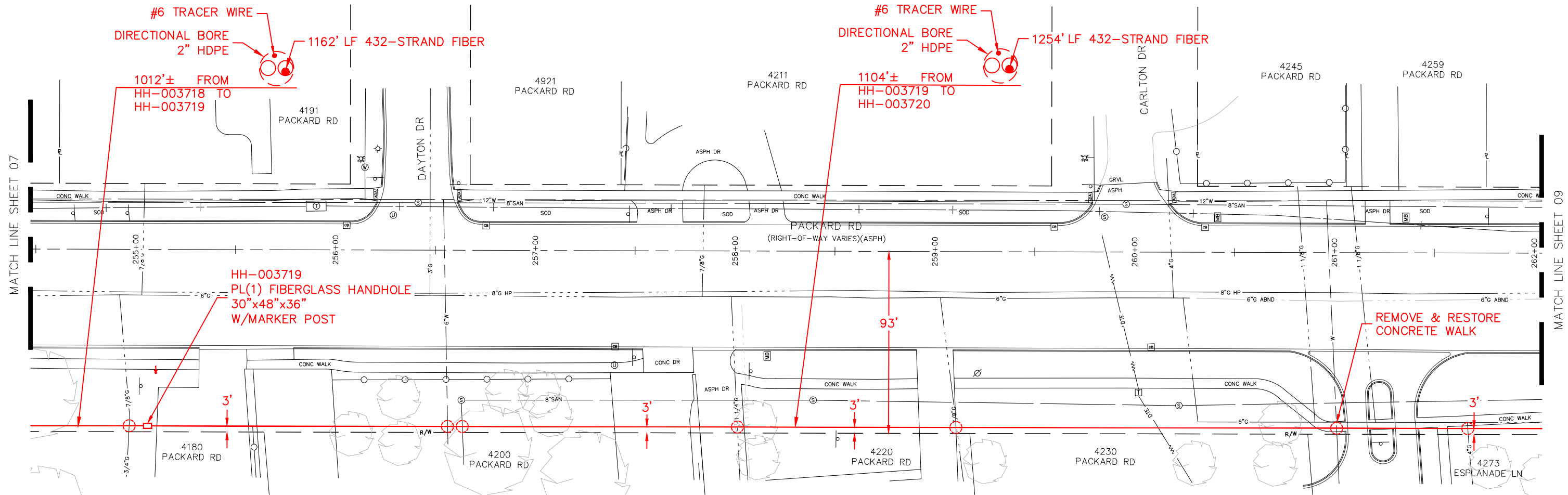

MATCH LINE SHEET 07

MATCH LINE SHEET 09

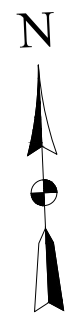

THE LOCATIONS OF EXISTING UNDERGROUND UTILITIES ARE SHOWN IN AN APPROXIMATE WAY ONLY AND HAVE NOT BEEN INDEPENDENTLY VERIFIED. THE CONTRACTOR SHALL DETERMINE THE EXACT LOCATION OF ALL EXISTING UTILITIES BEFORE COMMENCING WORK, AND AGREES TO BE FULLY RESPONSIBLE FOR ANY AND ALL DAMAGES WHICH MIGHT BE OCCASIONED BY THE CONTRACTOR'S FAILURE TO EXACTLY LOCATE AND PRESERVE ANY AND ALL UNDERGROUND UTILITIES.

REVISION		
REV #	DATE	DESCRIPTION
01	07/13/23	REV BORE PATH SHTS 10-13 FOR CLEARANCE FROM DRAIN
02	08/01/23	ADD DEPTH NOTE SHT 12
03	09/06/23	REVISED PER WCRC.WCWR & PITTSFIELD TWP COMMENTS
04	10/10/23	REVISED PER WCRC COMMENTS

METRO ENGINEERING SOLUTIONS
33900 SCHOOLCRAFT RD
LIVONIA, MICHIGAN 48150
PHONE: 734.483.1427 FAX: 734.483.3431
www.metroes.net

SOUTH ROUTE - EAST OF U.S. 23	
MES JOB# 1043-22	DRAWN — KMM
PLOT SCALE = 1" = 50'	CHECKED - JB
PLAN DATE = 10/10/2023	

ANN ARBOR SPARK
CORRIDOR FIBER OPTIC BACKBONE PROJECT
ANN ARBOR
WASHTENAW COUNTY, MI

PERMITS REQUIRED:		
<input type="checkbox"/> CITY OF ANN ARBOR	<input checked="" type="checkbox"/> CITY OF YPSILANTI	<input type="checkbox"/> EGLE
<input checked="" type="checkbox"/> WASHTENAW COUNTY	<input checked="" type="checkbox"/> YPSILANTI TOWNSHIP	<input type="checkbox"/> RR
<input checked="" type="checkbox"/> WASHTENAW COUNTY DRAIN	<input checked="" type="checkbox"/> PITTSFIELD TOWNSHIP	<input checked="" type="checkbox"/> MDOT

SHEET INFORMATION	
TOTAL SHEETS	SHEET NO.
35	08

K:\2022\1043 JOB FOLDERS\1043-22-0321\DWG\1043-22-0321_DS.dwg: 10/10/2023 6:54 AM;

PITTSFIELD TOWNSHIP
SEC:12 T:03S R:06E

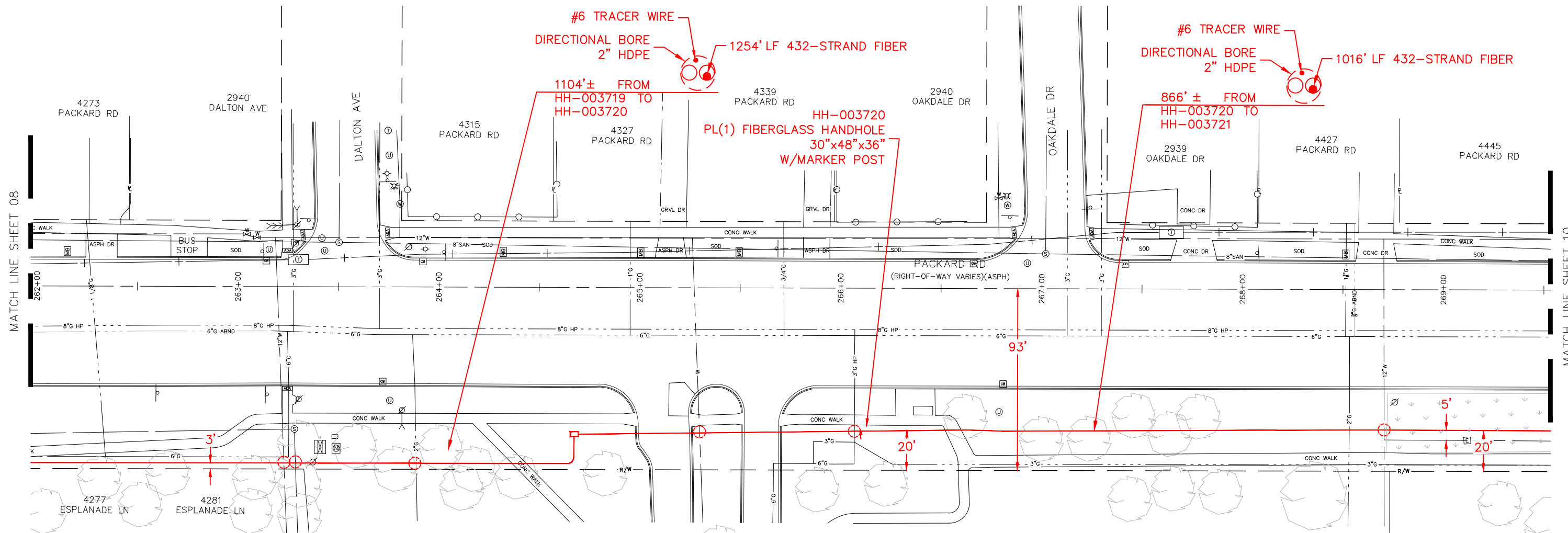

FUTURE RAIN GARDEN. ADDITIONAL DEPTH REQUIRED
INSTALL AT MINIMUM DEPTH OF 84" FOR CLEARANCE

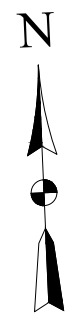

K:\2022\1043 JOB FOLDERS\1043-22-0321\DWG\1043-22-0321_DS.dwg: 10/10/2023 6:54 AM;



THE LOCATIONS OF EXISTING UNDERGROUND UTILITIES ARE SHOWN IN AN APPROXIMATE WAY ONLY AND HAVE NOT BEEN INDEPENDENTLY VERIFIED. THE CONTRACTOR SHALL DETERMINE THE EXACT LOCATION OF ALL EXISTING UTILITIES BEFORE COMMENCING WORK, AND AGREES TO BE FULLY RESPONSIBLE FOR ANY AND ALL DAMAGES WHICH MIGHT BE OCCASIONED BY THE CONTRACTOR'S FAILURE TO EXACTLY LOCATE AND PRESERVE ANY AND ALL UNDERGROUND UTILITIES.

METRO ENGINEERING SOLUTIONS
33900 SCHOOLCRAFT RD
LIVONIA, MICHIGAN 48150
PHONE: 734.483.1427 FAX: 734.483.3431
www.metroes.net

SOUTH ROUTE - EAST OF U.S. 23	
MES JOB# 1043-22	DRAWN — KMM
PLOT SCALE = 1" = 50'	CHECKED - JB
PLAN DATE = 10/10/2023	

ANN ARBOR SPARK
CORRIDOR FIBER OPTIC BACKBONE PROJECT
ANN ARBOR
WASHTENAW COUNTY, MI

PERMITS REQUIRED:		
<input type="checkbox"/> CITY OF ANN ARBOR	<input checked="" type="checkbox"/> CITY OF YPSILANTI	<input type="checkbox"/> EGLE
<input checked="" type="checkbox"/> WASHTENAW COUNTY	<input checked="" type="checkbox"/> YPSILANTI TOWNSHIP	<input type="checkbox"/> RR
<input checked="" type="checkbox"/> WASHTENAW COUNTY DRAIN	<input checked="" type="checkbox"/> PITTSFIELD TOWNSHIP	<input checked="" type="checkbox"/> MDOT

SHEET INFORMATION	
TOTAL SHEETS	SHEET NO.
35	09

REVISION		
REV #	DATE	DESCRIPTION
01	07/13/23	REV BORE PATH SHTS 10-13 FOR CLEARANCE FROM DRAIN
02	08/01/23	ADD DEPTH NOTE SHT 12
03	09/06/23	REVISED PER WCRC.WCWR & PITTSFIELD TWP COMMENTS
04	10/10/23	REVISED PER WCRC COMMENTS

PITTSFIELD TOWNSHIP
SEC:12 T:03S R:06E

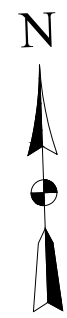
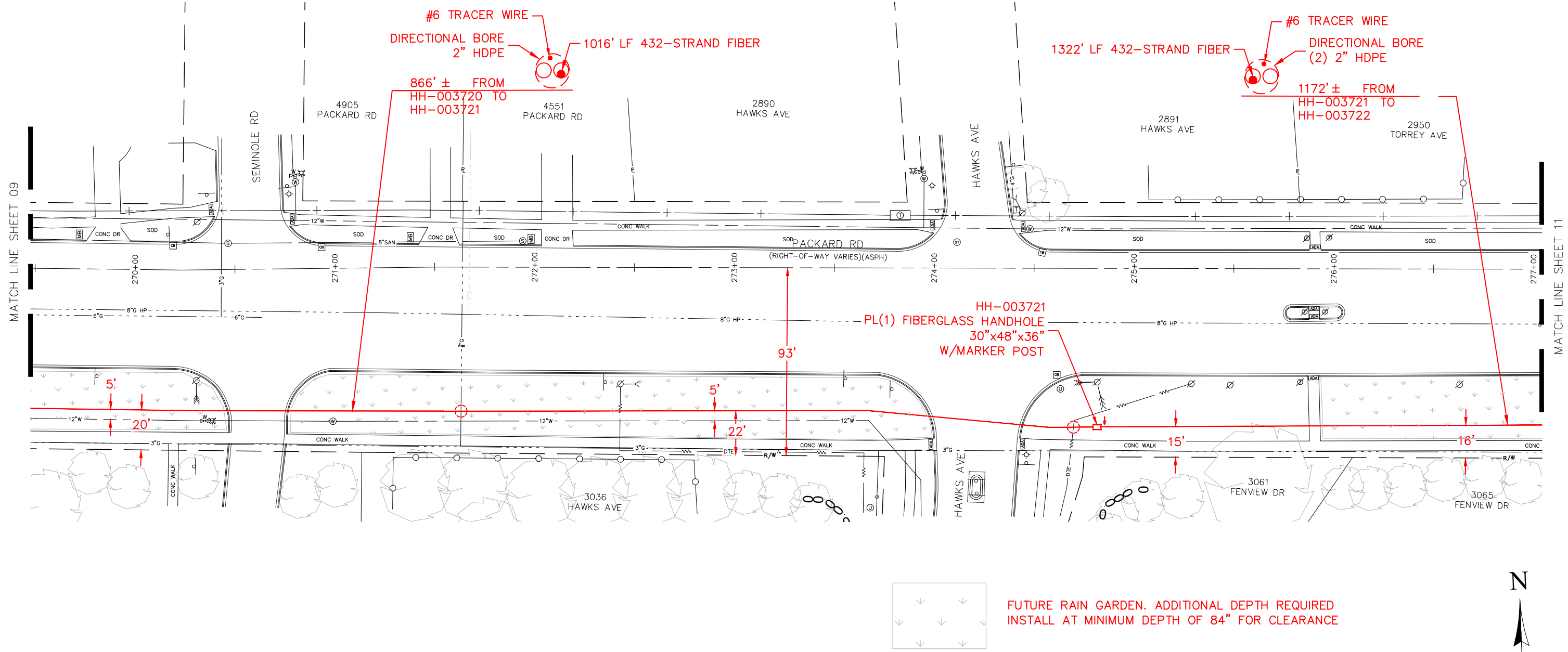

K:\2022\1043 JOB FOLDERS\1043-22-0321\DWG\1043-22-0321_DS.dwg: 10/10/2023 6:54 AM:



THE LOCATIONS OF EXISTING UNDERGROUND UTILITIES ARE SHOWN IN AN APPROXIMATE WAY ONLY AND HAVE NOT BEEN INDEPENDENTLY VERIFIED. THE CONTRACTOR SHALL DETERMINE THE EXACT LOCATION OF ALL EXISTING UTILITIES BEFORE COMMENCING WORK, AND AGREES TO BE FULLY RESPONSIBLE FOR ANY AND ALL DAMAGES WHICH MIGHT BE OCCASIONED BY THE CONTRACTOR'S FAILURE TO EXACTLY LOCATE AND PRESERVE ANY AND ALL UNDERGROUND UTILITIES.

METRO ENGINEERING SOLUTIONS
33900 SCHOOLCRAFT RD
LIVONIA, MICHIGAN 48150
PHONE: 734.483.1427 FAX: 734.483.3431
www.metroes.net

SOUTH ROUTE - EAST OF U.S. 23	
MES JOB# 1043-22	DRAWN - KMM
PLOT SCALE = 1" = 50'	CHECKED - JB
PLAN DATE = 10/10/2023	

ANN ARBOR SPARK
CORRIDOR FIBER OPTIC BACKBONE PROJECT
ANN ARBOR
WASHTENAW COUNTY, MI

PERMITS REQUIRED:		
<input type="checkbox"/> CITY OF ANN ARBOR	<input checked="" type="checkbox"/> CITY OF YPSILANTI	<input type="checkbox"/> EGLE
<input checked="" type="checkbox"/> WASHTENAW COUNTY	<input checked="" type="checkbox"/> YPSILANTI TOWNSHIP	<input type="checkbox"/> RR
<input checked="" type="checkbox"/> WASHTENAW COUNTY DRAIN	<input checked="" type="checkbox"/> PITTSFIELD TOWNSHIP	<input checked="" type="checkbox"/> MDOT

SHEET INFORMATION	
TOTAL SHEETS	SHEET NO.
35	10

REVISION		
REV #	DATE	DESCRIPTION
01	07/13/23	REV BORE PATH SHTS 10-13 FOR CLEARANCE FROM DRAIN
02	08/01/23	ADD DEPTH NOTE SHT 12
03	09/06/23	REVISED PER WCRC.WCWR & PITTSFIELD TWP COMMENTS
04	10/10/23	REVISED PER WCRC COMMENTS

PITTSFIELD TOWNSHIP
SEC:12 T:03S R:06E

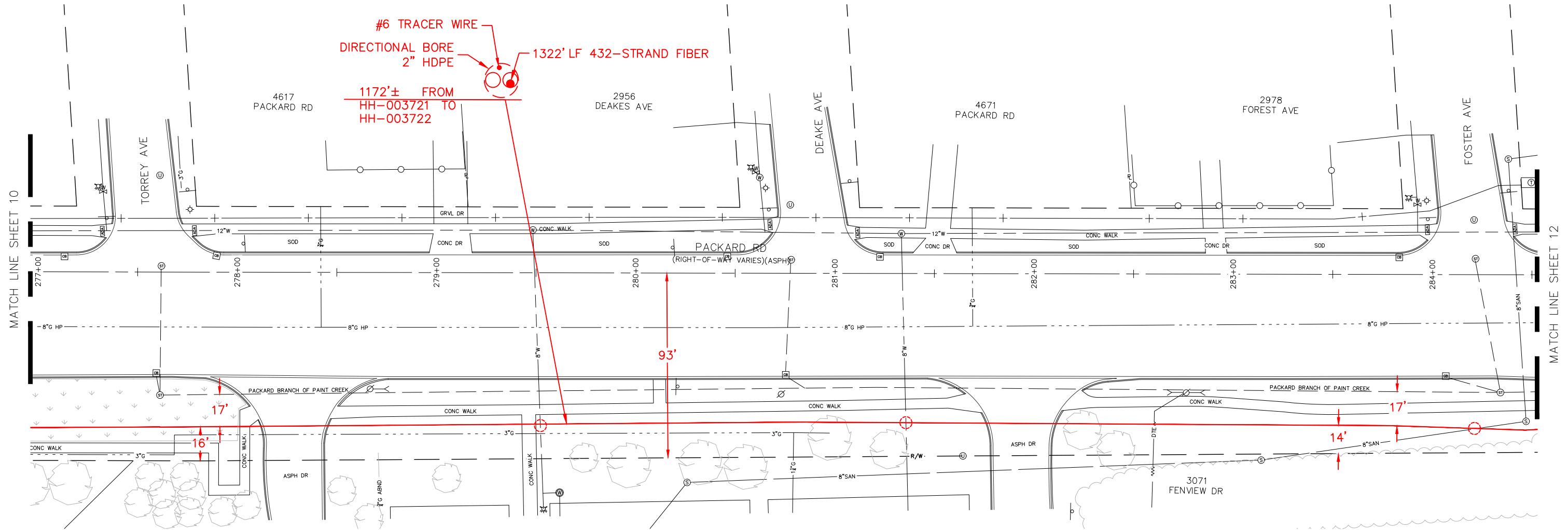

FUTURE RAIN GARDEN. ADDITIONAL DEPTH REQUIRED
INSTALL AT MINIMUM DEPTH OF 84" FOR CLEARANCE



K:\2022\1043 JOB FOLDERS\1043-22-0321\DWG\1043-22-0321_DS.dwg: 10/10/2023 6:54 AM;



THE LOCATIONS OF EXISTING UNDERGROUND UTILITIES ARE SHOWN IN AN APPROXIMATE WAY ONLY AND HAVE NOT BEEN INDEPENDENTLY VERIFIED. THE CONTRACTOR SHALL DETERMINE THE EXACT LOCATION OF ALL EXISTING UTILITIES BEFORE COMMENCING WORK, AND AGREES TO BE FULLY RESPONSIBLE FOR ANY AND ALL DAMAGES WHICH MIGHT BE OCCASIONED BY THE CONTRACTOR'S FAILURE TO EXACTLY LOCATE AND PRESERVE ANY AND ALL UNDERGROUND UTILITIES.

METRO ENGINEERING SOLUTIONS
33900 SCHOOLCRAFT RD
LIVONIA, MICHIGAN 48150
PHONE: 734.483.1427 FAX: 734.483.3431
www.metroes.net

SOUTH ROUTE - EAST OF U.S. 23	
MES JOB# 1043-22	DRAWN — KMM
PLOT SCALE = 1" = 50'	CHECKED - JB
PLAN DATE = 10/10/2023	

ANN ARBOR SPARK
CORRIDOR FIBER OPTIC BACKBONE PROJECT
ANN ARBOR
WASHTENAW COUNTY, MI

PERMITS REQUIRED:		
<input type="checkbox"/> CITY OF ANN ARBOR	<input checked="" type="checkbox"/> CITY OF YPSILANTI	<input type="checkbox"/> EGLE
<input checked="" type="checkbox"/> WASHTENAW COUNTY	<input checked="" type="checkbox"/> YPSILANTI TOWNSHIP	<input type="checkbox"/> RR
<input checked="" type="checkbox"/> WASHTENAW COUNTY DRAIN	<input checked="" type="checkbox"/> PITTSFIELD TOWNSHIP	<input checked="" type="checkbox"/> MDOT

SHEET INFORMATION	
TOTAL SHEETS	SHEET NO.
35	11

REVISION		
REV #	DATE	DESCRIPTION
01	07/13/23	REV BORE PATH SHTS 10-13 FOR CLEARANCE FROM DRAIN
02	08/01/23	ADD DEPTH NOTE SHT 12
03	09/06/23	REVISED PER WCRC.WCWR & PITTSFIELD TWP COMMENTS
04	10/10/23	REVISED PER WCRC COMMENTS

PITTSFIELD TOWNSHIP
SEC:12 T:03S R:06E

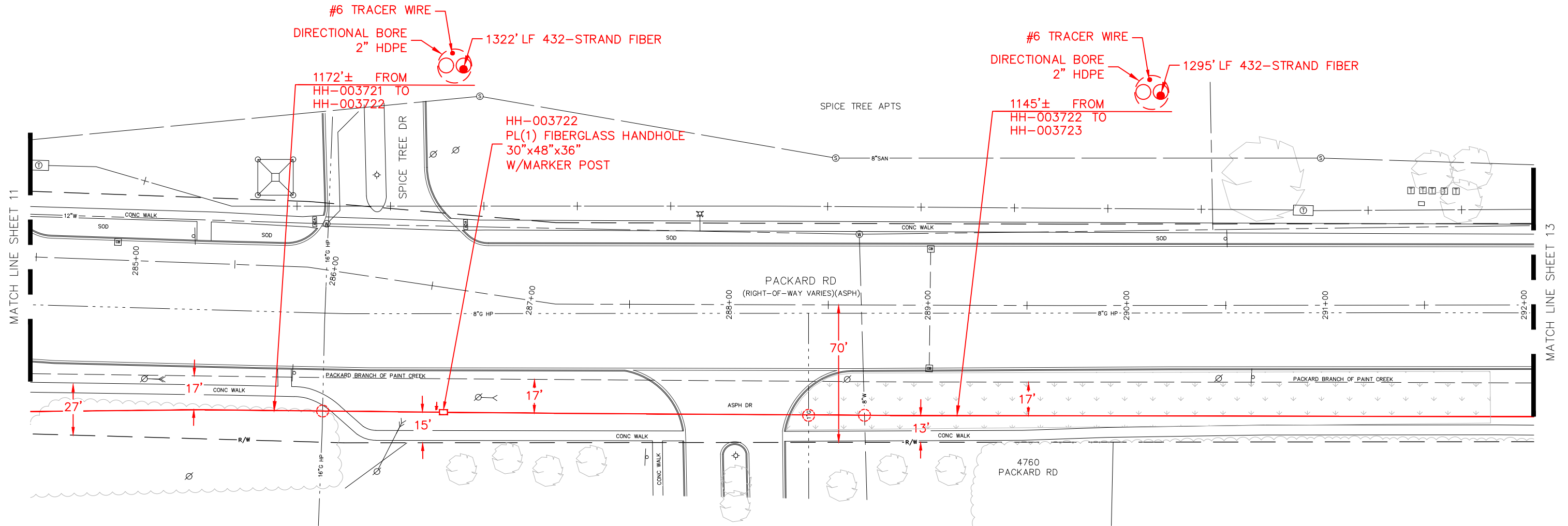

FUTURE RAIN GARDEN. ADDITIONAL DEPTH REQUIRED
INSTALL AT MINIMUM DEPTH OF 84" FOR CLEARANCE

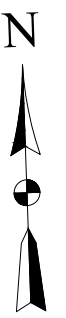

K:\2022\1043 JOB FOLDERS\1043-22-0321\DWG\1043-22-0321_DS.dwg: 10/10/2023 6:54 AM;



THE LOCATIONS OF EXISTING UNDERGROUND UTILITIES ARE SHOWN IN AN APPROXIMATE WAY ONLY AND HAVE NOT BEEN INDEPENDENTLY VERIFIED. THE CONTRACTOR SHALL DETERMINE THE EXACT LOCATION OF ALL EXISTING UTILITIES BEFORE COMMENCING WORK, AND AGREES TO BE FULLY RESPONSIBLE FOR ANY AND ALL DAMAGES WHICH MIGHT BE OCCASIONED BY THE CONTRACTOR'S FAILURE TO EXACTLY LOCATE AND PRESERVE ANY AND ALL UNDERGROUND UTILITIES.

METRO ENGINEERING SOLUTIONS
33900 SCHOOLCRAFT RD
LIVONIA, MICHIGAN 48150
PHONE: 734.483.1427 FAX: 734.483.3431
www.metroes.net

SOUTH ROUTE - EAST OF U.S. 23	
MES JOB# 1043-22	DRAWN — KMM
PLOT SCALE = 1" = 50'	CHECKED - JB
PLAN DATE = 10/10/2023	

ANN ARBOR SPARK
CORRIDOR FIBER OPTIC BACKBONE PROJECT
ANN ARBOR
WASHTENAW COUNTY, MI

PERMITS REQUIRED:		
<input type="checkbox"/> CITY OF ANN ARBOR	<input checked="" type="checkbox"/> CITY OF YPSILANTI	<input type="checkbox"/> EGLE
<input checked="" type="checkbox"/> WASHTENAW COUNTY	<input checked="" type="checkbox"/> YPSILANTI TOWNSHIP	<input type="checkbox"/> RR
<input checked="" type="checkbox"/> WASHTENAW COUNTY DRAIN	<input checked="" type="checkbox"/> PITTSFIELD TOWNSHIP	<input checked="" type="checkbox"/> MDOT

SHEET INFORMATION	
TOTAL SHEETS	SHEET NO.
35	12

REVISION		
REV #	DATE	DESCRIPTION
01	07/13/23	REV BORE PATH SHTS 10-13 FOR CLEARANCE FROM DRAIN
02	08/01/23	ADD DEPTH NOTE SHT 12
03	09/06/23	REVISED PER WCRC.WCWR & PITTSFIELD TWP COMMENTS
04	10/10/23	REVISED PER WCRC COMMENTS

PITTSFIELD TOWNSHIP
SEC:12 T:03S R:06E

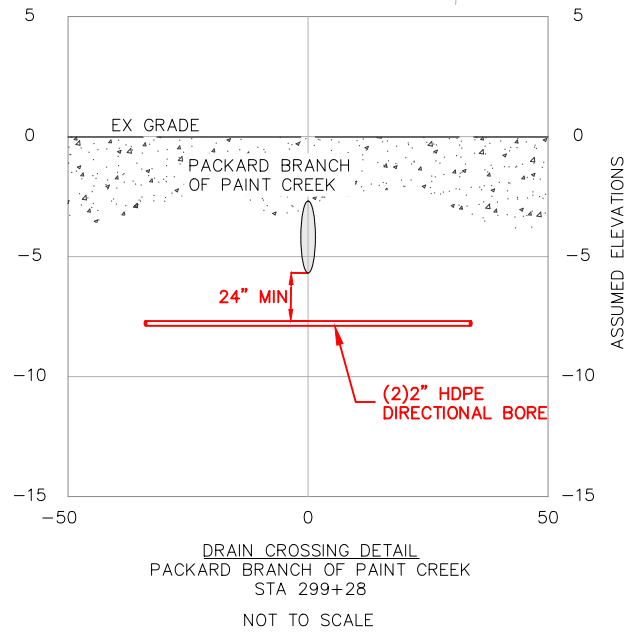
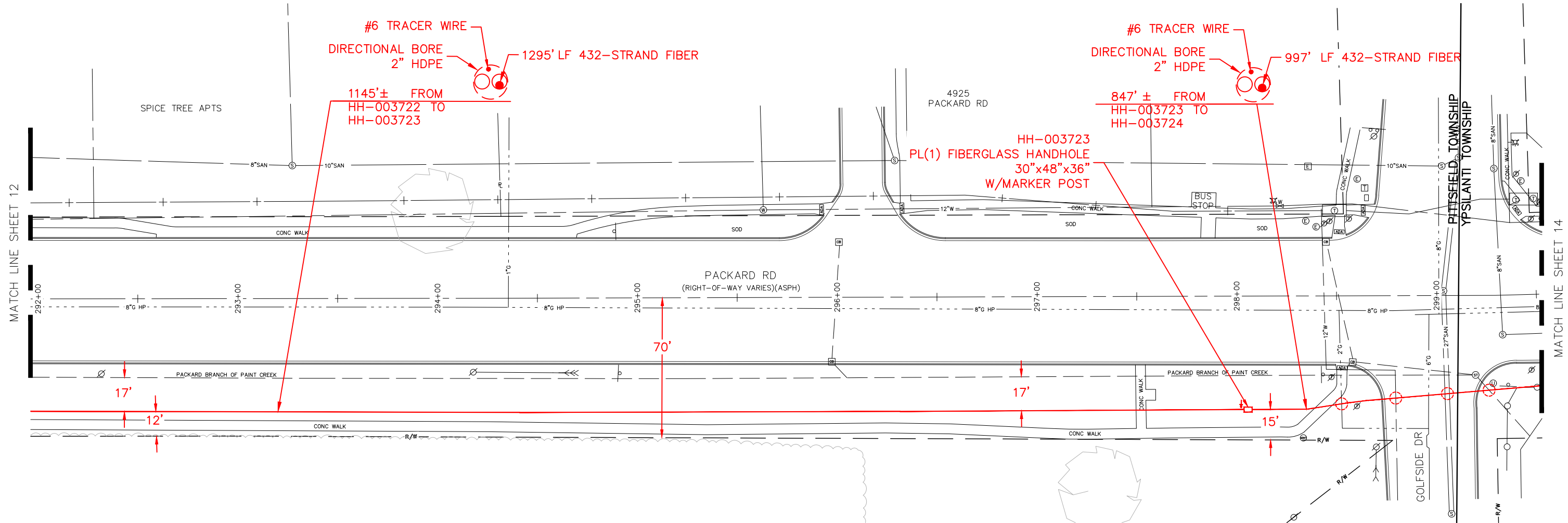

REVISION		
REV #	DATE	DESCRIPTION
01	07/13/23	REV BORE PATH SHTS 10-13 FOR CLEARANCE FROM DRAIN
02	08/01/23	ADD DEPTH NOTE SHT 12
03	09/06/23	REVISED PER WCRC.WCWR & PITTSFIELD TWP COMMENTS
04	10/10/23	REVISED PER WCRC COMMENTS



THE LOCATIONS OF EXISTING UNDERGROUND UTILITIES ARE SHOWN IN AN APPROXIMATE WAY ONLY AND HAVE NOT BEEN INDEPENDENTLY VERIFIED. THE CONTRACTOR SHALL DETERMINE THE EXACT LOCATION OF ALL EXISTING UTILITIES BEFORE COMMENCING WORK, AND AGREES TO BE FULLY RESPONSIBLE FOR ANY AND ALL DAMAGES WHICH MIGHT BE OCCASIONED BY THE CONTRACTOR'S FAILURE TO EXACTLY LOCATE AND PRESERVE ANY AND ALL UNDERGROUND UTILITIES.

METRO ENGINEERING SOLUTIONS
33900 SCHOOLCRAFT RD
LIVONIA, MICHIGAN 48150
PHONE: 734.483.1427 FAX: 734.483.3431
www.metroes.net

SOUTH ROUTE - EAST OF U.S. 23	
MES JOB# 1043-22	DRAWN - KMM
PLOT SCALE = 1" = 50'	CHECKED - JB
PLAN DATE = 10/10/2023	

ANN ARBOR SPARK
CORRIDOR FIBER OPTIC BACKBONE PROJECT
ANN ARBOR
WASHTENAW COUNTY, MI

PERMITS REQUIRED:		
<input type="checkbox"/> CITY OF ANN ARBOR	<input checked="" type="checkbox"/> CITY OF YPSILANTI	<input type="checkbox"/> EGLE
<input checked="" type="checkbox"/> WASHTENAW COUNTY	<input checked="" type="checkbox"/> YPSILANTI TOWNSHIP	<input type="checkbox"/> RR
<input checked="" type="checkbox"/> WASHTENAW COUNTY DRAIN	<input checked="" type="checkbox"/> PITTSFIELD TOWNSHIP	<input checked="" type="checkbox"/> MDOT

SHEET INFORMATION	
TOTAL SHEETS	SHEET NO.
35	13

K:\2022\1043 JOB FOLDERS\1043-22-0321\DWG\1043-22-0321_DS.dwg: 10/10/2023 6:54 AM:

YPSILANTI TOWNSHIP
SEC:07 T:03S R:07E

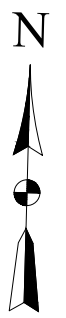
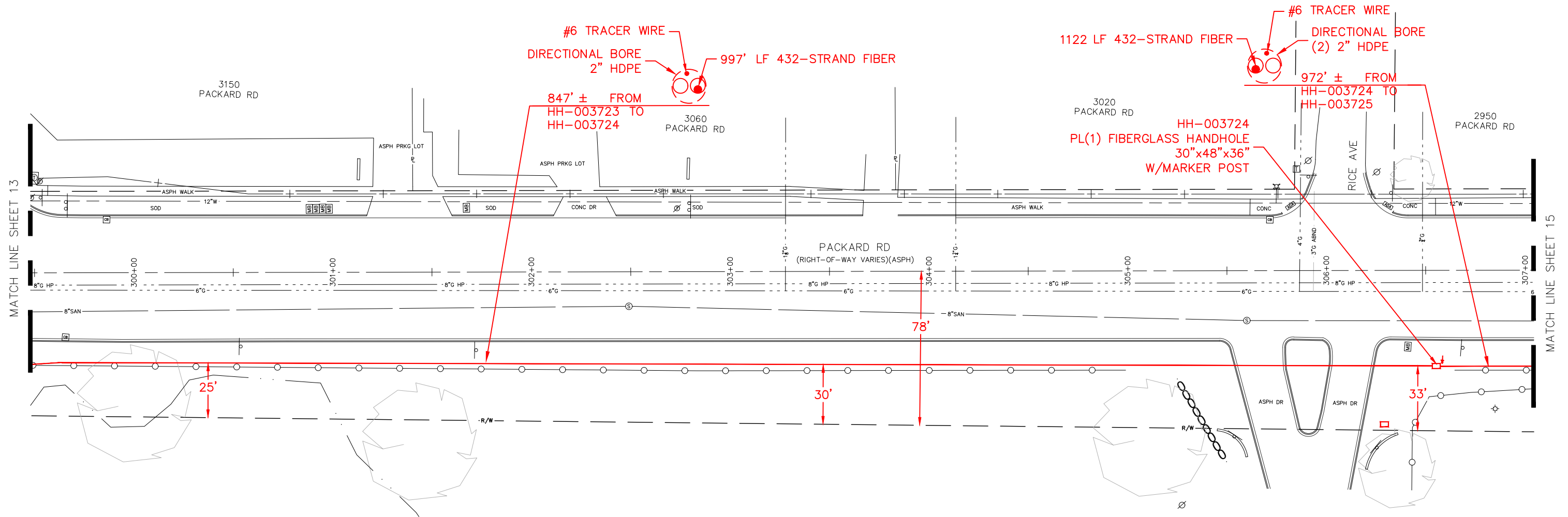

K:\2022\1043 JOB FOLDERS\1043-22-0321\DWG\1043-22-0321_DS.dwg: 10/10/2023 6:54 AM:



THE LOCATIONS OF EXISTING UNDERGROUND UTILITIES ARE SHOWN IN AN APPROXIMATE WAY ONLY AND HAVE NOT BEEN INDEPENDENTLY VERIFIED. THE CONTRACTOR SHALL DETERMINE THE EXACT LOCATION OF ALL EXISTING UTILITIES BEFORE COMMENCING WORK, AND AGREES TO BE FULLY RESPONSIBLE FOR ANY AND ALL DAMAGES WHICH MIGHT BE OCCASIONED BY THE CONTRACTOR'S FAILURE TO EXACTLY LOCATE AND PRESERVE ANY AND ALL UNDERGROUND UTILITIES.

REVISION		
REV #	DATE	DESCRIPTION
01	07/13/23	REV BORE PATH SHTS 10-13 FOR CLEARANCE FROM DRAIN
02	08/01/23	ADD DEPTH NOTE SHT 12
03	09/06/23	REVISED PER WCRC.WCWR & PITTSFIELD TWP COMMENTS
04	10/10/23	REVISED PER WCRC COMMENTS

METRO ENGINEERING SOLUTIONS
33900 SCHOOLCRAFT RD
LIVONIA, MICHIGAN 48150
PHONE: 734.483.1427 FAX: 734.483.3431
www.metroes.net

SOUTH ROUTE - EAST OF U.S. 23	
MES JOB# 1043-22	DRAWN — KMM
PLOT SCALE = 1" = 50'	CHECKED - JB
PLAN DATE = 10/10/2023	

ANN ARBOR SPARK
CORRIDOR FIBER OPTIC BACKBONE PROJECT
ANN ARBOR
WASHTENAW COUNTY, MI

PERMITS REQUIRED:		
<input type="checkbox"/> CITY OF ANN ARBOR	<input checked="" type="checkbox"/> CITY OF YPSILANTI	<input type="checkbox"/> EGLE
<input checked="" type="checkbox"/> WASHTENAW COUNTY	<input checked="" type="checkbox"/> YPSILANTI TOWNSHIP	<input type="checkbox"/> RR
<input checked="" type="checkbox"/> WASHTENAW COUNTY DRAIN	<input checked="" type="checkbox"/> PITTSFIELD TOWNSHIP	<input checked="" type="checkbox"/> MDOT

SHEET INFORMATION	
TOTAL SHEETS	SHEET NO.
35	14

YPSILANTI TOWNSHIP
SEC:07 T:03S R:07E

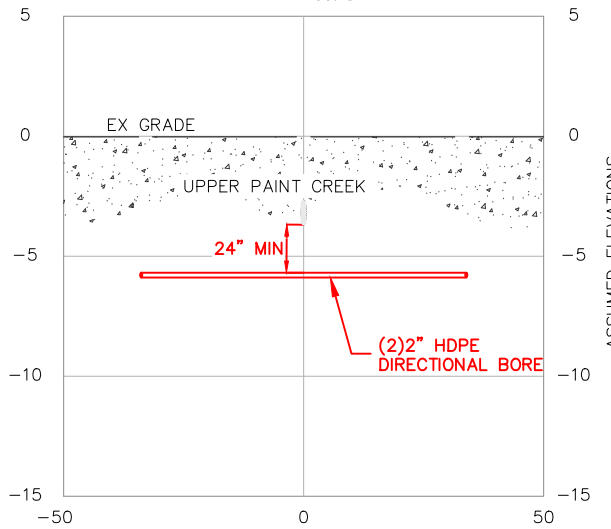
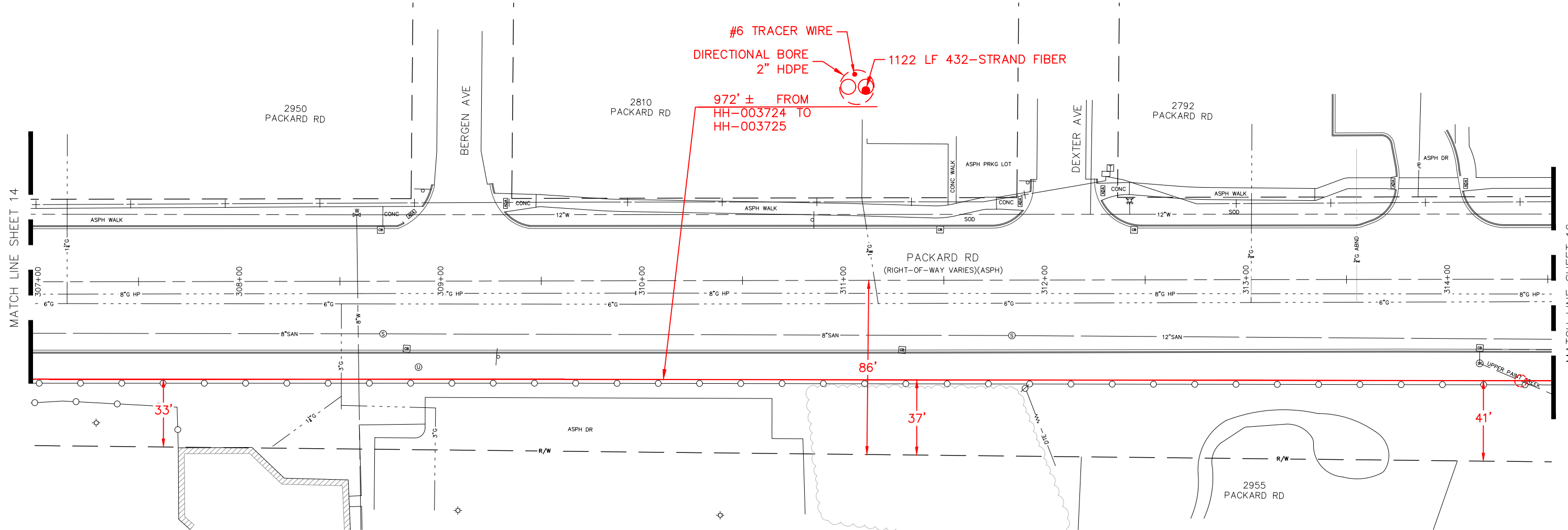

DRAIN CROSSING DETAIL
UPPER PAINT CREEK
STA 314+36
NOT TO SCALE

REVISION		
REV #	DATE	DESCRIPTION
01	07/13/23	REV BORE PATH SHTS 10-13 FOR CLEARANCE FROM DRAIN
02	08/01/23	ADD DEPTH NOTE SH12
03	09/06/23	REVISED PER WCRC.WCWRC & PITTSFIELD TWP COMMENTS
04	10/10/23	REVISED PER WCRC COMMENTS



THE LOCATIONS OF EXISTING UNDERGROUND UTILITIES ARE SHOWN IN AN APPROXIMATE WAY ONLY AND HAVE NOT BEEN INDEPENDENTLY VERIFIED. THE CONTRACTOR SHALL DETERMINE THE EXACT LOCATION OF ALL EXISTING UTILITIES BEFORE COMMENCING WORK, AND AGREES TO BE FULLY RESPONSIBLE FOR ANY AND ALL DAMAGES WHICH MIGHT BE OCCASIONED BY THE CONTRACTOR'S FAILURE TO EXACTLY LOCATE AND PRESERVE ANY AND ALL UNDERGROUND UTILITIES.

METRO ENGINEERING SOLUTIONS
33900 SCHOOLCRAFT RD
LIVONIA, MICHIGAN 48150
PHONE: 734.483.1427 FAX: 734.483.3431
www.metroes.net

SOUTH ROUTE - EAST OF U.S. 23	
MES JOB# 1043-22	DRAWN — KMM
PLOT SCALE = 1" = 50'	CHECKED — JB
PLAN DATE = 10/10/2023	

ANN ARBOR SPARK
CORRIDOR FIBER OPTIC BACKBONE PROJECT
ANN ARBOR
WASHTENAW COUNTY, MI

PERMITS REQUIRED:		
<input type="checkbox"/> CITY OF ANN ARBOR	<input checked="" type="checkbox"/> CITY OF YPSILANTI	<input type="checkbox"/> EGLE
<input checked="" type="checkbox"/> WASHTENAW COUNTY	<input checked="" type="checkbox"/> YPSILANTI TOWNSHIP	<input type="checkbox"/> RR
<input checked="" type="checkbox"/> WASHTENAW COUNTY DRAIN	<input checked="" type="checkbox"/> PITTSFIELD TOWNSHIP	<input checked="" type="checkbox"/> MDOT

SHEET INFORMATION	
TOTAL SHEETS	SHEET NO.
35	15

K:\2022\1043 JOB FOLDERS\1043-22-0321\DWG\1043-22-0321_DS.dwg: 10/10/2023 6:54 AM;

YPSILANTI TOWNSHIP
SEC:07 T:03S R:07E

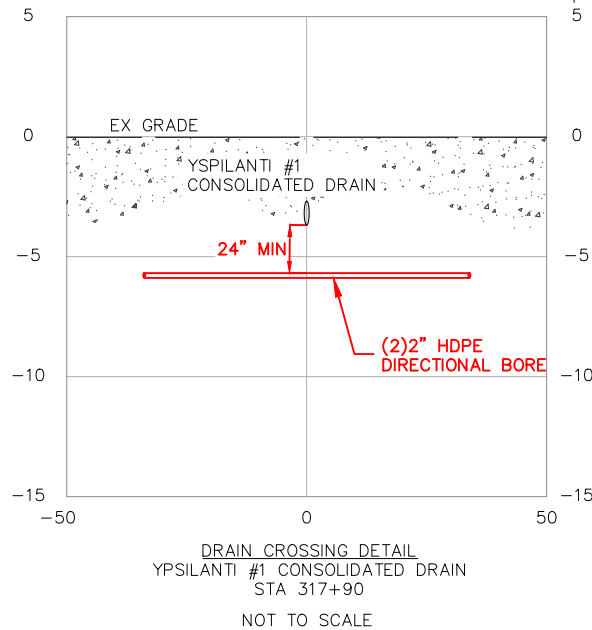
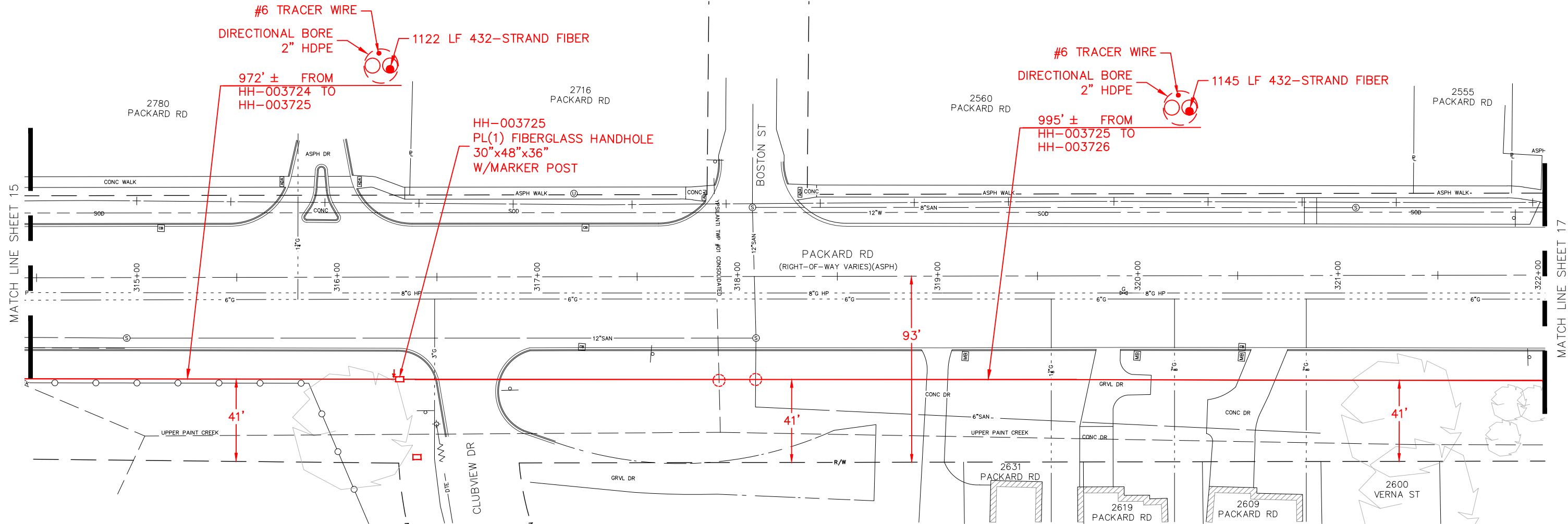

REVISION		
REV #	DATE	DESCRIPTION
01	07/13/23	REV BORE PATH SHTS 10-13 FOR CLEARANCE FROM DRAIN
02	08/01/23	ADD DEPTH NOTE SHT 12
03	09/06/23	REVISED PER WCRC.WCWR & PITTSFIELD TWP COMMENTS
04	10/10/23	REVISED PER WCRC COMMENTS



THE LOCATIONS OF EXISTING UNDERGROUND UTILITIES ARE SHOWN IN AN APPROXIMATE WAY ONLY AND HAVE NOT BEEN INDEPENDENTLY VERIFIED. THE CONTRACTOR SHALL DETERMINE THE EXACT LOCATION OF ALL EXISTING UTILITIES BEFORE COMMENCING WORK, AND AGREES TO BE FULLY RESPONSIBLE FOR ANY AND ALL DAMAGES WHICH MIGHT BE OCCASIONED BY THE CONTRACTOR'S FAILURE TO EXACTLY LOCATE AND PRESERVE ANY AND ALL UNDERGROUND UTILITIES.

METRO ENGINEERING SOLUTIONS
33900 SCHOOLCRAFT RD
LIVONIA, MICHIGAN 48150
PHONE: 734.483.1427 FAX: 734.483.3431
www.metroes.net

SOUTH ROUTE - EAST OF U.S. 23	
MES JOB# 1043-22	DRAWN — KMM
PLOT SCALE = 1" = 50'	CHECKED - JB
PLAN DATE = 10/10/2023	

ANN ARBOR SPARK
CORRIDOR FIBER OPTIC BACKBONE PROJECT
ANN ARBOR
WASHTENAW COUNTY, MI

PERMITS REQUIRED:		
<input type="checkbox"/> CITY OF ANN ARBOR	<input checked="" type="checkbox"/> CITY OF YPSILANTI	<input type="checkbox"/> EGLE
<input checked="" type="checkbox"/> WASHTENAW COUNTY	<input checked="" type="checkbox"/> YPSILANTI TOWNSHIP	<input type="checkbox"/> RR
<input checked="" type="checkbox"/> WASHTENAW COUNTY DRAIN	<input checked="" type="checkbox"/> PITTSFIELD TOWNSHIP	<input checked="" type="checkbox"/> MDOT

SHEET INFORMATION	
TOTAL SHEETS	SHEET NO.
35	16

K:\2022\1043 JOB FOLDERS\1043-22-0321\DWG\1043-22-0321_DS.dwg: 10/10/2023 6:54 AM:

YPSILANTI TOWNSHIP
SEC:07 T:03S R:07E

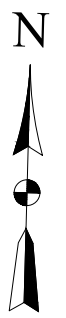
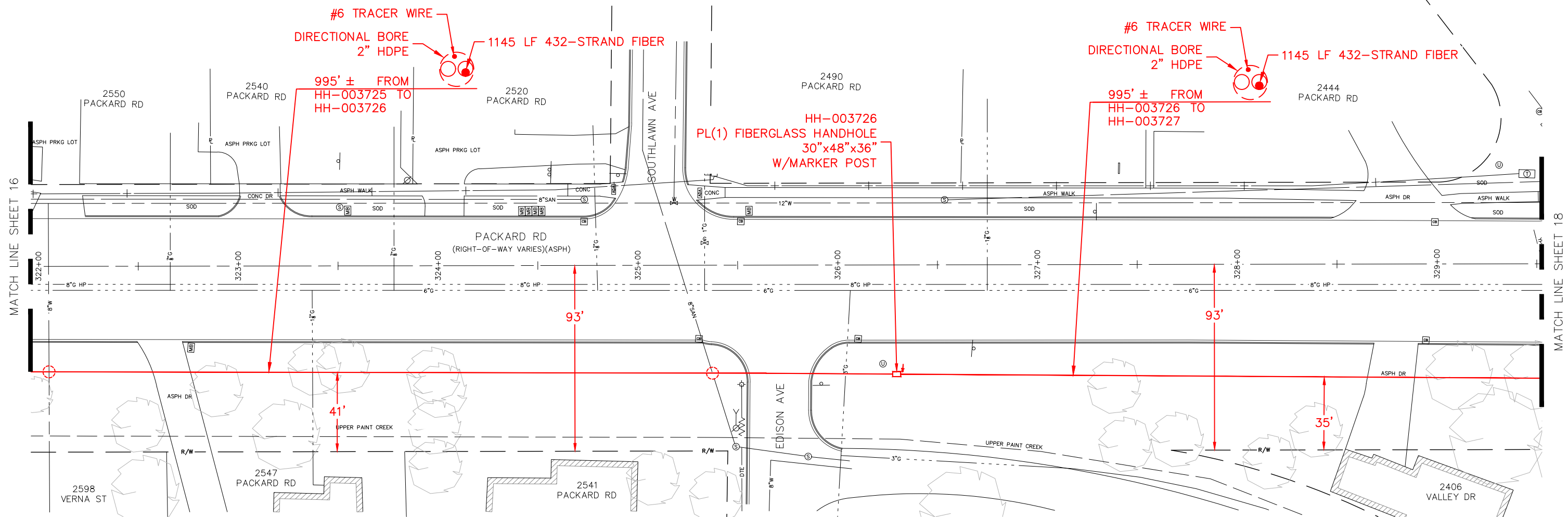

K:\2022\1043 JOB FOLDERS\1043-22-0321\DWG\1043-22-0321_DS.dwg: 10/10/2023 6:54 AM;



THE LOCATIONS OF EXISTING UNDERGROUND UTILITIES ARE SHOWN IN AN APPROXIMATE WAY ONLY AND HAVE NOT BEEN INDEPENDENTLY VERIFIED. THE CONTRACTOR SHALL DETERMINE THE EXACT LOCATION OF ALL EXISTING UTILITIES BEFORE COMMENCING WORK, AND AGREES TO BE FULLY RESPONSIBLE FOR ANY AND ALL DAMAGES WHICH MIGHT BE OCCASIONED BY THE CONTRACTOR'S FAILURE TO EXACTLY LOCATE AND PRESERVE ANY AND ALL UNDERGROUND UTILITIES.

REVISION		
REV #	DATE	DESCRIPTION
01	07/13/23	REV BORE PATH SHTS 10-13 FOR CLEARANCE FROM DRAIN
02	08/01/23	ADD DEPTH NOTE SHT 12
03	09/06/23	REVISED PER WCRC.WCWR & PITTSFIELD TWP COMMENTS
04	10/10/23	REVISED PER WCRC COMMENTS

METRO ENGINEERING SOLUTIONS
33900 SCHOOLCRAFT RD
LIVONIA, MICHIGAN 48150
PHONE: 734.483.1427 FAX: 734.483.3431
www.metroes.net

SOUTH ROUTE - EAST OF U.S. 23	
MES JOB# 1043-22	DRAWN — KMM
PLOT SCALE = 1" = 50'	CHECKED - JB
PLAN DATE = 10/10/2023	

ANN ARBOR SPARK
CORRIDOR FIBER OPTIC BACKBONE PROJECT
ANN ARBOR
WASHTENAW COUNTY, MI

PERMITS REQUIRED:		
<input type="checkbox"/> CITY OF ANN ARBOR	<input checked="" type="checkbox"/> CITY OF YPSILANTI	<input type="checkbox"/> EGLE
<input checked="" type="checkbox"/> WASHTENAW COUNTY	<input checked="" type="checkbox"/> YPSILANTI TOWNSHIP	<input type="checkbox"/> RR
<input checked="" type="checkbox"/> WASHTENAW COUNTY DRAIN	<input checked="" type="checkbox"/> PITTSFIELD TOWNSHIP	<input checked="" type="checkbox"/> MDOT

SHEET INFORMATION	
TOTAL SHEETS	SHEET NO.
35	17

YPSILANTI TOWNSHIP
SEC:07 T:03S R:07E

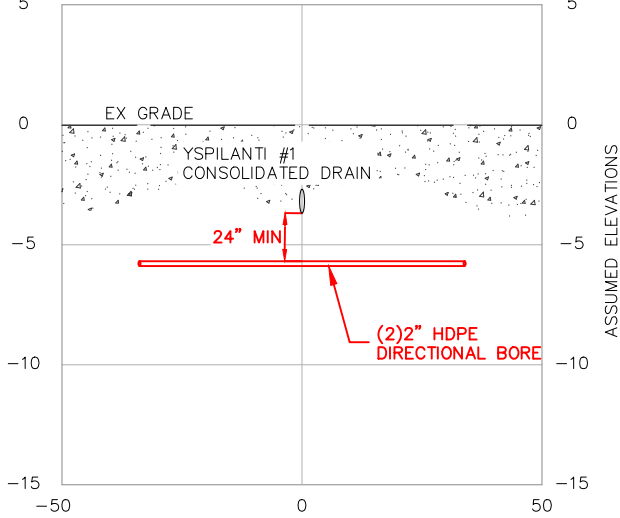
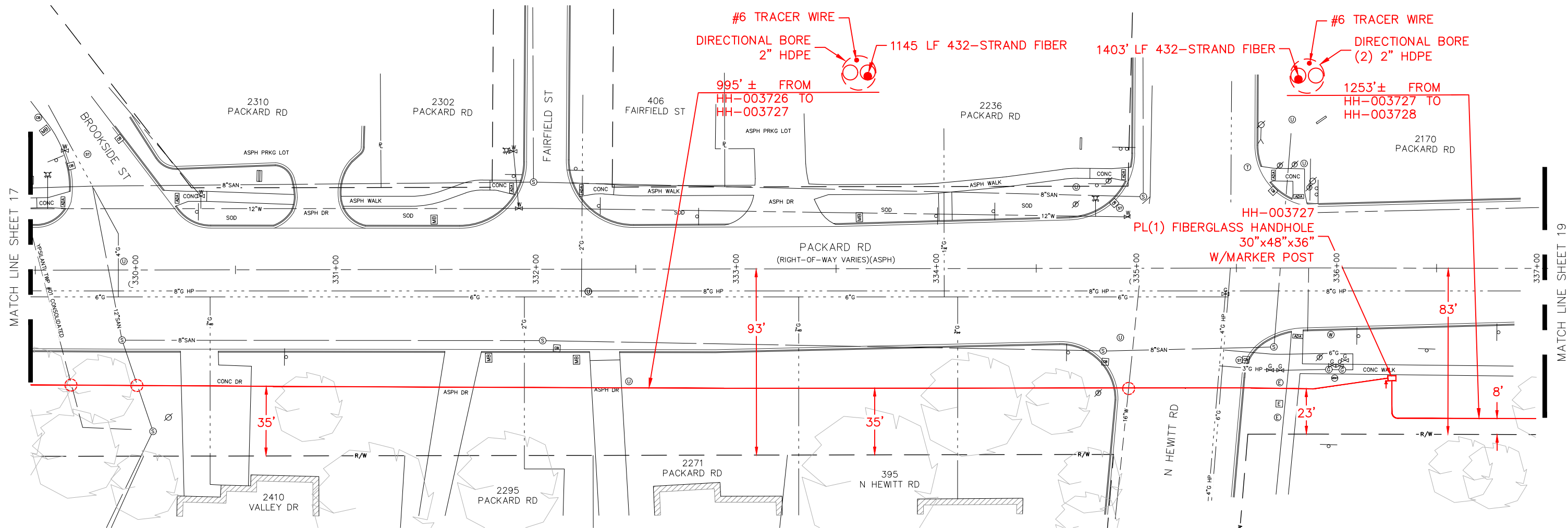

REVISION		
REV #	DATE	DESCRIPTION
01	07/13/23	REV BORE PATH SHTS 10-13 FOR CLEARANCE FROM DRAIN
02	08/01/23	ADD DEPTH NOTE SH12
03	09/06/23	REVISED PER WCRC.WCWR & PITTSFIELD TWP COMMENTS
04	10/10/23	REVISED PER WCRC COMMENTS



THE LOCATIONS OF EXISTING UNDERGROUND UTILITIES ARE SHOWN IN AN APPROXIMATE WAY ONLY AND HAVE NOT BEEN INDEPENDENTLY VERIFIED. THE CONTRACTOR SHALL DETERMINE THE EXACT LOCATION OF ALL EXISTING UTILITIES BEFORE COMMENCING WORK, AND AGREES TO BE FULLY RESPONSIBLE FOR ANY AND ALL DAMAGES WHICH MIGHT BE OCCASIONED BY THE CONTRACTOR'S FAILURE TO EXACTLY LOCATE AND PRESERVE ANY AND ALL UNDERGROUND UTILITIES.

METRO ENGINEERING SOLUTIONS
33900 SCHOOLCRAFT RD
LIVONIA, MICHIGAN 48150
PHONE: 734.483.1427 FAX: 734.483.3431
www.metroes.net

SOUTH ROUTE - EAST OF U.S. 23	
MES JOB# 1043-22	DRAWN - KMM
PLOT SCALE = 1" = 50'	CHECKED - JB
PLAN DATE = 10/10/2023	

ANN ARBOR SPARK
CORRIDOR FIBER OPTIC BACKBONE PROJECT
ANN ARBOR
WASHTENAW COUNTY, MI

PERMITS REQUIRED:		
<input type="checkbox"/> CITY OF ANN ARBOR	<input checked="" type="checkbox"/> CITY OF YPSILANTI	<input type="checkbox"/> EGLE
<input checked="" type="checkbox"/> WASHTENAW COUNTY	<input checked="" type="checkbox"/> YPSILANTI TOWNSHIP	<input type="checkbox"/> RR
<input checked="" type="checkbox"/> WASHTENAW COUNTY DRAIN	<input checked="" type="checkbox"/> PITTSFIELD TOWNSHIP	<input checked="" type="checkbox"/> MDOT

SHEET INFORMATION	
TOTAL SHEETS	SHEET NO.
35	18

K:\2022\1043 JOB FOLDERS\1043-22-0321\DWG\1043-22-0321_DS.dwg: 10/10/2023 6:54 AM;

YPSILANTI TOWNSHIP
SEC:07 T:03S R:07E

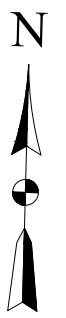
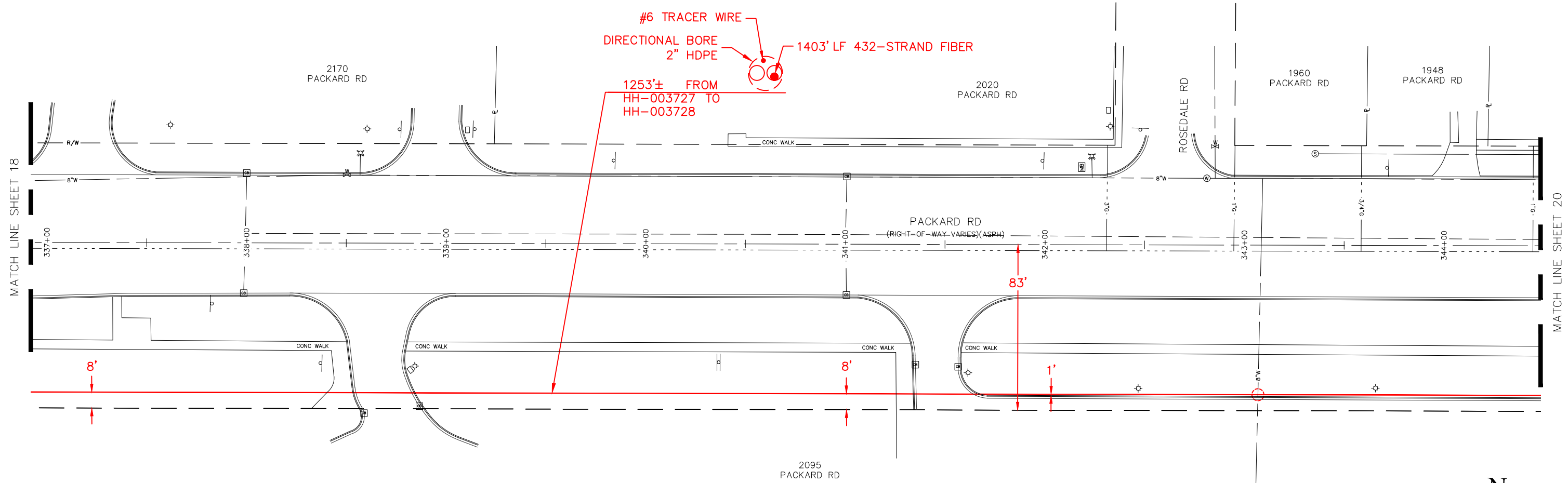

K:\2022\1043 JOB FOLDERS\1043-22-0322\DWG\1043-22-0322_DS.dwg; 10/10/2023 7:12 AM;



THE LOCATIONS OF EXISTING UNDERGROUND UTILITIES ARE SHOWN IN AN APPROXIMATE WAY ONLY AND HAVE NOT BEEN INDEPENDENTLY VERIFIED. THE CONTRACTOR SHALL DETERMINE THE EXACT LOCATION OF ALL EXISTING UTILITIES BEFORE COMMENCING WORK, AND AGREES TO BE FULLY RESPONSIBLE FOR ANY AND ALL DAMAGES WHICH MIGHT BE OCCASIONED BY THE CONTRACTOR'S FAILURE TO EXACTLY LOCATE AND PRESERVE ANY AND ALL UNDERGROUND UTILITIES.

REVISION		
REV #	DATE	DESCRIPTION
01	07/13/23	REV BORE PATH SHTS 10-13 FOR CLEARANCE FROM DRAIN
02	08/01/23	ADD DEPTH NOTE SHT 12
03	09/06/23	REVISED PER WCRC.WCWR & PITTSFIELD TWP COMMENTS
04	10/10/23	REVISED PER WCRC COMMENTS

METRO ENGINEERING SOLUTIONS
33900 SCHOOLCRAFT RD
LIVONIA, MICHIGAN 48150
PHONE: 734.483.1427 FAX: 734.483.3431
www.metroes.net

SOUTH ROUTE - EAST OF U.S. 23	
MES JOB# 1043-22	DRAWN — KMM
PLOT SCALE = 1" = 50'	CHECKED - JB
PLAN DATE = 10/10/2023	

ANN ARBOR SPARK
CORRIDOR FIBER OPTIC BACKBONE PROJECT
ANN ARBOR
WASHTENAW COUNTY, MI

PERMITS REQUIRED:		
<input type="checkbox"/> CITY OF ANN ARBOR	<input checked="" type="checkbox"/> CITY OF YPSILANTI	<input type="checkbox"/> EGLE
<input checked="" type="checkbox"/> WASHTENAW COUNTY	<input checked="" type="checkbox"/> YPSILANTI TOWNSHIP	<input type="checkbox"/> RR
<input checked="" type="checkbox"/> WASHTENAW COUNTY DRAIN	<input checked="" type="checkbox"/> PITTSFIELD TOWNSHIP	<input checked="" type="checkbox"/> MDOT

SHEET INFORMATION	
TOTAL SHEETS	SHEET NO.
35	19

YPSILANTI TOWNSHIP
SEC:07 T:03S R:07E

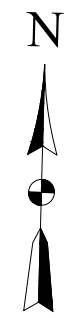
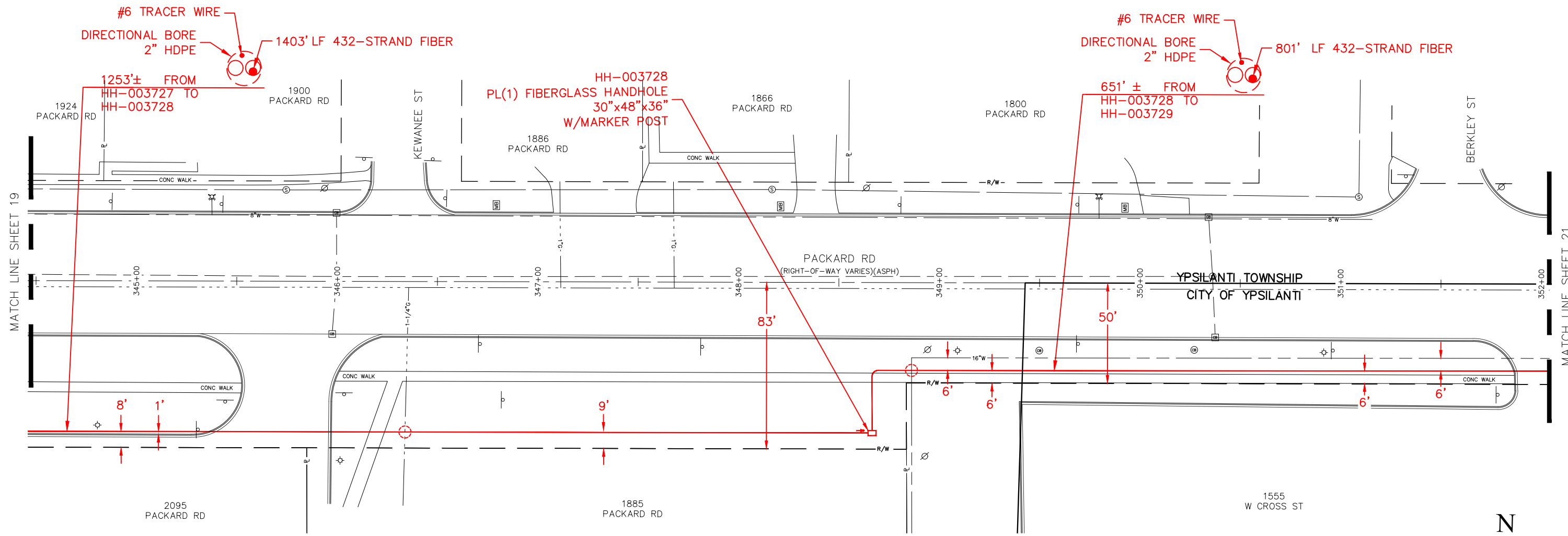

K:\2022\1043 JOB FOLDERS\1043-22-0322\DWG\1043-22-0322_DS.dwg; 10/10/2023 7:12 AM;



THE LOCATIONS OF EXISTING UNDERGROUND UTILITIES ARE SHOWN IN AN APPROXIMATE WAY ONLY AND HAVE NOT BEEN INDEPENDENTLY VERIFIED. THE CONTRACTOR SHALL DETERMINE THE EXACT LOCATION OF ALL EXISTING UTILITIES BEFORE COMMENCING WORK, AND AGREES TO BE FULLY RESPONSIBLE FOR ANY AND ALL DAMAGES WHICH MIGHT BE OCCASIONED BY THE CONTRACTOR'S FAILURE TO EXACTLY LOCATE AND PRESERVE ANY AND ALL UNDERGROUND UTILITIES.

REVISION		
REV #	DATE	DESCRIPTION
01	07/13/23	REV BORE PATH SHTS 10-13 FOR CLEARANCE FROM DRAIN
02	08/01/23	ADD DEPTH NOTE SHT 12
03	09/06/23	REVISED PER WCRC.WCWR & PITTSFIELD TWP COMMENTS
04	10/10/23	REVISED PER WCRC COMMENTS

METRO ENGINEERING SOLUTIONS
33900 SCHOOLCRAFT RD
LIVONIA, MICHIGAN 48150
PHONE: 734.483.1427 FAX: 734.483.3431
www.metroes.net

SOUTH ROUTE - EAST OF U.S. 23	
MES JOB# 1043-22	DRAWN — KMM
PLOT SCALE = 1" = 50'	CHECKED - JB
PLAN DATE = 10/10/2023	

ANN ARBOR SPARK
CORRIDOR FIBER OPTIC BACKBONE PROJECT
ANN ARBOR
WASHTENAW COUNTY, MI

PERMITS REQUIRED:		
<input type="checkbox"/> CITY OF ANN ARBOR	<input checked="" type="checkbox"/> CITY OF YPSILANTI	<input type="checkbox"/> EGLE
<input checked="" type="checkbox"/> WASHTENAW COUNTY	<input checked="" type="checkbox"/> YPSILANTI TOWNSHIP	<input type="checkbox"/> RR
<input checked="" type="checkbox"/> WASHTENAW COUNTY DRAIN	<input checked="" type="checkbox"/> PITTSFIELD TOWNSHIP	<input checked="" type="checkbox"/> MDOT

SHEET INFORMATION	
TOTAL SHEETS	SHEET NO.
35	20

CITY OF YPSILANTI
SEC:08 T:03S R:07E

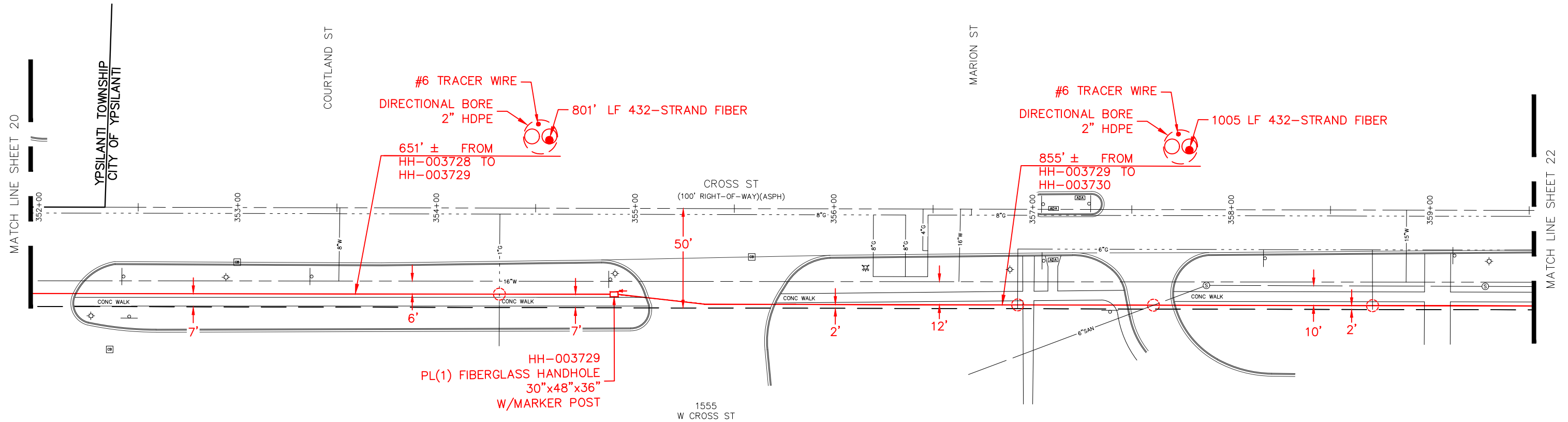

K:\2022\1043 JOB FOLDERS\1043-22-0322\DWG\1043-22-0322_DS.dwg; 10/10/2023 7:12 AM;



THE LOCATIONS OF EXISTING UNDERGROUND UTILITIES ARE SHOWN IN AN APPROXIMATE WAY ONLY AND HAVE NOT BEEN INDEPENDENTLY VERIFIED. THE CONTRACTOR SHALL DETERMINE THE EXACT LOCATION OF ALL EXISTING UTILITIES BEFORE COMMENCING WORK, AND AGREES TO BE FULLY RESPONSIBLE FOR ANY AND ALL DAMAGES WHICH MIGHT BE OCCASIONED BY THE CONTRACTOR'S FAILURE TO EXACTLY LOCATE AND PRESERVE ANY AND ALL UNDERGROUND UTILITIES.

REVISION		
REV #	DATE	DESCRIPTION
01	07/13/23	REV BORE PATH SHTS 10-13 FOR CLEARANCE FROM DRAIN
02	08/01/23	ADD DEPTH NOTE SHT 12
03	09/06/23	REVISED PER WCRC.WCWR & PITTSFIELD TWP COMMENTS
04	10/10/23	REVISED PER WCRC COMMENTS

METRO ENGINEERING SOLUTIONS
33900 SCHOOLCRAFT RD
LIVONIA, MICHIGAN 48150
PHONE: 734.483.1427 FAX: 734.483.3431
www.metroes.net

SOUTH ROUTE - EAST OF U.S. 23	
MES JOB# 1043-22	DRAWN — KMM
PLOT SCALE = 1" = 50'	CHECKED - JB
PLAN DATE = 10/10/2023	

ANN ARBOR SPARK
CORRIDOR FIBER OPTIC BACKBONE PROJECT
ANN ARBOR
WASHTENAW COUNTY, MI

PERMITS REQUIRED:		
<input type="checkbox"/> CITY OF ANN ARBOR	<input checked="" type="checkbox"/> CITY OF YPSILANTI	<input type="checkbox"/> EGLE
<input checked="" type="checkbox"/> WASHTENAW COUNTY	<input checked="" type="checkbox"/> YPSILANTI TOWNSHIP	<input type="checkbox"/> RR
<input checked="" type="checkbox"/> WASHTENAW COUNTY DRAIN	<input checked="" type="checkbox"/> PITTSFIELD TOWNSHIP	<input checked="" type="checkbox"/> MDOT

SHEET INFORMATION	
TOTAL SHEETS	SHEET NO.
35	21

CITY OF YPSILANTI
SEC:08 T:03S R:07E

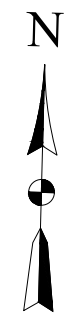
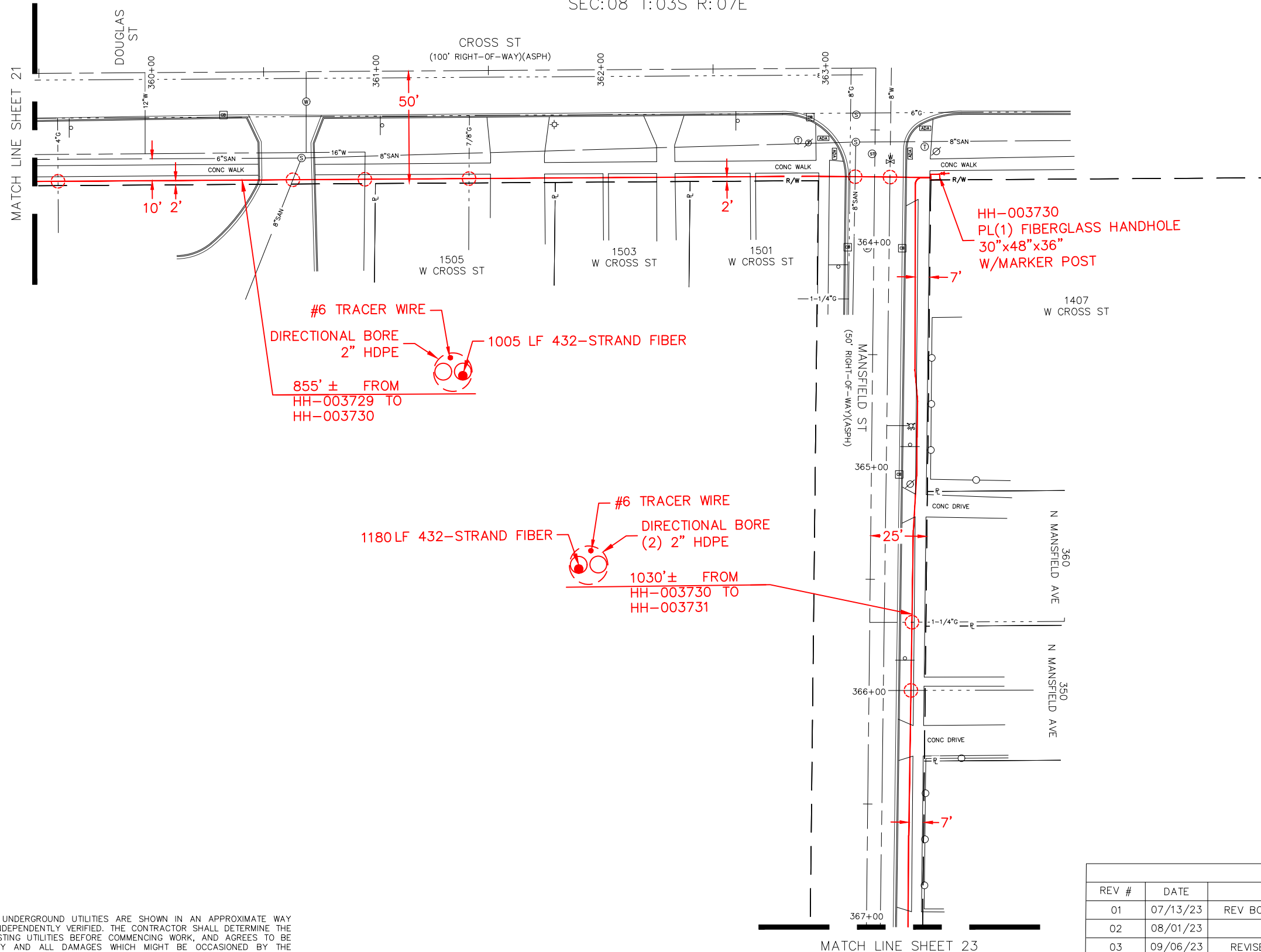

REVISION		
REV #	DATE	DESCRIPTION
01	07/13/23	REV BORE PATH SHTS 10-13 FOR CLEARANCE FROM DRAIN
02	08/01/23	ADD DEPTH NOTE SHT 12
03	09/06/23	REVISED PER WCRC.WCWR & PITTSFIELD TWP COMMENTS
04	10/10/23	REVISED PER WCRC COMMENTS



THE LOCATIONS OF EXISTING UNDERGROUND UTILITIES ARE SHOWN IN AN APPROXIMATE WAY ONLY AND HAVE NOT BEEN INDEPENDENTLY VERIFIED. THE CONTRACTOR SHALL DETERMINE THE EXACT LOCATION OF ALL EXISTING UTILITIES BEFORE COMMENCING WORK, AND AGREES TO BE FULLY RESPONSIBLE FOR ANY AND ALL DAMAGES WHICH MIGHT BE OCCASIONED BY THE CONTRACTOR'S FAILURE TO EXACTLY LOCATE AND PRESERVE ANY AND ALL UNDERGROUND UTILITIES.

METRO ENGINEERING SOLUTIONS
 33900 SCHOOLCRAFT RD
 LIVONIA, MICHIGAN 48150
 PHONE: 734.483.1427 FAX: 734.483.3431
 www.metroes.net

SOUTH ROUTE - EAST OF U.S. 23	
MES JOB# 1043-22	DRAWN — KMM
PLOT SCALE = 1" = 50'	CHECKED - JB
PLAN DATE = 10/10/2023	

ANN ARBOR SPARK
 CORRIDOR FIBER OPTIC BACKBONE PROJECT
 ANN ARBOR
 WASHTENAW COUNTY, MI

PERMITS REQUIRED:		
<input type="checkbox"/> CITY OF ANN ARBOR	<input checked="" type="checkbox"/> CITY OF YPSILANTI	<input type="checkbox"/> EGLE
<input checked="" type="checkbox"/> WASHTENAW COUNTY	<input checked="" type="checkbox"/> YPSILANTI TOWNSHIP	<input type="checkbox"/> RR
<input checked="" type="checkbox"/> WASHTENAW COUNTY DRAIN	<input checked="" type="checkbox"/> PITTSFIELD TOWNSHIP	<input checked="" type="checkbox"/> MDOT

SHEET INFORMATION	
TOTAL SHEETS	SHEET NO.
35	22

K:\2022\1043 JOB FOLDERS\1043-22-0322\DWG\1043-22-0322_DS.dwg; 10/10/2023 7:12 AM;

CITY OF YPSILANTI
SEC:08 T:03S R:07E

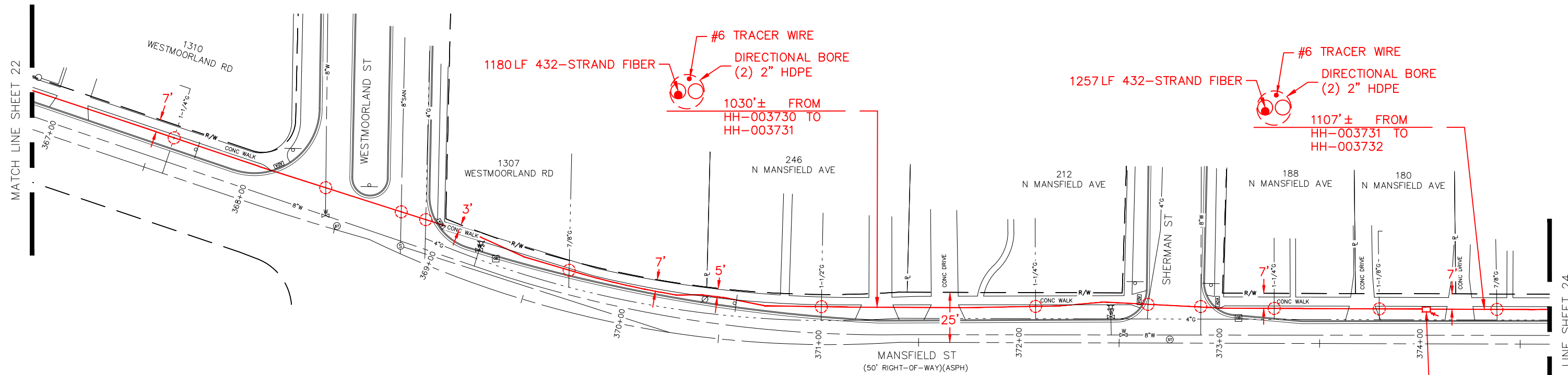

HH-003731
PL(1) FIBERGLASS HANDHOLE
30"x48"x36"
W/MARKER POST

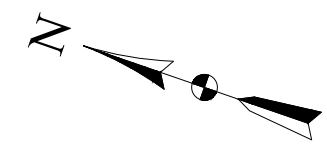

K:\2022\1043 JOB FOLDERS\1043-22-0322\DWG\1043-22-0322_DS.dwg; 10/10/2023 7:12 AM;



THE LOCATIONS OF EXISTING UNDERGROUND UTILITIES ARE SHOWN IN AN APPROXIMATE WAY ONLY AND HAVE NOT BEEN INDEPENDENTLY VERIFIED. THE CONTRACTOR SHALL DETERMINE THE EXACT LOCATION OF ALL EXISTING UTILITIES BEFORE COMMENCING WORK, AND AGREES TO BE FULLY RESPONSIBLE FOR ANY AND ALL DAMAGES WHICH MIGHT BE OCCASIONED BY THE CONTRACTOR'S FAILURE TO EXACTLY LOCATE AND PRESERVE ANY AND ALL UNDERGROUND UTILITIES.

REVISION		
REV #	DATE	DESCRIPTION
01	07/13/23	REV BORE PATH SHTS 10-13 FOR CLEARANCE FROM DRAIN
02	08/01/23	ADD DEPTH NOTE SHT 12
03	09/06/23	REVISED PER WCRC.WCWR & PITTSFIELD TWP COMMENTS
04	10/10/23	REVISED PER WCRC COMMENTS

METRO ENGINEERING SOLUTIONS
33900 SCHOOLCRAFT RD
LIVONIA, MICHIGAN 48150
PHONE: 734.483.1427 FAX: 734.483.3431
www.metroes.net

SOUTH ROUTE - EAST OF U.S. 23	
MES JOB# 1043-22	DRAWN — KMM
PLOT SCALE = 1" = 50'	CHECKED - JB
PLAN DATE = 10/10/2023	

ANN ARBOR SPARK
CORRIDOR FIBER OPTIC BACKBONE PROJECT
ANN ARBOR
WASHTENAW COUNTY, MI

PERMITS REQUIRED:		
<input type="checkbox"/> CITY OF ANN ARBOR	<input checked="" type="checkbox"/> CITY OF YPSILANTI	<input type="checkbox"/> EGLE
<input checked="" type="checkbox"/> WASHTENAW COUNTY	<input checked="" type="checkbox"/> YPSILANTI TOWNSHIP	<input type="checkbox"/> RR
<input checked="" type="checkbox"/> WASHTENAW COUNTY DRAIN	<input checked="" type="checkbox"/> PITTSFIELD TOWNSHIP	<input checked="" type="checkbox"/> MDOT

SHEET INFORMATION	
TOTAL SHEETS	SHEET NO.
35	23

CITY OF YPSILANTI
SEC:08 T:03S R:07E

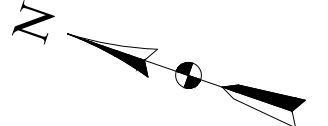
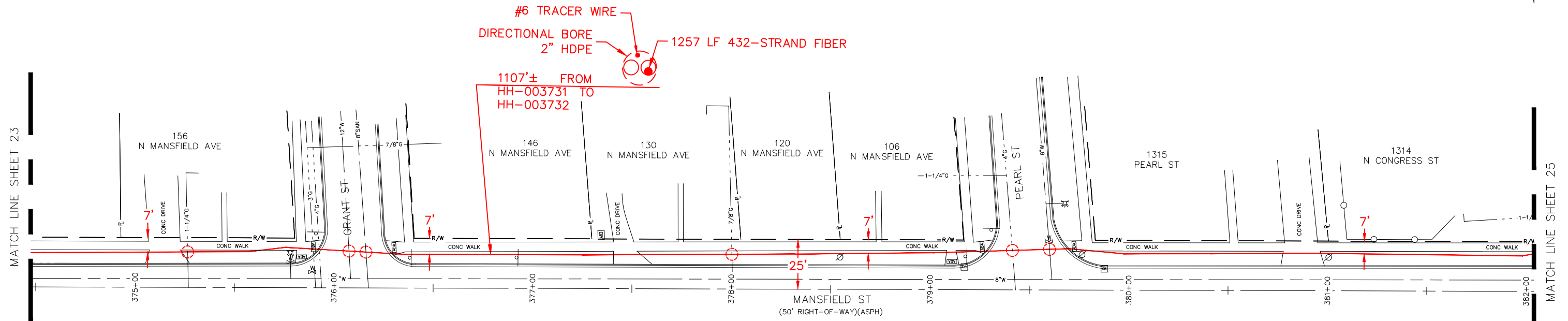

K:\2022\1043 JOB FOLDERS\1043-22-0322\DWG\1043-22-0322_DS.dwg; 10/10/2023 7:12 AM;



THE LOCATIONS OF EXISTING UNDERGROUND UTILITIES ARE SHOWN IN AN APPROXIMATE WAY ONLY AND HAVE NOT BEEN INDEPENDENTLY VERIFIED. THE CONTRACTOR SHALL DETERMINE THE EXACT LOCATION OF ALL EXISTING UTILITIES BEFORE COMMENCING WORK, AND AGREES TO BE FULLY RESPONSIBLE FOR ANY AND ALL DAMAGES WHICH MIGHT BE OCCASIONED BY THE CONTRACTOR'S FAILURE TO EXACTLY LOCATE AND PRESERVE ANY AND ALL UNDERGROUND UTILITIES.

REVISION		
REV #	DATE	DESCRIPTION
01	07/13/23	REV BORE PATH SHTS 10-13 FOR CLEARANCE FROM DRAIN
02	08/01/23	ADD DEPTH NOTE SHT 12
03	09/06/23	REVISED PER WCRC.WCWR & PITTSFIELD TWP COMMENTS
04	10/10/23	REVISED PER WCRC COMMENTS

METRO ENGINEERING SOLUTIONS
33900 SCHOOLCRAFT RD
LIVONIA, MICHIGAN 48150
PHONE: 734.483.1427 FAX: 734.483.3431
www.metroes.net

SOUTH ROUTE - EAST OF U.S. 23	
MES JOB# 1043-22	DRAWN — KMM
PLOT SCALE = 1" = 50'	CHECKED - JB
PLAN DATE = 10/10/2023	

ANN ARBOR SPARK
CORRIDOR FIBER OPTIC BACKBONE PROJECT
ANN ARBOR
WASHTENAW COUNTY, MI

PERMITS REQUIRED:		
<input type="checkbox"/> CITY OF ANN ARBOR	<input checked="" type="checkbox"/> CITY OF YPSILANTI	<input type="checkbox"/> EGLE
<input checked="" type="checkbox"/> WASHTENAW COUNTY	<input checked="" type="checkbox"/> YPSILANTI TOWNSHIP	<input type="checkbox"/> RR
<input checked="" type="checkbox"/> WASHTENAW COUNTY DRAIN	<input checked="" type="checkbox"/> PITTSFIELD TOWNSHIP	<input checked="" type="checkbox"/> MDOT

SHEET INFORMATION	
TOTAL SHEETS	SHEET NO.
35	24

CITY OF YPSILANTI
SEC:08 T:03S R:07E

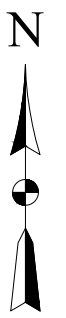
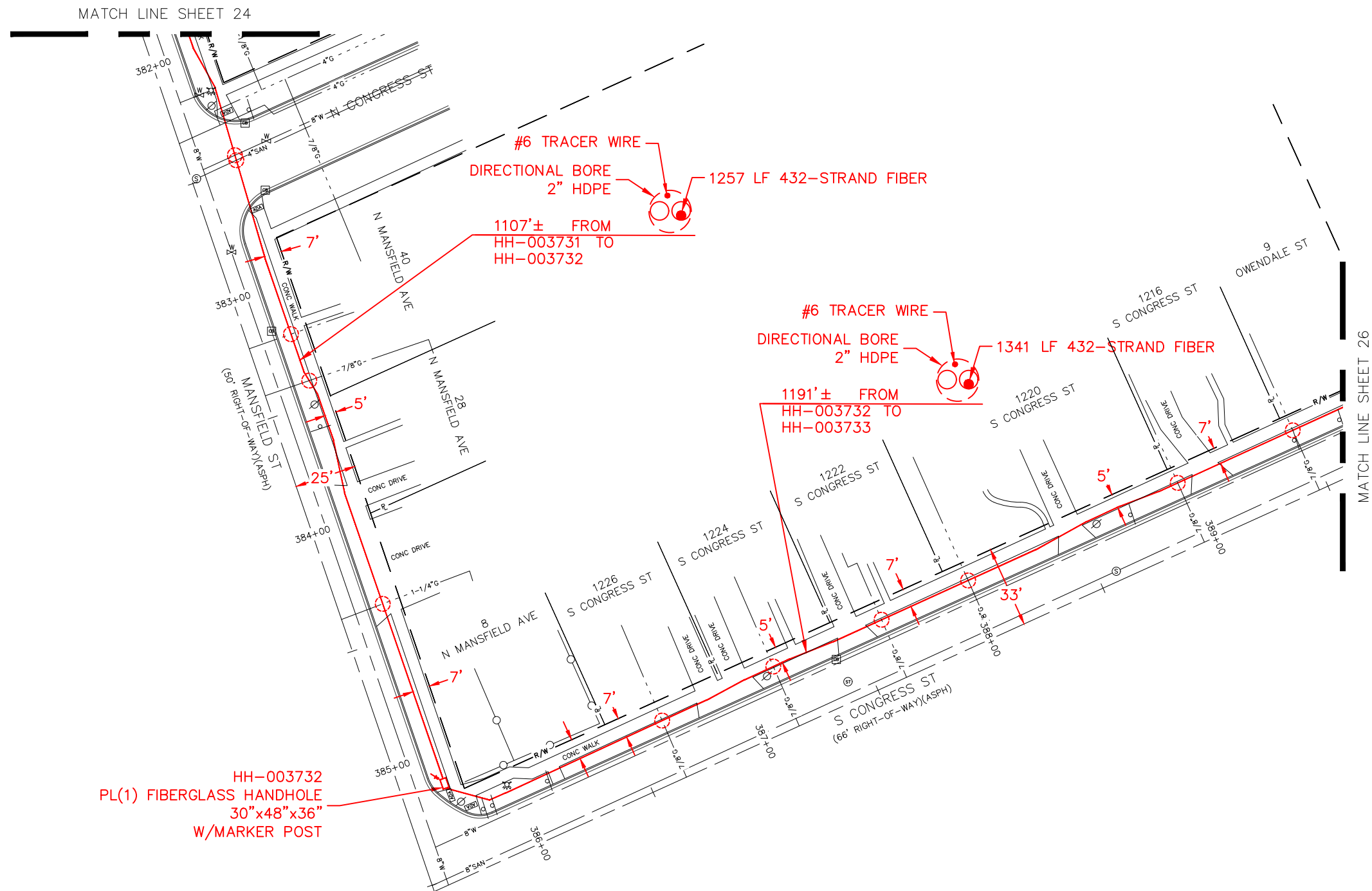

K:\2022\1043 JOB FOLDERS\1043-22-0322\DWG\1043-22-0322_DS.dwg; 10/10/2023 7:12 AM;



THE LOCATIONS OF EXISTING UNDERGROUND UTILITIES ARE SHOWN IN AN APPROXIMATE WAY ONLY AND HAVE NOT BEEN INDEPENDENTLY VERIFIED. THE CONTRACTOR SHALL DETERMINE THE EXACT LOCATION OF ALL EXISTING UTILITIES BEFORE COMMENCING WORK, AND AGREES TO BE FULLY RESPONSIBLE FOR ANY AND ALL DAMAGES WHICH MIGHT BE OCCASIONED BY THE CONTRACTOR'S FAILURE TO EXACTLY LOCATE AND PRESERVE ANY AND ALL UNDERGROUND UTILITIES.

METRO ENGINEERING SOLUTIONS
 33900 SCHOOLCRAFT RD
 LIVONIA, MICHIGAN 48150
 PHONE: 734.483.1427 FAX: 734.483.3431
 www.metroes.net

SOUTH ROUTE - EAST OF U.S. 23	
MES JOB# 1043-22	DRAWN — KMM
PLOT SCALE = 1" = 50'	CHECKED - JB
PLAN DATE = 10/10/2023	

ANN ARBOR SPARK
 CORRIDOR FIBER OPTIC BACKBONE PROJECT
 ANN ARBOR
 WASHTENAW COUNTY, MI

PERMITS REQUIRED:		
<input type="checkbox"/> CITY OF ANN ARBOR	<input checked="" type="checkbox"/> CITY OF YPSILANTI	<input type="checkbox"/> EGLE
<input checked="" type="checkbox"/> WASHTENAW COUNTY	<input checked="" type="checkbox"/> YPSILANTI TOWNSHIP	<input type="checkbox"/> RR
<input checked="" type="checkbox"/> WASHTENAW COUNTY DRAIN	<input checked="" type="checkbox"/> PITTSFIELD TOWNSHIP	<input checked="" type="checkbox"/> MDOT

SHEET INFORMATION	
TOTAL SHEETS	SHEET NO.
35	25

REVISION		
REV #	DATE	DESCRIPTION
01	07/13/23	REV BORE PATH SHTS 10-13 FOR CLEARANCE FROM DRAIN
02	08/01/23	ADD DEPTH NOTE SHT 12
03	09/06/23	REVISED PER WCRC.WCWRC & PITTSFIELD TWP COMMENTS
04	10/10/23	REVISED PER WCRC COMMENTS

CITY OF YPSILANTI
SEC:08 T:03S R:07E

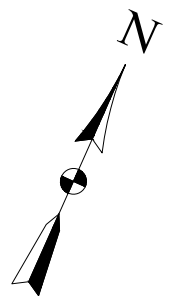
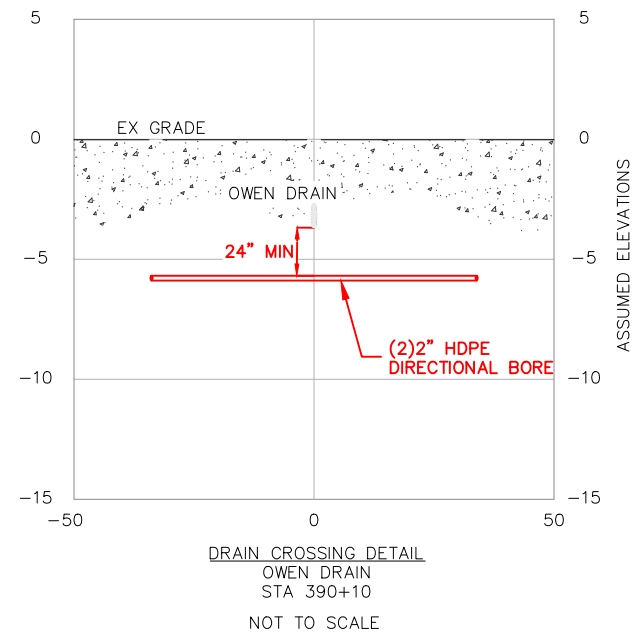
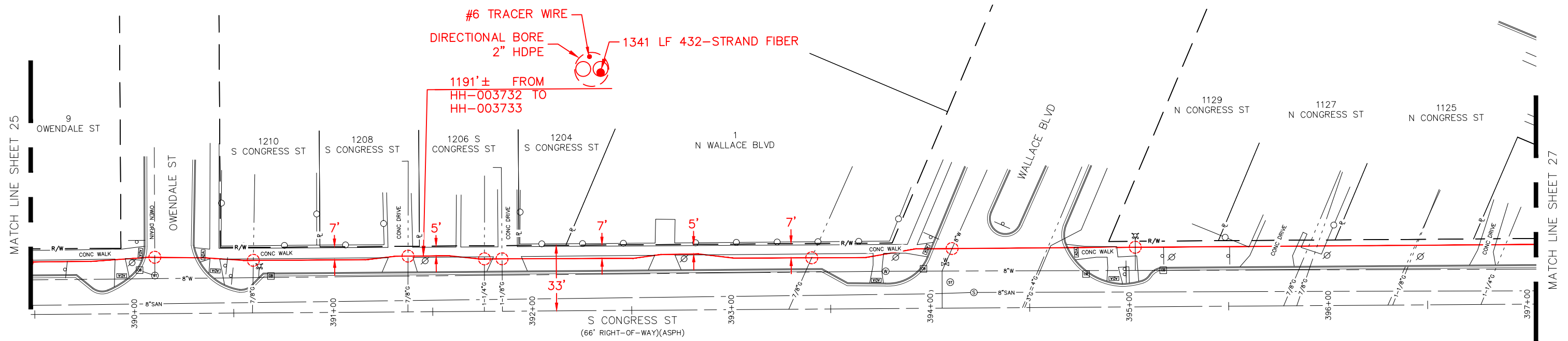

REVISION		
REV #	DATE	DESCRIPTION
01	07/13/23	REV BORE PATH SHTS 10-13 FOR CLEARANCE FROM DRAIN
02	08/01/23	ADD DEPTH NOTE SHT 12
03	09/06/23	REVISED PER WCRC.WCWR & PITTSFIELD TWP COMMENTS
04	10/10/23	REVISED PER WCRC COMMENTS



THE LOCATIONS OF EXISTING UNDERGROUND UTILITIES ARE SHOWN IN AN APPROXIMATE WAY ONLY AND HAVE NOT BEEN INDEPENDENTLY VERIFIED. THE CONTRACTOR SHALL DETERMINE THE EXACT LOCATION OF ALL EXISTING UTILITIES BEFORE COMMENCING WORK, AND AGREES TO BE FULLY RESPONSIBLE FOR ANY AND ALL DAMAGES WHICH MIGHT BE OCCASIONED BY THE CONTRACTOR'S FAILURE TO EXACTLY LOCATE AND PRESERVE ANY AND ALL UNDERGROUND UTILITIES.

METRO ENGINEERING SOLUTIONS
33900 SCHOOLCRAFT RD
LIVONIA, MICHIGAN 48150
PHONE: 734.483.1427 FAX: 734.483.3431
www.metroes.net

SOUTH ROUTE - EAST OF U.S. 23	
MES JOB# 1043-22	DRAWN — KMM
PLOT SCALE = 1" = 50'	CHECKED - JB
PLAN DATE = 10/10/2023	

ANN ARBOR SPARK
CORRIDOR FIBER OPTIC BACKBONE PROJECT
ANN ARBOR
WASHTENAW COUNTY, MI

PERMITS REQUIRED:		
<input type="checkbox"/> CITY OF ANN ARBOR	<input checked="" type="checkbox"/> CITY OF YPSILANTI	<input type="checkbox"/> EGLE
<input checked="" type="checkbox"/> WASHTENAW COUNTY	<input checked="" type="checkbox"/> YPSILANTI TOWNSHIP	<input type="checkbox"/> RR
<input checked="" type="checkbox"/> WASHTENAW COUNTY DRAIN	<input checked="" type="checkbox"/> PITTSFIELD TOWNSHIP	<input checked="" type="checkbox"/> MDOT

SHEET INFORMATION	
TOTAL SHEETS	SHEET NO.
35	26

K:\2022\1043 JOB FOLDERS\1043-22-0322\DWG\1043-22-0322_DS.dwg; 10/10/2023 7:12 AM;

CITY OF YPSILANTI
SEC:08 T:03S R:07E

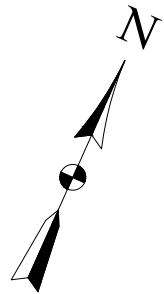
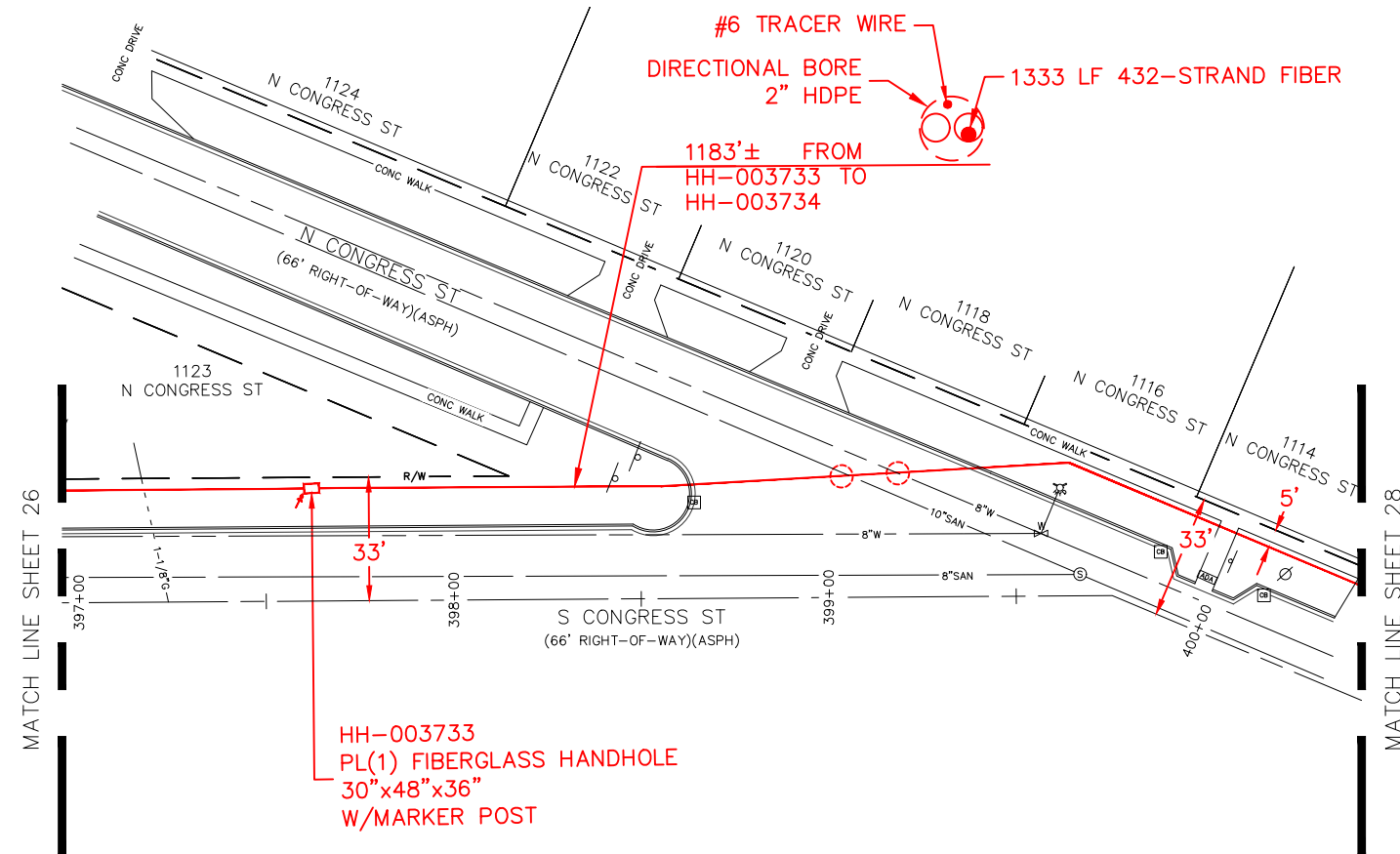

K:\2022\1043 JOB FOLDERS\1043-22-0322\DWG\1043-22-0322_DS.dwg; 10/10/2023 7:12 AM;



THE LOCATIONS OF EXISTING UNDERGROUND UTILITIES ARE SHOWN IN AN APPROXIMATE WAY ONLY AND HAVE NOT BEEN INDEPENDENTLY VERIFIED. THE CONTRACTOR SHALL DETERMINE THE EXACT LOCATION OF ALL EXISTING UTILITIES BEFORE COMMENCING WORK, AND AGREES TO BE FULLY RESPONSIBLE FOR ANY AND ALL DAMAGES WHICH MIGHT BE OCCASIONED BY THE CONTRACTOR'S FAILURE TO EXACTLY LOCATE AND PRESERVE ANY AND ALL UNDERGROUND UTILITIES.

REVISION		
REV #	DATE	DESCRIPTION
01	07/13/23	REV BORE PATH SHTS 10-13 FOR CLEARANCE FROM DRAIN
02	08/01/23	ADD DEPTH NOTE SHT 12
03	09/06/23	REVISED PER WCRC.WCWR & PITTSFIELD TWP COMMENTS
04	10/10/23	REVISED PER WCRC COMMENTS

METRO ENGINEERING SOLUTIONS
33900 SCHOOLCRAFT RD
LIVONIA, MICHIGAN 48150
PHONE: 734.483.1427 FAX: 734.483.3431
www.metroes.net

SOUTH ROUTE - EAST OF U.S. 23	
MES JOB# 1043-22	DRAWN — KMM
PLOT SCALE = 1" = 50'	CHECKED - JB
PLAN DATE = 10/10/2023	

ANN ARBOR SPARK
CORRIDOR FIBER OPTIC BACKBONE PROJECT
ANN ARBOR
WASHTENAW COUNTY, MI

PERMITS REQUIRED:		
<input type="checkbox"/> CITY OF ANN ARBOR	<input checked="" type="checkbox"/> CITY OF YPSILANTI	<input type="checkbox"/> EGLE
<input checked="" type="checkbox"/> WASHTENAW COUNTY	<input checked="" type="checkbox"/> YPSILANTI TOWNSHIP	<input type="checkbox"/> RR
<input checked="" type="checkbox"/> WASHTENAW COUNTY DRAIN	<input checked="" type="checkbox"/> PITTSFIELD TOWNSHIP	<input checked="" type="checkbox"/> MDOT

SHEET INFORMATION	
TOTAL SHEETS	SHEET NO.
35	27

CITY OF YPSILANTI
SEC:08 T:03S R:07E

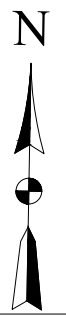
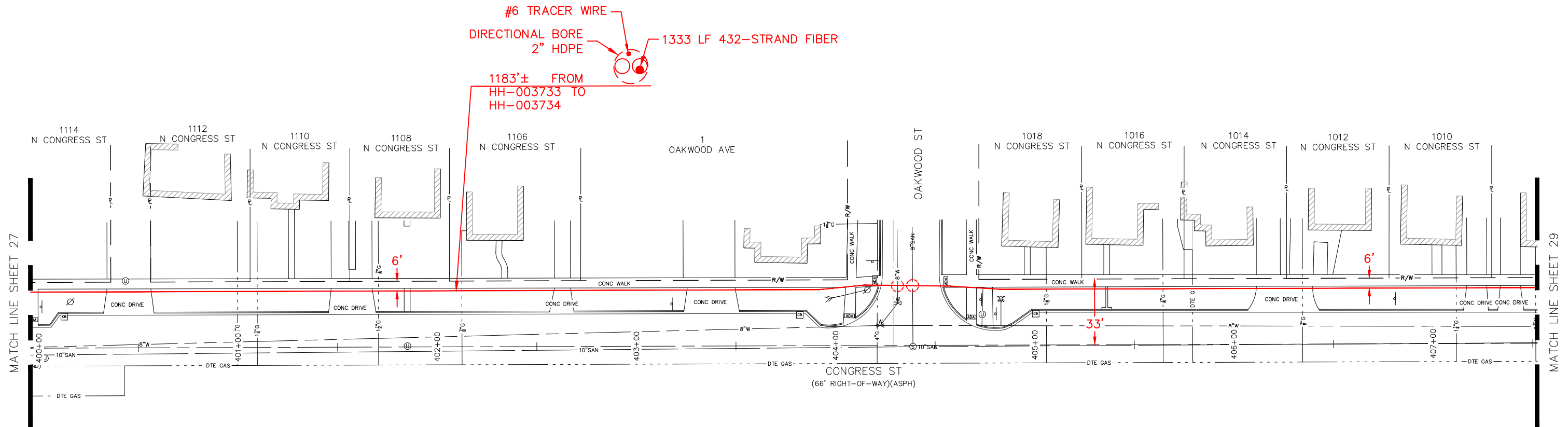

K:\2022\1043 JOB FOLDERS\1043-22-0323\DWG\1043-22-0323_DS.dwg; 6/6/2023 2:21 PM;



THE LOCATIONS OF EXISTING UNDERGROUND UTILITIES ARE SHOWN IN AN APPROXIMATE WAY ONLY AND HAVE NOT BEEN INDEPENDENTLY VERIFIED. THE CONTRACTOR SHALL DETERMINE THE EXACT LOCATION OF ALL EXISTING UTILITIES BEFORE COMMENCING WORK, AND AGREES TO BE FULLY RESPONSIBLE FOR ANY AND ALL DAMAGES WHICH MIGHT BE OCCASIONED BY THE CONTRACTOR'S FAILURE TO EXACTLY LOCATE AND PRESERVE ANY AND ALL UNDERGROUND UTILITIES.

METRO ENGINEERING SOLUTIONS
33900 SCHOOLCRAFT RD
LIVONIA, MICHIGAN 48150
PHONE: 734.483.1427 FAX: 734.483.3431
www.metroes.net

SOUTH ROUTE - EAST OF U.S. 23	
MES JOB# 1043-22	DRAWN — KMM
PLOT SCALE = 1" = 50'	CHECKED — JB
PLAN DATE = 6/6/2023	

ANN ARBOR SPARK
CORRIDOR FIBER OPTIC BACKBONE PROJECT
ANN ARBOR
WASHTENAW COUNTY, MI

PERMITS REQUIRED:		
<input type="checkbox"/> CITY OF ANN ARBOR	<input checked="" type="checkbox"/> CITY OF YPSILANTI	<input type="checkbox"/> EGLE
<input checked="" type="checkbox"/> WASHTENAW COUNTY	<input checked="" type="checkbox"/> YPSILANTI TOWNSHIP	<input type="checkbox"/> RR
<input checked="" type="checkbox"/> WASHTENAW COUNTY DRAIN	<input checked="" type="checkbox"/> PITTSFIELD TOWNSHIP	<input checked="" type="checkbox"/> MDOT

SHEET INFORMATION	
TOTAL SHEETS	SHEET NO.
35	28

REVISION		
REV #	DATE	DESCRIPTION
01	07/13/23	REV BORE PATH SHTS 10-13 FOR CLEARANCE FROM DRAIN
02	08/01/23	ADD DEPTH NOTE SHT 12
03	09/06/23	REVISED PER WCRC.WCWR & PITTSFIELD TWP COMMENTS
04	10/10/23	REVISED PER WCRC COMMENTS

CITY OF YPSILANTI
SEC:08 T:03S R:07E

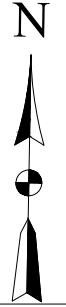
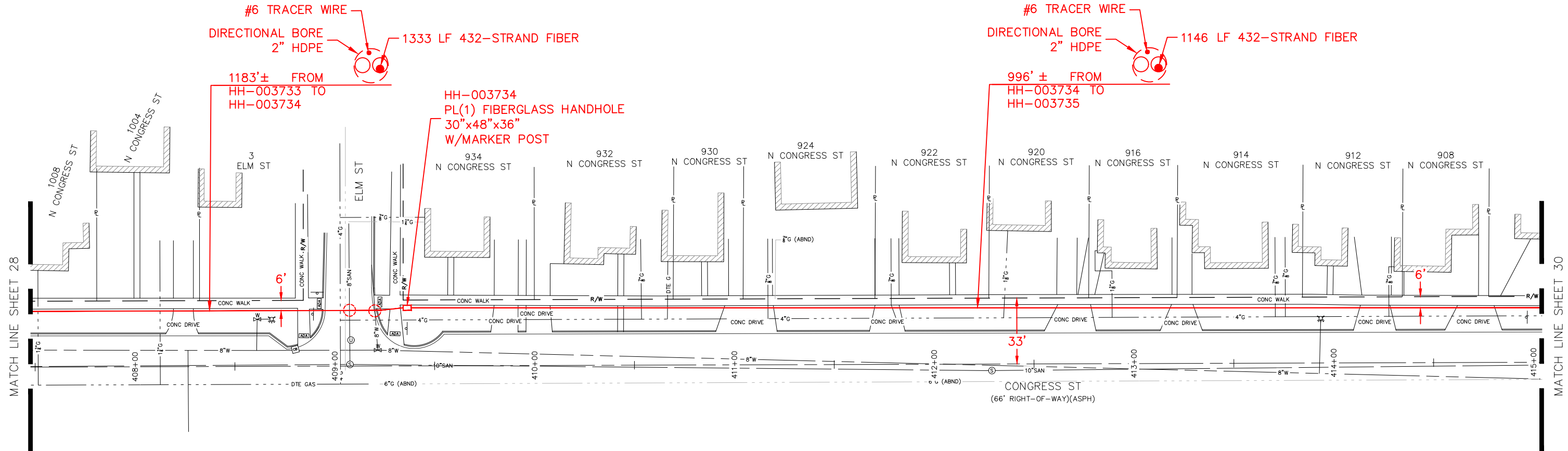

K:\2022\1043 JOB FOLDERS\1043-22-0323\DWG\1043-22-0323_DS.dwg; 6/6/2023 2:21 PM;



THE LOCATIONS OF EXISTING UNDERGROUND UTILITIES ARE SHOWN IN AN APPROXIMATE WAY ONLY AND HAVE NOT BEEN INDEPENDENTLY VERIFIED. THE CONTRACTOR SHALL DETERMINE THE EXACT LOCATION OF ALL EXISTING UTILITIES BEFORE COMMENCING WORK, AND AGREES TO BE FULLY RESPONSIBLE FOR ANY AND ALL DAMAGES WHICH MIGHT BE OCCASIONED BY THE CONTRACTOR'S FAILURE TO EXACTLY LOCATE AND PRESERVE ANY AND ALL UNDERGROUND UTILITIES.

METRO ENGINEERING SOLUTIONS
33900 SCHOOLCRAFT RD
LIVONIA, MICHIGAN 48150
PHONE: 734.483.1427 FAX: 734.483.3431
www.metroes.net

SOUTH ROUTE - EAST OF U.S. 23	
MES JOB# 1043-22	DRAWN — KMM
PLOT SCALE = 1" = 50'	CHECKED — JB
PLAN DATE = 6/6/2023	

ANN ARBOR SPARK
CORRIDOR FIBER OPTIC BACKBONE PROJECT
ANN ARBOR
WASHTENAW COUNTY, MI

PERMITS REQUIRED:		
<input type="checkbox"/> CITY OF ANN ARBOR	<input checked="" type="checkbox"/> CITY OF YPSILANTI	<input type="checkbox"/> EGLE
<input checked="" type="checkbox"/> WASHTENAW COUNTY	<input checked="" type="checkbox"/> YPSILANTI TOWNSHIP	<input type="checkbox"/> RR
<input checked="" type="checkbox"/> WASHTENAW COUNTY DRAIN	<input checked="" type="checkbox"/> PITTSFIELD TOWNSHIP	<input checked="" type="checkbox"/> MDOT

SHEET INFORMATION	
TOTAL SHEETS	SHEET NO.
35	29

REVISION		
REV #	DATE	DESCRIPTION
01	07/13/23	REV BORE PATH SHTS 10-13 FOR CLEARANCE FROM DRAIN
02	08/01/23	ADD DEPTH NOTE SHT 12
03	09/06/23	REVISED PER WCRC.WCWRC & PITTSFIELD TWP COMMENTS
04	10/10/23	REVISED PER WCRC COMMENTS

CITY OF YPSILANTI
SEC:08 T:03S R:07E

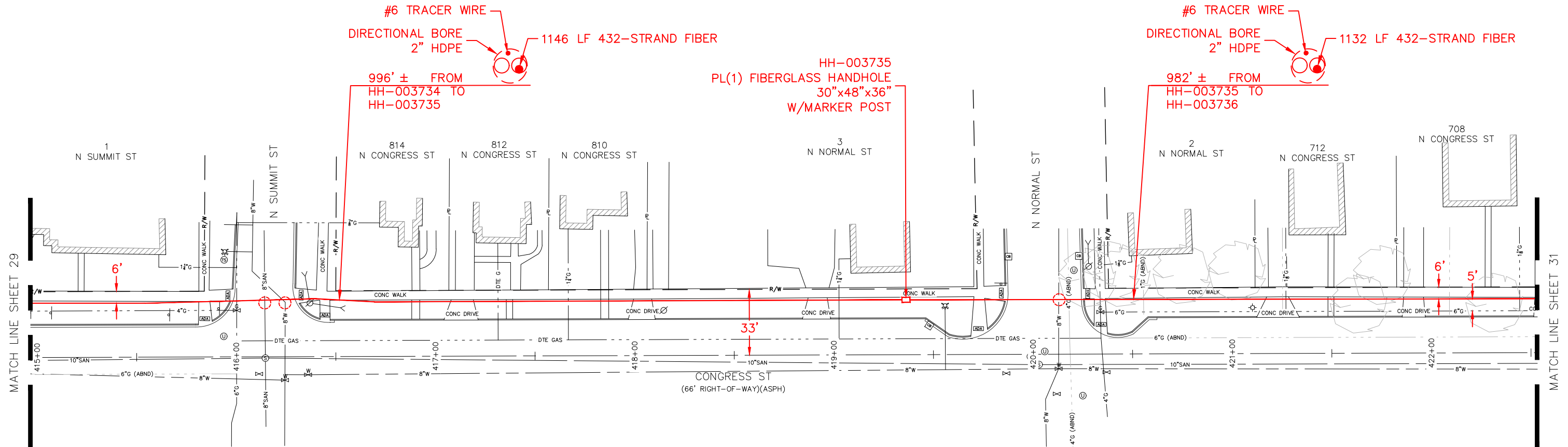

#6 TRACER WIRE
DIRECTIONAL BORE
2" HDPE
1146 LF 432-STRAND FIBER
996' ± FROM
HH-003734 TO
HH-003735

HH-003735
PL(1) FIBERGLASS HANDHOLE
30"x48"x36"
W/MARKER POST

#6 TRACER WIRE
DIRECTIONAL BORE
2" HDPE
1132 LF 432-STRAND FIBER
982' ± FROM
HH-003735 TO
HH-003736

K:\2022\1043 JOB FOLDERS\1043-22-0323\DWG\1043-22-0323_DS.dwg; 6/6/2023 2:21 PM;



Know what's below.
Call before you dig.

THE LOCATIONS OF EXISTING UNDERGROUND UTILITIES ARE SHOWN IN AN APPROXIMATE WAY ONLY AND HAVE NOT BEEN INDEPENDENTLY VERIFIED. THE CONTRACTOR SHALL DETERMINE THE EXACT LOCATION OF ALL EXISTING UTILITIES BEFORE COMMENCING WORK, AND AGREES TO BE FULLY RESPONSIBLE FOR ANY AND ALL DAMAGES WHICH MIGHT BE OCCASIONED BY THE CONTRACTOR'S FAILURE TO EXACTLY LOCATE AND PRESERVE ANY AND ALL UNDERGROUND UTILITIES.

METRO ENGINEERING SOLUTIONS
33900 SCHOOLCRAFT RD
LIVONIA, MICHIGAN 48150
PHONE: 734.483.1427 FAX: 734.483.3431
www.metroes.net

SOUTH ROUTE - EAST OF U.S. 23	
MES JOB# 1043-22	DRAWN — KMM
PLOT SCALE = 1" = 50'	CHECKED - JB
PLAN DATE = 6/6/2023	

ANN ARBOR SPARK
CORRIDOR FIBER OPTIC BACKBONE PROJECT
ANN ARBOR
WASHTENAW COUNTY, MI

PERMITS REQUIRED:		
<input type="checkbox"/> CITY OF ANN ARBOR	<input checked="" type="checkbox"/> CITY OF YPSILANTI	<input type="checkbox"/> EGLE
<input checked="" type="checkbox"/> WASHTENAW COUNTY	<input checked="" type="checkbox"/> YPSILANTI TOWNSHIP	<input type="checkbox"/> RR
<input checked="" type="checkbox"/> WASHTENAW COUNTY DRAIN	<input checked="" type="checkbox"/> PITTSFIELD TOWNSHIP	<input checked="" type="checkbox"/> MDOT

SHEET INFORMATION	
TOTAL SHEETS	SHEET NO.
35	30

REVISION		
REV #	DATE	DESCRIPTION
01	07/13/23	REV BORE PATH SHTS 10-13 FOR CLEARANCE FROM DRAIN
02	08/01/23	ADD DEPTH NOTE SHT 12
03	09/06/23	REVISED PER WCRC.WCWRC & PITTSFIELD TWP COMMENTS
04	10/10/23	REVISED PER WCRC COMMENTS

CITY OF YPSILANTI
SEC:09 T:03S R:07E

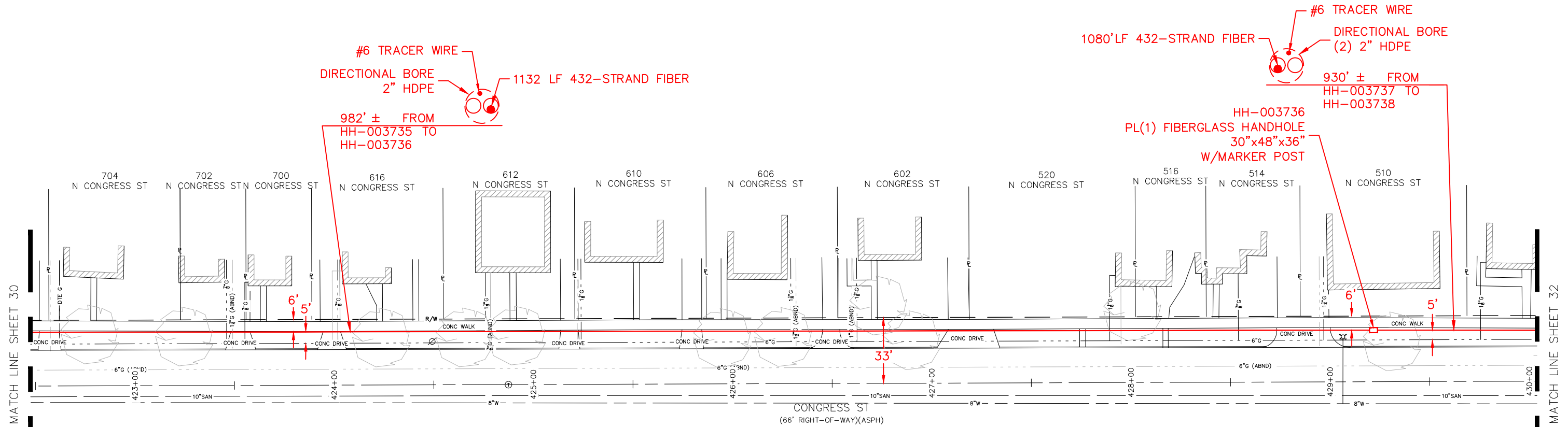

K:\2022\1043 JOB FOLDERS\1043-22-0323\DWG\1043-22-0323_DS.dwg; 6/6/2023 2:21 PM;



Know what's below.
Call before you dig.

THE LOCATIONS OF EXISTING UNDERGROUND UTILITIES ARE SHOWN IN AN APPROXIMATE WAY ONLY AND HAVE NOT BEEN INDEPENDENTLY VERIFIED. THE CONTRACTOR SHALL DETERMINE THE EXACT LOCATION OF ALL EXISTING UTILITIES BEFORE COMMENCING WORK, AND AGREES TO BE FULLY RESPONSIBLE FOR ANY AND ALL DAMAGES WHICH MIGHT BE OCCASIONED BY THE CONTRACTOR'S FAILURE TO EXACTLY LOCATE AND PRESERVE ANY AND ALL UNDERGROUND UTILITIES.

METRO ENGINEERING SOLUTIONS
33900 SCHOOLCRAFT RD
LIVONIA, MICHIGAN 48150
PHONE: 734.483.1427 FAX: 734.483.3431
www.metroes.net

SOUTH ROUTE - EAST OF U.S. 23	
MES JOB# 1043-22	DRAWN — KMM
PLOT SCALE = 1" = 50'	CHECKED — JB
PLAN DATE = 6/6/2023	

ANN ARBOR SPARK
CORRIDOR FIBER OPTIC BACKBONE PROJECT
ANN ARBOR
WASHTENAW COUNTY, MI

PERMITS REQUIRED:		
<input type="checkbox"/> CITY OF ANN ARBOR	<input checked="" type="checkbox"/> CITY OF YPSILANTI	<input type="checkbox"/> EGLE
<input checked="" type="checkbox"/> WASHTENAW COUNTY	<input checked="" type="checkbox"/> YPSILANTI TOWNSHIP	<input type="checkbox"/> RR
<input checked="" type="checkbox"/> WASHTENAW COUNTY DRAIN	<input checked="" type="checkbox"/> PITTSFIELD TOWNSHIP	<input checked="" type="checkbox"/> MDOT

SHEET INFORMATION	
TOTAL SHEETS	SHEET NO.
35	31

REVISION		
REV #	DATE	DESCRIPTION
01	07/13/23	REV BORE PATH SHTS 10-13 FOR CLEARANCE FROM DRAIN
02	08/01/23	ADD DEPTH NOTE SHT 12
03	09/06/23	REVISED PER WCRC.WCWR & PITTSFIELD TWP COMMENTS
04	10/10/23	REVISED PER WCRC COMMENTS



CITY OF YPSILANTI
SEC:09 T:03S R:07E

#6 TRACER WIRE
DIRECTIONAL BORE
2" HDPE

930' ± FROM
HH-003736 TO
HH-003737

1080 LF 432-STRAND FIBER

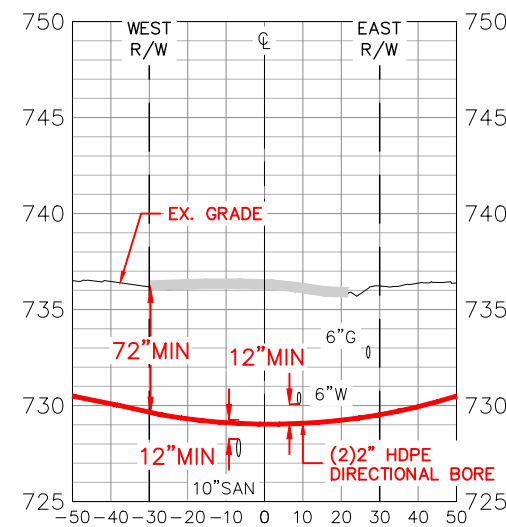
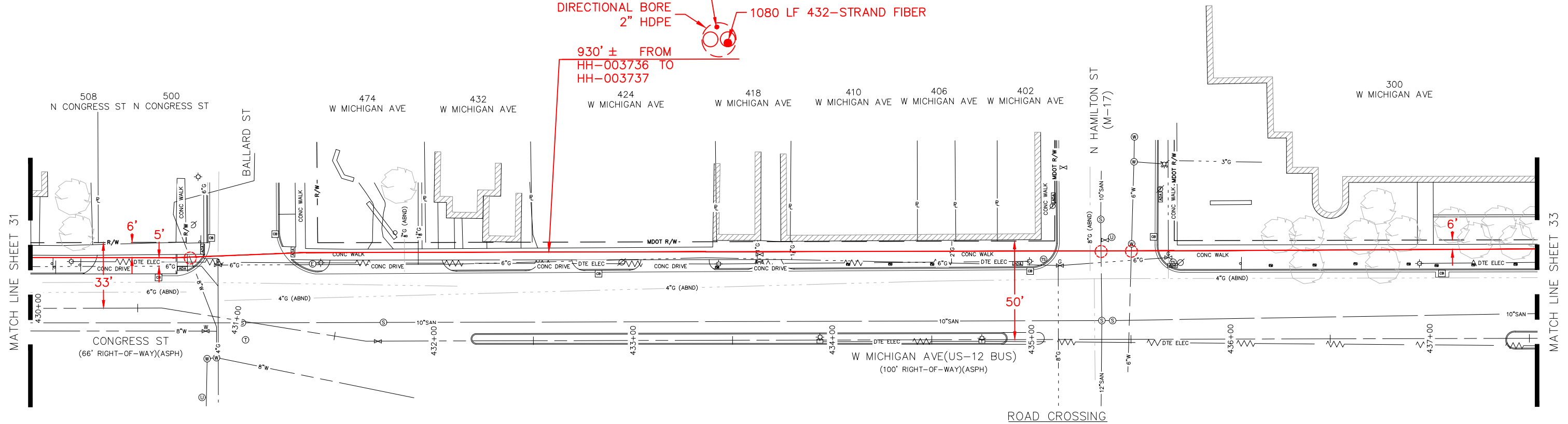

N HAMILTON ST(M-17)
LOOKING NORTH
1"=50' HORIZONTAL
1"=10' VERTICAL

REVISION		
REV #	DATE	DESCRIPTION
01	07/13/23	REV BORE PATH SHTS 10-13 FOR CLEARANCE FROM DRAIN
02	08/01/23	ADD DEPTH NOTE SHT 12
03	09/06/23	REVISED PER WCRC.WCWRC & PITTSFIELD TWP COMMENTS
04	10/10/23	REVISED PER WCRC COMMENTS



THE LOCATIONS OF EXISTING UNDERGROUND UTILITIES ARE SHOWN IN AN APPROXIMATE WAY ONLY AND HAVE NOT BEEN INDEPENDENTLY VERIFIED. THE CONTRACTOR SHALL DETERMINE THE EXACT LOCATION OF ALL EXISTING UTILITIES BEFORE COMMENCING WORK, AND AGREES TO BE FULLY RESPONSIBLE FOR ANY AND ALL DAMAGES WHICH MIGHT BE OCCASIONED BY THE CONTRACTOR'S FAILURE TO EXACTLY LOCATE AND PRESERVE ANY AND ALL UNDERGROUND UTILITIES.

METRO ENGINEERING SOLUTIONS
33900 SCHOOLCRAFT RD
LIVONIA, MICHIGAN 48150
PHONE: 734.483.1427 FAX: 734.483.3431
www.metroes.net

SOUTH ROUTE - EAST OF U.S. 23	
MES JOB#	1043-22
DRAWN	KMM
PLOT SCALE	1" = 50'
CHECKED	JB
PLAN DATE	6/6/2023

ANN ARBOR SPARK
CORRIDOR FIBER OPTIC BACKBONE PROJECT
ANN ARBOR
WASHTENAW COUNTY, MI

PERMITS REQUIRED:		
<input type="checkbox"/>	CITY OF ANN ARBOR	<input checked="" type="checkbox"/>
<input checked="" type="checkbox"/>	WASHTENAW COUNTY	<input checked="" type="checkbox"/>
<input checked="" type="checkbox"/>	WASHTENAW COUNTY DRAIN	<input checked="" type="checkbox"/>
<input checked="" type="checkbox"/>	CITY OF YPSILANTI	<input type="checkbox"/>
<input checked="" type="checkbox"/>	YPSILANTI TOWNSHIP	<input type="checkbox"/>
<input checked="" type="checkbox"/>	PITTSFIELD TOWNSHIP	<input checked="" type="checkbox"/>
	EGLE	<input type="checkbox"/>
	RR	<input type="checkbox"/>
	MDOT	<input checked="" type="checkbox"/>

SHEET INFORMATION	
TOTAL SHEETS	35
SHEET NO.	32

K:\2022\1043 JOB FOLDERS\1043-22-0323\DWG\1043-22-0323_DS.dwg; 6/6/2023 2:21 PM;

CITY OF YPSILANTI
SEC:09 T:03S R:07E

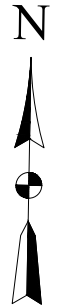
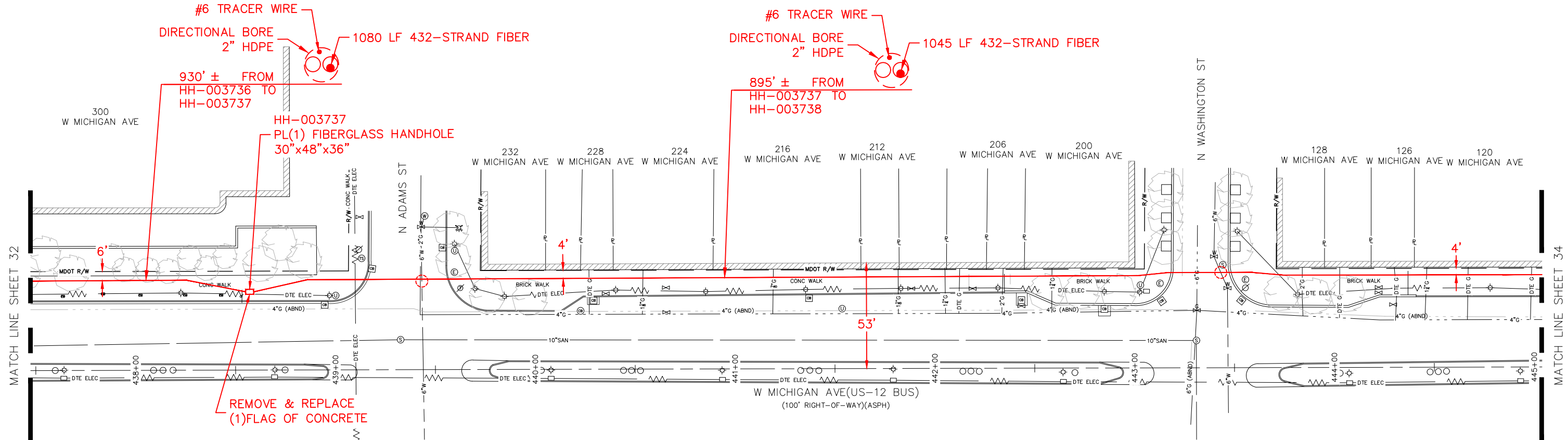

REVISION		
REV #	DATE	DESCRIPTION
01	07/13/23	REV BORE PATH SHTS 10-13 FOR CLEARANCE FROM DRAIN
02	08/01/23	ADD DEPTH NOTE SHT 12
03	09/06/23	REVISED PER WCRC.WCWR & PITTSFIELD TWP COMMENTS
04	10/10/23	REVISED PER WCRC COMMENTS



THE LOCATIONS OF EXISTING UNDERGROUND UTILITIES ARE SHOWN IN AN APPROXIMATE WAY ONLY AND HAVE NOT BEEN INDEPENDENTLY VERIFIED. THE CONTRACTOR SHALL DETERMINE THE EXACT LOCATION OF ALL EXISTING UTILITIES BEFORE COMMENCING WORK, AND AGREES TO BE FULLY RESPONSIBLE FOR ANY AND ALL DAMAGES WHICH MIGHT BE OCCASIONED BY THE CONTRACTOR'S FAILURE TO EXACTLY LOCATE AND PRESERVE ANY AND ALL UNDERGROUND UTILITIES.

METRO ENGINEERING SOLUTIONS
33900 SCHOOLCRAFT RD
LIVONIA, MICHIGAN 48150
PHONE: 734.483.1427 FAX: 734.483.3431
www.metroes.net

SOUTH ROUTE - EAST OF U.S. 23	
MES JOB# 1043-22	DRAWN — KMM
PLOT SCALE = 1" = 50'	CHECKED - JB
PLAN DATE = 6/6/2023	

ANN ARBOR SPARK
CORRIDOR FIBER OPTIC BACKBONE PROJECT
ANN ARBOR
WASHTENAW COUNTY, MI

PERMITS REQUIRED:		
<input type="checkbox"/> CITY OF ANN ARBOR	<input checked="" type="checkbox"/> CITY OF YPSILANTI	<input type="checkbox"/> EGLE
<input checked="" type="checkbox"/> WASHTENAW COUNTY	<input checked="" type="checkbox"/> YPSILANTI TOWNSHIP	<input type="checkbox"/> RR
<input checked="" type="checkbox"/> WASHTENAW COUNTY DRAIN	<input checked="" type="checkbox"/> PITTSFIELD TOWNSHIP	<input checked="" type="checkbox"/> MDOT

SHEET INFORMATION	
TOTAL SHEETS	SHEET NO.
35	33

K:\2022\1043 JOB FOLDERS\1043-22-0323\DWG\1043-22-0323_DS.dwg; 6/6/2023 2:21 PM;

MATCH LINE SHEET 35

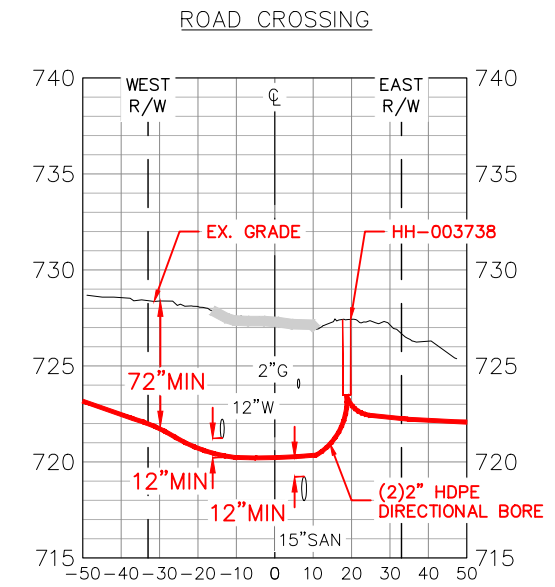
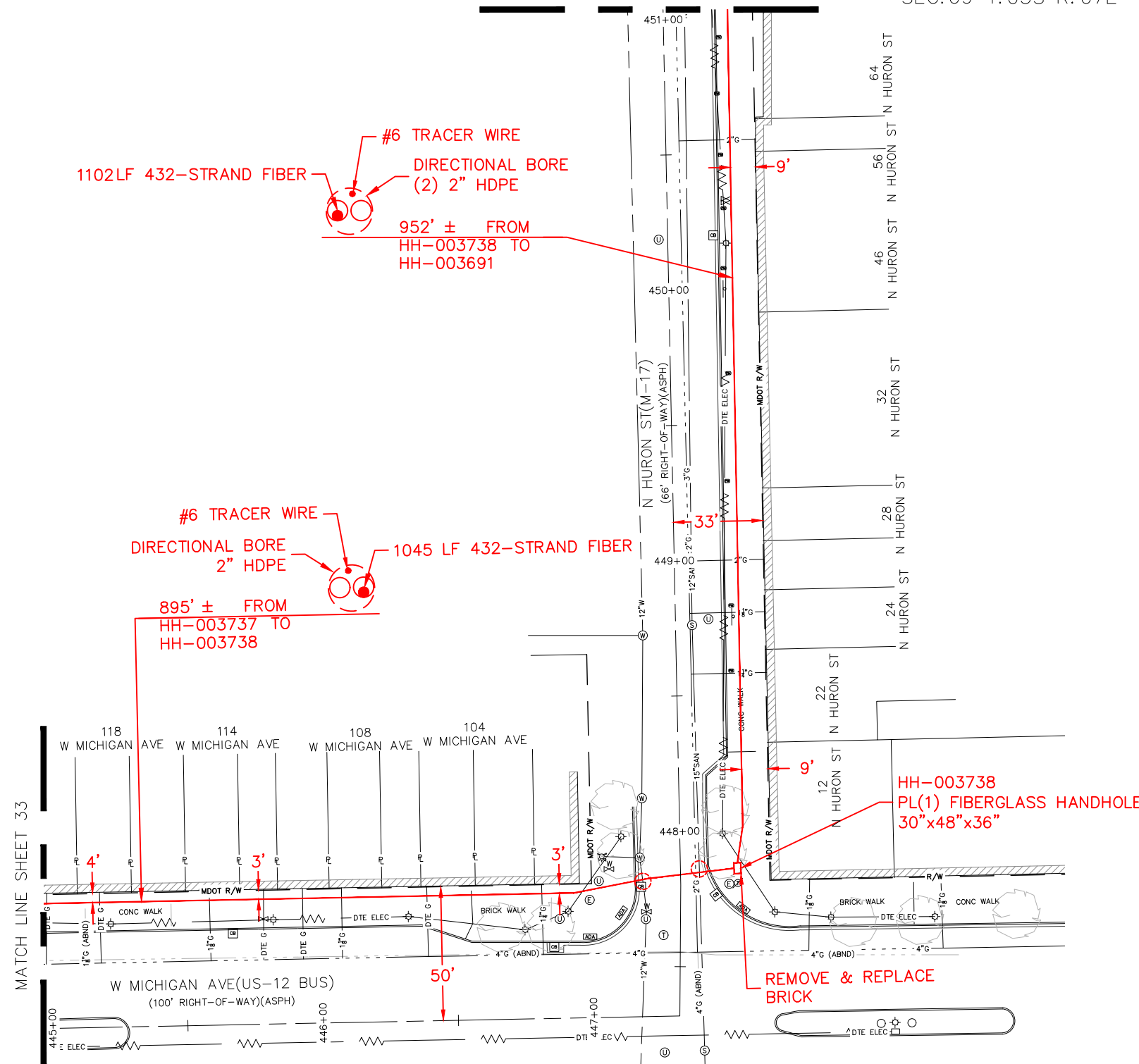

N HURON ST(M-17)
LOOKING NORTH
1"=50' HORIZONTAL
1"=10' VERTICAL

REV #	DATE	DESCRIPTION	REVISION
01	07/13/23	REV BORE PATH SHTS 10-13 FOR CLEARANCE FROM DRAIN	
02	08/01/23	ADD DEPTH NOTE SHT 12	
03	09/06/23	REVISED PER WCRC.WCWRC & PITTSFIELD TWP COMMENTS	
04	10/10/23	REVISED PER WCRC COMMENTS	



Know what's below.
Call before you dig.

THE LOCATIONS OF EXISTING UNDERGROUND UTILITIES ARE SHOWN IN AN APPROXIMATE WAY ONLY AND HAVE NOT BEEN INDEPENDENTLY VERIFIED. THE CONTRACTOR SHALL DETERMINE THE EXACT LOCATION OF ALL EXISTING UTILITIES BEFORE COMMENCING WORK, AND AGREES TO BE FULLY RESPONSIBLE FOR ANY AND ALL DAMAGES WHICH MIGHT BE OCCASIONED BY THE CONTRACTOR'S FAILURE TO EXACTLY LOCATE AND PRESERVE ANY AND ALL UNDERGROUND UTILITIES.



33900 SCHOOLCRAFT RD
LIVONIA, MICHIGAN 48150
PHONE: 734.483.1427 FAX: 734.483.3431
www.metroes.net

SOUTH ROUTE - EAST OF U.S. 23	
MES JOB# 1043-22	DRAWN - KMM
PLOT SCALE = 1" = 50'	CHECKED - JB
PLAN DATE = 6/6/2023	

ANN ARBOR SPARK
CORRIDOR FIBER OPTIC BACKBONE PROJECT
ANN ARBOR
WASHTENAW COUNTY, MI

PERMITS REQUIRED:

<input type="checkbox"/> CITY OF ANN ARBOR	<input checked="" type="checkbox"/> CITY OF YPSILANTI	<input type="checkbox"/> EGLE
<input checked="" type="checkbox"/> WASHTENAW COUNTY	<input checked="" type="checkbox"/> YPSILANTI TOWNSHIP	<input type="checkbox"/> RR
<input checked="" type="checkbox"/> WASHTENAW COUNTY DRAIN	<input checked="" type="checkbox"/> PITTSFIELD TOWNSHIP	<input checked="" type="checkbox"/> MDOT

SHEET INFORMATION

TOTAL SHEETS	SHEET NO.
35	34

CITY OF YPSILANTI
SEC:09 T:03S R:07E

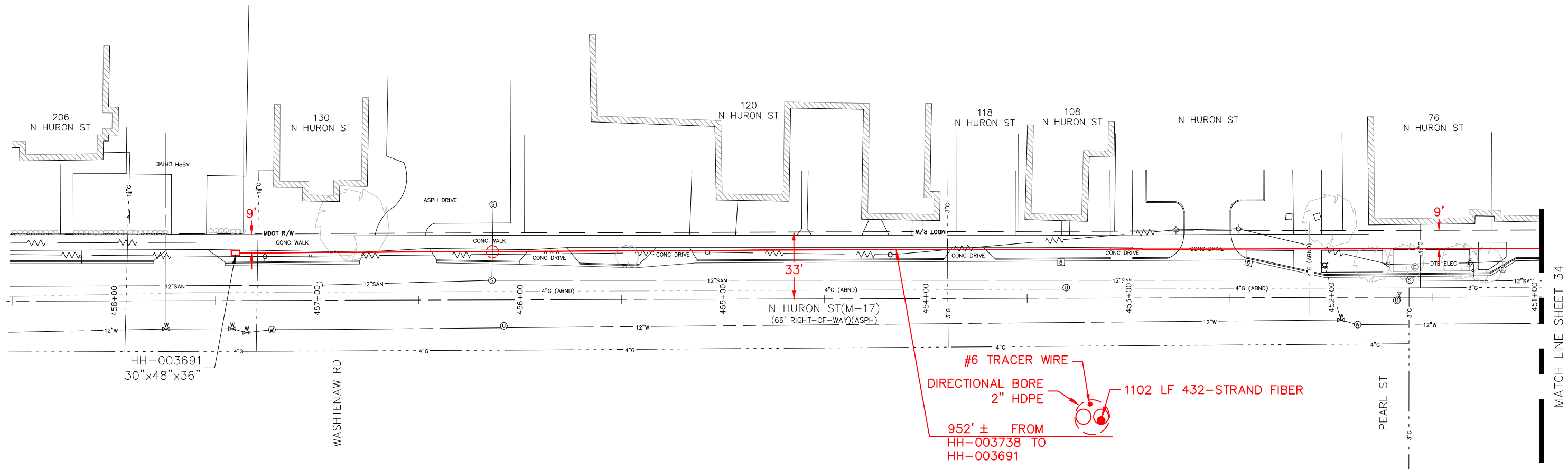

#6 TRACER WIRE
DIRECTIONAL BORE
2" HDPE
1102 LF 432-STRAND FIBER
952' ± FROM
HH-003738 TO
HH-003691

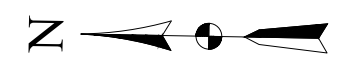

K:\2022\1043 JOB FOLDERS\1043-22-0323\DWG\1043-22-0323_DS.dwg; 6/6/2023 2:21 PM;



THE LOCATIONS OF EXISTING UNDERGROUND UTILITIES ARE SHOWN IN AN APPROXIMATE WAY ONLY AND HAVE NOT BEEN INDEPENDENTLY VERIFIED. THE CONTRACTOR SHALL DETERMINE THE EXACT LOCATION OF ALL EXISTING UTILITIES BEFORE COMMENCING WORK, AND AGREES TO BE FULLY RESPONSIBLE FOR ANY AND ALL DAMAGES WHICH MIGHT BE OCCASIONED BY THE CONTRACTOR'S FAILURE TO EXACTLY LOCATE AND PRESERVE ANY AND ALL UNDERGROUND UTILITIES.

METRO ENGINEERING SOLUTIONS
33900 SCHOOLCRAFT RD
LIVONIA, MICHIGAN 48150
PHONE: 734.483.1427 FAX: 734.483.3431
www.metroes.net

SOUTH ROUTE - EAST OF U.S. 23	
MES JOB# 1043-22	DRAWN — KMM
PLOT SCALE = 1" = 50'	CHECKED - JB
PLAN DATE = 6/6/2023	

ANN ARBOR SPARK
CORRIDOR FIBER OPTIC BACKBONE PROJECT
ANN ARBOR
WASHTENAW COUNTY, MI

PERMITS REQUIRED:		
<input type="checkbox"/> CITY OF ANN ARBOR	<input checked="" type="checkbox"/> CITY OF YPSILANTI	<input type="checkbox"/> EGLE
<input checked="" type="checkbox"/> WASHTENAW COUNTY	<input checked="" type="checkbox"/> YPSILANTI TOWNSHIP	<input type="checkbox"/> RR
<input checked="" type="checkbox"/> WASHTENAW COUNTY DRAIN	<input checked="" type="checkbox"/> PITTSFIELD TOWNSHIP	<input checked="" type="checkbox"/> MDOT

REVISION		
REV #	DATE	DESCRIPTION
01	07/13/23	REV BORE PATH SHTS 10-13 FOR CLEARANCE FROM DRAIN
02	08/01/23	ADD DEPTH NOTE SHT 12
03	09/06/23	REVISED PER WCRC.WCWRC & PITTSFIELD TWP COMMENTS
04	10/10/23	REVISED PER WCRC COMMENTS

SHEET INFORMATION	
TOTAL SHEETS	SHEET NO.
35	35

K:\2022\1043 JOB FOLDERS\CAD Resources\Titleblocks\South Route - West of US-23\South Route - West of US-23_Cover.dwg; 9/19/2023 6:30 AM;

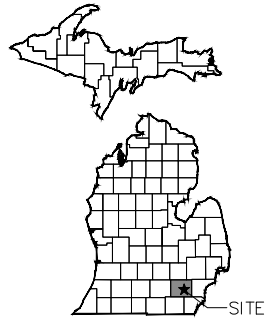

**EDA Project Number:
06-79-06299**



WASHTENAW COUNTY, MI

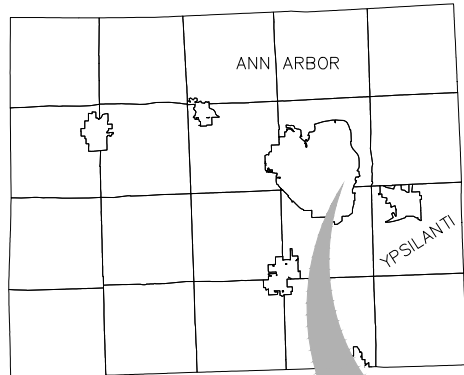

PERMITTING AGENCIES

MUNICIPALITY:

CITY OF ANN ARBOR
301 E HURON
P.O. BOX 8647
ANN ARBOR, MI 48107
(734) 794-6320

DRAIN:

WASHTENAW COUNTY
WATER RESOURCE COMMISSION
705 N ZEEB ROAD
ANN ARBOR, MI 48103

DOT:

MDOT
BRIGHTON TSC
10321 E GRAND RIVER, SUITE 500
BRIGHTON, MI 48116
(810)227-4681

SHEET INDEX

SHEET #(s)	DESCRIPTION
01	LOCATOR MAP & INDEX
02	NOTES
03	HANDHOLE & FIBER MARKER DETAIL
04	SPLICE & SLACK DETAILS
05	BLANK SHEET
06-42	PLAN SHEETS & CROSS SECTIONS

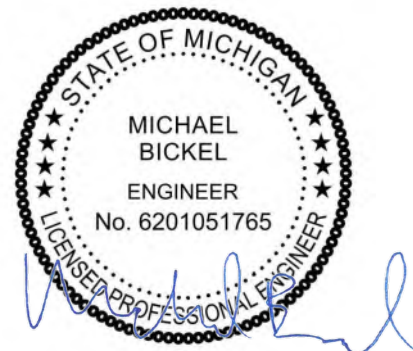

September 19, 2023

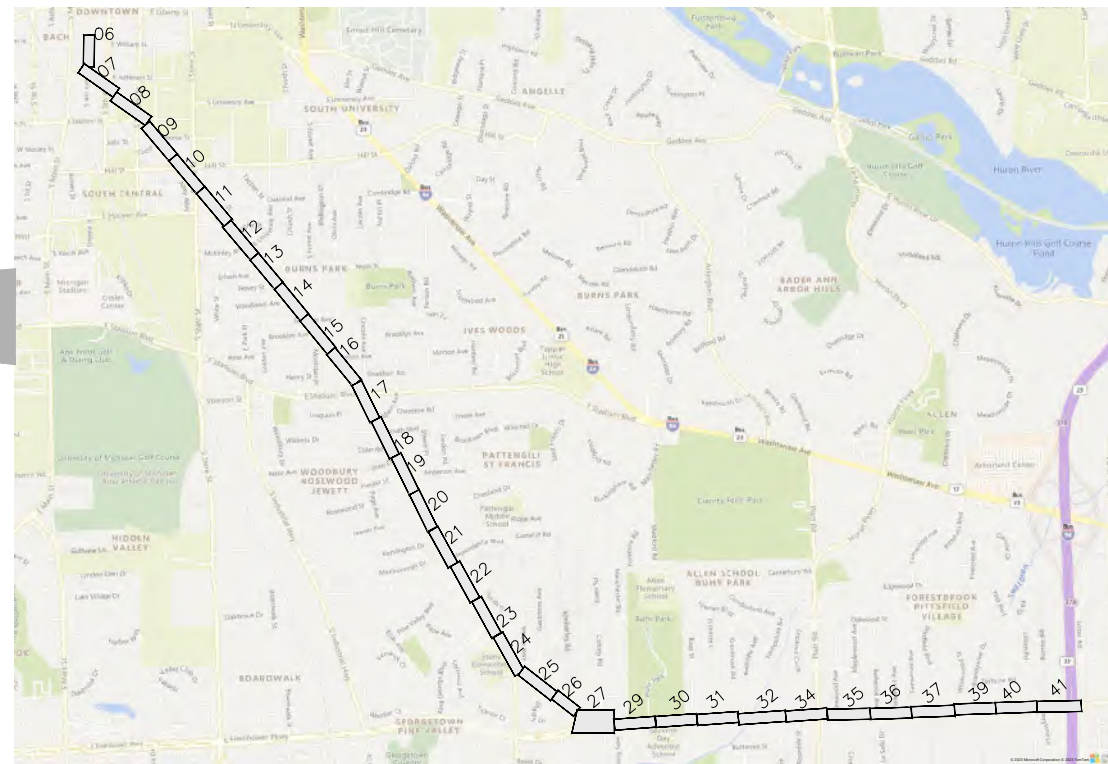

ANN ARBOR SPARK FIBER BACKBONE INFRASTRUCTURE
THIS PROJECT WILL PLACE INFRASTRUCTURE FOR THE
PLACEMENT OF FIBER OPTIC CABLE TO CONNECT THE
CITY OF ANN ARBOR WITH THE CITY OF YPSILANTI

LEGEND

— R/W —	EX. RIGHT OF WAY
---	EX. EASEMENT LINE
- - - - -	EX. Q DITCH
- - - - -	EX. GRAVEL
.....	EX. WETLAND LIMITS
=====	EX. CURB/PAVEMENT
+ + + + +	RR TRACK
○ ○ ○ ○ ○	EX. FENCE(STEEL)
□ □ □ □ □	EX. FENCE(WOOD)
○ ○ ○ ○ ○	EX. GUARDRAIL
~~~~~	EX. TREELINE
-----	EX. WATER MAIN
-----	EX. STORM SEWER
-----	EX. SANITARY SEWER
-----	EX. UND G AS
-----	EX. UND G ELECTRIC
-----	EX. UND G TELE
-----	JOINT TRENCH (POWER, TELE, CABLE)
-----	EX. UND G CABLE
-----	EX. UND G STEAM
-----	EX. OH ELECTRIC
○	EX. WATER VALVE
○	EX. HYDRANT
○	EX. WATER MANHOLE
○	EX. STORM INLET/CATCH BASIN
○	EX. ROUND STORM CATCH BASIN
○	EX. STORM MANHOLE
○	EX. STORM END SECTION
○	EX. SANITARY MANHOLE
○	EX. STEAM MANHOLE
○	EX. GAS VALVE
○	EX. GAS METER
○	EX. ELECTRIC MANHOLE
○	EX. ELECTRIC TRANS
○	EX. UTILITY POLE
○	EX. LIGHT POLE
○	EX. TRAFFIC SIGNAL POLE
○	EX. GUY WIRE
○	EX. TELE MANHOLE
○	EX. TELE PED
○	EX. UNIDENTIFIED MANHOLE
○	EX. TREE
○	EX. SIGN
---	PROP DESIGN UND G
□	PROP HANDHOLE
□	PROP SIDEWALK RESTORATION
□	PROP UTILITY CROSSING
○	PROP FIBER MARKER POST



THE LOCATIONS OF EXISTING UNDERGROUND UTILITIES ARE SHOWN IN AN APPROXIMATE WAY ONLY AND HAVE NOT BEEN INDEPENDENTLY VERIFIED. THE CONTRACTOR SHALL DETERMINE THE EXACT LOCATION OF ALL EXISTING UTILITIES BEFORE COMMENCING WORK, AND AGREES TO BE FULLY RESPONSIBLE FOR ANY AND ALL DAMAGES WHICH MIGHT BE OCCASIONED BY THE CONTRACTOR'S FAILURE TO EXACTLY LOCATE AND PRESERVE ANY AND ALL UNDERGROUND UTILITIES.

REVISION		
REV #	DATE	DESCRIPTION
01	7/14/23	REVISED PER CITY OF ANN ARBOR COMMENTS
02	8/24/23	REVISED PER CITY OF ANN ARBOR COMMENTS
03	8/28/23	REVISED PER CITY OF ANN ARBOR COMMENTS
04	9/19/23	REVISED TO AVOID WATER VALVE SHTS 21 & 24

**METRO ENGINEERING SOLUTIONS**  
33900 SCHOOLCRAFT RD  
LIVONIA, MICHIGAN 48150  
PHONE: 734.483.1427 FAX: 734.483.3431  
www.metroes.net

SOUTH ROUTE - WEST OF U.S. 23			
MES JOB#	1043-22	DRAWN	— KMM
PLOT SCALE	= 1" = 50'	CHECKED	- JB
PLAN DATE	= 5/26/2023		

ANN ARBOR SPARK	
CORRIDOR FIBER OPTIC BACKBONE PROJECT	
ANN ARBOR	
WASHTENAW COUNTY, MI	

PERMITS REQUIRED:			
<input checked="" type="checkbox"/>	CITY OF ANN ARBOR	<input type="checkbox"/>	CITY OF YPSILANTI
<input type="checkbox"/>	WASHTENAW COUNTY	<input type="checkbox"/>	YPSILANTI TOWNSHIP
<input checked="" type="checkbox"/>	WASHTENAW COUNTY DRAIN	<input type="checkbox"/>	PITTSFIELD TOWNSHIP
<input type="checkbox"/>		<input type="checkbox"/>	EGLE
<input type="checkbox"/>		<input type="checkbox"/>	RR
<input checked="" type="checkbox"/>		<input checked="" type="checkbox"/>	MDOT

SHEET INFORMATION	
TOTAL SHEETS	SHEET NO.
42	01



**GENERAL REQUIREMENTS**

- A. ALL WORK PERFORMED BY THE CONTRACTOR SHALL BE IN ACCORDANCE WITH THE CITY'S SPECIFICATIONS AND ALL APPLICABLE STANDARDS INCLUDED BUT NOT LIMITED TO THE FOLLOWING:
  - a. ANSI, ATIS, ASTM, BOCA, BICSI, EIA, IEEE, MI-OSHA, NEMA NESC, NFPA, OSHA, TIA, UL, AND ANY OTHER APPLICABLE INDUSTRY STANDARD(S).
- B. ALL TRAFFIC CONTROL NEEDED TO PERFORM ANY AND ALL PORTIONS OF THE WORK IS THE RESPONSIBILITY OF THE CONTRACTOR AND SHALL BE INCLUDED IN THE COST, REGARDLESS OF THE NUMBER OF TRAFFIC CONTROL MOBILIZATIONS AND SETUPS REQUIRED.
- C. ANY DAMAGE TO AND NOT LIMITED TO: LANDSCAPING, PRIVATE PROPERTY, UNIVERSITY OF MICHIGAN PROPERTY, ROADS, CURB AND GUTTER, SIDEWALK, OR EXISTING UTILITIES SHALL BE REPAIRED BY THE CONTRACTOR AND/OR ANY THEIR SUB-CONTRACTOR(S) IMMEDIATELY AT NO COST TO THE PROJECT.
- D. THE CONTRACTOR SHALL CONFINE WORK TO ROW PROPERTY AT ALL TIMES. AT NO TIME, SHALL THE CONTRACTOR ENTER PRIVATE PROPERTY, UNIVERSITY OF MICHIGAN PROPERTY, OR PERFORM ANY WORK NOT AUTHORIZED BY THE CITY OF ANN ARBOR.
- E. THE CONTRACTOR IS RESPONSIBLE FOR LOCATING ALL EXISTING UNDERGROUND SERVICES INCLUDING: ELECTRIC, GAS, TELEPHONE, DATA, WATER, AND SEWER PRIOR TO BEGINNING ANY UNDERGROUND WORK. COORDINATION AND COMPLIANCE WITH MISS DIG ARE REQUIRED.
- F. THE CONTRACTOR WILL PROVIDE EXPERIENCED INSTALLERS WHO ARE LICENSED OR CERTIFIED TO INSTALL CORNING FIBER MANUFACTURED MATERIAL.
- G. THE CONTRACTOR IS REQUIRED TO FACILITATE INSPECTIONS OF WORK WITH CITY OF ANN ARBOR AND THE CITY'S DESIGNATED REPRESENTATIVE (DESIGN, ENGINEERING SERVICES CONTRACTOR) THAT IS PROVIDING CONSTRUCTION OVERSITE UNDER A SEPARATE CONTRACT. ANY DEFICIENCIES REVEALED DURING INSPECTIONS BY CITY AND/OR DESIGNATED REPRESENTATIVES OF THE CITY OF ANN ARBOR, ARE THE SOLE RESPONSIBILITY OF THE CONTRACTOR TO RESOLVE.
- H. WHEN CONSTRUCTION IS COMPLETED, THE CONTRACTOR SHALL PERFORM CONTINUITY TESTING OF OPTICAL FIBERS USING OTDR AND INDUSTRY STANDARDS FOR TESTING. REFER TO SECTION "ACCEPTANCE AND TESTING" FOR REQUIREMENTS.
- I. THE CONTRACTOR SHALL INSTALL NECESSARY LIGHTING PROTECTION IN ACCORDANCE WITH AFOREMENTIONED STANDARDS.
- J. GROUNDING FOR UNDERGROUND NETWORK SEGMENTS IS REQUIRED AT EVERY SPLICE ENCLOSURE WITH A MINIMUM OF 8 (EIGHT) FEET OF GROUNDING ROD. GROUNDING RODS MUST MEET APPLICABLE INDUSTRY STANDARD SPECIFICATIONS.
- K. THE CONTRACTOR MUST ENSURE ADEQUATE CLEARANCE EXISTS BETWEEN PROPOSED FIBER BUILD AND OTHER UTILITIES, GROUND, RAIL, ROADS, AND WATER. AT A MINIMUM THE CONTRACTOR IS REQUIRED TO BUILD CONFORMING TO NESC CODES AND CITY OF ANN ARBOR STANDARD SPECIFICATIONS.
- L. THE CONTRACTOR IS ALSO RESPONSIBLE TO VERIFY LOCAL UTILITIES DO NOT HAVE MORE STRINGENT CLEARANCE CODES.
- M. THE CONTRACTOR IS RESPONSIBLE FOR ADHERING TO ALL RIGHT-OF-WAY AND UTILITY PERMITTING TERMS AND CONDITIONS AS SET FORTH IN EACH RIGHT-OF-WAY PERMIT.
- N. ANY CONSTRUCTION CHANGES MUST BE PRE-APPROVED BY THE CITY OF ANN ARBOR AND THE CITY OF ANN ARBOR'S DESIGN AND PLANNING CONTRACTOR BEFORE COMMENCING WITH SAID CHANGE. REDLINE EDITED DRAWINGS IN AUTOCAD FORMAT WILL BE REQUIRED TO DOCUMENT ANY APPROVED CHANGES.
- O. IF DEFICIENCIES AND/OR NON-COMPLIANCE ISSUES ARE DISCOVERED BY THE CITY OF ANN ARBOR PROJECT MANAGER OR THE CITY OR ANN ARBOR'S DESIGN AND PLANNING CONTRACTOR THE CONTRACTOR IS RESPONSIBLE FOR THE CORRECTION.
- P. THE CONTRACTOR IS RESPONSIBLE FOR ALL JOBSITE CLEANUP AND FOR REMOVAL OF ALL SPENT FIBER REELS AND OTHER MATERIALS USED DURING CONSTRUCTION.
- Q. CONSTRUCTION WILL BE SUBJECT TO PERIODIC INSPECTIONS BY CORNING AND THE CONSTRUCTION CONTRACTOR MUST COMPLY WITH ANY MODIFICATIONS MADE BY CORNING IN ORDER FOR THE CITY TO MAINTAIN ITS CORNING WARRANTY
- R. THE CONTRACTOR IS RESPONSIBLE FOR THE RESTORATION OF THE WORK AREA, INCLUDING LANDSCAPING, TO ITS ORIGINAL CONDITION AFTER WORK IS COMPLETE. SURROUNDING AREA MUST BE FILLED, LEVELED, AND COMPACTED. IF GRASS RESTORATION IS REQUIRED, CONTRACTOR MUST APPLY SEED OR HYDRO SEED. IF WORK CANNOT BE COMPLETED DUE TO UNSEASONAL CONDITIONS, THE WORK WILL BE COMPLETED WHEN FEASIBLE AND WITHIN THE 1-YEAR WARRANTY PERIOD. PAYMENT FOR PROJECTS WITH OUTSTANDING WORK DUE TO UNSEASONAL CONDITIONS WILL BE NEGOTIATED ON A PER PROJECT BASIS. AN ACTIVE PROJECT PUNCH LIST OF ITEMS WILL BE DOCUMENTED AND TRACKED BY THE CITY OF ANN ARBOR PROJECT MANAGER UNTIL ALL WORK HAS BEEN COMPLETED.
- S. IF POTHOLING IS REQUIRED IN SIDEWALK CONCRETE THE ENTIRE CONCRETE SLAB MUST BE RESTORED, NOT JUST THE POTHOLE AREA

**M-DOT NOTES:**

- A) DIRECTIONAL DRILLING SHALL BE CONSTRUCTED PER THE MDOT TRENCHLESS SPECIFICATION 3703A.
- B) NO PARKING OR STORAGE OF MATERIAL OR EQUIPMENT WILL BE ALLOWED WITHIN THE M-DOT RIGHT-OF-WAY.
- C) REMOVE AND REPLACE SIDEWALK AS DIRECTED BY THE FIELD INSPECTOR. UNLESS OTHERWISE SPECIFIED, ANY DAMAGED SIDEWALK SHALL BE REPLACED IN ACCORDANCE TO MDOT STANDARD DETAILS R-29 SERIES AND R-28 SERIES FOR SIDEWALK RAMPS.
- D) NO OPEN EXCAVATION SHALL REMAIN OVERNIGHT. ALL ACCESS PITS, OPEN EXCAVATION, EQUIPMENT AND SUPPLIES SHALL BE PROTECTED WITH SUITABLE FENCING AND PLASTIC DRUMS TO PROHIBIT PEDESTRIAN ACCESS TO THE WORK SITE. EQUIPMENT SHALL NOT BE USED AS FENCING TO PROTECT ACCESS PITS.
- E) A SAFE AND ADEQUATE TRAVEL ROUTE FOR PEDESTRIANS SHALL BE MAINTAINED AT ALL TIMES. PEDESTRIANS SHALL NOT BE DETOURED INTO THE ROADWAY OR DIRECTED TO CROSS THE TRUNKLINE AT NON SIGNALIZED INTERSECTIONS.
- F) ALL TRAFFIC CONTROL DEVICES INCLUDING SIGNS AND PAVEMENT MARKINGS (REMOVAL AND INSTALLATIONS) SHALL BE MAINTAINED AND/OR INSTALLED IN ACCORDANCE WITH CURRENT MDOT STANDARDS AND SPECIFICATIONS. CHARGES ARE THE SOLE RESPONSIBILITY OF THE PERMITTED.
- G) PERMITTEE AND CONTRACTORS ARE SUBJECT TO: PART 201, PUBLIC ACT 451 OF 1994, AS AMENDED. IN THE EVENT OF EXCAVATION ENCOUNTERING ENVIRONMENTAL CONTAMINATION OR AN UNDERGROUND TANK IN MDOT RIGHT-OF-WAY, WORK WITHIN THE RIGHT OF WAY SHALL CEASE UNTIL ALL ACTIONS/NOTIFICATIONS SPECIFIED BY PART 201 HAVE BEEN COMPLETED.
- H) PERMITTEE AND CONTRACTORS ARE SUBJECT TO PART 91, PUBLIC ACT 451 OF 1994, AS AMENDED. SOIL EROSION AND SEDIMENTATION CONTROL.
- I) ALL TRAFFIC CONTROL DEVICES USED ON THIS PERMIT SHALL MEET THE REQUIREMENTS OF THE "MICHIGAN MANUAL OF UNIFORM TRAFFIC CONTROL DEVICES," (MMUTCD) CURRENT EDITION, AND THE AMERICAN TRAFFIC SAFETY ASSOCIATION (ATSA) "QUALITY DEVICES ARE INCLUSIVE OF BUT NOT LIMITED TO SIGNS, BARRICADES, VERTICAL PANELS, DRUMS, WARNING LIGHTS, ARROW BOARDS, CHANGEABLE MESSAGE SIGNS, CONES, TUBULAR MARKERS, PAVEMENT TAPE, PAINT AND PAVEMENT MARKERS.
- J) ALL UTILITIES INCLUDING DRAINAGE FACILITIES SHALL BE LOCATED PRIOR TO EXCAVATION IN THE MDOT RIGHT-OF-WAY. MDOT FACILITIES ARE NOT LOCATED THROUGH THE MISS DIG SYSTEM. CONTACT THE MDOT PERMIT UNIT FOR INSTRUCTIONS.
- K) THE CONTRACTOR SHALL HAVE A MICHIGAN DEPARTMENT OF TRANSPORTATION APPROVED PLAN AND PERMIT ON-SITE AT ALL TIMES.
- L) THE CONTRACTOR SHALL SUBMIT MDOT ADVANCE NOTICE THROUGH CPS A MINIMUM OF FIVE (5) DAYS PRIOR TO START OF CONSTRUCTION.
- M) THE CONTRACTOR SHALL CONTACT THE INSPECTION AGENCY AS SHOWN ON THE PERMIT 72 HOURS PRIOR TO START OF CONSTRUCTION.
- N) THE CONTRACTOR SHALL CONTACT THE INSPECTION AGENCY AS SHOWN ON THE PERMIT AT THE COMPLETION OF CONSTRUCTION FOR A FINAL INSPECTION.
- O) THE APPLICANT/CONTRACTOR IS REQUIRED TO SUBMIT A COMPLETION NOTIFICATION VIA CPS UPON COMPLETING ALL WORK COVERED UNDER THIS PERMIT.
- P) THE MDOT RIGHT-OF-WAY SHALL BE RESTORED TO PRE-WORK CONDITIONS OR BETTER.
- Q) ALL DRILLING FLUIDS SHALL NOT ENTER THE STREETS, MANHOLES, SANITARY AND STORM SEWERS, AND OTHER DRAINAGE SYSTEMS, INCLUDING STREAMS AND RIVERS.

**GENERAL CONSTRUCTION NOTES**

- A. SODDED AREAS THAT MAY BE DISTURBED DURING INSTALLATION ARE TO BE RESTORED WITH 3" OF QUALITY TOP SOIL, SEED AND MULCH
- B. MAINTAIN A MINIMUM 18" CLEARANCE FROM ALL EXISTING PUBLIC UTILITIES
- C. PROPOSED INSTALLATION TO BE PLACED AT A MINIMUM DEPTH OF 48", UNLESS OTHERWISE NOTED ON PLANS
- D. SIDEWALK REMOVAL NECESSARY ON THIS PROJECT TO BE ACCOMPLISHED IN COMPLETE FLAGS AND REPLACED IN KIND PER JURISDICTIONAL SPECIFICATIONS
- E. HARD SURFACE REMOVAL OF STREETS AND/OR DRIVEWAYS TO BE SAW CUT FULL DEPTH AND REPLACED IN KIND PER JURISDICTIONAL SPECIFICATIONS
- F. CONTRACTOR TO FIELD VERIFY ALL EXISTING UTILITY LOCATIONS, INVERTS AND GRADES PRIOR TO STARTING CONSTRUCTION
- G. EXCAVATIONS BELOW HARD SURFACES TO BE BACKFILLED WITH MDOT CLASS II GRANULAR MATERIAL IN 8" LAYERS, WELL COMPACTED TO 98% OF ITS MAXIMUM UNIT WEIGHT AT A MOISTURE CONTENT LESS THAN SATURATION
- H. TEST HOLES TO BE CONSTRUCTED AS A 12" CYLINDRICAL HOLE. SOIL TO BE REMOVED USING A VACUUM TRUCK. HOLE TO BE BACKFILLED USING A GRANULAR MATERIAL TO THE BOTTOM OF THE EXISTING PAVEMENT. PAVEMENT TO BE REPLACED IN KIND PER MDOT SPECIFICATIONS

ENGINEER ESTIMATE OF MATERIALS	
QTY	ITEM
24626	LINEAR FT OF 2-2" HDPE SDR-11 FOR FIBER
27	30"X48"X36" FIBERGLASS HAND HOLE
28676	LINEAR FT OF 432 STRAND FIBER CABLE
24626	LINEAR FT OF #6 TRACER WIRE
1	FIBER MARKER POST

REVISION		
REV #	DATE	DESCRIPTION
01	7/14/23	REVISED PER CITY OF ANN ARBOR COMMENTS
02	8/24/23	REVISED PER CITY OF ANN ARBOR COMMENTS
03	8/28/23	REVISED PER CITY OF ANN ARBOR COMMENTS
04	9/19/23	REVISED TO AVOID WATER VALVE SHTS 21 & 24



THE LOCATIONS OF EXISTING UNDERGROUND UTILITIES ARE SHOWN IN AN APPROXIMATE WAY ONLY AND HAVE NOT BEEN INDEPENDENTLY VERIFIED. THE CONTRACTOR SHALL DETERMINE THE EXACT LOCATION OF ALL EXISTING UTILITIES BEFORE COMMENCING WORK, AND AGREES TO BE FULLY RESPONSIBLE FOR ANY AND ALL DAMAGES WHICH MIGHT BE OCCASIONED BY THE CONTRACTOR'S FAILURE TO EXACTLY LOCATE AND PRESERVE ANY AND ALL UNDERGROUND UTILITIES.

<p>33900 SCHOOLCRAFT RD LIVONIA, MICHIGAN 48150 PHONE: 734.483.1427 FAX: 734.483.3431 www.metroes.net</p>	SOUTH ROUTE - WEST OF U.S. 23		ANN ARBOR SPARK		PERMITS REQUIRED:			SHEET INFORMATION					
	MES JOB#	1043-22	DRAWN	— KMM	CORRIDOR FIBER OPTIC BACKBONE PROJECT ANN ARBOR WASHTENAW COUNTY, MI	<input checked="" type="checkbox"/>	CITY OF ANN ARBOR	<input type="checkbox"/>	CITY OF YPSILANTI	<input type="checkbox"/>	EGL	TOTAL SHEETS	SHEET NO.
	PLOT SCALE	= 1" = 50'	CHECKED	- JB		<input type="checkbox"/>	WASHTENAW COUNTY	<input type="checkbox"/>	YPSILANTI TOWNSHIP	<input type="checkbox"/>	RR		
	PLAN DATE	= 5/26/2023				<input checked="" type="checkbox"/>	WASHTENAW COUNTY DRAIN	<input type="checkbox"/>	PITTSFIELD TOWNSHIP	<input checked="" type="checkbox"/>	MDOT		
											42	02	

30"X48"X36" QUAZITE HAND HOLE & FIBER MARKER POST

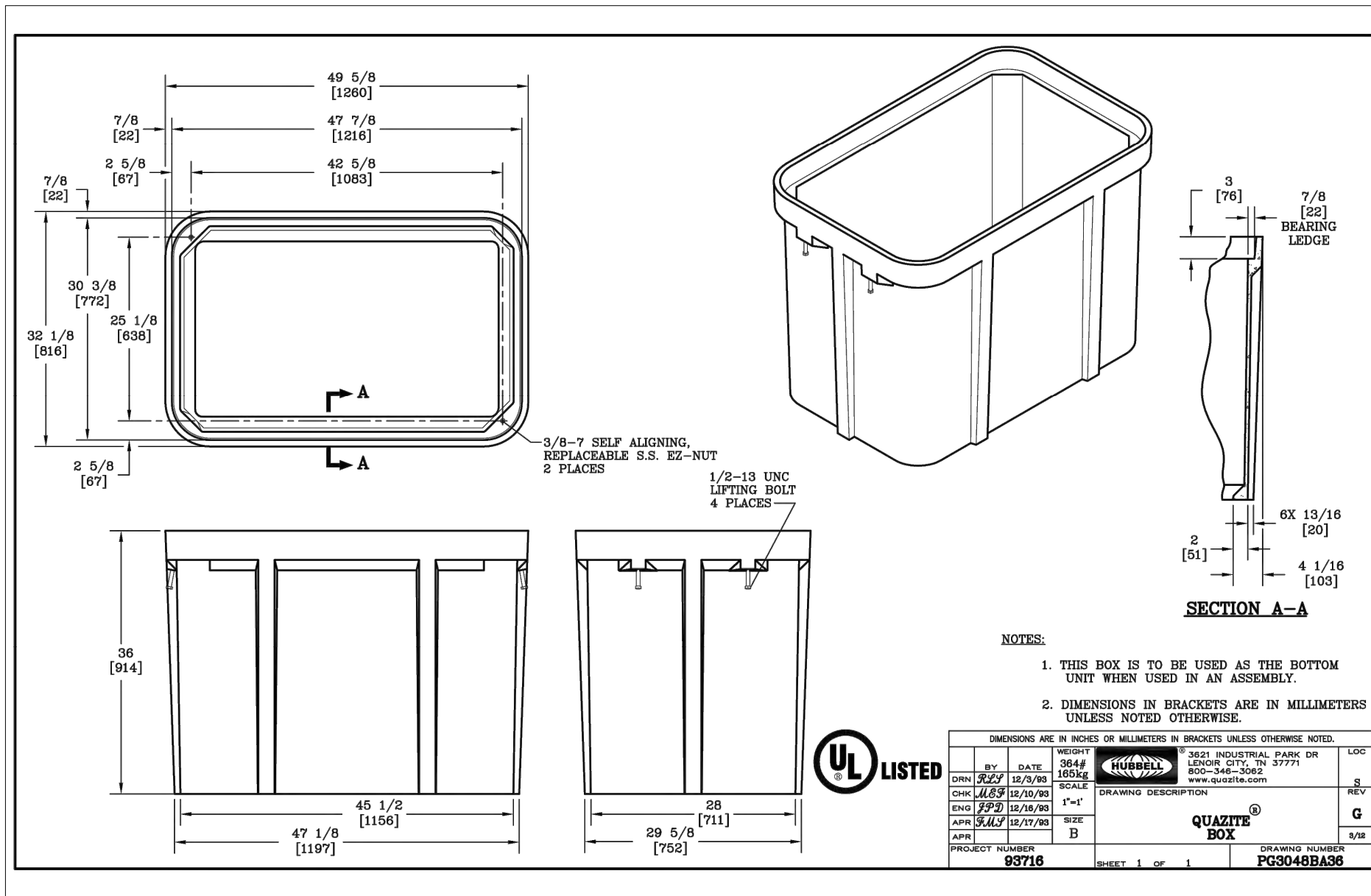

- NOTES:
1. THIS BOX IS TO BE USED AS THE BOTTOM UNIT WHEN USED IN AN ASSEMBLY.
  2. DIMENSIONS IN BRACKETS ARE IN MILLIMETERS UNLESS NOTED OTHERWISE.

DIMENSIONS ARE IN INCHES OR MILLIMETERS IN BRACKETS UNLESS OTHERWISE NOTED.		HUBBELL		3621 INDUSTRIAL PARK DR LENOIR CITY, TN 37771 800-346-3062 www.quazite.com		LOC
BY	DATE	WEIGHT	364#			S
DRN	RLP	12/3/93	165kg			REV
CHK	MSF	12/10/93	SCALE	DRAWING DESCRIPTION		G
ENG	FPD	12/16/93	1"=1'	QUAZITE [®]		3/12
APR	MSF	12/17/93	SIZE	BOX		
APR			B	PROJECT NUMBER		
				93716		DRAWING NUMBER
				SHEET 1 OF 1		PG3048BA36



THE LOCATIONS OF EXISTING UNDERGROUND UTILITIES ARE SHOWN IN AN APPROXIMATE WAY ONLY AND HAVE NOT BEEN INDEPENDENTLY VERIFIED. THE CONTRACTOR SHALL DETERMINE THE EXACT LOCATION OF ALL EXISTING UTILITIES BEFORE COMMENCING WORK, AND AGREES TO BE FULLY RESPONSIBLE FOR ANY AND ALL DAMAGES WHICH MIGHT BE OCCASIONED BY THE CONTRACTOR'S FAILURE TO EXACTLY LOCATE AND PRESERVE ANY AND ALL UNDERGROUND UTILITIES.

REVISION		
REV #	DATE	DESCRIPTION
01	7/14/23	REVISED PER CITY OF ANN ARBOR COMMENTS
02	8/24/23	REVISED PER CITY OF ANN ARBOR COMMENTS
03	8/28/23	REVISED PER CITY OF ANN ARBOR COMMENTS
04	9/19/23	REVISED TO AVOID WATER VALVE SHTS 21 & 24

**METRO ENGINEERING SOLUTIONS**  
 33900 SCHOOLCRAFT RD  
 LIVONIA, MICHIGAN 48150  
 PHONE: 734.483.1427 FAX: 734.483.3431  
 www.metroes.net

SOUTH ROUTE - WEST OF U.S. 23	
MES JOB#	1043-22
DRAWN	— KMM
PLOT SCALE	= 1" = 50'
CHECKED	- JB
PLAN DATE	= 5/26/2023

ANN ARBOR SPARK  
 CORRIDOR FIBER OPTIC BACKBONE PROJECT  
 ANN ARBOR  
 WASHTENAW COUNTY, MI

PERMITS REQUIRED:					
<input checked="" type="checkbox"/>	CITY OF ANN ARBOR	<input type="checkbox"/>	CITY OF YPSILANTI	<input type="checkbox"/>	EGLE
<input type="checkbox"/>	WASHTENAW COUNTY	<input type="checkbox"/>	YPSILANTI TOWNSHIP	<input type="checkbox"/>	RR
<input checked="" type="checkbox"/>	WASHTENAW COUNTY DRAIN	<input type="checkbox"/>	PITTSFIELD TOWNSHIP	<input checked="" type="checkbox"/>	MDOT

SHEET INFORMATION	
TOTAL SHEETS	SHEET NO.
42	03

K:\2022\1043 JOB FOLDERS\CAD Resources\Titleblocks\South Route - West of US-23\South Route - West of US-23_Cover.dwg; 9/19/2023 6:30 AM;

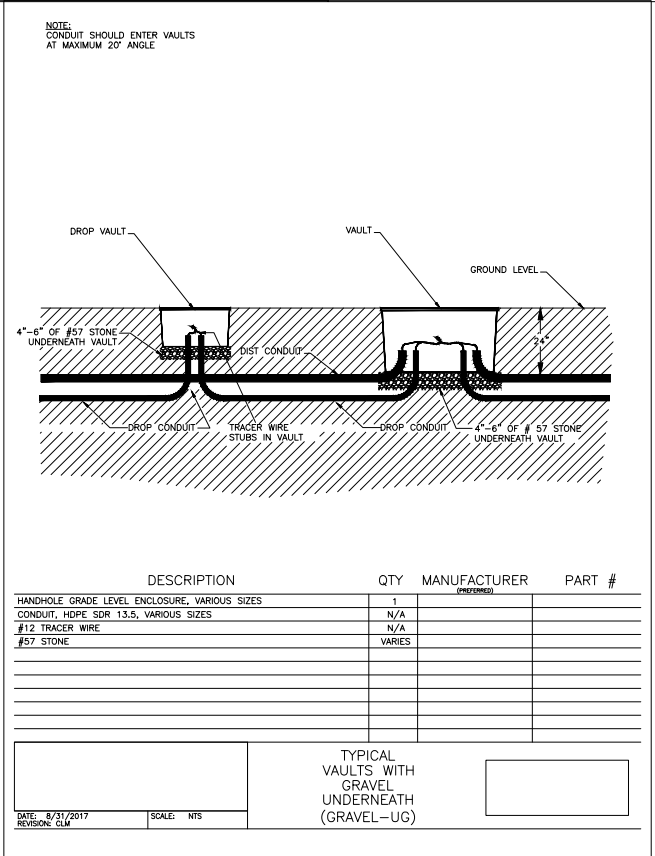
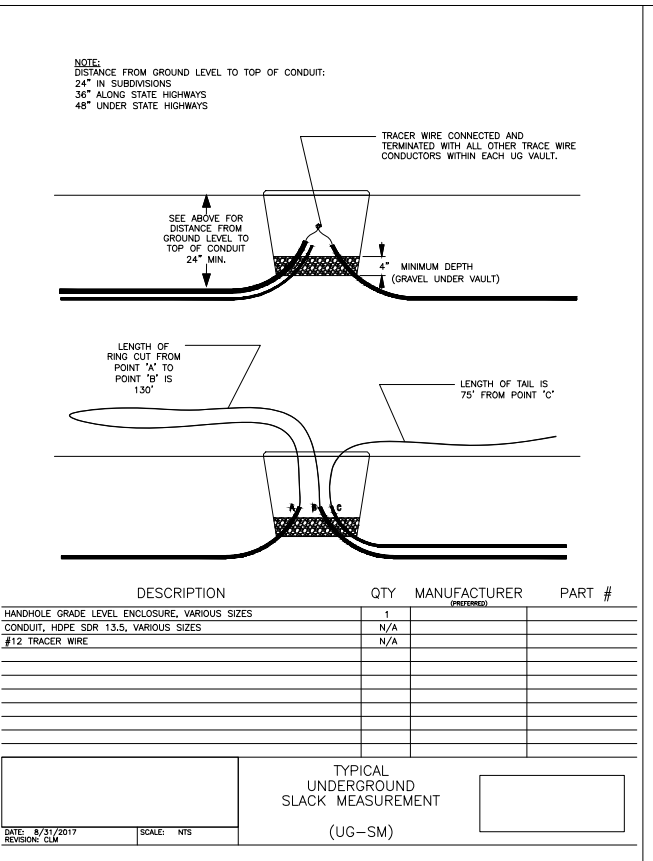
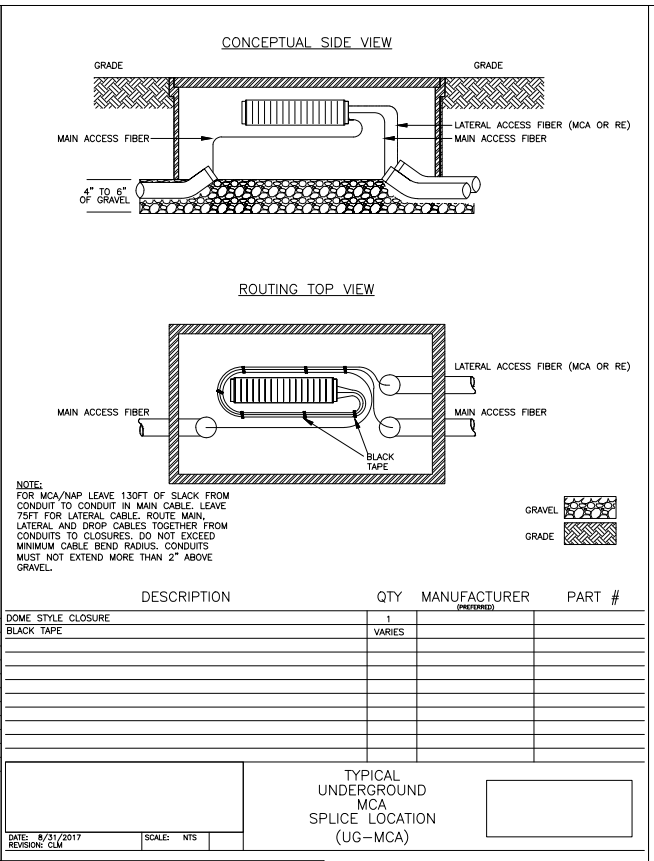
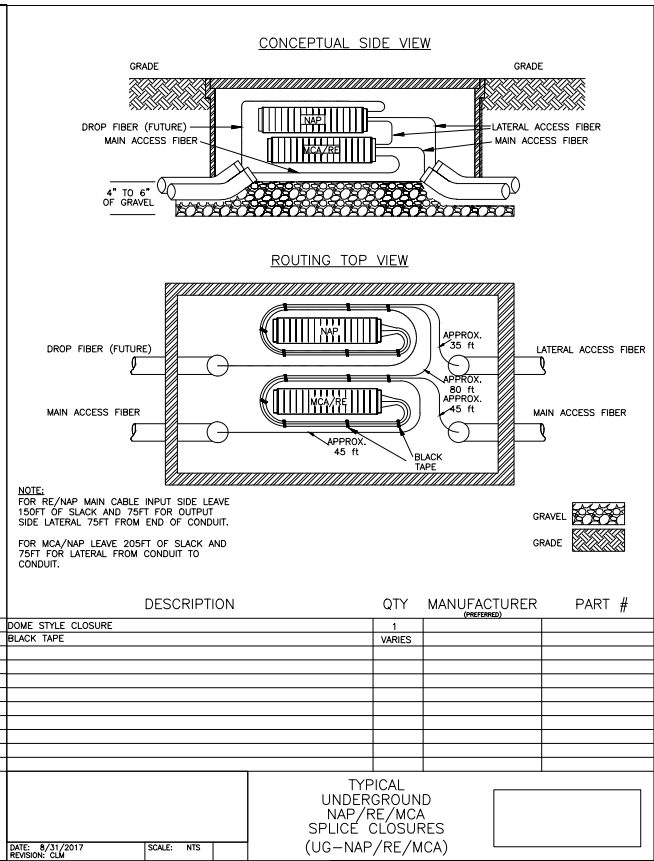
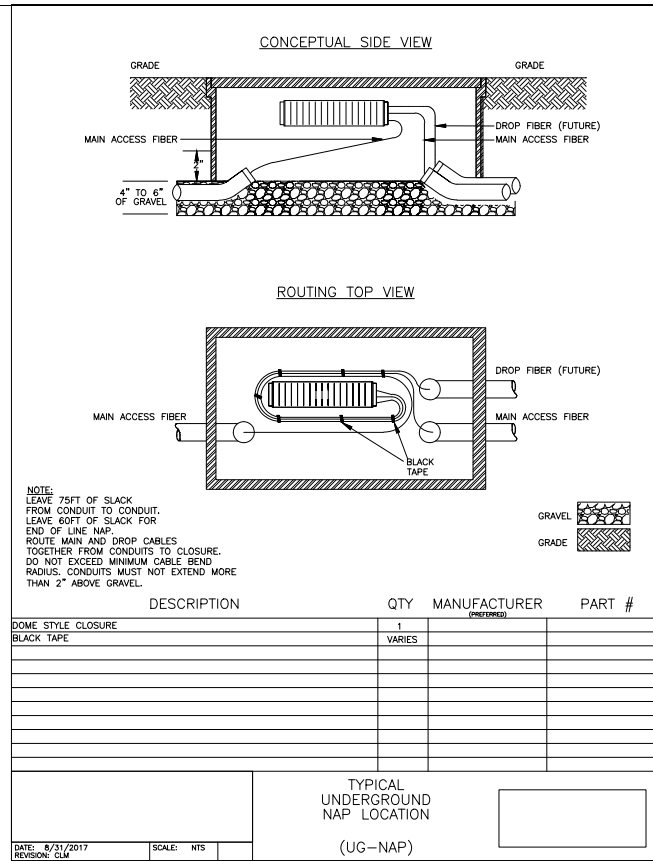

**CAUTION**  
 FIBER OPTIC CABLE

BB OF 45 CABLE ID: CABLE COUNT:

- CABLE ID TAGS ARE REQUIRED WHERE THERE ARE MULTIPLE CABLES WITHIN THE UG VAULTS
- SNAP TAGS ARE REQUIRED WHERE THERE ARE UG CABLES

REVISION		
REV #	DATE	DESCRIPTION
01	7/14/23	REVISED PER CITY OF ANN ARBOR COMMENTS
02	8/24/23	REVISED PER CITY OF ANN ARBOR COMMENTS
03	8/28/23	REVISED PER CITY OF ANN ARBOR COMMENTS
04	9/19/23	REVISED TO AVOID WATER VALVE SHTS 21 & 24



THE LOCATIONS OF EXISTING UNDERGROUND UTILITIES ARE SHOWN IN AN APPROXIMATE WAY ONLY AND HAVE NOT BEEN INDEPENDENTLY VERIFIED. THE CONTRACTOR SHALL DETERMINE THE EXACT LOCATION OF ALL EXISTING UTILITIES BEFORE COMMENCING WORK, AND AGREES TO BE FULLY RESPONSIBLE FOR ANY AND ALL DAMAGES WHICH MIGHT BE OCCASIONED BY THE CONTRACTOR'S FAILURE TO EXACTLY LOCATE AND PRESERVE ANY AND ALL UNDERGROUND UTILITIES.

**METRO ENGINEERING SOLUTIONS**  
 33900 SCHOOLCRAFT RD  
 LIVONIA, MICHIGAN 48150  
 PHONE: 734.483.1427 FAX: 734.483.3431  
 www.metroes.net

SOUTH ROUTE - WEST OF U.S. 23	
MES JOB#	1043-22
DRAWN	KMM
PLOT SCALE	1" = 50'
CHECKED	JB
PLAN DATE	5/26/2023

ANN ARBOR SPARK  
 CORRIDOR FIBER OPTIC BACKBONE PROJECT  
 ANN ARBOR  
 WASHTENAW COUNTY, MI

PERMITS REQUIRED:

<input checked="" type="checkbox"/> CITY OF ANN ARBOR	<input type="checkbox"/> CITY OF YPSILANTI	<input type="checkbox"/> EGLE
<input type="checkbox"/> WASHTENAW COUNTY	<input type="checkbox"/> YPSILANTI TOWNSHIP	<input type="checkbox"/> RR
<input checked="" type="checkbox"/> WASHTENAW COUNTY DRAIN	<input type="checkbox"/> PITTSFIELD TOWNSHIP	<input checked="" type="checkbox"/> MDOT

SHEET INFORMATION

TOTAL SHEETS	SHEET NO.
42	04

K:\2022\1043 JOB FOLDERS\CAD Resources\Titleblocks\South Route - West of US-23\South Route - West of 23_Cover.dwg; 9/19/2023 6:30 AM;

THIS SHEET  
INTENTIONALLY  
LEFT BLANK



Know what's below.  
Call before you dig.

THE LOCATIONS OF EXISTING UNDERGROUND UTILITIES ARE SHOWN IN AN APPROXIMATE WAY ONLY AND HAVE NOT BEEN INDEPENDENTLY VERIFIED. THE CONTRACTOR SHALL DETERMINE THE EXACT LOCATION OF ALL EXISTING UTILITIES BEFORE COMMENCING WORK, AND AGREES TO BE FULLY RESPONSIBLE FOR ANY AND ALL DAMAGES WHICH MIGHT BE OCCASIONED BY THE CONTRACTOR'S FAILURE TO EXACTLY LOCATE AND PRESERVE ANY AND ALL UNDERGROUND UTILITIES.

REVISION		
REV #	DATE	DESCRIPTION
01	7/14/23	REVISED PER CITY OF ANN ARBOR COMMENTS
02	8/24/23	REVISED PER CITY OF ANN ARBOR COMMENTS
03	8/28/23	REVISED PER CITY OF ANN ARBOR COMMENTS
04	9/19/23	REVISED TO AVOID WATER VALVE SHTS 21 & 24

**METRO ENGINEERING SOLUTIONS**  
33900 SCHOOLCRAFT RD  
LIVONIA, MICHIGAN 48150  
PHONE: 734.483.1427 FAX: 734.483.3431  
www.metroes.net

SOUTH ROUTE - WEST OF U.S. 23			
MES JOB#	1043-22	DRAWN	— KMM
PLOT SCALE	= 1" = 50'	CHECKED	- JB
PLAN DATE	= 5/26/2023		

ANN ARBOR SPARK  
CORRIDOR FIBER OPTIC BACKBONE PROJECT  
ANN ARBOR  
WASHTENAW COUNTY, MI

PERMITS REQUIRED:					
<input checked="" type="checkbox"/>	CITY OF ANN ARBOR	<input type="checkbox"/>	CITY OF YPSILANTI	<input type="checkbox"/>	EGLE
<input type="checkbox"/>	WASHTENAW COUNTY	<input type="checkbox"/>	YPSILANTI TOWNSHIP	<input type="checkbox"/>	RR
<input checked="" type="checkbox"/>	WASHTENAW COUNTY DRAIN	<input type="checkbox"/>	PITTSFIELD TOWNSHIP	<input checked="" type="checkbox"/>	MDOT

SHEET INFORMATION	
TOTAL SHEETS	42
SHEET NO.	05



CITY OF ANN ARBOR  
SEC: 29 T: 02S R: 06E

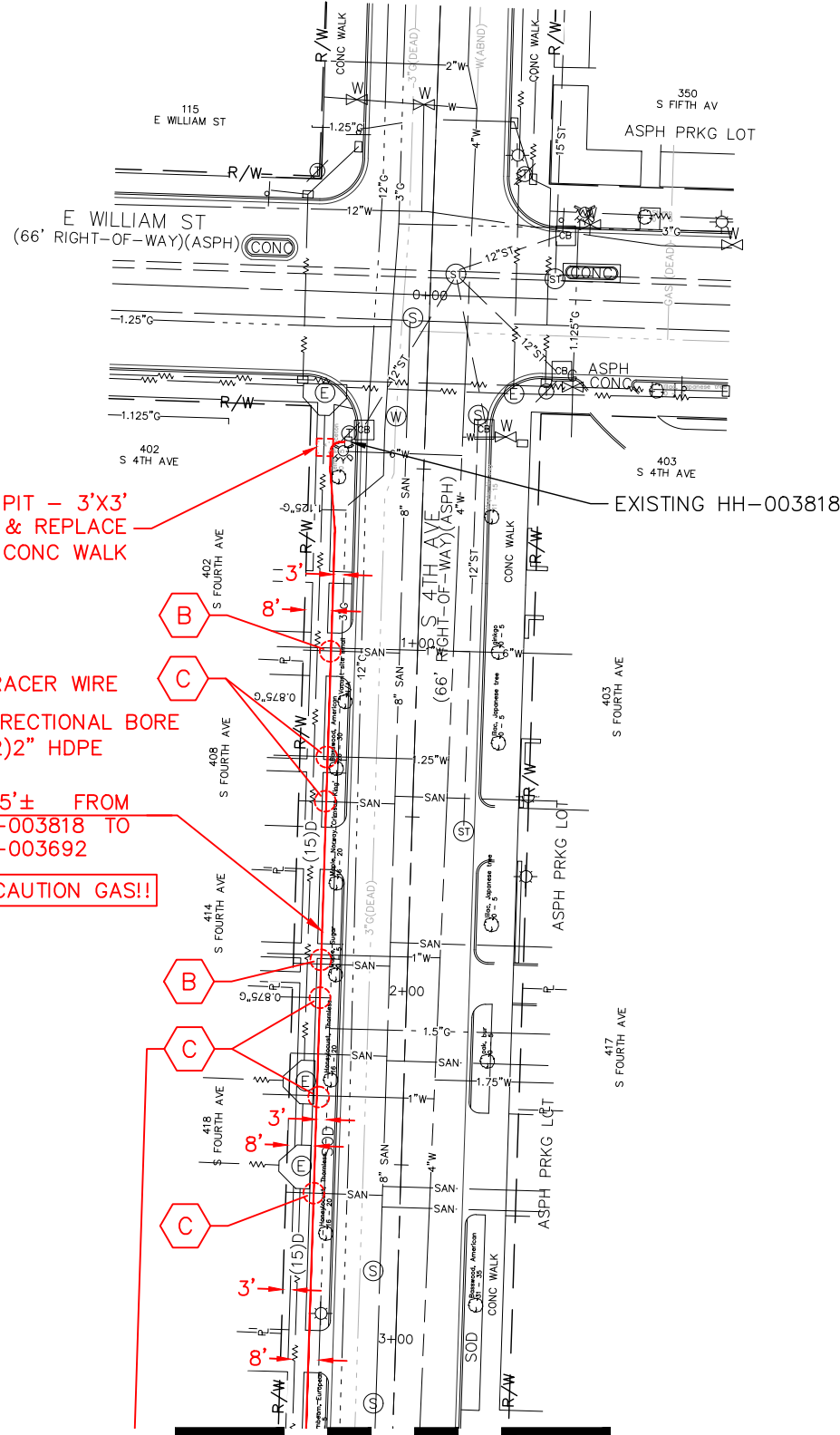

INCREASE DEPTH OF BORE TO 72" WHEN NOT UNDER SIDEWALK TO AVOID ROOT ZONE OF TREES

BORE PIT - 3'x3'  
REMOVE & REPLACE  
(1) FLAG CONC WALK

#6 TRACER WIRE

1205 LF 432-STRAND FIBER

DIRECTIONAL BORE  
(2) 2" HDPE

1055'± FROM  
HH-003818 TO  
HH-003692

CAUTION GAS!!

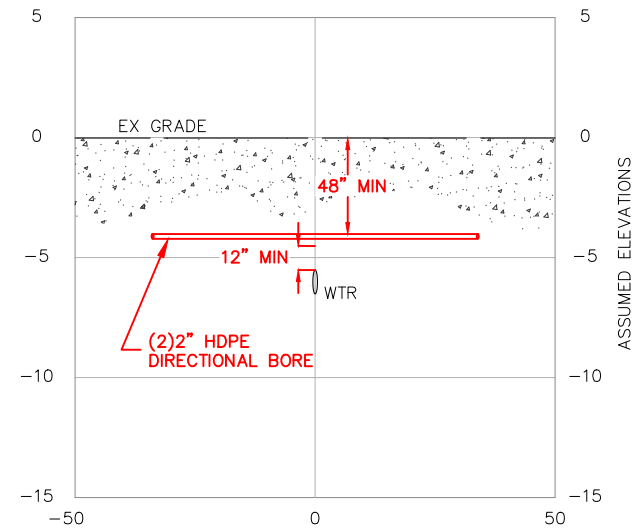

UTILITY CROSSING DETAIL  
S FOURTH ST  
STA 1+02, 1+34, 1+91, 2+31  
NOT TO SCALE

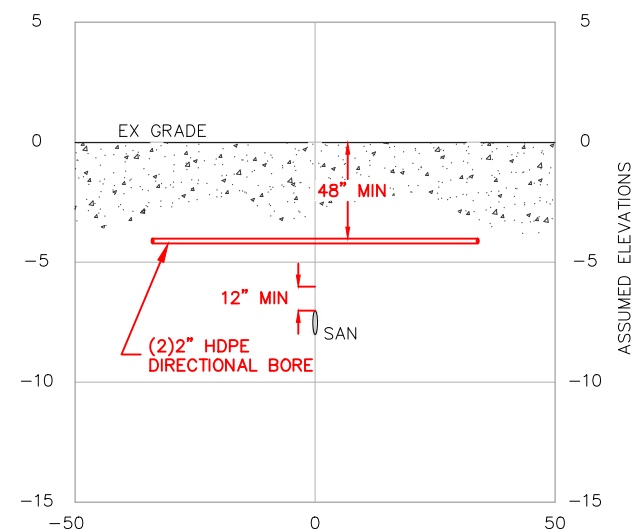

UTILITY CROSSING DETAIL  
S FOURTH AVE  
STA 1+03, 1+47, 1+94, 2+59  
NOT TO SCALE

**UTILITY CROSSING/POTHOLE NOTES**

A	POTHOLE. REMOVE & REPLACE (1) SQFT ASPH ROAD.
B	POTHOLE. REMOVE & REPLACE (1) FLAG CONC WALK.
C	POTHOLE. REMOVE & REPLACE GREENBELT.
D	NO POTHOLE NECESSARY. UTILITY DEPTH TO BE VERIFIED AT NEAREST STRUCTURE.



THE LOCATIONS OF EXISTING UNDERGROUND UTILITIES ARE SHOWN IN AN APPROXIMATE WAY ONLY AND HAVE NOT BEEN INDEPENDENTLY VERIFIED. THE CONTRACTOR SHALL DETERMINE THE EXACT LOCATION OF ALL EXISTING UTILITIES BEFORE COMMENCING WORK, AND AGREES TO BE FULLY RESPONSIBLE FOR ANY AND ALL DAMAGES WHICH MIGHT BE OCCASIONED BY THE CONTRACTOR'S FAILURE TO EXACTLY LOCATE AND PRESERVE ANY AND ALL UNDERGROUND UTILITIES.

MATCH LINE SHEET 07

REVISION		
REV #	DATE	DESCRIPTION
01	7/14/23	REVISED PER CITY OF ANN ARBOR COMMENTS
02	8/24/23	REVISED PER CITY OF ANN ARBOR COMMENTS
03	8/28/23	REVISED PER CITY OF ANN ARBOR COMMENTS
04	9/19/23	REVISED TO AVOID WATER VALVE SHTS 21 & 24

**METRO ENGINEERING SOLUTIONS**

33900 SCHOOLCRAFT RD  
LIVONIA, MICHIGAN 48150  
PHONE: 734.483.1427 FAX: 734.483.3431  
www.metroes.net

SOUTH ROUTE - WEST OF U.S. 23	
MES JOB# 1043-22	DRAWN - KMM
PLOT SCALE = 1" = 50'	CHECKED - JB
PLAN DATE = 5/26/2023	

ANN ARBOR SPARK  
CORRIDOR FIBER OPTIC BACKBONE PROJECT  
ANN ARBOR  
WASHTENAW COUNTY, MI

PERMITS REQUIRED:

<input checked="" type="checkbox"/> CITY OF ANN ARBOR	<input type="checkbox"/> CITY OF YPSILANTI	<input type="checkbox"/> EGLE
<input type="checkbox"/> WASHTENAW COUNTY	<input type="checkbox"/> YPSILANTI TOWNSHIP	<input type="checkbox"/> RR
<input checked="" type="checkbox"/> WASHTENAW COUNTY DRAIN	<input type="checkbox"/> PITTSFIELD TOWNSHIP	<input checked="" type="checkbox"/> MDOT

SHEET INFORMATION

TOTAL SHEETS	SHEET NO.
42	06

K:\2022\1043-22-0318\DWG\1043-22-0318_DS.dwg: 8/28/2023 10:26 AM;



CITY OF ANN ARBOR  
SEC: 29 T: 02S R: 06E

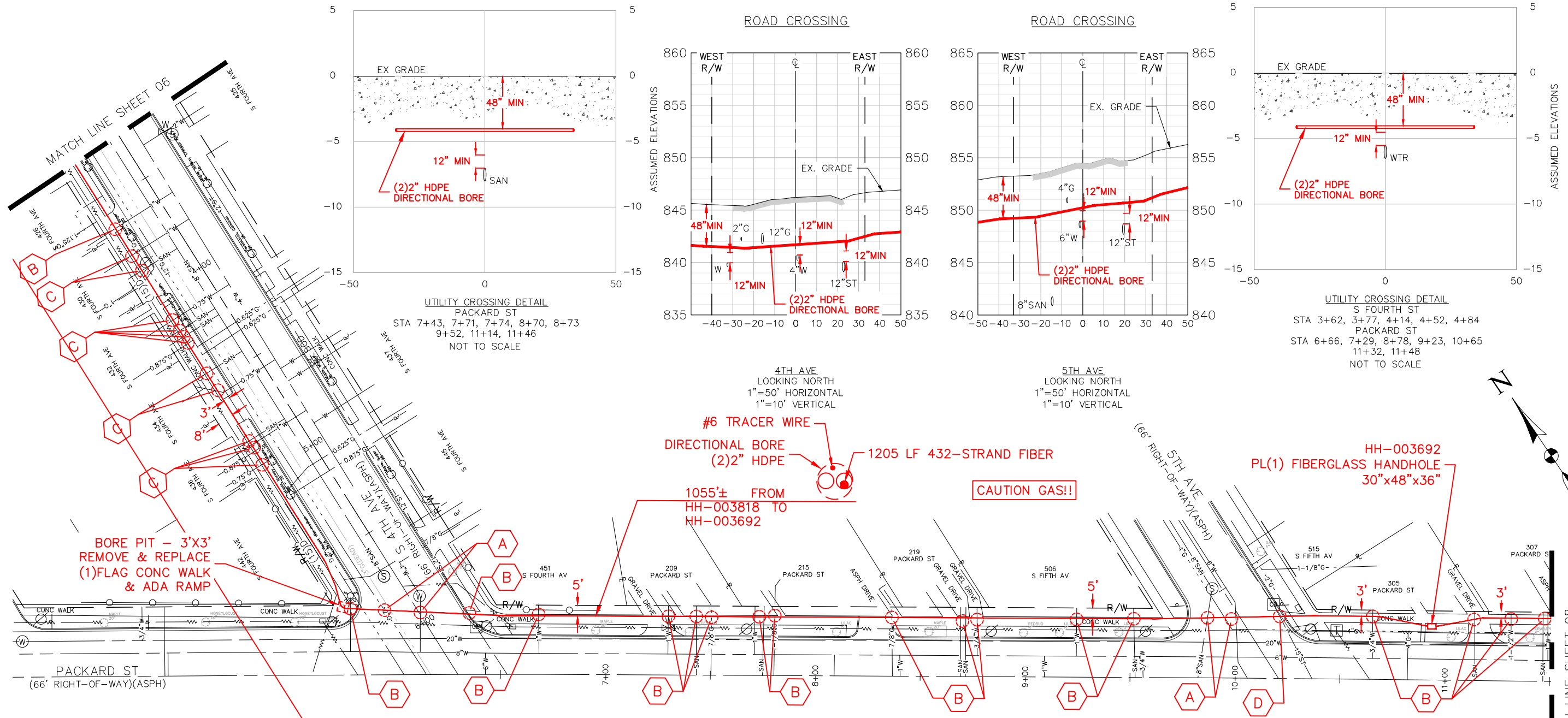

4TH AVE  
LOOKING NORTH  
1"=50' HORIZONTAL  
1"=10' VERTICAL

#6 TRACER WIRE  
DIRECTIONAL BORE  
(2)2" HDPE

1055± FROM  
HH-003818 TO  
HH-003692

1205 LF 432-STRAND FIBER

**CAUTION GAS!!**

**INCREASE DEPTH OF BORE TO 72" WHEN NOT UNDER SIDEWALK TO AVOID ROOT ZONE OF TREES**

- UTILITY CROSSING/POTHOLE NOTES**
- A** POTHOLE. REMOVE & REPLACE (1) SQFT ASPH ROAD.
  - B** POTHOLE. REMOVE & REPLACE (1) FLAG CONC WALK.
  - C** POTHOLE. REMOVE & REPLACE GREENBELT.
  - D** NO POTHOLE NECESSARY. UTILITY DEPTH TO BE VERIFIED AT NEAREST STRUCTURE.

REVISION		
REV #	DATE	DESCRIPTION
01	7/14/23	REVISED PER CITY OF ANN ARBOR COMMENTS
02	8/24/23	REVISED PER CITY OF ANN ARBOR COMMENTS
03	8/28/23	REVISED PER CITY OF ANN ARBOR COMMENTS
04	9/19/23	REVISED TO AVOID WATER VALVE SHTS 21 & 24



THE LOCATIONS OF EXISTING UNDERGROUND UTILITIES ARE SHOWN IN AN APPROXIMATE WAY ONLY AND HAVE NOT BEEN INDEPENDENTLY VERIFIED. THE CONTRACTOR SHALL DETERMINE THE EXACT LOCATION OF ALL EXISTING UTILITIES BEFORE COMMENCING WORK, AND AGREES TO BE FULLY RESPONSIBLE FOR ANY AND ALL DAMAGES WHICH MIGHT BE OCCASIONED BY THE CONTRACTOR'S FAILURE TO EXACTLY LOCATE AND PRESERVE ANY AND ALL UNDERGROUND UTILITIES.

**METRO ENGINEERING SOLUTIONS**  
33900 SCHOOLCRAFT RD  
LIVONIA, MICHIGAN 48150  
PHONE: 734.483.1427 FAX: 734.483.3431  
www.metroes.net

SOUTH ROUTE - WEST OF U.S. 23	
MES JOB# 1043-22	DRAWN - KMM
PLOT SCALE = 1" = 50'	CHECKED - JB
PLAN DATE = 5/26/2023	

ANN ARBOR SPARK  
CORRIDOR FIBER OPTIC BACKBONE PROJECT  
ANN ARBOR  
WASHTENAW COUNTY, MI

PERMITS REQUIRED:

<input checked="" type="checkbox"/> CITY OF ANN ARBOR	<input type="checkbox"/> CITY OF YPSILANTI	<input type="checkbox"/> EGLE
<input type="checkbox"/> WASHTENAW COUNTY	<input type="checkbox"/> YPSILANTI TOWNSHIP	<input type="checkbox"/> RR
<input checked="" type="checkbox"/> WASHTENAW COUNTY DRAIN	<input type="checkbox"/> PITTSFIELD TOWNSHIP	<input checked="" type="checkbox"/> MDOT

SHEET INFORMATION

TOTAL SHEETS	SHEET NO.
42	07

K:\2022\1043 JOB FOLDERS\1043-22-0318\DWG\1043-22-0318_DS.dwg: 8/28/2023 10:26 AM;

CITY OF ANN ARBOR  
SEC:29 T:02S R:06E

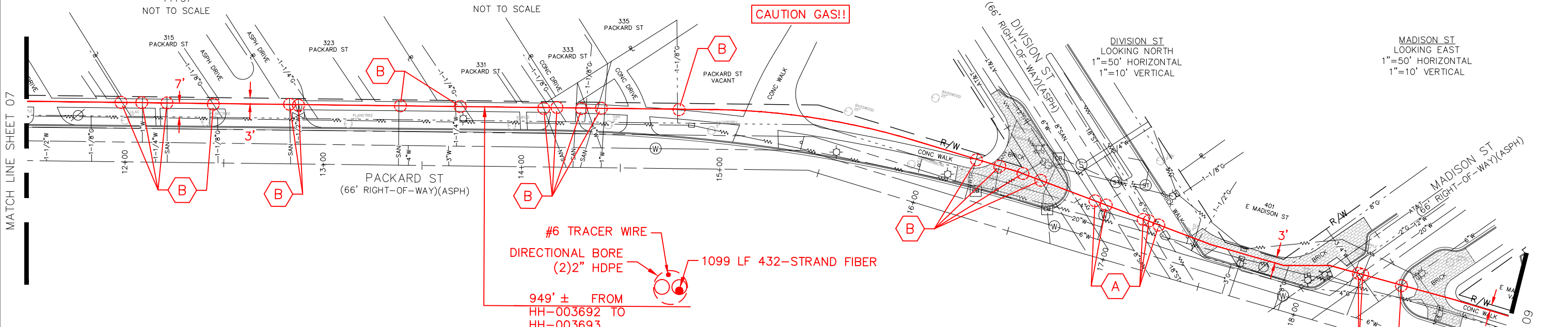
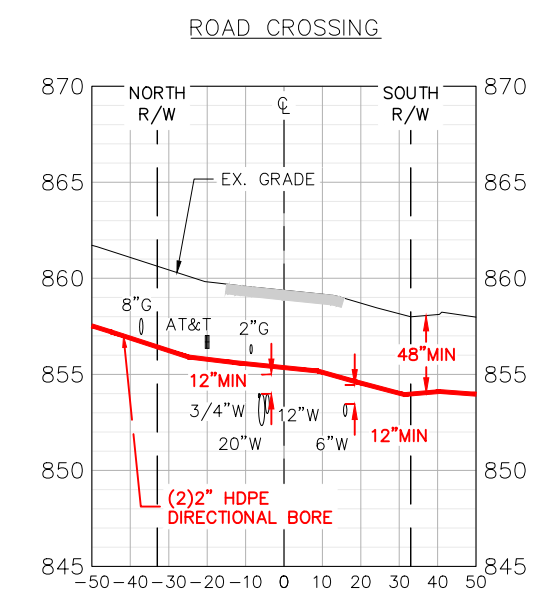
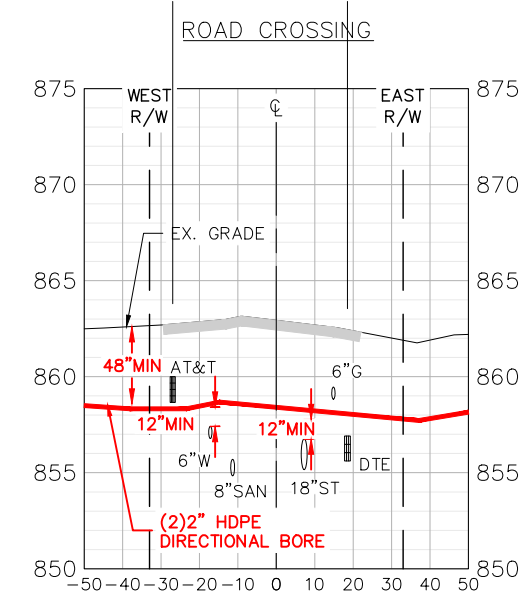
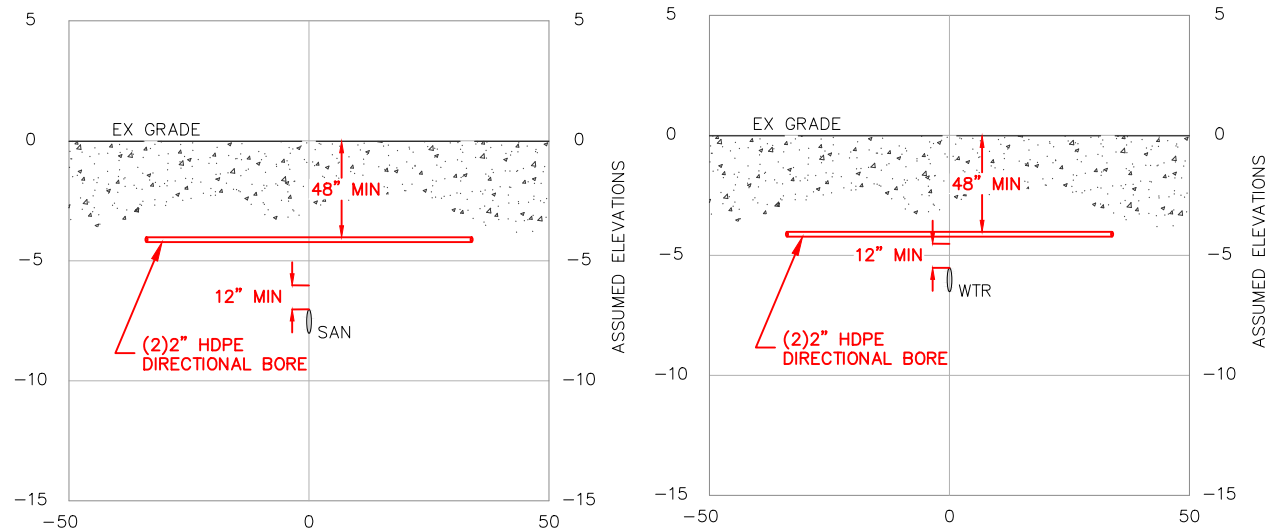

- UTILITY CROSSING/POTHOLE NOTES**
- A** POTHOLE. REMOVE & REPLACE (1) SQFT ASPH ROAD.
  - B** POTHOLE. REMOVE & REPLACE (1) FLAG CONC WALK.
  - C** POTHOLE. REMOVE & REPLACE GREENBELT.
  - D** NO POTHOLE NECESSARY. UTILITY DEPTH TO BE VERIFIED AT NEAREST STRUCTURE.

**811**  
Know what's below.  
Call before you dig.

THE LOCATIONS OF EXISTING UNDERGROUND UTILITIES ARE SHOWN IN AN APPROXIMATE WAY ONLY AND HAVE NOT BEEN INDEPENDENTLY VERIFIED. THE CONTRACTOR SHALL DETERMINE THE EXACT LOCATION OF ALL EXISTING UTILITIES BEFORE COMMENCING WORK, AND AGREES TO BE FULLY RESPONSIBLE FOR ANY AND ALL DAMAGES WHICH MIGHT BE OCCASIONED BY THE CONTRACTOR'S FAILURE TO EXACTLY LOCATE AND PRESERVE ANY AND ALL UNDERGROUND UTILITIES.

**METRO ENGINEERING SOLUTIONS**  
33900 SCHOOLCRAFT RD  
LIVONIA, MICHIGAN 48150  
PHONE: 734.483.1427 FAX: 734.483.3431  
www.metroes.net

SOUTH ROUTE - WEST OF U.S. 23	
MES JOB# 1043-22	DRAWN - KMM
PLOT SCALE = 1" = 50'	CHECKED - JB
PLAN DATE = 5/26/2023	

ANN ARBOR SPARK  
CORRIDOR FIBER OPTIC BACKBONE PROJECT  
ANN ARBOR  
WASHTENAW COUNTY, MI

PERMITS REQUIRED:

<input checked="" type="checkbox"/> CITY OF ANN ARBOR	<input type="checkbox"/> CITY OF YPSILANTI	<input type="checkbox"/> EGLE
<input type="checkbox"/> WASHTENAW COUNTY	<input type="checkbox"/> YPSILANTI TOWNSHIP	<input type="checkbox"/> RR
<input checked="" type="checkbox"/> WASHTENAW COUNTY DRAIN	<input type="checkbox"/> PITTSFIELD TOWNSHIP	<input checked="" type="checkbox"/> MDOT

SHEET INFORMATION

TOTAL SHEETS	SHEET NO.
42	08

REVISION

REV #	DATE	DESCRIPTION
01	7/14/23	REVISED PER CITY OF ANN ARBOR COMMENTS
02	8/24/23	REVISED PER CITY OF ANN ARBOR COMMENTS
03	8/28/23	REVISED PER CITY OF ANN ARBOR COMMENTS
04	9/19/23	REVISED TO AVOID WATER VALVE SHTS 21 & 24

K:\2022\1043-JOB FOLDERS\1043-22-0318\DWG\1043-22-0318_DS.dwg: 8/28/2023 10:26 AM;





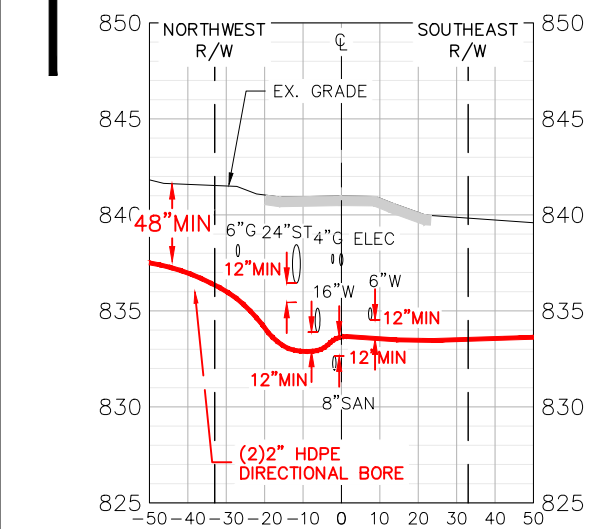
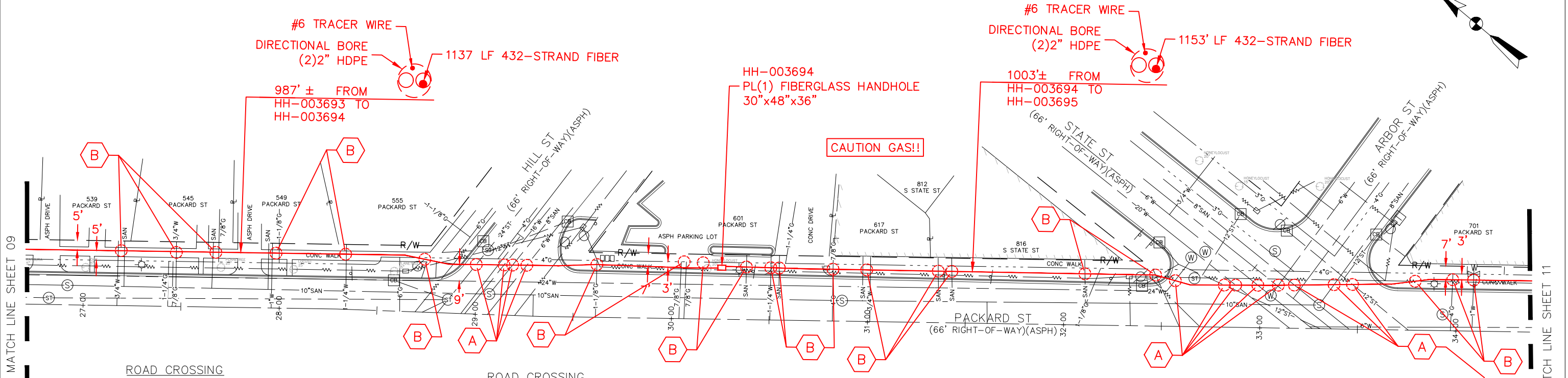
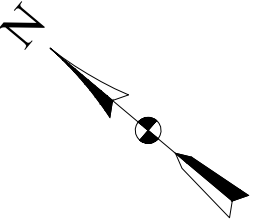

HILL ST  
LOOKING EAST  
1"=50' HORIZONTAL  
1"=10' VERTICAL

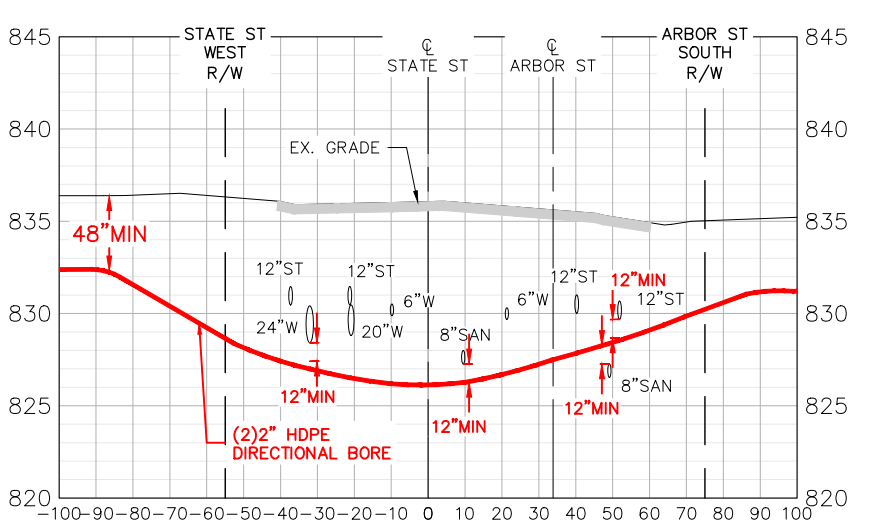

STATE ST AND ARBOR ST  
LOOKING NORTHEAST  
1"=50' HORIZONTAL  
1"=10' VERTICAL

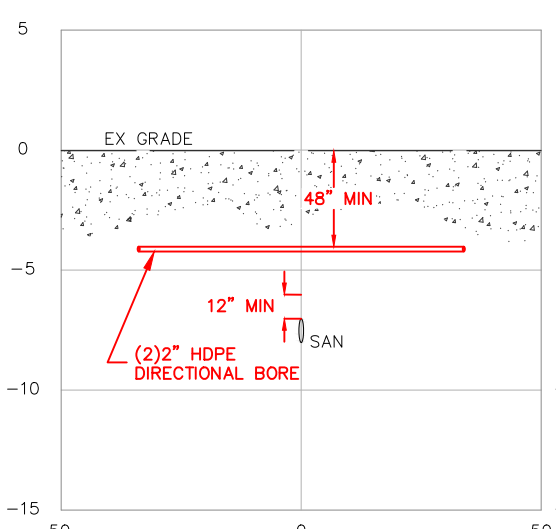

UTILITY CROSSING DETAIL  
PACKARD ST  
STA 30+55, 30+98, 31+36, 31+43, 32+11  
NOT TO SCALE

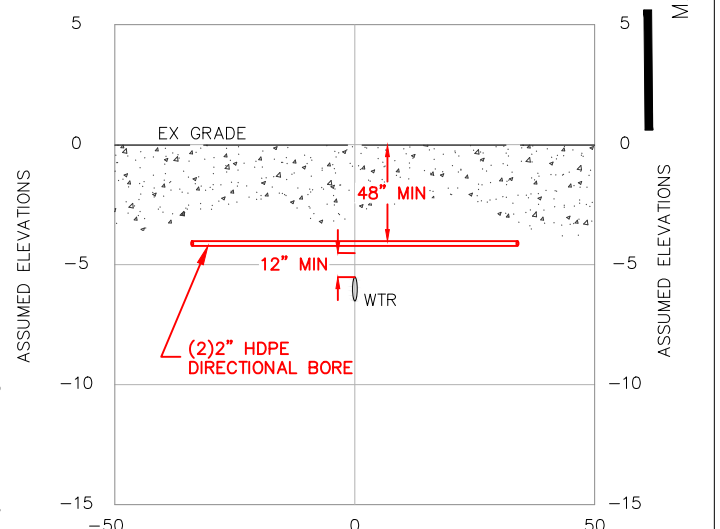

UTILITY CROSSING DETAIL  
PACKARD ST  
STA 27+22, 27+47, 27+96, 28+34,  
30+50, 31+02, 34+08  
NOT TO SCALE

- UTILITY CROSSING/POTHOLE NOTES**
- A** POTHOLE. REMOVE & REPLACE (1) SQFT ASPH ROAD.
  - B** POTHOLE. REMOVE & REPLACE (1) FLAG CONC WALK.
  - C** POTHOLE. REMOVE & REPLACE GREENBELT.
  - D** NO POTHOLE NECESSARY. UTILITY DEPTH TO BE VERIFIED AT NEAREST STRUCTURE.

REVISION		
REV #	DATE	DESCRIPTION
01	7/14/23	REVISED PER CITY OF ANN ARBOR COMMENTS
02	8/24/23	REVISED PER CITY OF ANN ARBOR COMMENTS
03	8/28/23	REVISED PER CITY OF ANN ARBOR COMMENTS
04	9/19/23	REVISED TO AVOID WATER VALVE SHTS 21 & 24



THE LOCATIONS OF EXISTING UNDERGROUND UTILITIES ARE SHOWN IN AN APPROXIMATE WAY ONLY AND HAVE NOT BEEN INDEPENDENTLY VERIFIED. THE CONTRACTOR SHALL DETERMINE THE EXACT LOCATION OF ALL EXISTING UTILITIES BEFORE COMMENCING WORK, AND AGREES TO BE FULLY RESPONSIBLE FOR ANY AND ALL DAMAGES WHICH MIGHT BE OCCASIONED BY THE CONTRACTOR'S FAILURE TO EXACTLY LOCATE AND PRESERVE ANY AND ALL UNDERGROUND UTILITIES.

**METRO ENGINEERING SOLUTIONS**  
33900 SCHOOLCRAFT RD  
LIVONIA, MICHIGAN 48150  
PHONE: 734.483.1427 FAX: 734.483.3431  
www.metroes.net

SOUTH ROUTE - WEST OF U.S. 23	
MES JOB# 1043-22	DRAWN - KMM
PLOT SCALE = 1" = 50'	CHECKED - JB
PLAN DATE = 5/26/2023	

ANN ARBOR SPARK  
CORRIDOR FIBER OPTIC BACKBONE PROJECT  
ANN ARBOR  
WASHTENAW COUNTY, MI

PERMITS REQUIRED:

<input checked="" type="checkbox"/> CITY OF ANN ARBOR	<input type="checkbox"/> CITY OF YPSILANTI	<input type="checkbox"/> EGLE
<input type="checkbox"/> WASHTENAW COUNTY	<input type="checkbox"/> YPSILANTI TOWNSHIP	<input type="checkbox"/> RR
<input checked="" type="checkbox"/> WASHTENAW COUNTY DRAIN	<input type="checkbox"/> PITTSFIELD TOWNSHIP	<input checked="" type="checkbox"/> MDOT

SHEET INFORMATION

TOTAL SHEETS	SHEET NO.
42	10

K:\2022\1043 JOB FOLDERS\1043-22-0318\DWG\1043-22-0318_DS.dwg; 8/28/2023 10:26 AM;

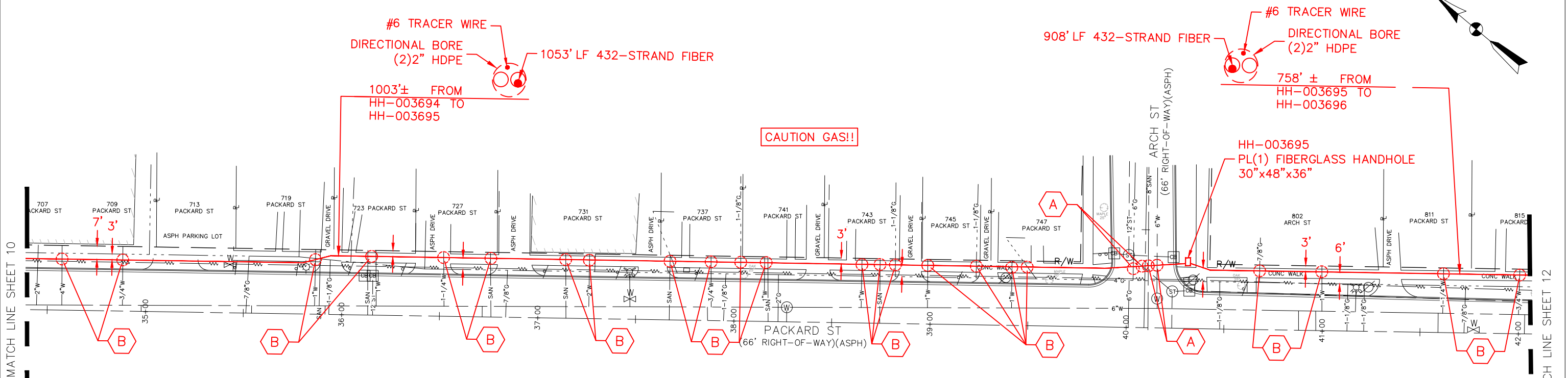
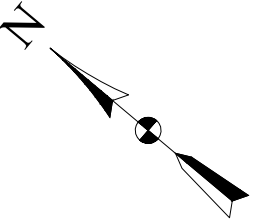

MATCH LINE SHEET 10

MATCH LINE SHEET 12

- UTILITY CROSSING/POTHOLE NOTES**
- A** POTHOLE. REMOVE & REPLACE (1) SQFT ASPH ROAD.
  - B** POTHOLE. REMOVE & REPLACE (1) FLAG CONC WALK.
  - C** POTHOLE. REMOVE & REPLACE GREENBELT.
  - D** NO POTHOLE NECESSARY. UTILITY DEPTH TO BE VERIFIED AT NEAREST STRUCTURE.

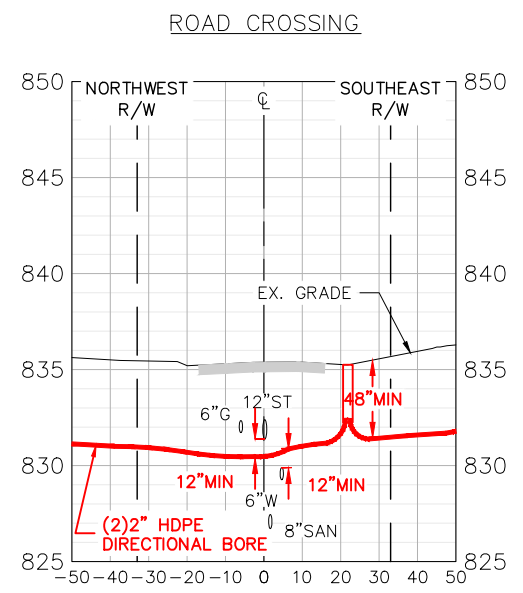

ARCH ST  
LOOKING NORTHEAST  
1"=50' HORIZONTAL  
1"=10' VERTICAL

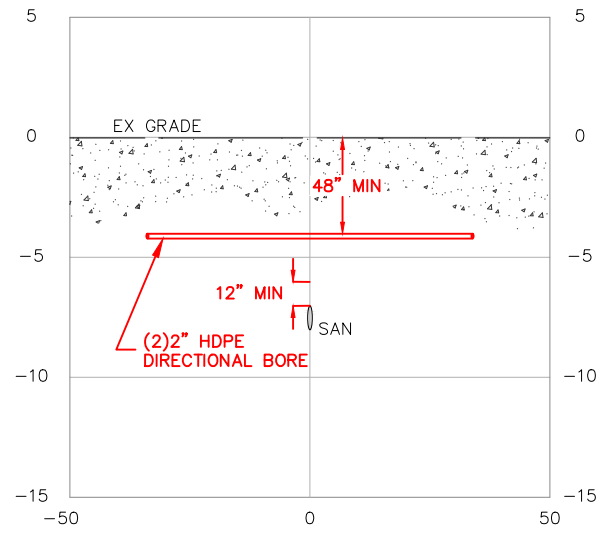

**UTILITY CROSSING DETAIL**  
PACKARD ST  
STA 36+13, 36+76, 37+14, 37+64, 38+17  
38+74  
NOT TO SCALE

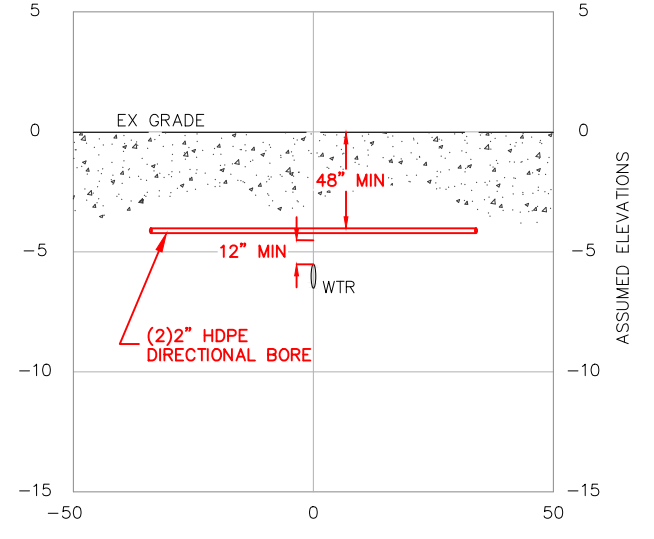

**UTILITY CROSSING DETAIL**  
PACKARD ST  
STA 34+57, 34+89, 35+86, 36+18,  
36+52, 37+27, 37+88, 38+14, 38+63,  
38+98, 39+41, 41+00, 41+61, 42+00  
NOT TO SCALE

REV #	DATE	DESCRIPTION
01	7/14/23	REVISED PER CITY OF ANN ARBOR COMMENTS
02	8/24/23	REVISED PER CITY OF ANN ARBOR COMMENTS
03	8/28/23	REVISED PER CITY OF ANN ARBOR COMMENTS
04	9/19/23	REVISED TO AVOID WATER VALVE SHTS 21 & 24

THE LOCATIONS OF EXISTING UNDERGROUND UTILITIES ARE SHOWN IN AN APPROXIMATE WAY ONLY AND HAVE NOT BEEN INDEPENDENTLY VERIFIED. THE CONTRACTOR SHALL DETERMINE THE EXACT LOCATION OF ALL EXISTING UTILITIES BEFORE COMMENCING WORK, AND AGREES TO BE FULLY RESPONSIBLE FOR ANY AND ALL DAMAGES WHICH MIGHT BE OCCASIONED BY THE CONTRACTOR'S FAILURE TO EXACTLY LOCATE AND PRESERVE ANY AND ALL UNDERGROUND UTILITIES.

 33900 SCHOOLCRAFT RD LIVONIA, MICHIGAN 48150 PHONE: 734.483.1427 FAX: 734.483.3431 www.metroes.net	SOUTH ROUTE - WEST OF U.S. 23		ANN ARBOR SPARK		PERMITS REQUIRED:			SHEET INFORMATION			
	MES JOB#	1043-22	DRAWN	KMM	CORRIDOR FIBER OPTIC BACKBONE PROJECT		<input checked="" type="checkbox"/> CITY OF ANN ARBOR	<input type="checkbox"/> CITY OF YPSILANTI	<input type="checkbox"/> EGLE	TOTAL SHEETS	SHEET NO.
	PLOT SCALE	= 1" = 50'	CHECKED	JB	ANN ARBOR WASHTENAW COUNTY, MI		<input type="checkbox"/> WASHTENAW COUNTY	<input type="checkbox"/> YPSILANTI TOWNSHIP	<input type="checkbox"/> RR		
PLAN DATE	= 5/26/2023					<input checked="" type="checkbox"/> WASHTENAW COUNTY DRAIN	<input type="checkbox"/> PITTSFIELD TOWNSHIP	<input checked="" type="checkbox"/> MDOT		42	11

K:\2022\1043 JOB FOLDERS\1043-22-0318\DWG\1043-22-0318_DS.dwg: 8/28/2023 10:26 AM;

CITY OF ANN ARBOR  
SEC:29 T:02S R:06E

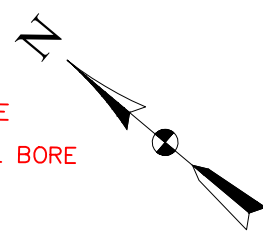

- UTILITY CROSSING/POTHOLE NOTES**
- A** POTHOLE. REMOVE & REPLACE (1) SQFT ASPH ROAD.
  - B** POTHOLE. REMOVE & REPLACE (1) FLAG CONC WALK.
  - C** POTHOLE. REMOVE & REPLACE GREENBELT.
  - D** NO POTHOLE NECESSARY. UTILITY DEPTH TO BE VERIFIED AT NEAREST STRUCTURE.

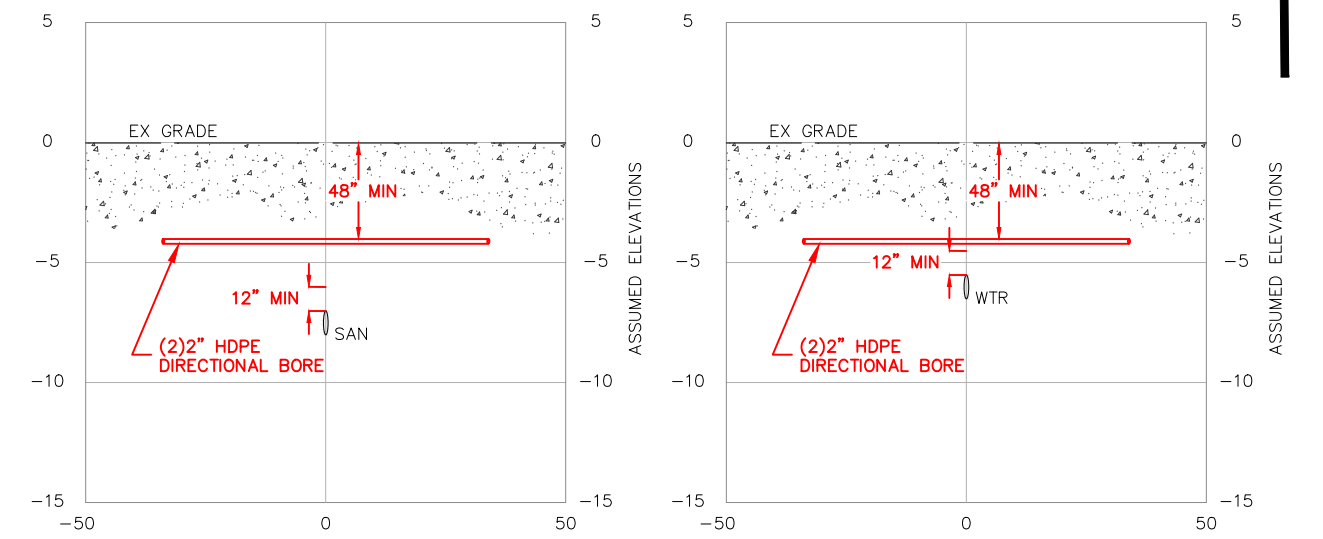
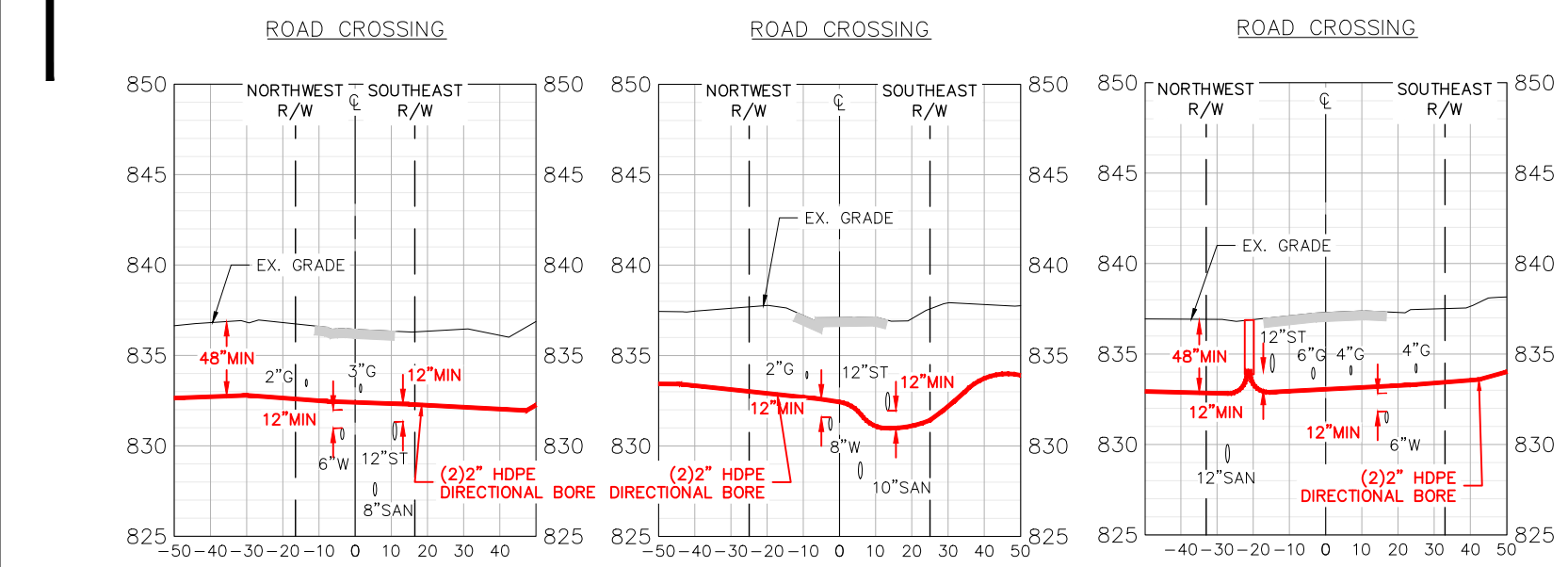
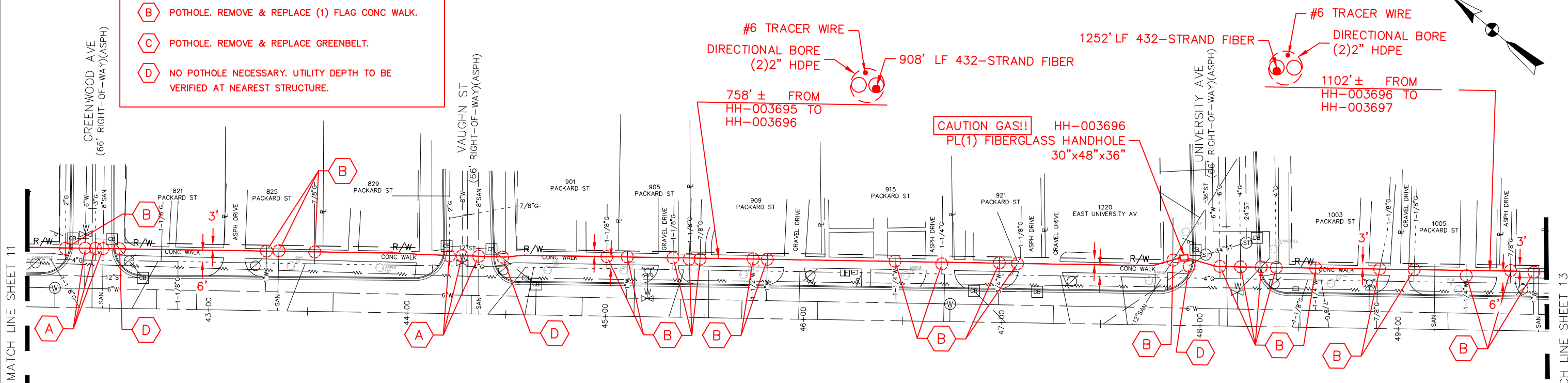

**811**  
Know what's below.  
Call before you dig.

THE LOCATIONS OF EXISTING UNDERGROUND UTILITIES ARE SHOWN IN AN APPROXIMATE WAY ONLY AND HAVE NOT BEEN INDEPENDENTLY VERIFIED. THE CONTRACTOR SHALL DETERMINE THE EXACT LOCATION OF ALL EXISTING UTILITIES BEFORE COMMENCING WORK, AND AGREES TO BE FULLY RESPONSIBLE FOR ANY AND ALL DAMAGES WHICH MIGHT BE OCCASIONED BY THE CONTRACTOR'S FAILURE TO EXACTLY LOCATE AND PRESERVE ANY AND ALL UNDERGROUND UTILITIES.

**METRO ENGINEERING SOLUTIONS**  
33900 SCHOOLCRAFT RD  
LIVONIA, MICHIGAN 48150  
PHONE: 734.483.1427 FAX: 734.483.3431  
www.metroes.net

SOUTH ROUTE - WEST OF U.S. 23	
MES JOB# 1043-22	DRAWN - KMM
PLOT SCALE = 1" = 50'	CHECKED - JB
PLAN DATE = 5/26/2023	

ANN ARBOR SPARK  
CORRIDOR FIBER OPTIC BACKBONE PROJECT  
ANN ARBOR  
WASHTENAW COUNTY, MI

PERMITS REQUIRED:

<input checked="" type="checkbox"/> CITY OF ANN ARBOR	<input type="checkbox"/> CITY OF YPSILANTI	<input type="checkbox"/> EGLE
<input type="checkbox"/> WASHTENAW COUNTY	<input type="checkbox"/> YPSILANTI TOWNSHIP	<input type="checkbox"/> RR
<input checked="" type="checkbox"/> WASHTENAW COUNTY DRAIN	<input type="checkbox"/> PITTSFIELD TOWNSHIP	<input checked="" type="checkbox"/> MDOT

SHEET INFORMATION

TOTAL SHEETS	SHEET NO.
42	12

REVISION

REV #	DATE	DESCRIPTION
01	7/14/23	REVISED PER CITY OF ANN ARBOR COMMENTS
02	8/24/23	REVISED PER CITY OF ANN ARBOR COMMENTS
03	8/28/23	REVISED PER CITY OF ANN ARBOR COMMENTS
04	9/19/23	REVISED TO AVOID WATER VALVE SHTS 21 & 24

K:\2022\1043-JOB FOLDERS\1043-22-0318\DWG\1043-22-0318_DS.dwg: 8/28/2023 10:26 AM;

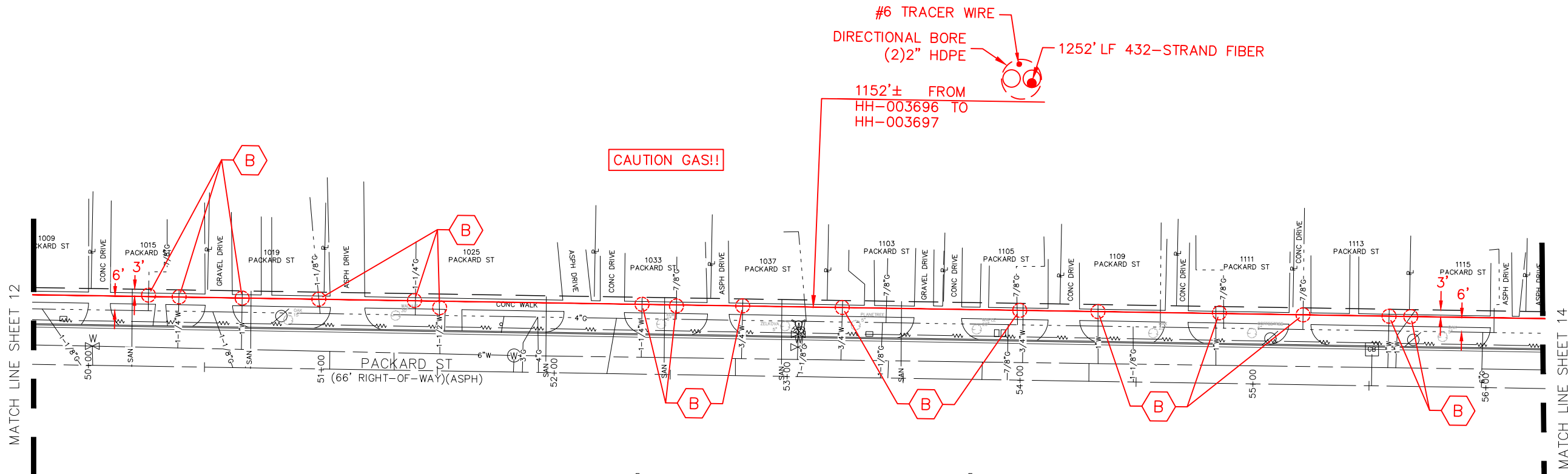
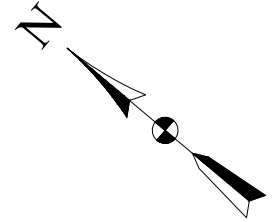

CAUTION GAS!!

#6 TRACER WIRE  
DIRECTIONAL BORE  
(2)2" HDPE  
1252' LF 432-STRAND FIBER  
1152'± FROM  
HH-003696 TO  
HH-003697

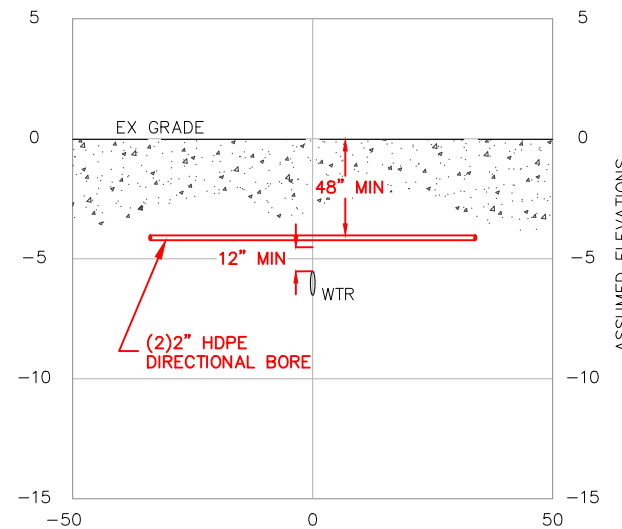

UTILITY CROSSING DETAIL  
PACKARD ST  
STA 50+38, 50+64, 51+52, 52+37,  
52+80, 53+23, 54+02, 54+33, 54+84,  
55+57, 55+64  
NOT TO SCALE

- UTILITY CROSSING/POTHOLE NOTES**
- A** POT HOLE. REMOVE & REPLACE (1) SQFT ASPH ROAD.
  - B** POT HOLE. REMOVE & REPLACE (1) FLAG CONC WALK.
  - C** POT HOLE. REMOVE & REPLACE GREENBELT.
  - D** NO POT HOLE NECESSARY. UTILITY DEPTH TO BE VERIFIED AT NEAREST STRUCTURE.



THE LOCATIONS OF EXISTING UNDERGROUND UTILITIES ARE SHOWN IN AN APPROXIMATE WAY ONLY AND HAVE NOT BEEN INDEPENDENTLY VERIFIED. THE CONTRACTOR SHALL DETERMINE THE EXACT LOCATION OF ALL EXISTING UTILITIES BEFORE COMMENCING WORK, AND AGREES TO BE FULLY RESPONSIBLE FOR ANY AND ALL DAMAGES WHICH MIGHT BE OCCASIONED BY THE CONTRACTOR'S FAILURE TO EXACTLY LOCATE AND PRESERVE ANY AND ALL UNDERGROUND UTILITIES.

REVISION		
REV #	DATE	DESCRIPTION
01	7/14/23	REVISED PER CITY OF ANN ARBOR COMMENTS
02	8/24/23	REVISED PER CITY OF ANN ARBOR COMMENTS
03	8/28/23	REVISED PER CITY OF ANN ARBOR COMMENTS
04	9/19/23	REVISED TO AVOID WATER VALVE SHTS 21 & 24

**METRO ENGINEERING SOLUTIONS**  
33900 SCHOOLCRAFT RD  
LIVONIA, MICHIGAN 48150  
PHONE: 734.483.1427 FAX: 734.483.3431  
www.metroes.net

SOUTH ROUTE - WEST OF U.S. 23	
MES JOB# 1043-22	DRAWN - KMM
PLOT SCALE = 1" = 50'	CHECKED - JB
PLAN DATE = 5/26/2023	

ANN ARBOR SPARK  
CORRIDOR FIBER OPTIC BACKBONE PROJECT  
ANN ARBOR  
WASHTENAW COUNTY, MI

PERMITS REQUIRED:

<input checked="" type="checkbox"/> CITY OF ANN ARBOR	<input type="checkbox"/> CITY OF YPSILANTI	<input type="checkbox"/> EGLE
<input type="checkbox"/> WASHTENAW COUNTY	<input type="checkbox"/> YPSILANTI TOWNSHIP	<input type="checkbox"/> RR
<input checked="" type="checkbox"/> WASHTENAW COUNTY DRAIN	<input type="checkbox"/> PITTSFIELD TOWNSHIP	<input checked="" type="checkbox"/> MDOT

SHEET INFORMATION

TOTAL SHEETS	SHEET NO.
42	13

K:\2022\1043 JOB FOLDERS\1043-22-0318\DWG\1043-22-0318_DS.dwg: 8/28/2023 10:26 AM;



CITY OF ANN ARBOR  
SEC:29 T:02S R:06E

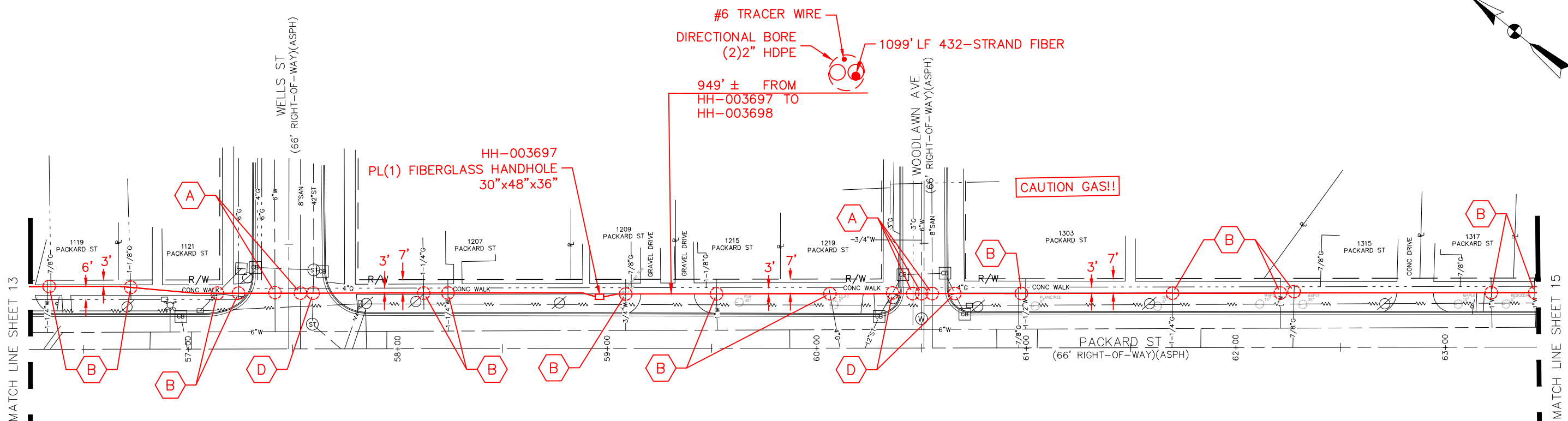
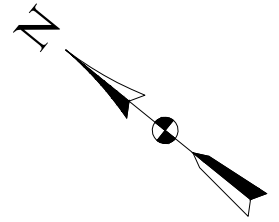

ROAD CROSSING

ROAD CROSSING

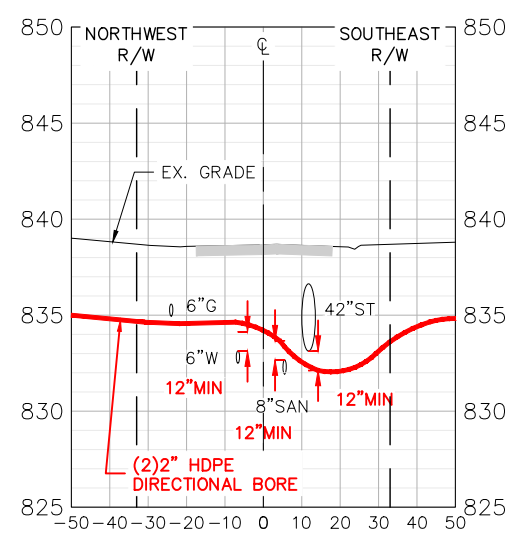

WELLS ST  
LOOKING NORTHEAST  
1"=50' HORIZONTAL  
1"=10' VERTICAL

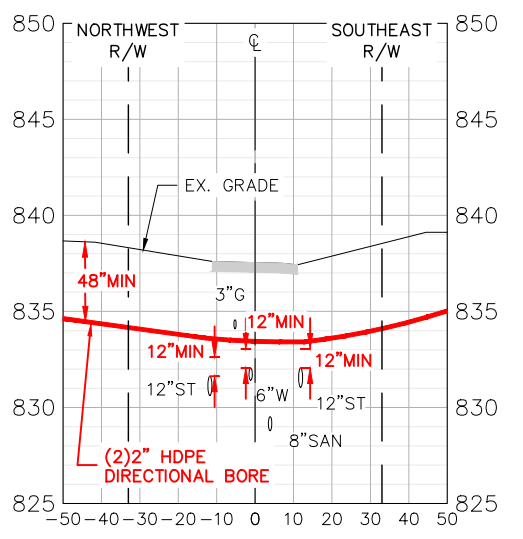

WOODLAWN AVE  
LOOKING NORTHEAST  
1"=50' HORIZONTAL  
1"=10' VERTICAL

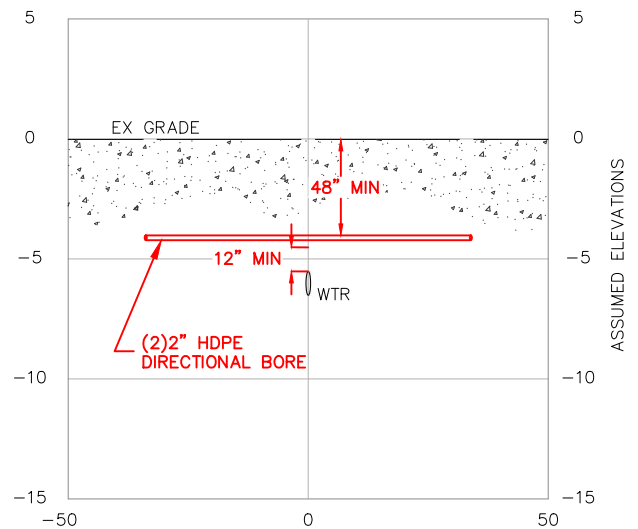

UTILITY CROSSING DETAIL

PACKARD ST  
STA 56+33, 58+23, 59+09, 59+52,  
61+00, 62+21, 63+22, 63+44

- UTILITY CROSSING/POTHOLE NOTES**
- A** POTHOLE. REMOVE & REPLACE (1) SQFT ASPH ROAD.
  - B** POTHOLE. REMOVE & REPLACE (1) FLAG CONC WALK.
  - C** POTHOLE. REMOVE & REPLACE GREENBELT.
  - D** NO POTHOLE NECESSARY. UTILITY DEPTH TO BE VERIFIED AT NEAREST STRUCTURE.

**811**  
Know what's below.  
Call before you dig.

THE LOCATIONS OF EXISTING UNDERGROUND UTILITIES ARE SHOWN IN AN APPROXIMATE WAY ONLY AND HAVE NOT BEEN INDEPENDENTLY VERIFIED. THE CONTRACTOR SHALL DETERMINE THE EXACT LOCATION OF ALL EXISTING UTILITIES BEFORE COMMENCING WORK, AND AGREES TO BE FULLY RESPONSIBLE FOR ANY AND ALL DAMAGES WHICH MIGHT BE OCCASIONED BY THE CONTRACTOR'S FAILURE TO EXACTLY LOCATE AND PRESERVE ANY AND ALL UNDERGROUND UTILITIES.

**METRO ENGINEERING SOLUTIONS**  
33900 SCHOOLCRAFT RD  
LIVONIA, MICHIGAN 48150  
PHONE: 734.483.1427 FAX: 734.483.3431  
www.metroes.net

SOUTH ROUTE - WEST OF U.S. 23	
MES JOB# 1043-22	DRAWN - KMM
PLOT SCALE = 1" = 50'	CHECKED - JB
PLAN DATE = 5/26/2023	

ANN ARBOR SPARK  
CORRIDOR FIBER OPTIC BACKBONE PROJECT  
ANN ARBOR  
WASHTENAW COUNTY, MI

PERMITS REQUIRED:

<input checked="" type="checkbox"/> CITY OF ANN ARBOR	<input type="checkbox"/> CITY OF YPSILANTI	<input type="checkbox"/> EGLE
<input type="checkbox"/> WASHTENAW COUNTY	<input type="checkbox"/> YPSILANTI TOWNSHIP	<input type="checkbox"/> RR
<input checked="" type="checkbox"/> WASHTENAW COUNTY DRAIN	<input type="checkbox"/> PITTSFIELD TOWNSHIP	<input checked="" type="checkbox"/> MDOT

SHEET INFORMATION

TOTAL SHEETS	SHEET NO.
42	14

REVISION

REV #	DATE NOT TO SCALE	DESCRIPTION
01	7/14/23	REVISED PER CITY OF ANN ARBOR COMMENTS
02	8/24/23	REVISED PER CITY OF ANN ARBOR COMMENTS
03	8/28/23	REVISED PER CITY OF ANN ARBOR COMMENTS
04	9/19/23	REVISED TO AVOID WATER VALVE SHTS 21 & 24

K:\2022\1043 JOB FOLDERS\1043-22-0318\DWG\1043-22-0318_DS.dwg: 8/28/2023 10:26 AM;



CITY OF ANN ARBOR  
SEC: 29 T: 02S R: 06E

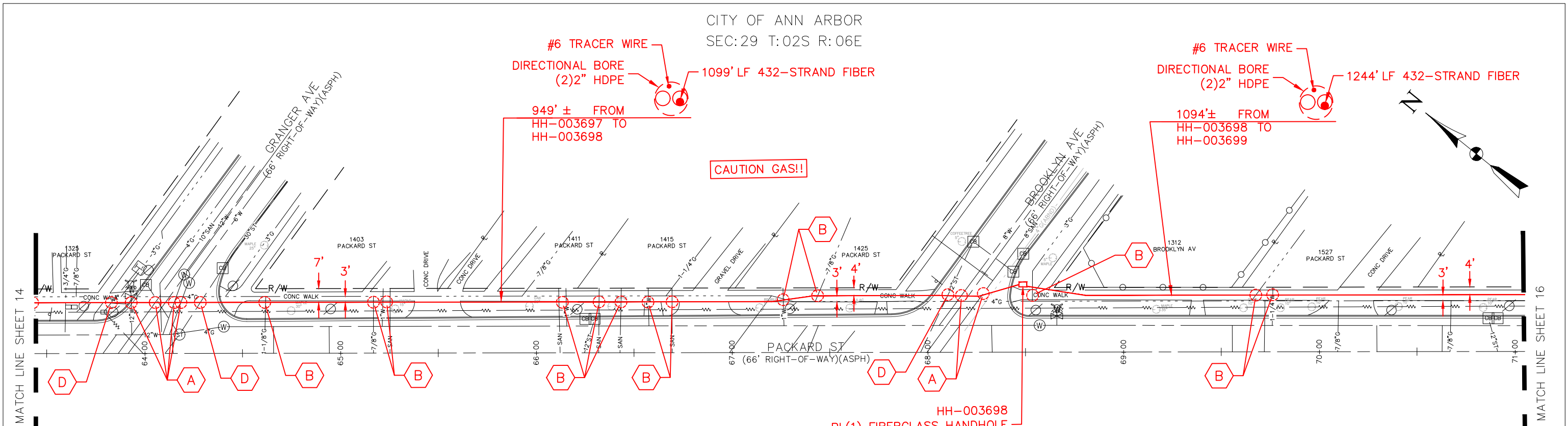

ROAD CROSSING

ROAD CROSSING

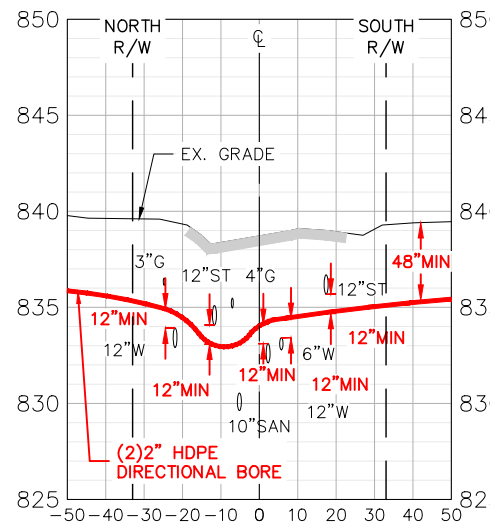

GRANGER AVE  
LOOKING EAST  
1"=50' HORIZONTAL  
1"=10' VERTICAL

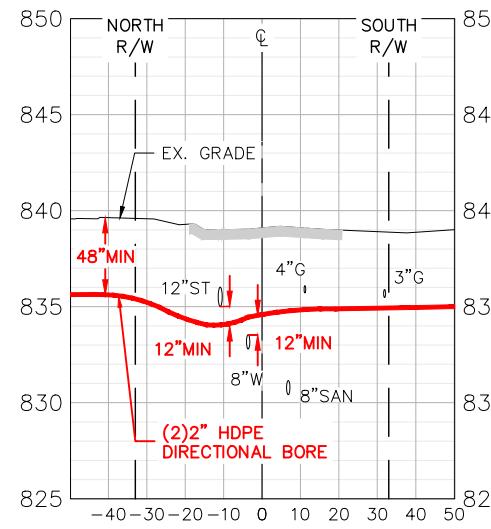

BROOKLYN AVE  
LOOKING EAST  
1"=50' HORIZONTAL  
1"=10' VERTICAL

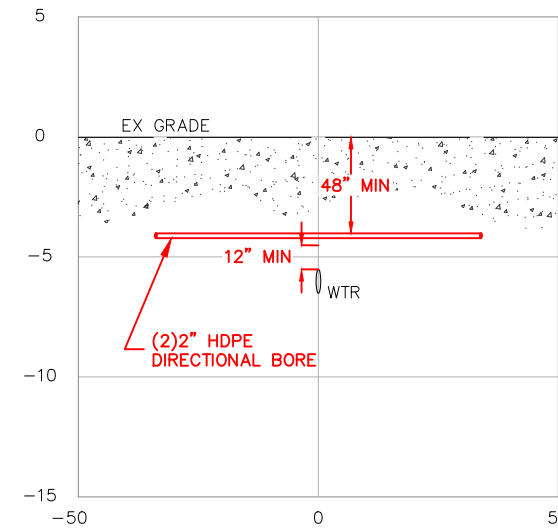

UTILITY CROSSING DETAIL  
PACKARD ST  
STA 65+21, 66+15, 66+57, 66+70,  
67+22, 69+26  
NOT TO SCALE

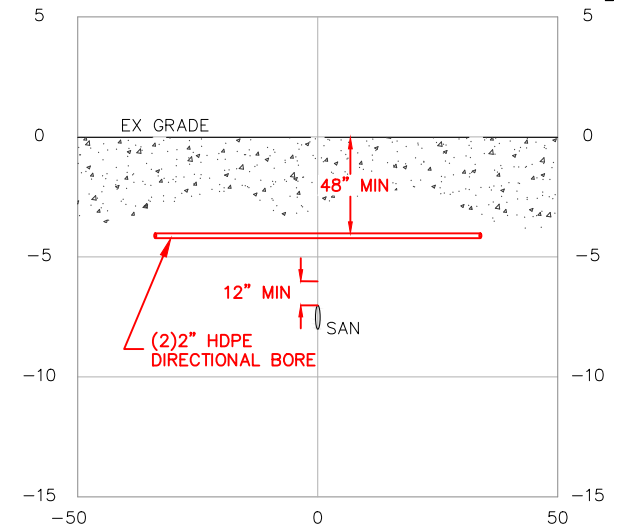

UTILITY CROSSING DETAIL  
PACKARD ST  
STA 65+25, 66+12, 66+31, 66+42

- UTILITY CROSSING/POTHOLE NOTES
- A** POTHOLE. REMOVE & REPLACE (1) SQFT ASPH ROAD.
  - B** POTHOLE. REMOVE & REPLACE (1) FLAG CONC WALK.
  - C** POTHOLE. REMOVE & REPLACE GREENBELT.
  - D** NO POTHOLE NECESSARY. UTILITY DEPTH TO BE VERIFIED AT NEAREST STRUCTURE.



THE LOCATIONS OF EXISTING UNDERGROUND UTILITIES ARE SHOWN IN AN APPROXIMATE WAY ONLY AND HAVE NOT BEEN INDEPENDENTLY VERIFIED. THE CONTRACTOR SHALL DETERMINE THE EXACT LOCATION OF ALL EXISTING UTILITIES BEFORE COMMENCING WORK, AND AGREES TO BE FULLY RESPONSIBLE FOR ANY AND ALL DAMAGES WHICH MIGHT BE OCCASIONED BY THE CONTRACTOR'S FAILURE TO EXACTLY LOCATE AND PRESERVE ANY AND ALL UNDERGROUND UTILITIES.

**METRO ENGINEERING SOLUTIONS**  
33900 SCHOOLCRAFT RD  
LIVONIA, MICHIGAN 48150  
PHONE: 734.483.1427 FAX: 734.483.3431  
www.metroes.net

SOUTH ROUTE - WEST OF U.S. 23	
MES JOB#	1043-22
DRAWN	KMM
PLOT SCALE	1" = 50'
CHECKED	JB
PLAN DATE	5/26/2023

ANN ARBOR SPARK  
CORRIDOR FIBER OPTIC BACKBONE PROJECT  
ANN ARBOR  
WASHTENAW COUNTY, MI

PERMITS REQUIRED:

<input checked="" type="checkbox"/> CITY OF ANN ARBOR	<input type="checkbox"/> CITY OF YPSILANTI	<input type="checkbox"/> EGLE
<input type="checkbox"/> WASHTENAW COUNTY	<input type="checkbox"/> YPSILANTI TOWNSHIP	<input type="checkbox"/> RR
<input checked="" type="checkbox"/> WASHTENAW COUNTY DRAIN	<input type="checkbox"/> PITTSFIELD TOWNSHIP	<input checked="" type="checkbox"/> MDOT

SHEET INFORMATION

TOTAL SHEETS	SHEET NO.
42	15

K:\2022\1043 JOB FOLDERS\1043-22-0318\DWG\1043-22-0318_DS.dwg; 8/28/2023 10:26 AM;

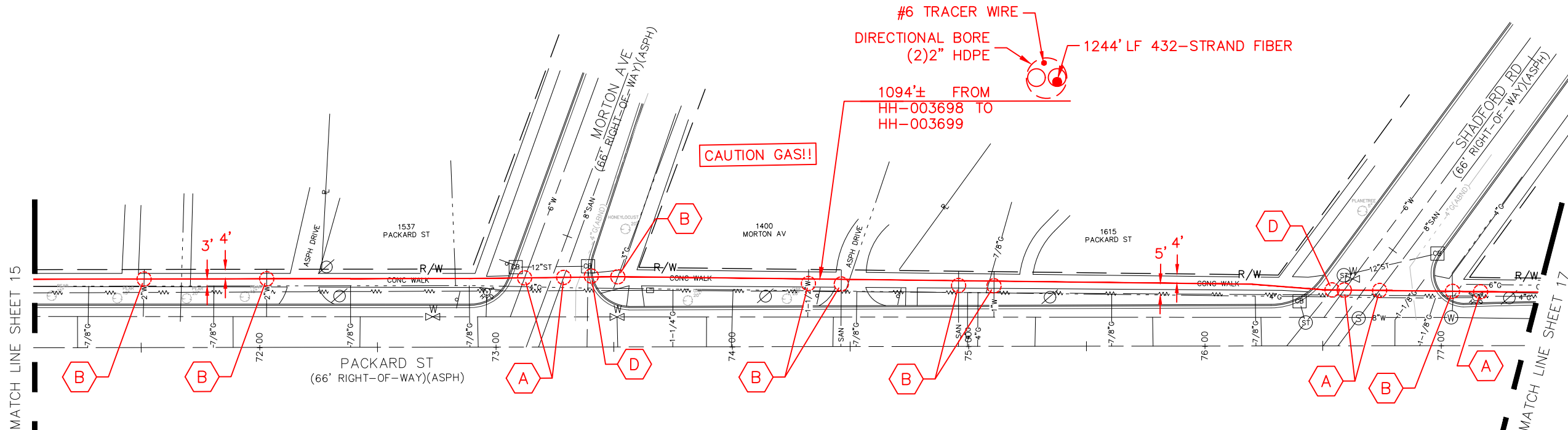
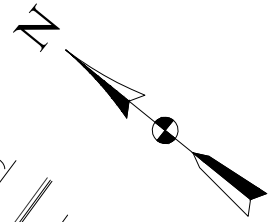

**CAUTION GAS!!**

#6 TRACER WIRE  
DIRECTIONAL BORE  
(2)2" HDPE  
1244' LF 432-STRAND FIBER  
1094± FROM  
HH-003698 TO  
HH-003699

MATCH LINE SHEET 15

MATCH LINE SHEET 17

ROAD CROSSING

ROAD CROSSING

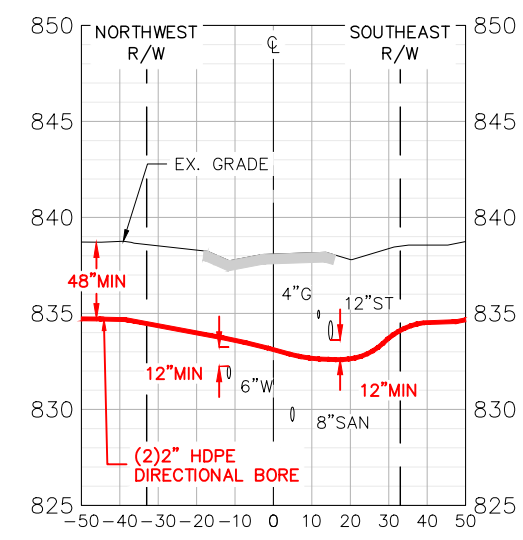

MORTON AVE  
LOOKING NORTHEAST  
1"=50' HORIZONTAL  
1"=10' VERTICAL

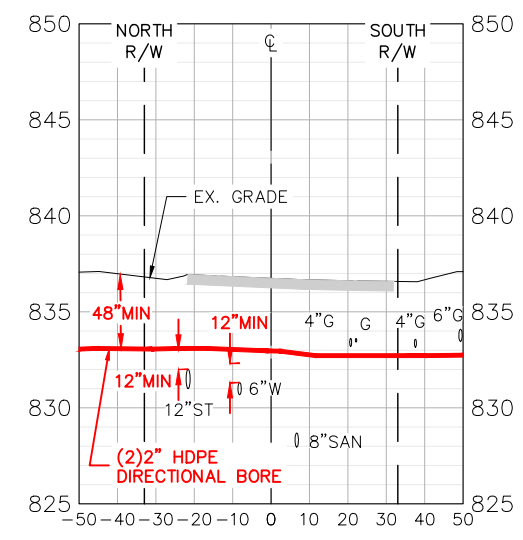

SHADFORD RD  
LOOKING EAST  
1"=50' HORIZONTAL  
1"=10' VERTICAL

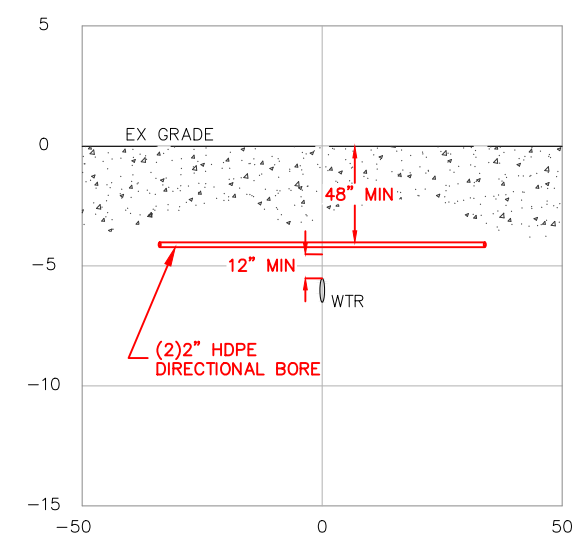

UTILITY CROSSING DETAIL  
PACKARD ST  
STA 71+51, 72+04, 74+32, 75+11

NOT TO SCALE

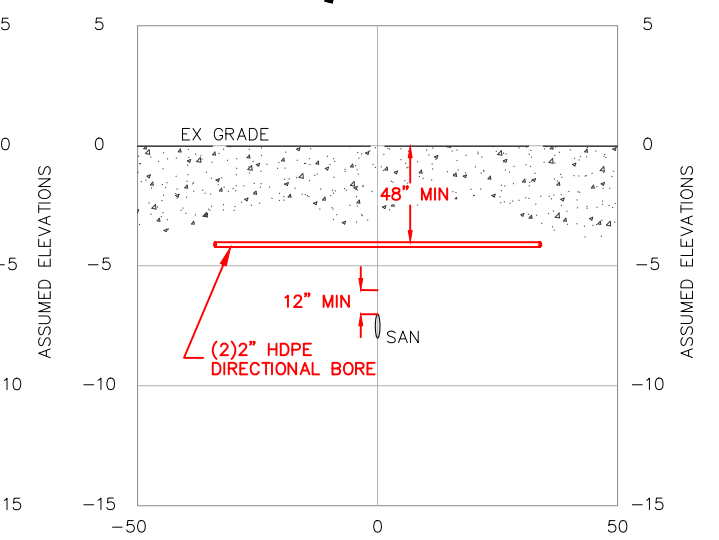

UTILITY CROSSING DETAIL  
PACKARD ST  
STA 74+46, 74+96

NOT TO SCALE  
REVISION

- UTILITY CROSSING/POTHOLE NOTES**
- A** POTHOLE. REMOVE & REPLACE (1) SQFT ASPH ROAD.
  - B** POTHOLE. REMOVE & REPLACE (1) FLAG CONC WALK.
  - C** POTHOLE. REMOVE & REPLACE GREENBELT.
  - D** NO POTHOLE NECESSARY. UTILITY DEPTH TO BE VERIFIED AT NEAREST STRUCTURE.



THE LOCATIONS OF EXISTING UNDERGROUND UTILITIES ARE SHOWN IN AN APPROXIMATE WAY ONLY AND HAVE NOT BEEN INDEPENDENTLY VERIFIED. THE CONTRACTOR SHALL DETERMINE THE EXACT LOCATION OF ALL EXISTING UTILITIES BEFORE COMMENCING WORK, AND AGREES TO BE FULLY RESPONSIBLE FOR ANY AND ALL DAMAGES WHICH MIGHT BE OCCASIONED BY THE CONTRACTOR'S FAILURE TO EXACTLY LOCATE AND PRESERVE ANY AND ALL UNDERGROUND UTILITIES.

**METRO ENGINEERING SOLUTIONS**  
33900 SCHOOLCRAFT RD  
LIVONIA, MICHIGAN 48150  
PHONE: 734.483.1427 FAX: 734.483.3431  
www.metroes.net

SOUTH ROUTE - WEST OF U.S. 23	
MES JOB#	1043-22
DRAWN	KMM
PLOT SCALE	1" = 50'
CHECKED	JB
PLAN DATE	5/26/2023

ANN ARBOR SPARK  
CORRIDOR FIBER OPTIC BACKBONE PROJECT  
ANN ARBOR  
WASHTENAW COUNTY, MI

PERMITS REQUIRED:

<input checked="" type="checkbox"/> CITY OF ANN ARBOR	<input type="checkbox"/> CITY OF YPSILANTI	<input type="checkbox"/> EGLE
<input type="checkbox"/> WASHTENAW COUNTY	<input type="checkbox"/> YPSILANTI TOWNSHIP	<input type="checkbox"/> RR
<input checked="" type="checkbox"/> WASHTENAW COUNTY DRAIN	<input type="checkbox"/> PITTSFIELD TOWNSHIP	<input checked="" type="checkbox"/> MDOT

SHEET INFORMATION

TOTAL SHEETS	42	SHEET NO.	16
--------------	----	-----------	----

K:\2022\1043-JOB FOLDERS\1043-22-0318\DWG\1043-22-0318_DS.dwg: 8/28/2023 10:26 AM;

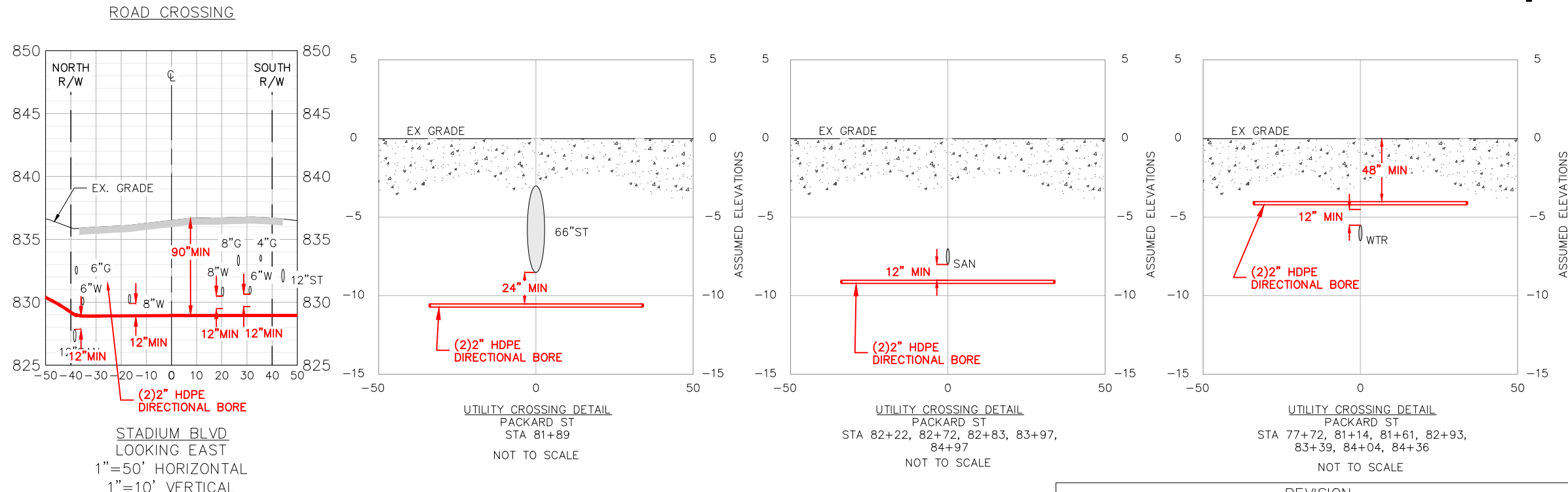
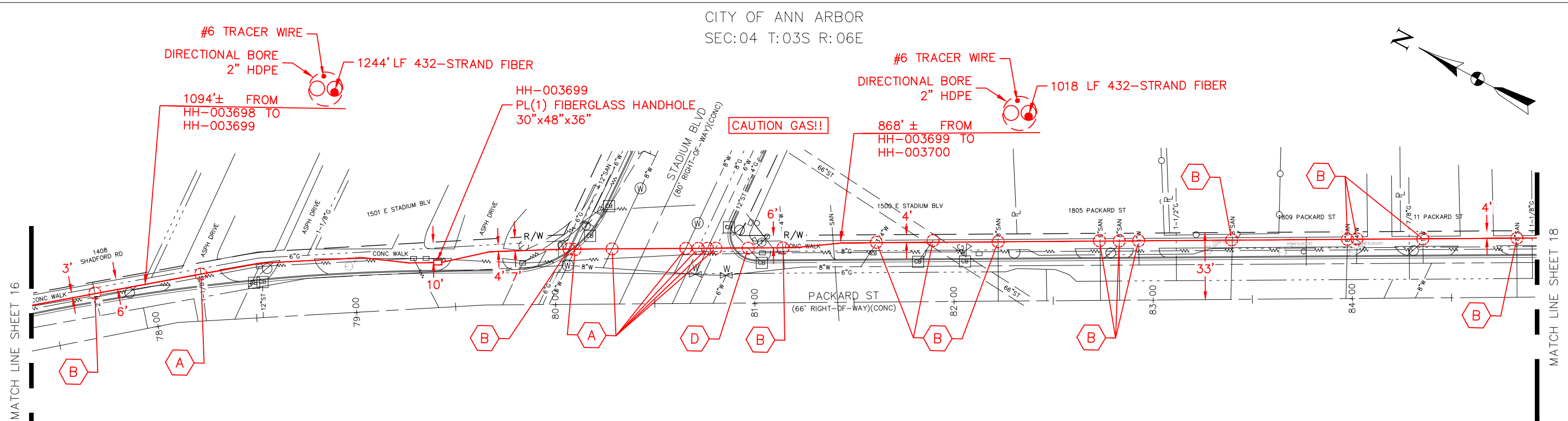
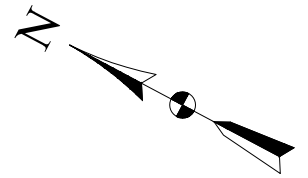

- UTILITY CROSSING/POTHOLE NOTES**
- A** POTHOLE. REMOVE & REPLACE (1) SQFT ASPH ROAD.
  - B** POTHOLE. REMOVE & REPLACE (1) FLAG CONC WALK.
  - C** POTHOLE. REMOVE & REPLACE GREENBELT.
  - D** NO POTHOLE NECESSARY. UTILITY DEPTH TO BE VERIFIED AT NEAREST STRUCTURE.

**811**  
Know what's below.  
Call before you dig.

THE LOCATIONS OF EXISTING UNDERGROUND UTILITIES ARE SHOWN IN AN APPROXIMATE WAY ONLY AND HAVE NOT BEEN INDEPENDENTLY VERIFIED. THE CONTRACTOR SHALL DETERMINE THE EXACT LOCATION OF ALL EXISTING UTILITIES BEFORE COMMENCING WORK, AND AGREES TO BE FULLY RESPONSIBLE FOR ANY AND ALL DAMAGES WHICH MIGHT BE OCCASIONED BY THE CONTRACTOR'S FAILURE TO EXACTLY LOCATE AND PRESERVE ANY AND ALL UNDERGROUND UTILITIES.

<p><b>METRO ENGINEERING SOLUTIONS</b></p> <p>33900 SCHOOLCRAFT RD LIVONIA, MICHIGAN 48150 PHONE: 734.483.1427 FAX: 734.483.3431 www.metroes.net</p>	SOUTH ROUTE - WEST OF U.S. 23		ANN ARBOR SPARK		PERMITS REQUIRED:			SHEET INFORMATION	
	MES JOB#	1043-22	DRAWN	— KMM	<input checked="" type="checkbox"/> CITY OF ANN ARBOR <input type="checkbox"/> CITY OF YPSILANTI <input type="checkbox"/> EGLE <input type="checkbox"/> WASHTENAW COUNTY <input type="checkbox"/> YPSILANTI TOWNSHIP <input type="checkbox"/> RR <input checked="" type="checkbox"/> WASHTENAW COUNTY DRAIN <input type="checkbox"/> PITTSFIELD TOWNSHIP <input checked="" type="checkbox"/> MDOT			TOTAL SHEETS	SHEET NO.
	PLOT SCALE	= 1" = 50'	CHECKED	- JB				42	17
PLAN DATE	= 5/26/2023								

K:\2022\1043-JOB FOLDERS\1043-22-0319_DWG\1043-22-0319_DS.dwg: 9/18/2023 3:03 PM;

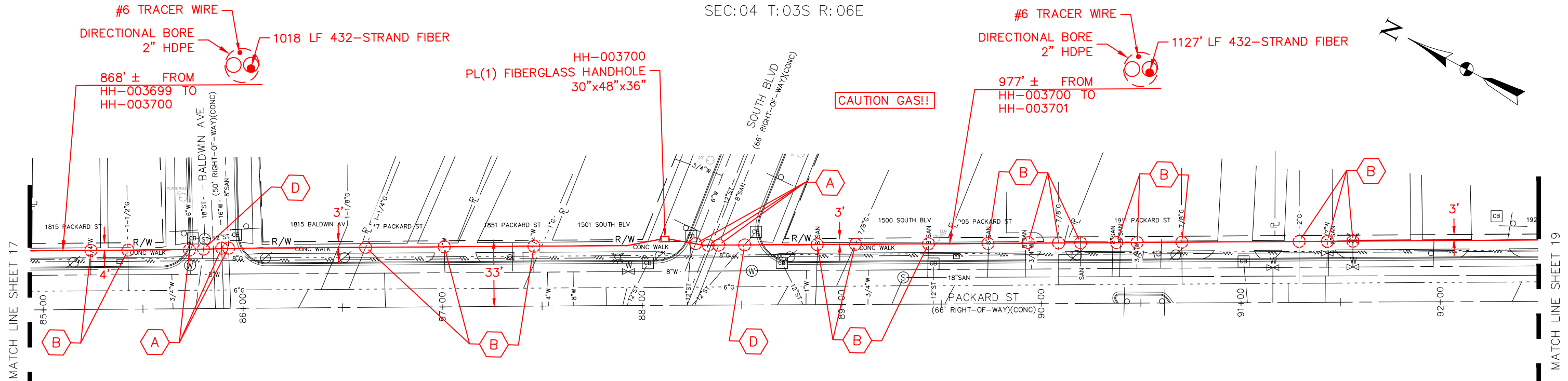
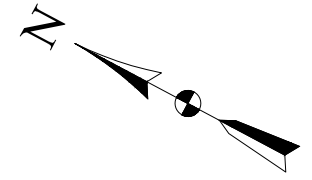

MATCH LINE SHEET 17

MATCH LINE SHEET 19

ROAD CROSSING

ROAD CROSSING

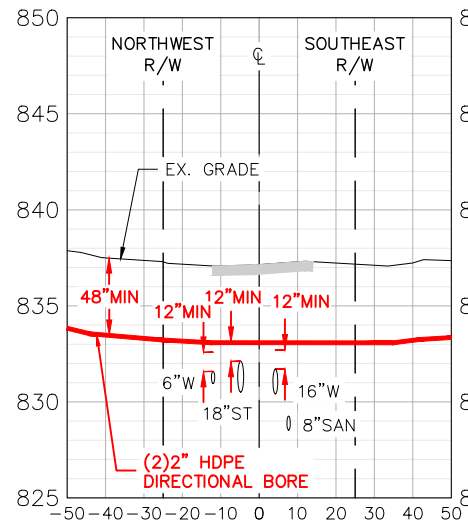

BALDWIN AVE  
LOOKING NORTHEAST  
1"=50' HORIZONTAL  
1"=10' VERTICAL

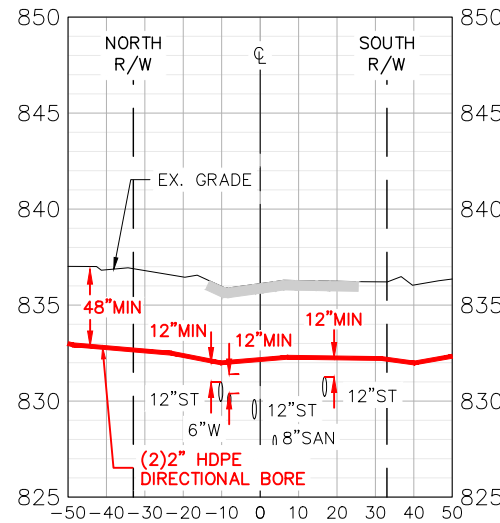

SOUTH BLVD  
LOOKING EAST  
1"=50' HORIZONTAL  
1"=10' VERTICAL

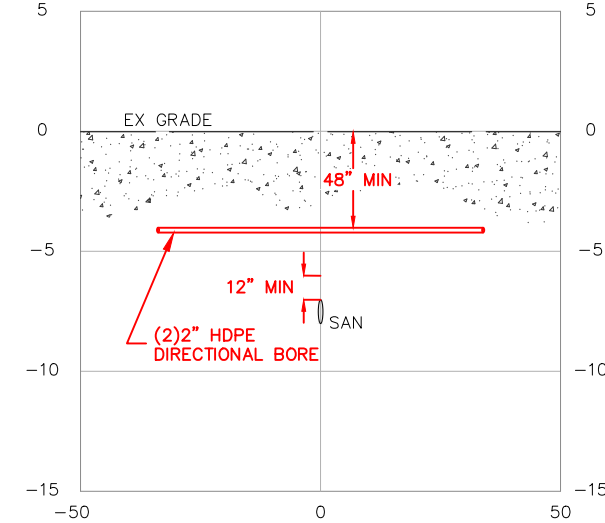

UTILITY CROSSING DETAIL  
PACKARD ST  
STA 88+88, 89+43, 89+73, 89+91,  
90+35, 90+40  
NOT TO SCALE

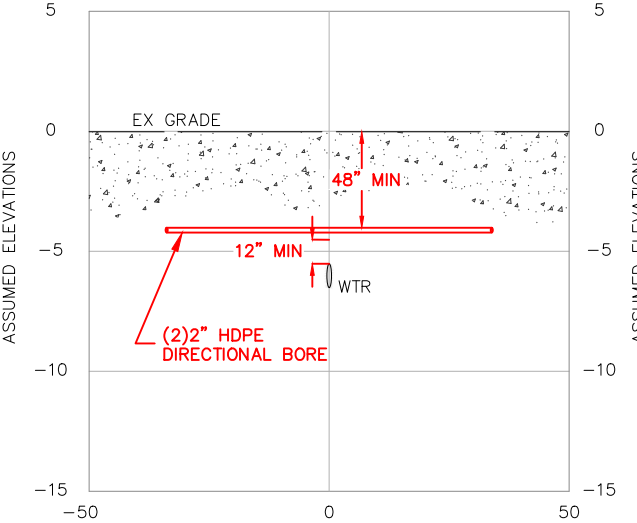

UTILITY CROSSING DETAIL  
PACKARD ST  
STA 85+24, 87+01, 87+45, 89+96,  
90+19, 91+43, 91+56  
NOT TO SCALE

- UTILITY CROSSING/POTHOLE NOTES**
- A** POT HOLE. REMOVE & REPLACE (1) SQFT ASPH ROAD.
  - B** POT HOLE. REMOVE & REPLACE (1) FLAG CONC WALK.
  - C** POT HOLE. REMOVE & REPLACE GREENBELT.
  - D** NO POT HOLE NECESSARY. UTILITY DEPTH TO BE VERIFIED AT NEAREST STRUCTURE.

REVISION		
REV #	DATE	DESCRIPTION
01	7/14/23	REVISED PER CITY OF ANN ARBOR COMMENTS
02	8/24/23	REVISED PER CITY OF ANN ARBOR COMMENTS
03	8/28/23	REVISED PER CITY OF ANN ARBOR COMMENTS
04	9/19/23	REVISED TO AVOID WATER VALVE SHTS 21 & 24



THE LOCATIONS OF EXISTING UNDERGROUND UTILITIES ARE SHOWN IN AN APPROXIMATE WAY ONLY AND HAVE NOT BEEN INDEPENDENTLY VERIFIED. THE CONTRACTOR SHALL DETERMINE THE EXACT LOCATION OF ALL EXISTING UTILITIES BEFORE COMMENCING WORK, AND AGREES TO BE FULLY RESPONSIBLE FOR ANY AND ALL DAMAGES WHICH MIGHT BE OCCASIONED BY THE CONTRACTOR'S FAILURE TO EXACTLY LOCATE AND PRESERVE ANY AND ALL UNDERGROUND UTILITIES.

**METRO ENGINEERING SOLUTIONS**  
33900 SCHOOLCRAFT RD  
LIVONIA, MICHIGAN 48150  
PHONE: 734.483.1427 FAX: 734.483.3431  
www.metroes.net

SOUTH ROUTE - WEST OF U.S. 23	
MES JOB# 1043-22	DRAWN - KMM
PLOT SCALE = 1" = 50'	CHECKED - JB
PLAN DATE = 5/26/2023	

ANN ARBOR SPARK  
CORRIDOR FIBER OPTIC BACKBONE PROJECT  
ANN ARBOR  
WASHTENAW COUNTY, MI

PERMITS REQUIRED:

<input checked="" type="checkbox"/> CITY OF ANN ARBOR	<input type="checkbox"/> CITY OF YPSILANTI	<input type="checkbox"/> EGLE
<input type="checkbox"/> WASHTENAW COUNTY	<input type="checkbox"/> YPSILANTI TOWNSHIP	<input type="checkbox"/> RR
<input checked="" type="checkbox"/> WASHTENAW COUNTY DRAIN	<input type="checkbox"/> PITTSFIELD TOWNSHIP	<input checked="" type="checkbox"/> MDOT

SHEET INFORMATION

TOTAL SHEETS	SHEET NO.
42	18



K:\2022\1043 JOB FOLDERS\1043-22-0319_DWG\1043-22-0319_DS.dwg: 9/18/2023 3:03 PM;

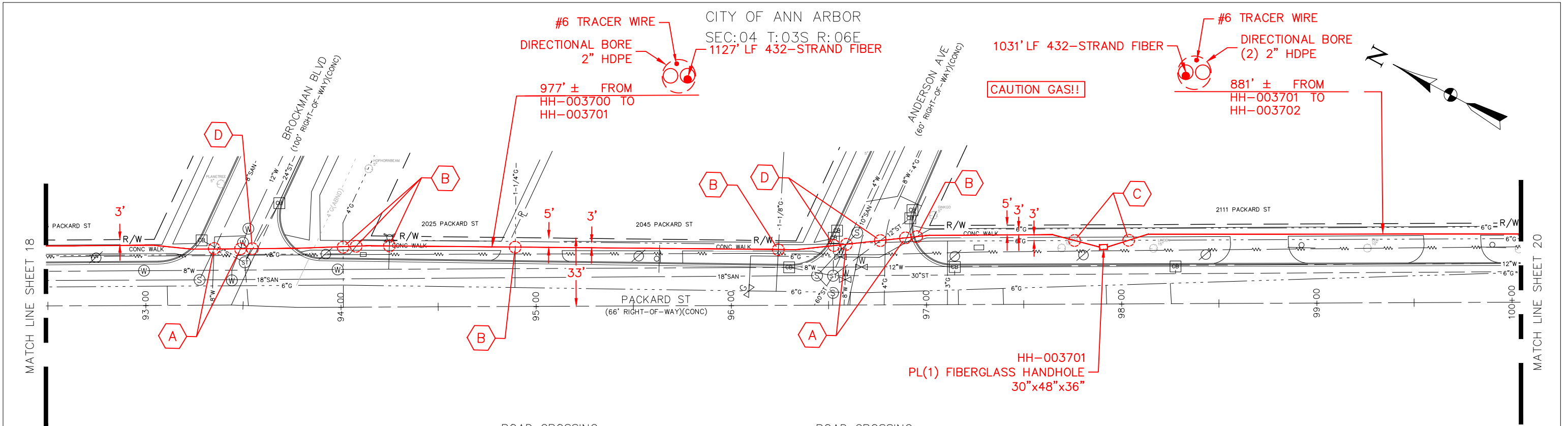

ROAD CROSSING

ROAD CROSSING

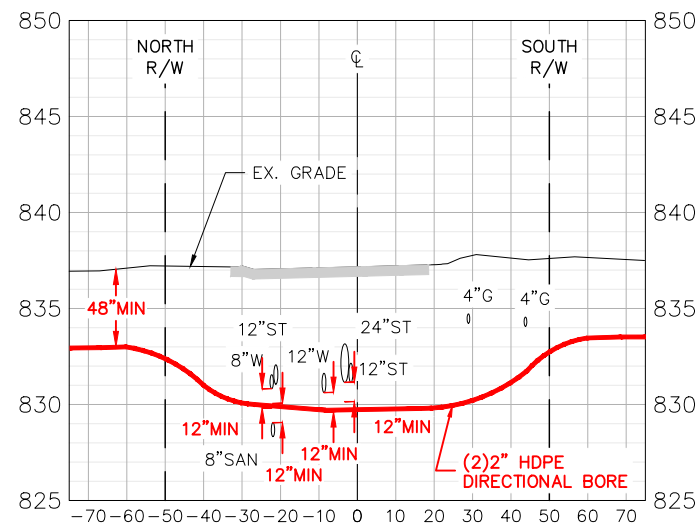

BROCKMAN BLVD  
LOOKING EAST  
1"=50' HORIZONTAL  
1"=10' VERTICAL

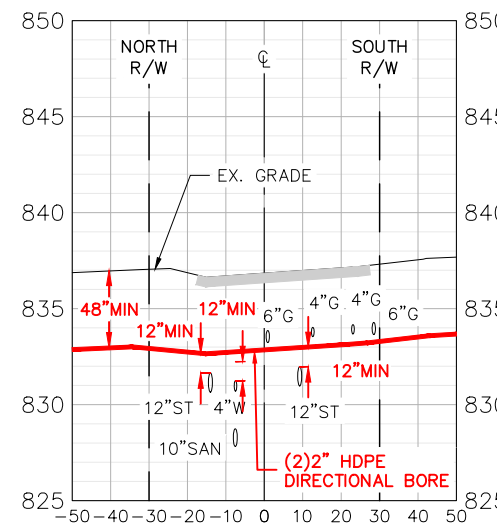

ANDERSON AVE  
LOOKING EAST  
1"=50' HORIZONTAL  
1"=10' VERTICAL

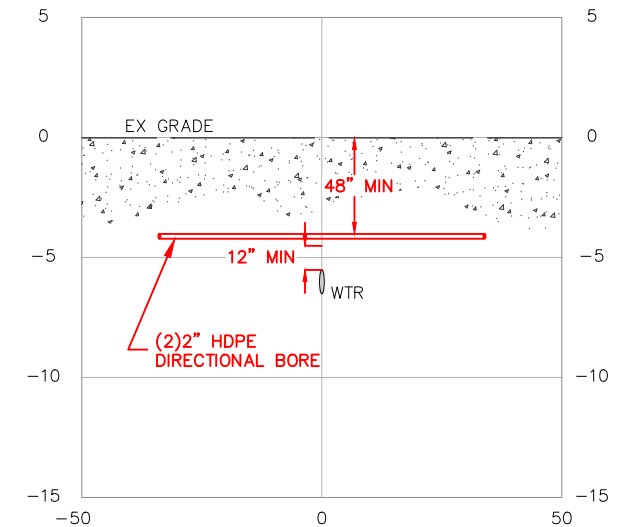

UTILITY CROSSING DETAIL  
PACKARD ST  
STA 94+24

NOT TO SCALE

- UTILITY CROSSING/POTHOLE NOTES**
- A** POTHOLE. REMOVE & REPLACE (1) SQFT ASPH ROAD.
  - B** POTHOLE. REMOVE & REPLACE (1) FLAG CONC WALK.
  - C** POTHOLE. REMOVE & REPLACE GREENBELT.
  - D** NO POTHOLE NECESSARY. UTILITY DEPTH TO BE VERIFIED AT NEAREST STRUCTURE.

REVISION		
REV #	DATE	DESCRIPTION
01	7/14/23	REVISED PER CITY OF ANN ARBOR COMMENTS
02	8/24/23	REVISED PER CITY OF ANN ARBOR COMMENTS
03	8/28/23	REVISED PER CITY OF ANN ARBOR COMMENTS
04	9/19/23	REVISED TO AVOID WATER VALVE SHTS 21 & 24



THE LOCATIONS OF EXISTING UNDERGROUND UTILITIES ARE SHOWN IN AN APPROXIMATE WAY ONLY AND HAVE NOT BEEN INDEPENDENTLY VERIFIED. THE CONTRACTOR SHALL DETERMINE THE EXACT LOCATION OF ALL EXISTING UTILITIES BEFORE COMMENCING WORK, AND AGREES TO BE FULLY RESPONSIBLE FOR ANY AND ALL DAMAGES WHICH MIGHT BE OCCASIONED BY THE CONTRACTOR'S FAILURE TO EXACTLY LOCATE AND PRESERVE ANY AND ALL UNDERGROUND UTILITIES.

**METRO ENGINEERING SOLUTIONS**  
33900 SCHOOLCRAFT RD  
LIVONIA, MICHIGAN 48150  
PHONE: 734.483.1427 FAX: 734.483.3431  
www.metroes.net

SOUTH ROUTE - WEST OF U.S. 23	
MES JOB# 1043-22	DRAWN — KMM
PLOT SCALE = 1" = 50'	CHECKED - JB
PLAN DATE = 5/26/2023	

ANN ARBOR SPARK  
CORRIDOR FIBER OPTIC BACKBONE PROJECT  
ANN ARBOR  
WASHTENAW COUNTY, MI

PERMITS REQUIRED:

<input checked="" type="checkbox"/> CITY OF ANN ARBOR	<input type="checkbox"/> CITY OF YPSILANTI	<input type="checkbox"/> EGLE
<input type="checkbox"/> WASHTENAW COUNTY	<input type="checkbox"/> YPSILANTI TOWNSHIP	<input type="checkbox"/> RR
<input checked="" type="checkbox"/> WASHTENAW COUNTY DRAIN	<input type="checkbox"/> PITTSFIELD TOWNSHIP	<input checked="" type="checkbox"/> MDOT

SHEET INFORMATION

TOTAL SHEETS	SHEET NO.
42	19

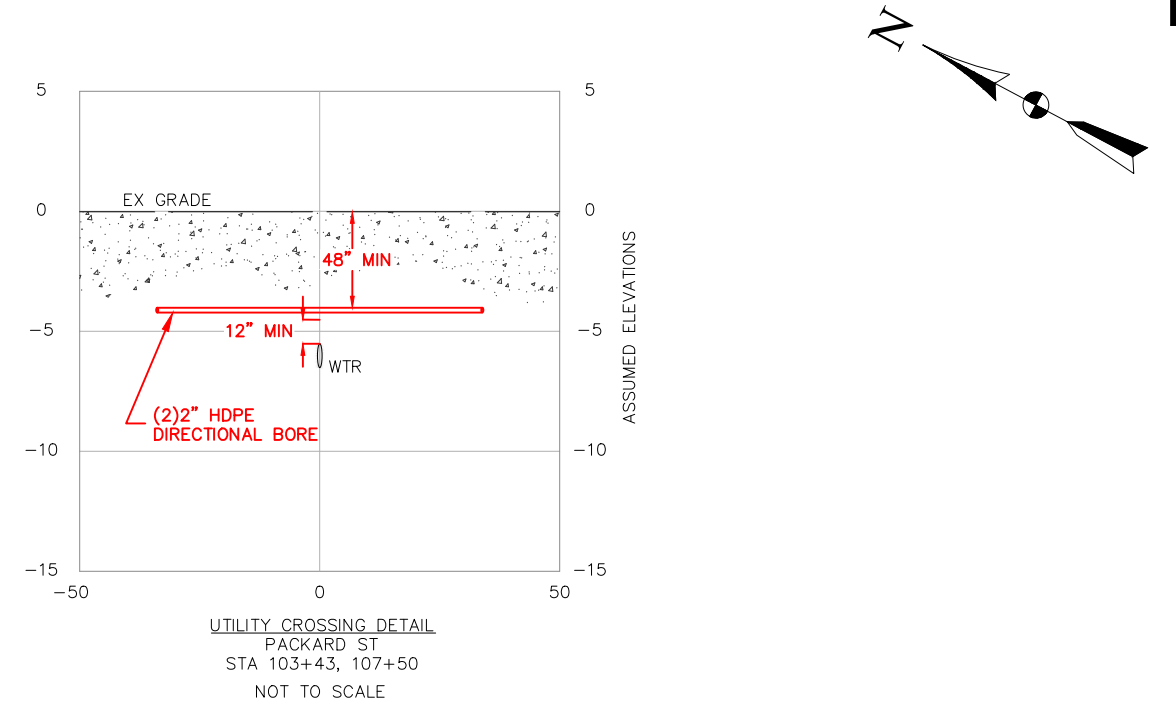
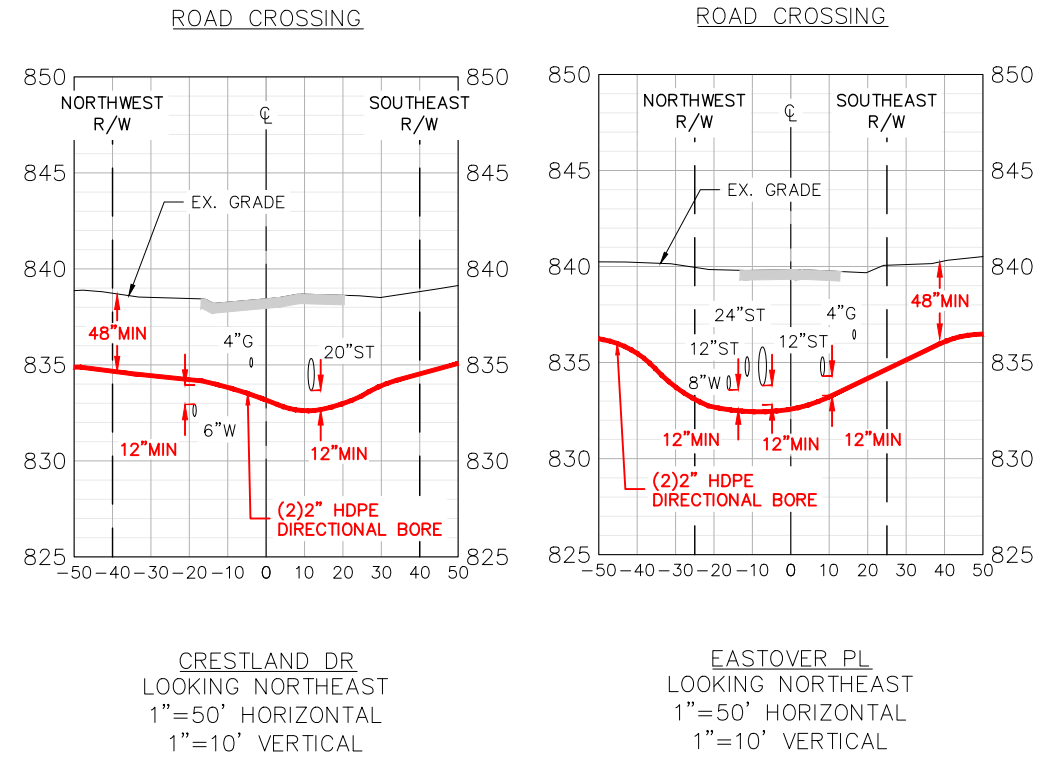
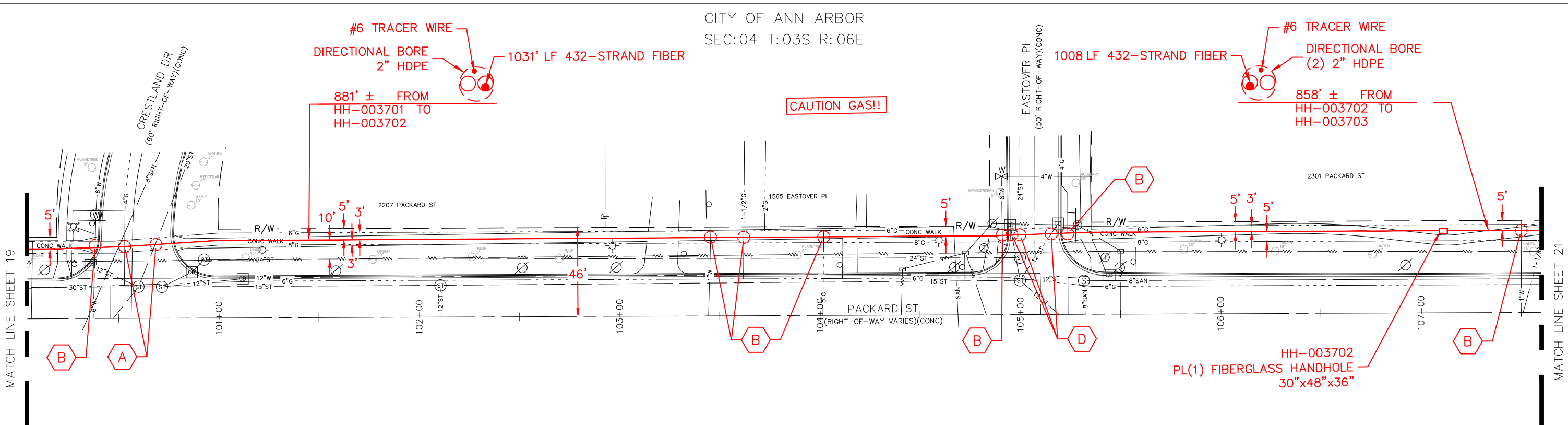

- UTILITY CROSSING/POTHOLE NOTES**
- A** POTHOLE. REMOVE & REPLACE (1) SQFT ASPH ROAD.
  - B** POTHOLE. REMOVE & REPLACE (1) FLAG CONC WALK.
  - C** POTHOLE. REMOVE & REPLACE GREENBELT.
  - D** NO POTHOLE NECESSARY. UTILITY DEPTH TO BE VERIFIED AT NEAREST STRUCTURE.

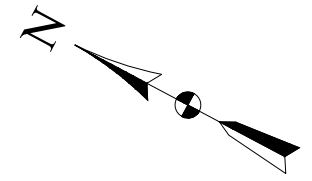

K:\2022\1043 JOB FOLDERS\1043-22-0319\DWG\1043-22-0319_DS.dwg: 9/18/2023 3:03 PM;



THE LOCATIONS OF EXISTING UNDERGROUND UTILITIES ARE SHOWN IN AN APPROXIMATE WAY ONLY AND HAVE NOT BEEN INDEPENDENTLY VERIFIED. THE CONTRACTOR SHALL DETERMINE THE EXACT LOCATION OF ALL EXISTING UTILITIES BEFORE COMMENCING WORK, AND AGREES TO BE FULLY RESPONSIBLE FOR ANY AND ALL DAMAGES WHICH MIGHT BE OCCASIONED BY THE CONTRACTOR'S FAILURE TO EXACTLY LOCATE AND PRESERVE ANY AND ALL UNDERGROUND UTILITIES.

**METRO ENGINEERING SOLUTIONS**  
33900 SCHOOLCRAFT RD  
LIVONIA, MICHIGAN 48150  
PHONE: 734.483.1427 FAX: 734.483.3431  
www.metroes.net

SOUTH ROUTE - WEST OF U.S. 23	
MES JOB# 1043-22	DRAWN — KMM
PLOT SCALE = 1" = 50'	CHECKED - JB
PLAN DATE = 5/26/2023	

ANN ARBOR SPARK  
CORRIDOR FIBER OPTIC BACKBONE PROJECT  
ANN ARBOR  
WASHTENAW COUNTY, MI

PERMITS REQUIRED:

<input checked="" type="checkbox"/> CITY OF ANN ARBOR	<input type="checkbox"/> CITY OF YPSILANTI	<input type="checkbox"/> EGLE
<input type="checkbox"/> WASHTENAW COUNTY	<input type="checkbox"/> YPSILANTI TOWNSHIP	<input type="checkbox"/> RR
<input checked="" type="checkbox"/> WASHTENAW COUNTY DRAIN	<input type="checkbox"/> PITTSFIELD TOWNSHIP	<input checked="" type="checkbox"/> MDOT

SHEET INFORMATION

TOTAL SHEETS	SHEET NO.
42	20

REVISION		
REV #	DATE	DESCRIPTION
01	7/14/23	REVISED PER CITY OF ANN ARBOR COMMENTS
02	8/24/23	REVISED PER CITY OF ANN ARBOR COMMENTS
03	8/28/23	REVISED PER CITY OF ANN ARBOR COMMENTS
04	9/19/23	REVISED TO AVOID WATER VALVE SHTS 21 & 24

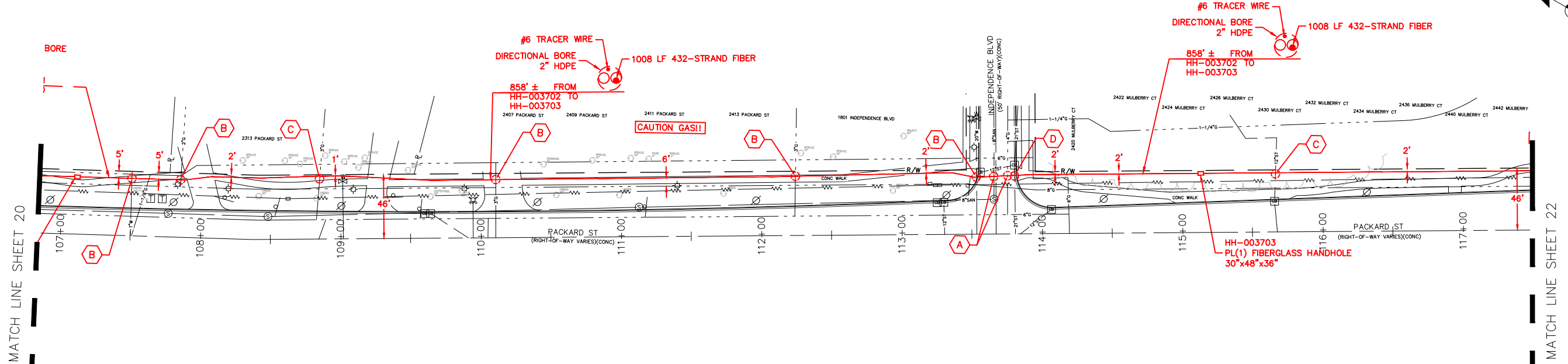
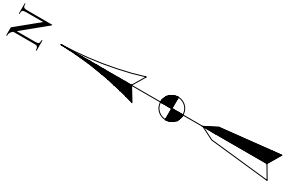

ROAD CROSSING

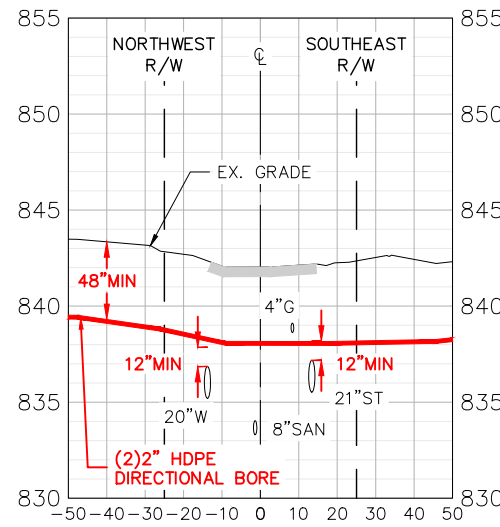

INDEPENDENCE BLVD  
LOOKING NORTHEAST  
1"=50' HORIZONTAL  
1"=10' VERTICAL

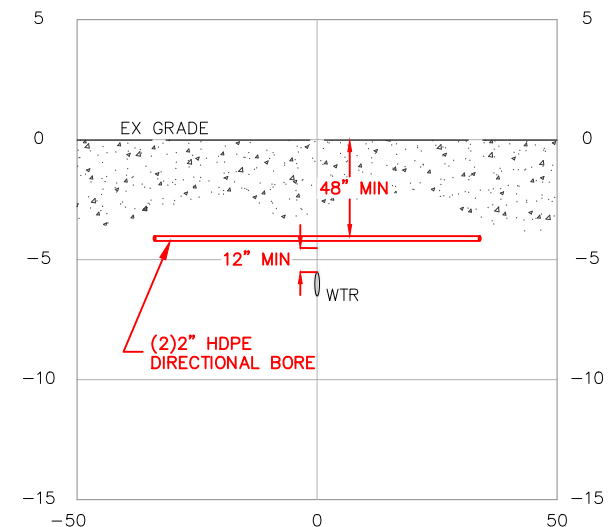

UTILITY CROSSING DETAIL  
PACKARD ST  
STA 109+03  
NOT TO SCALE

- UTILITY CROSSING/POTHOLE NOTES**
- A** POT HOLE. REMOVE & REPLACE (1) SQFT ASPH ROAD.
  - B** POT HOLE. REMOVE & REPLACE (1) FLAG CONC WALK.
  - C** POT HOLE. REMOVE & REPLACE GREENBELT.
  - D** NO POT HOLE NECESSARY. UTILITY DEPTH TO BE VERIFIED AT NEAREST STRUCTURE.



THE LOCATIONS OF EXISTING UNDERGROUND UTILITIES ARE SHOWN IN AN APPROXIMATE WAY ONLY AND HAVE NOT BEEN INDEPENDENTLY VERIFIED. THE CONTRACTOR SHALL DETERMINE THE EXACT LOCATION OF ALL EXISTING UTILITIES BEFORE COMMENCING WORK, AND AGREES TO BE FULLY RESPONSIBLE FOR ANY AND ALL DAMAGES WHICH MIGHT BE OCCASIONED BY THE CONTRACTOR'S FAILURE TO EXACTLY LOCATE AND PRESERVE ANY AND ALL UNDERGROUND UTILITIES.

**METRO ENGINEERING SOLUTIONS**  
33900 SCHOOLCRAFT RD  
LIVONIA, MICHIGAN 48150  
PHONE: 734.483.1427 FAX: 734.483.3431  
www.metroes.net

SOUTH ROUTE - WEST OF U.S. 23	
MES JOB# 1043-22	DRAWN - KMM
PLOT SCALE = 1" = 50'	CHECKED - JB
PLAN DATE = 5/26/2023	

ANN ARBOR SPARK  
CORRIDOR FIBER OPTIC BACKBONE PROJECT  
ANN ARBOR  
WASHTENAW COUNTY, MI

PERMITS REQUIRED:

<input checked="" type="checkbox"/> CITY OF ANN ARBOR	<input type="checkbox"/> CITY OF YPSILANTI	<input type="checkbox"/> EGLE
<input type="checkbox"/> WASHTENAW COUNTY	<input type="checkbox"/> YPSILANTI TOWNSHIP	<input type="checkbox"/> RR
<input checked="" type="checkbox"/> WASHTENAW COUNTY DRAIN	<input type="checkbox"/> PITTSFIELD TOWNSHIP	<input checked="" type="checkbox"/> MDOT

SHEET INFORMATION

TOTAL SHEETS	SHEET NO.
42	21

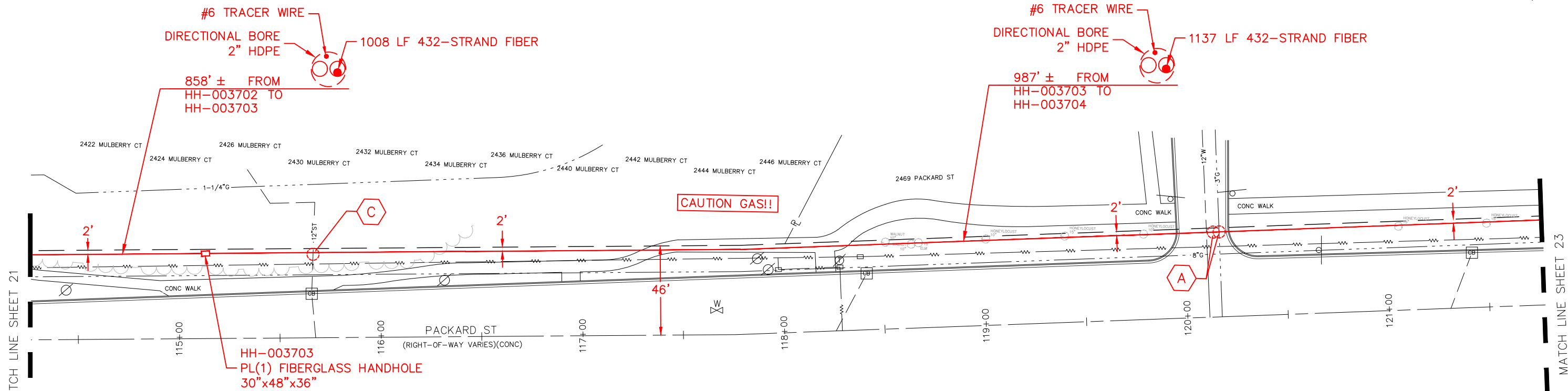
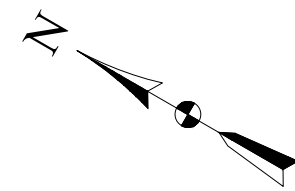

- UTILITY CROSSING/POTHOLE NOTES**
- A** POT HOLE. REMOVE & REPLACE (1) SQFT ASPH ROAD.
  - B** POT HOLE. REMOVE & REPLACE (1) FLAG CONC WALK.
  - C** POT HOLE. REMOVE & REPLACE GREENBELT.
  - D** NO POT HOLE NECESSARY. UTILITY DEPTH TO BE VERIFIED AT NEAREST STRUCTURE.

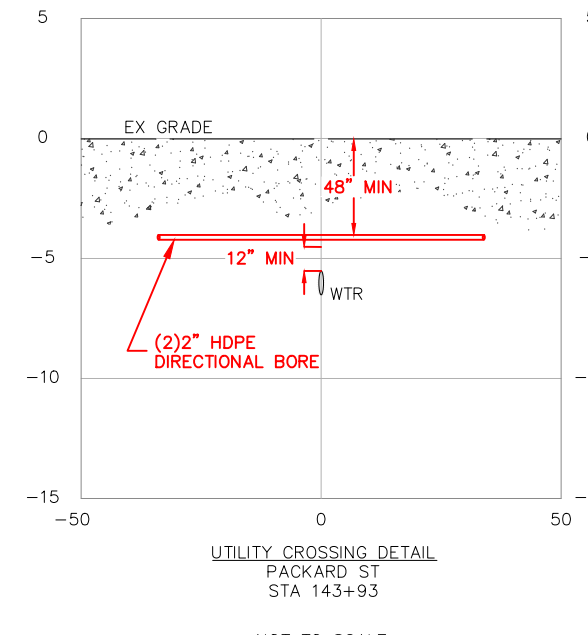
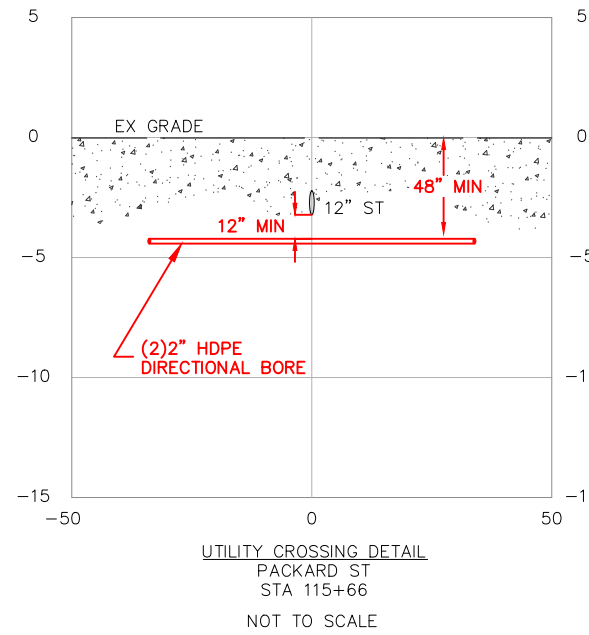

REVISION		
REV #	DATE	DESCRIPTION
01	7/14/23	REVISED PER CITY OF ANN ARBOR COMMENTS
02	8/24/23	REVISED PER CITY OF ANN ARBOR COMMENTS
03	8/28/23	REVISED PER CITY OF ANN ARBOR COMMENTS
04	9/19/23	REVISED TO AVOID WATER VALVE SHTS 21 & 24



THE LOCATIONS OF EXISTING UNDERGROUND UTILITIES ARE SHOWN IN AN APPROXIMATE WAY ONLY AND HAVE NOT BEEN INDEPENDENTLY VERIFIED. THE CONTRACTOR SHALL DETERMINE THE EXACT LOCATION OF ALL EXISTING UTILITIES BEFORE COMMENCING WORK, AND AGREES TO BE FULLY RESPONSIBLE FOR ANY AND ALL DAMAGES WHICH MIGHT BE OCCASIONED BY THE CONTRACTOR'S FAILURE TO EXACTLY LOCATE AND PRESERVE ANY AND ALL UNDERGROUND UTILITIES.

**METRO ENGINEERING SOLUTIONS**  
33900 SCHOOLCRAFT RD  
LIVONIA, MICHIGAN 48150  
PHONE: 734.483.1427 FAX: 734.483.3431  
www.metroes.net

SOUTH ROUTE - WEST OF U.S. 23	
MES JOB# 1043-22	DRAWN - KMM
PLOT SCALE = 1" = 50'	CHECKED - JB
PLAN DATE = 5/26/2023	

ANN ARBOR SPARK  
CORRIDOR FIBER OPTIC BACKBONE PROJECT  
ANN ARBOR  
WASHTENAW COUNTY, MI

PERMITS REQUIRED:

<input checked="" type="checkbox"/> CITY OF ANN ARBOR	<input type="checkbox"/> CITY OF YPSILANTI	<input type="checkbox"/> EGLE
<input type="checkbox"/> WASHTENAW COUNTY	<input type="checkbox"/> YPSILANTI TOWNSHIP	<input type="checkbox"/> RR
<input checked="" type="checkbox"/> WASHTENAW COUNTY DRAIN	<input type="checkbox"/> PITTSFIELD TOWNSHIP	<input checked="" type="checkbox"/> MDOT

SHEET INFORMATION

TOTAL SHEETS	SHEET NO.
42	22

K:\2022\1043 JOB FOLDERS\1043-22-0319\DWG\1043-22-0319_DS.dwg: 9/18/2023 3:03 PM;



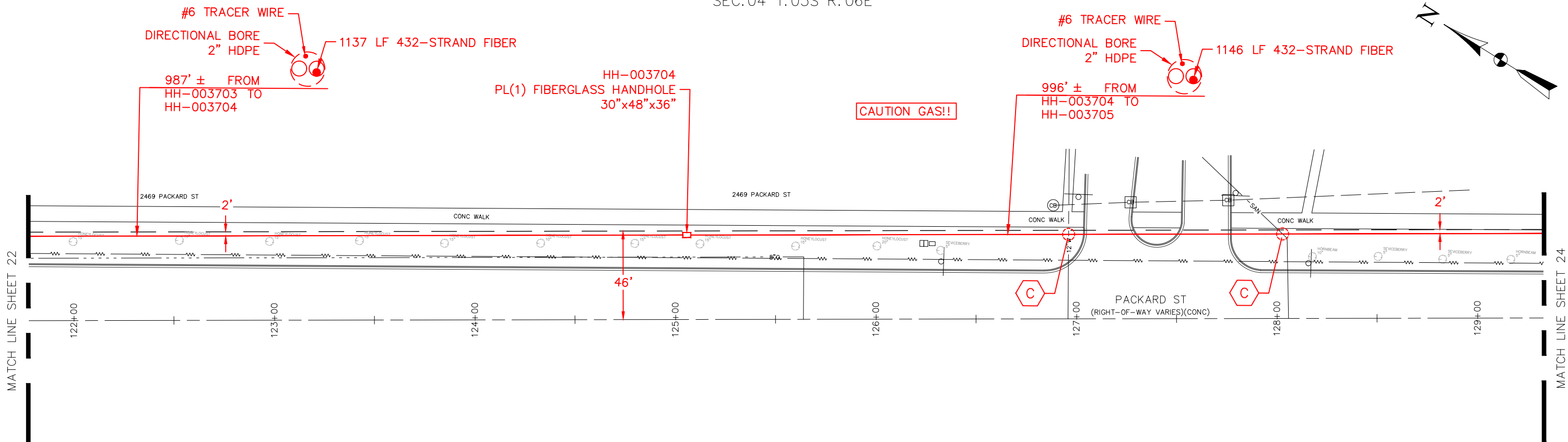
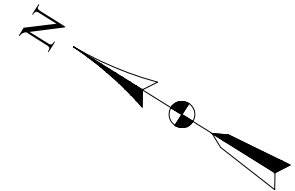

- UTILITY CROSSING/POTHOLE NOTES**
- A** POTHOLE. REMOVE & REPLACE (1) SQFT ASPH ROAD.
  - B** POTHOLE. REMOVE & REPLACE (1) FLAG CONC WALK.
  - C** POTHOLE. REMOVE & REPLACE GREENBELT.
  - D** NO POTHOLE NECESSARY. UTILITY DEPTH TO BE VERIFIED AT NEAREST STRUCTURE.

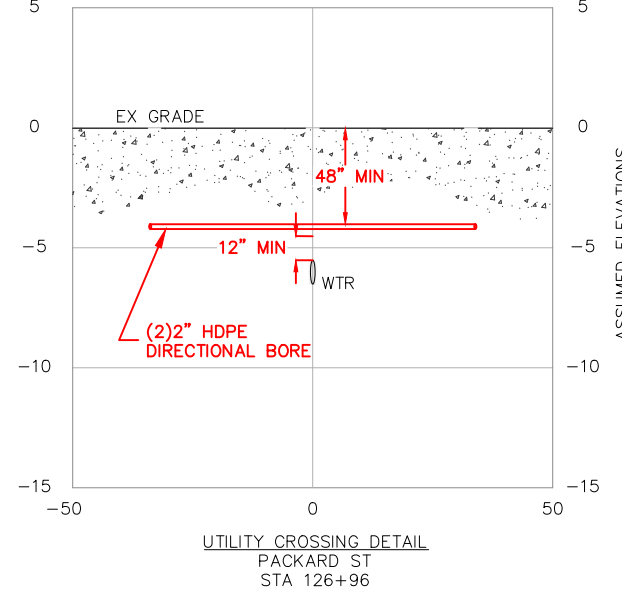
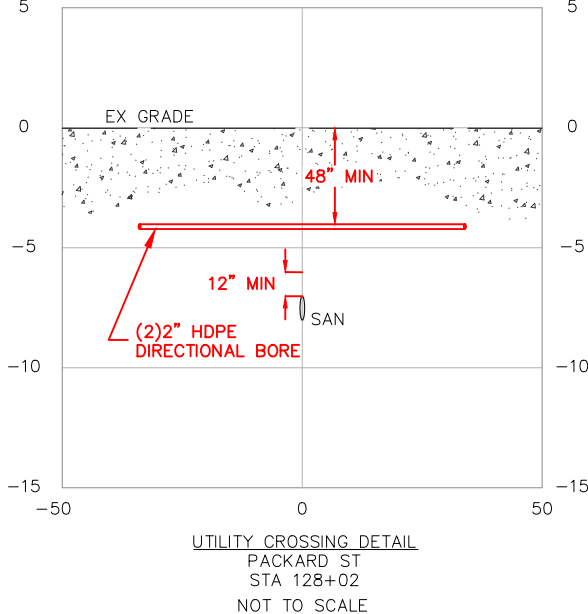

REVISION		
REV #	DATE	DESCRIPTION
01	7/14/23	REVISED PER CITY OF ANN ARBOR COMMENTS
02	8/24/23	REVISED PER CITY OF ANN ARBOR COMMENTS
03	8/28/23	REVISED PER CITY OF ANN ARBOR COMMENTS
04	9/19/23	REVISED TO AVOID WATER VALVE SHTS 21 & 24



THE LOCATIONS OF EXISTING UNDERGROUND UTILITIES ARE SHOWN IN AN APPROXIMATE WAY ONLY AND HAVE NOT BEEN INDEPENDENTLY VERIFIED. THE CONTRACTOR SHALL DETERMINE THE EXACT LOCATION OF ALL EXISTING UTILITIES BEFORE COMMENCING WORK, AND AGREES TO BE FULLY RESPONSIBLE FOR ANY AND ALL DAMAGES WHICH MIGHT BE OCCASIONED BY THE CONTRACTOR'S FAILURE TO EXACTLY LOCATE AND PRESERVE ANY AND ALL UNDERGROUND UTILITIES.

**METRO ENGINEERING SOLUTIONS**  
33900 SCHOOLCRAFT RD  
LIVONIA, MICHIGAN 48150  
PHONE: 734.483.1427 FAX: 734.483.3431  
www.metroes.net

SOUTH ROUTE - WEST OF U.S. 23	
MES JOB# 1043-22	DRAWN - KMM
PLOT SCALE = 1" = 50'	CHECKED - JB
PLAN DATE = 5/26/2023	

ANN ARBOR SPARK  
CORRIDOR FIBER OPTIC BACKBONE PROJECT  
ANN ARBOR  
WASHTENAW COUNTY, MI

PERMITS REQUIRED:

<input checked="" type="checkbox"/> CITY OF ANN ARBOR	<input type="checkbox"/> CITY OF YPSILANTI	<input type="checkbox"/> EGLE
<input type="checkbox"/> WASHTENAW COUNTY	<input type="checkbox"/> YPSILANTI TOWNSHIP	<input type="checkbox"/> RR
<input checked="" type="checkbox"/> WASHTENAW COUNTY DRAIN	<input type="checkbox"/> PITTSFIELD TOWNSHIP	<input checked="" type="checkbox"/> MDOT

SHEET INFORMATION

TOTAL SHEETS	SHEET NO.
42	23

K:\2022\1043 JOB FOLDERS\1043-22-0319\DWG\1043-22-0319_DS.dwg: 9/18/2023 3:03 PM;

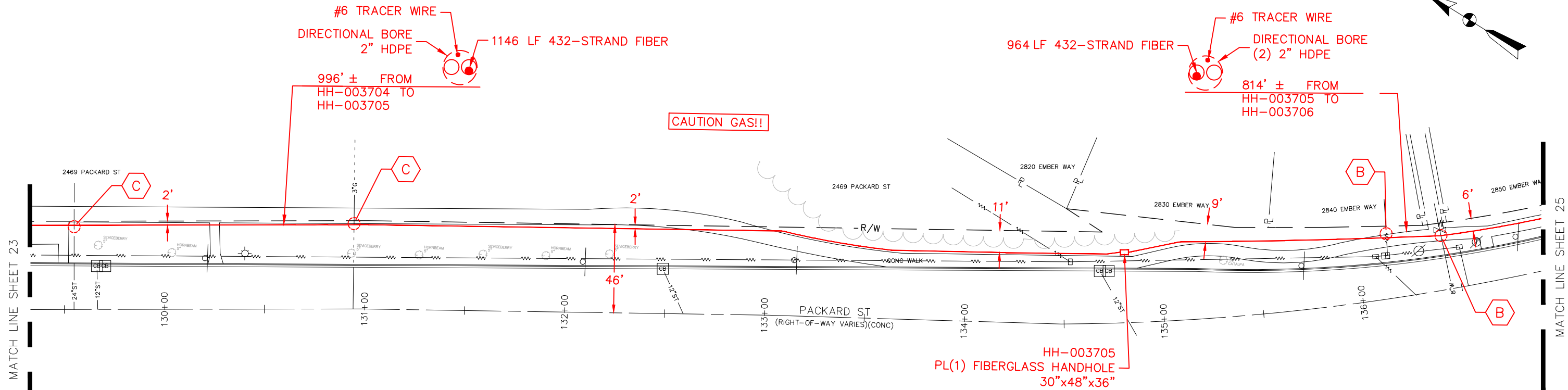
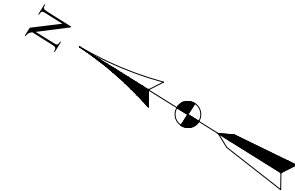

CAUTION GAS!!

HH-003705  
PL(1) FIBERGLASS HANDHOLE  
30"x48"x36"

- UTILITY CROSSING/POTHOLE NOTES**
- A** POT HOLE. REMOVE & REPLACE (1) SQFT ASPH ROAD.
  - B** POT HOLE. REMOVE & REPLACE (1) FLAG CONC WALK.
  - C** POT HOLE. REMOVE & REPLACE GREENBELT.
  - D** NO POT HOLE NECESSARY. UTILITY DEPTH TO BE VERIFIED AT NEAREST STRUCTURE.

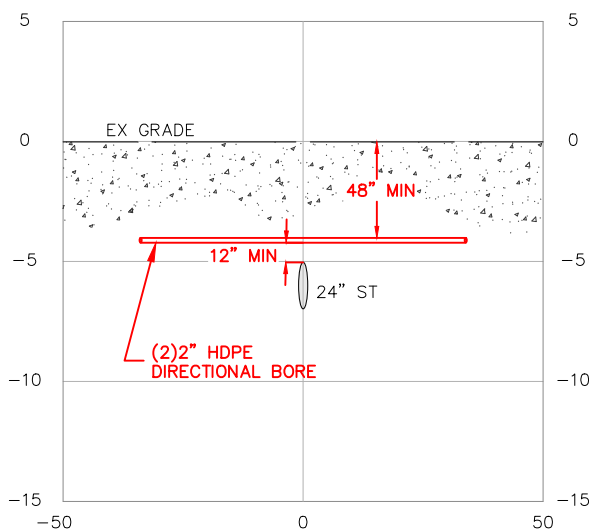

UTILITY CROSSING DETAIL  
PACKARD ST  
STA 129+54  
NOT TO SCALE

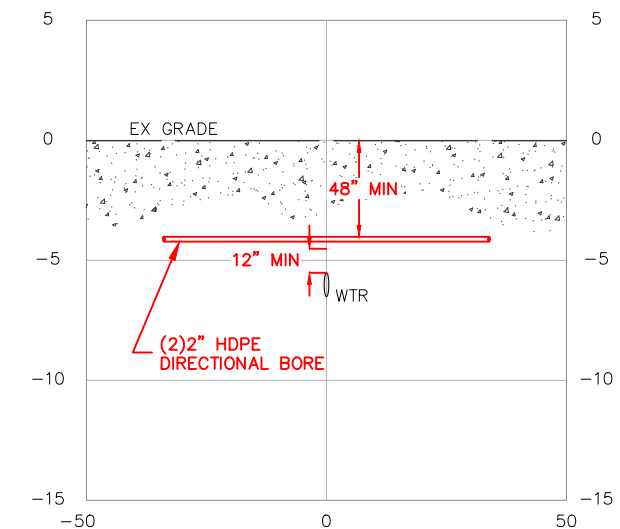

UTILITY CROSSING DETAIL  
PACKARD ST  
STA 136+45  
NOT TO SCALE

REVISION		
REV #	DATE	DESCRIPTION
01	7/14/23	REVISED PER CITY OF ANN ARBOR COMMENTS
02	8/24/23	REVISED PER CITY OF ANN ARBOR COMMENTS
03	8/28/23	REVISED PER CITY OF ANN ARBOR COMMENTS
04	9/19/23	REVISED TO AVOID WATER VALVE SHTS 21 & 24



THE LOCATIONS OF EXISTING UNDERGROUND UTILITIES ARE SHOWN IN AN APPROXIMATE WAY ONLY AND HAVE NOT BEEN INDEPENDENTLY VERIFIED. THE CONTRACTOR SHALL DETERMINE THE EXACT LOCATION OF ALL EXISTING UTILITIES BEFORE COMMENCING WORK, AND AGREES TO BE FULLY RESPONSIBLE FOR ANY AND ALL DAMAGES WHICH MIGHT BE OCCASIONED BY THE CONTRACTOR'S FAILURE TO EXACTLY LOCATE AND PRESERVE ANY AND ALL UNDERGROUND UTILITIES.

**METRO ENGINEERING SOLUTIONS**  
33900 SCHOOLCRAFT RD  
LIVONIA, MICHIGAN 48150  
PHONE: 734.483.1427 FAX: 734.483.3431  
www.metroes.net

SOUTH ROUTE - WEST OF U.S. 23	
MES JOB# 1043-22	DRAWN - KMM
PLOT SCALE = 1" = 50'	CHECKED - JB
PLAN DATE = 5/26/2023	

ANN ARBOR SPARK  
CORRIDOR FIBER OPTIC BACKBONE PROJECT  
ANN ARBOR  
WASHTENAW COUNTY, MI

PERMITS REQUIRED:

<input checked="" type="checkbox"/> CITY OF ANN ARBOR	<input type="checkbox"/> CITY OF YPSILANTI	<input type="checkbox"/> EGLE
<input type="checkbox"/> WASHTENAW COUNTY	<input type="checkbox"/> YPSILANTI TOWNSHIP	<input type="checkbox"/> RR
<input checked="" type="checkbox"/> WASHTENAW COUNTY DRAIN	<input type="checkbox"/> PITTSFIELD TOWNSHIP	<input checked="" type="checkbox"/> MDOT

SHEET INFORMATION

TOTAL SHEETS	SHEET NO.
42	24

K:\2022\1043 JOB FOLDERS\1043-22-0319\DWG\1043-22-0319_DS.dwg: 9/18/2023 3:03 PM;

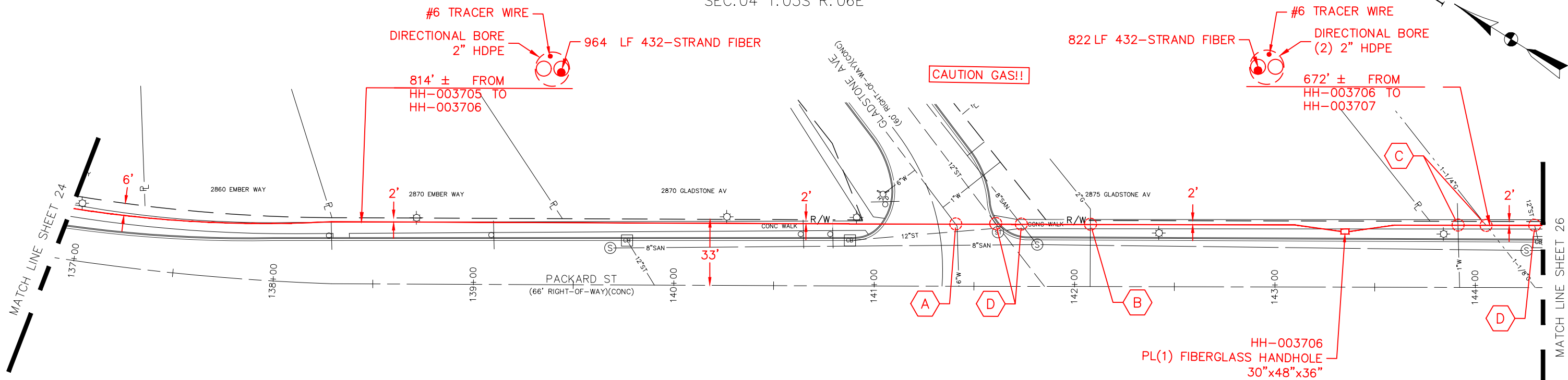
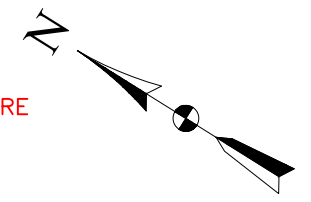

ROAD CROSSING

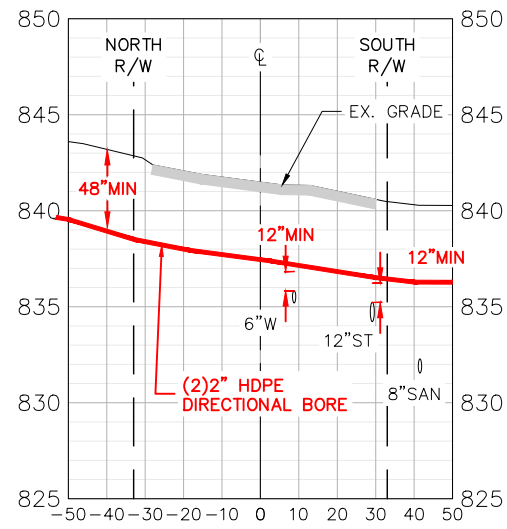

GLADSTONE AVE  
LOOKING NORTH  
1"=50' HORIZONTAL  
1"=10' VERTICAL

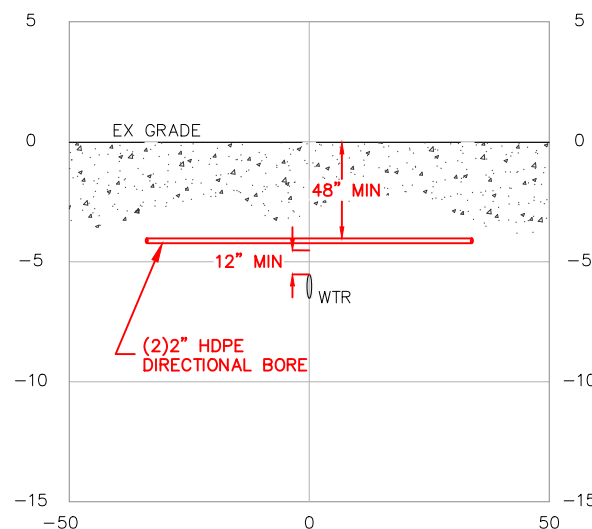

UTILITY CROSSING DETAIL  
PACKARD ST  
STA 143+93  
NOT TO SCALE

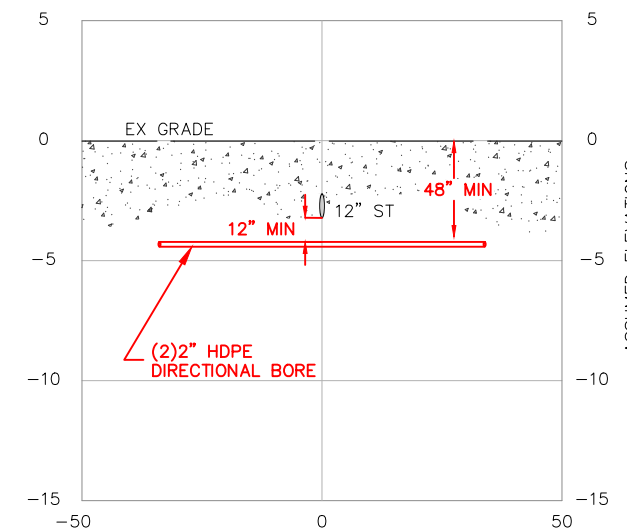

UTILITY CROSSING DETAIL  
PACKARD ST  
STA 144+33  
NOT TO SCALE

- UTILITY CROSSING/POTHOLE NOTES**
- A** POTHOLE. REMOVE & REPLACE (1) SQFT ASPH ROAD.
  - B** POTHOLE. REMOVE & REPLACE (1) FLAG CONC WALK.
  - C** POTHOLE. REMOVE & REPLACE GREENBELT.
  - D** NO POTHOLE NECESSARY. UTILITY DEPTH TO BE VERIFIED AT NEAREST STRUCTURE.

REVISION		
REV #	DATE	DESCRIPTION
01	7/14/23	REVISED PER CITY OF ANN ARBOR COMMENTS
02	8/24/23	REVISED PER CITY OF ANN ARBOR COMMENTS
03	8/28/23	REVISED PER CITY OF ANN ARBOR COMMENTS
04	9/19/23	REVISED TO AVOID WATER VALVE SHTS 21 & 24



THE LOCATIONS OF EXISTING UNDERGROUND UTILITIES ARE SHOWN IN AN APPROXIMATE WAY ONLY AND HAVE NOT BEEN INDEPENDENTLY VERIFIED. THE CONTRACTOR SHALL DETERMINE THE EXACT LOCATION OF ALL EXISTING UTILITIES BEFORE COMMENCING WORK, AND AGREES TO BE FULLY RESPONSIBLE FOR ANY AND ALL DAMAGES WHICH MIGHT BE OCCASIONED BY THE CONTRACTOR'S FAILURE TO EXACTLY LOCATE AND PRESERVE ANY AND ALL UNDERGROUND UTILITIES.

**METRO ENGINEERING SOLUTIONS**  
33900 SCHOOLCRAFT RD  
LIVONIA, MICHIGAN 48150  
PHONE: 734.483.1427 FAX: 734.483.3431  
www.metroes.net

SOUTH ROUTE - WEST OF U.S. 23	
MES JOB# 1043-22	DRAWN - KMM
PLOT SCALE = 1" = 50'	CHECKED - JB
PLAN DATE = 5/26/2023	

ANN ARBOR SPARK  
CORRIDOR FIBER OPTIC BACKBONE PROJECT  
ANN ARBOR  
WASHTENAW COUNTY, MI

PERMITS REQUIRED:		
<input checked="" type="checkbox"/> CITY OF ANN ARBOR	<input type="checkbox"/> CITY OF YPSILANTI	<input type="checkbox"/> EGLE
<input type="checkbox"/> WASHTENAW COUNTY	<input type="checkbox"/> YPSILANTI TOWNSHIP	<input type="checkbox"/> RR
<input checked="" type="checkbox"/> WASHTENAW COUNTY DRAIN	<input type="checkbox"/> PITTSFIELD TOWNSHIP	<input checked="" type="checkbox"/> MDOT

SHEET INFORMATION	
TOTAL SHEETS	SHEET NO.
42	25

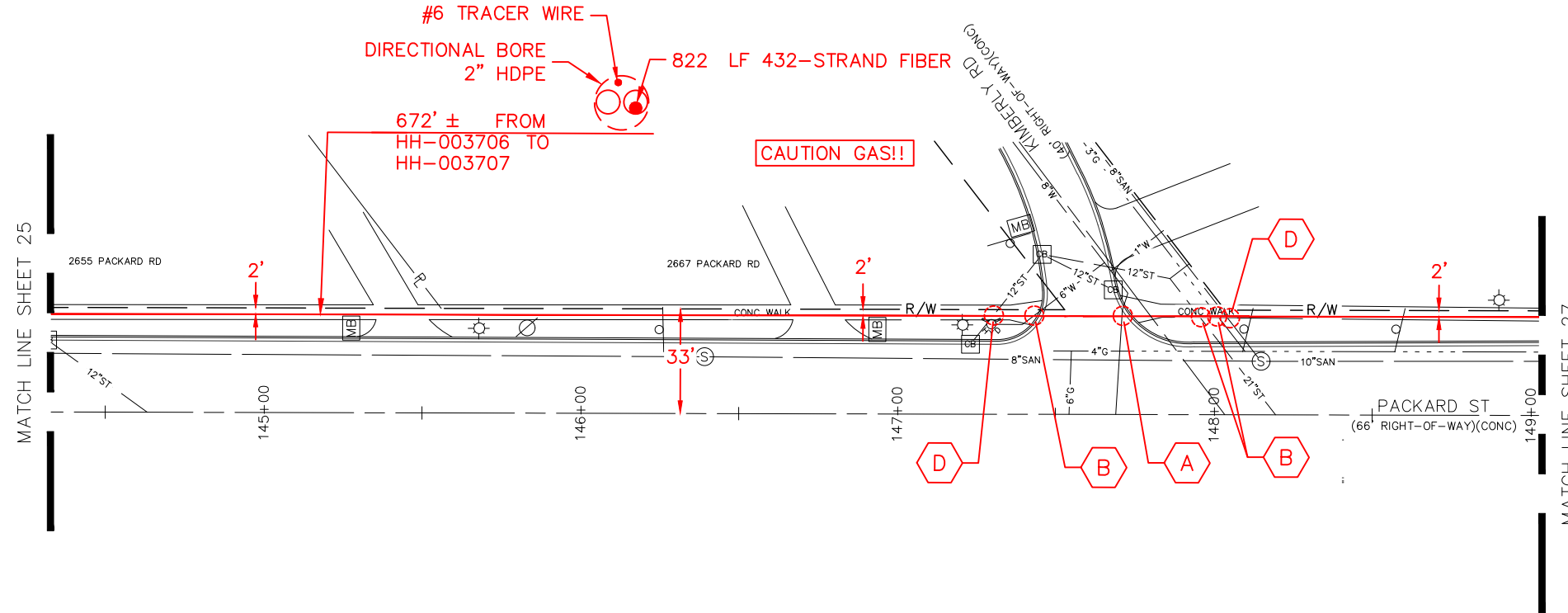
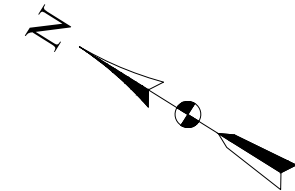

ROAD CROSSING

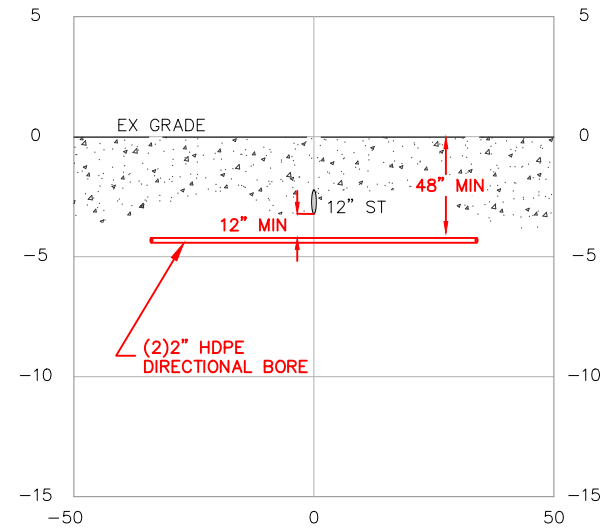
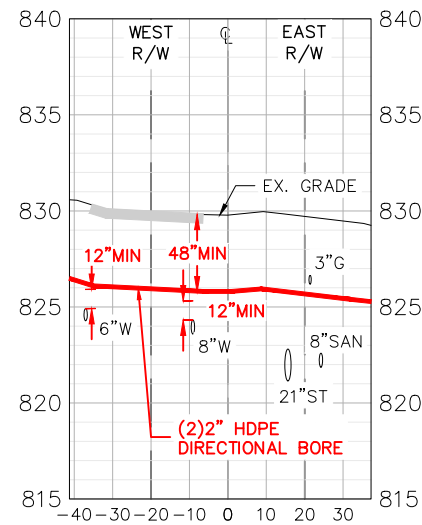

UTILITY CROSSING DETAIL  
PACKARD ST  
STA 147+30  
NOT TO SCALE

**UTILITY CROSSING/POTHOLE NOTES**

- A** POT HOLE. REMOVE & REPLACE (1) SQFT ASPH ROAD.
- B** POT HOLE. REMOVE & REPLACE (1) FLAG CONC WALK.
- C** POT HOLE. REMOVE & REPLACE GREENBELT.
- D** NO POT HOLE NECESSARY. UTILITY DEPTH TO BE VERIFIED AT NEAREST STRUCTURE.

KIMBERLY RD  
LOOKING NORTH  
1"=50' HORIZONTAL  
1"=10' VERTICAL

REVISION		
REV #	DATE	DESCRIPTION
01	7/14/23	REVISED PER CITY OF ANN ARBOR COMMENTS
02	8/24/23	REVISED PER CITY OF ANN ARBOR COMMENTS
03	8/28/23	REVISED PER CITY OF ANN ARBOR COMMENTS
04	9/19/23	REVISED TO AVOID WATER VALVE SHTS 21 & 24



THE LOCATIONS OF EXISTING UNDERGROUND UTILITIES ARE SHOWN IN AN APPROXIMATE WAY ONLY AND HAVE NOT BEEN INDEPENDENTLY VERIFIED. THE CONTRACTOR SHALL DETERMINE THE EXACT LOCATION OF ALL EXISTING UTILITIES BEFORE COMMENCING WORK, AND AGREES TO BE FULLY RESPONSIBLE FOR ANY AND ALL DAMAGES WHICH MIGHT BE OCCASIONED BY THE CONTRACTOR'S FAILURE TO EXACTLY LOCATE AND PRESERVE ANY AND ALL UNDERGROUND UTILITIES.

**METRO ENGINEERING SOLUTIONS**  
33900 SCHOOLCRAFT RD  
LIVONIA, MICHIGAN 48150  
PHONE: 734.483.1427 FAX: 734.483.3431  
www.metroes.net

SOUTH ROUTE - WEST OF U.S. 23	
MES JOB# 1043-22	DRAWN - KMM
PLOT SCALE = 1" = 50'	CHECKED - JB
PLAN DATE = 5/26/2023	

ANN ARBOR SPARK  
CORRIDOR FIBER OPTIC BACKBONE PROJECT  
ANN ARBOR  
WASHTENAW COUNTY, MI

PERMITS REQUIRED:

<input checked="" type="checkbox"/> CITY OF ANN ARBOR	<input type="checkbox"/> CITY OF YPSILANTI	<input type="checkbox"/> EGLE
<input type="checkbox"/> WASHTENAW COUNTY	<input type="checkbox"/> YPSILANTI TOWNSHIP	<input type="checkbox"/> RR
<input checked="" type="checkbox"/> WASHTENAW COUNTY DRAIN	<input type="checkbox"/> PITTSFIELD TOWNSHIP	<input checked="" type="checkbox"/> MDOT

SHEET INFORMATION

TOTAL SHEETS	SHEET NO.
42	26

CITY OF ANN ARBOR  
SEC:10 T:03S R:06E

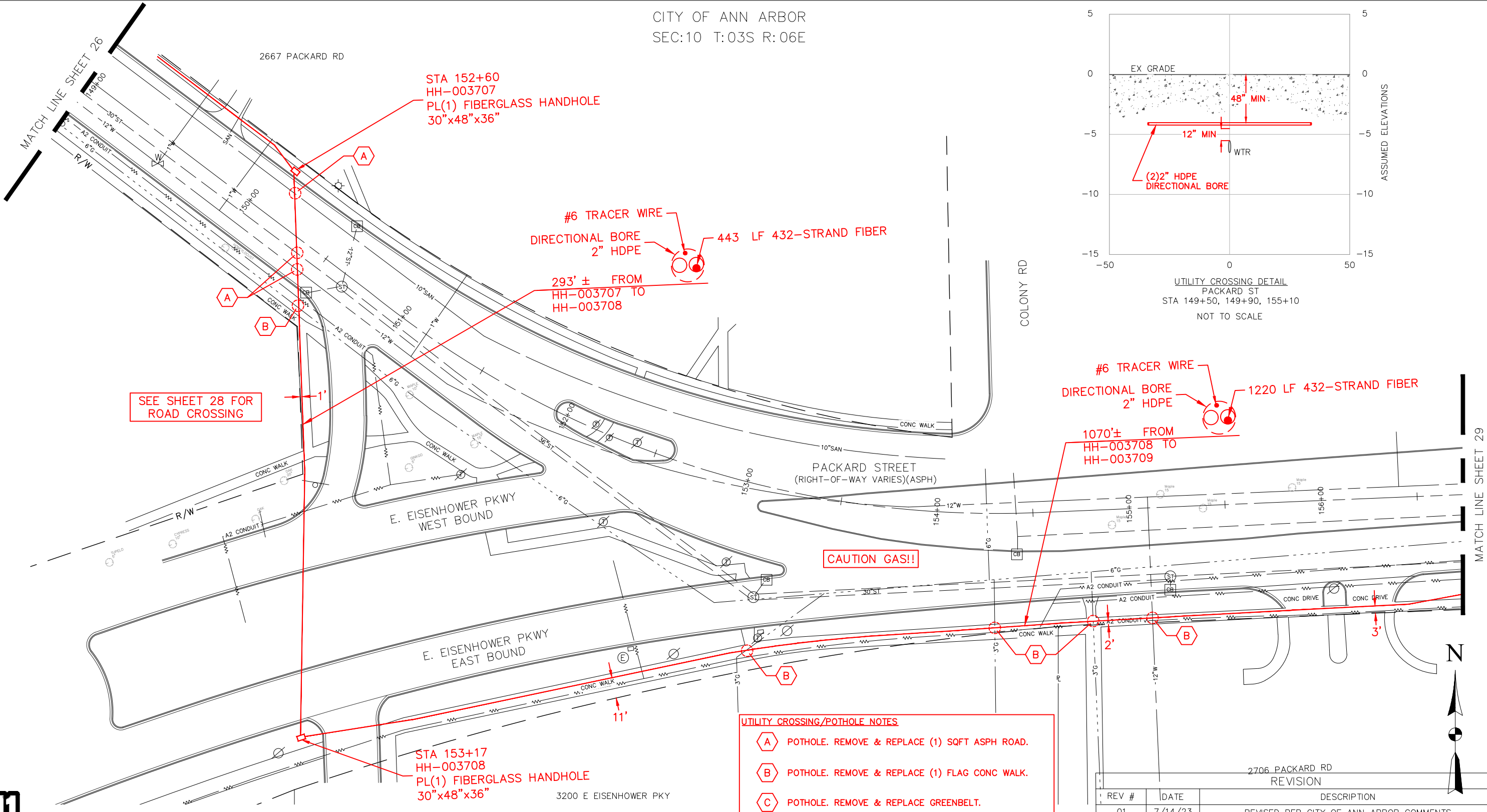
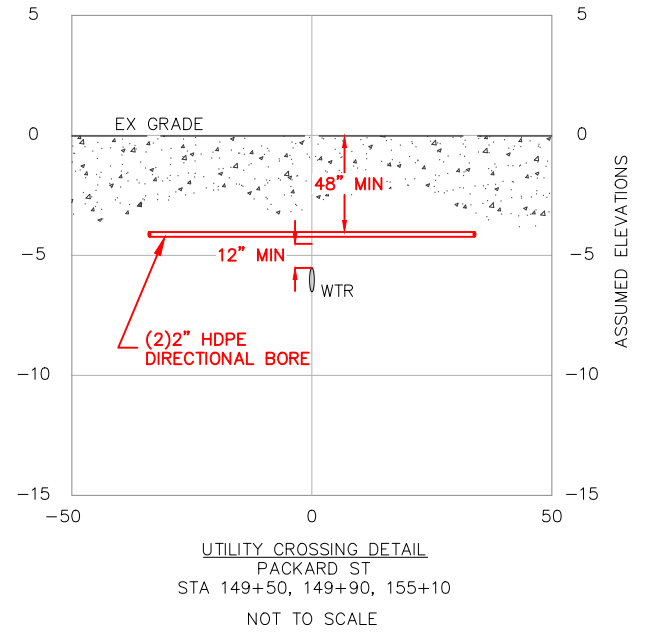

- UTILITY CROSSING/POTHOLE NOTES**
- A** POTHOLE. REMOVE & REPLACE (1) SQFT ASPH ROAD.
  - B** POTHOLE. REMOVE & REPLACE (1) FLAG CONC WALK.
  - C** POTHOLE. REMOVE & REPLACE GREENBELT.
  - D** NO POTHOLE NECESSARY. UTILITY DEPTH TO BE VERIFIED AT NEAREST STRUCTURE.

REV #	DATE	DESCRIPTION
01	7/14/23	REVISED PER CITY OF ANN ARBOR COMMENTS
02	8/24/23	REVISED PER CITY OF ANN ARBOR COMMENTS
03	8/28/23	REVISED PER CITY OF ANN ARBOR COMMENTS
04	9/19/23	REVISED TO AVOID WATER VALVE SHTS 21 & 24



THE LOCATIONS OF EXISTING UNDERGROUND UTILITIES ARE SHOWN IN AN APPROXIMATE WAY ONLY AND HAVE NOT BEEN INDEPENDENTLY VERIFIED. THE CONTRACTOR SHALL DETERMINE THE EXACT LOCATION OF ALL EXISTING UTILITIES BEFORE COMMENCING WORK, AND AGREES TO BE FULLY RESPONSIBLE FOR ANY AND ALL DAMAGES WHICH MIGHT BE OCCASIONED BY THE CONTRACTOR'S FAILURE TO EXACTLY LOCATE AND PRESERVE ANY AND ALL UNDERGROUND UTILITIES.

**METRO ENGINEERING SOLUTIONS**  
33900 SCHOOLCRAFT RD  
LIVONIA, MICHIGAN 48150  
PHONE: 734.483.1427 FAX: 734.483.3431  
www.metroes.net

SOUTH ROUTE - WEST OF U.S. 23	
MES JOB#	1043-22
DRAWN	KMM
PLOT SCALE	1" = 50'
CHECKED	JB
PLAN DATE	5/26/2023

ANN ARBOR SPARK  
CORRIDOR FIBER OPTIC BACKBONE PROJECT  
ANN ARBOR  
WASHTENAW COUNTY, MI

PERMITS REQUIRED:

<input checked="" type="checkbox"/> CITY OF ANN ARBOR	<input type="checkbox"/> CITY OF YPSILANTI	<input type="checkbox"/> EGLE
<input type="checkbox"/> WASHTENAW COUNTY	<input type="checkbox"/> YPSILANTI TOWNSHIP	<input type="checkbox"/> RR
<input checked="" type="checkbox"/> WASHTENAW COUNTY DRAIN	<input type="checkbox"/> PITTSFIELD TOWNSHIP	<input checked="" type="checkbox"/> MDOT

SHEET INFORMATION

TOTAL SHEETS	SHEET NO.
42	27

K:\2022\1043 JOB FOLDERS\1043-22-0320\DWG\1043-22-0320_DS.dwg; 8/28/2023 10:38 AM;

K:\2022\1043 JOB FOLDERS\1043-22-0320\DWG\1043-22-0320_DS.dwg; 8/28/2023 10:38 AM;



Know what's below.  
Call before you dig.

THE LOCATIONS OF EXISTING UNDERGROUND UTILITIES ARE SHOWN IN AN APPROXIMATE WAY ONLY AND HAVE NOT BEEN INDEPENDENTLY VERIFIED. THE CONTRACTOR SHALL DETERMINE THE EXACT LOCATION OF ALL EXISTING UTILITIES BEFORE COMMENCING WORK, AND AGREES TO BE FULLY RESPONSIBLE FOR ANY AND ALL DAMAGES WHICH MIGHT BE OCCASIONED BY THE CONTRACTOR'S FAILURE TO EXACTLY LOCATE AND PRESERVE ANY AND ALL UNDERGROUND UTILITIES.



33900 SCHOOLCRAFT RD  
LIVONIA, MICHIGAN 48150  
PHONE: 734.483.1427 FAX: 734.483.3431  
www.metroes.net

SOUTH ROUTE - WEST OF U.S. 23	
MES JOB# 1043-22	DRAWN — KMM
PLOT SCALE = 1" = 50'	CHECKED - JB
PLAN DATE = 5/26/2023	

ANN ARBOR SPARK CORRIDOR FIBER OPTIC BACKBONE PROJECT ANN ARBOR WASHTENAW COUNTY, MI
-----------------------------------------------------------------------------------------------

PERMITS REQUIRED:		
<input checked="" type="checkbox"/> CITY OF ANN ARBOR	<input type="checkbox"/> CITY OF YPSILANTI	<input type="checkbox"/> EGLE
<input type="checkbox"/> WASHTENAW COUNTY	<input type="checkbox"/> YPSILANTI TOWNSHIP	<input type="checkbox"/> RR
<input checked="" type="checkbox"/> WASHTENAW COUNTY DRAIN	<input type="checkbox"/> PITTSFIELD TOWNSHIP	<input checked="" type="checkbox"/> MDOT

SHEET INFORMATION	
TOTAL SHEETS	SHEET NO.
42	28

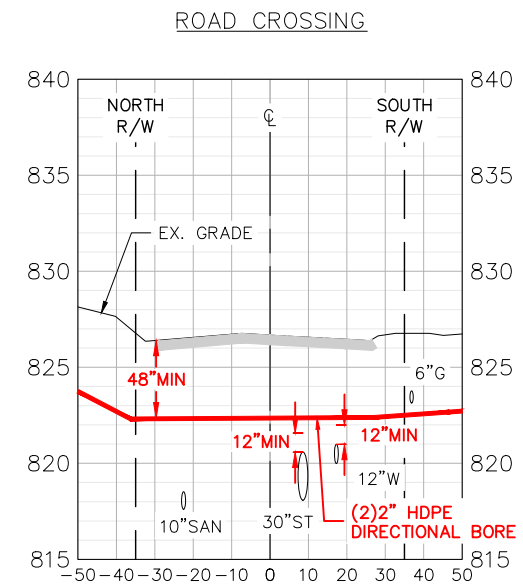

PACKARD ST  
LOOKING EAST  
1"=50' HORIZONTAL  
1"=10' VERTICAL

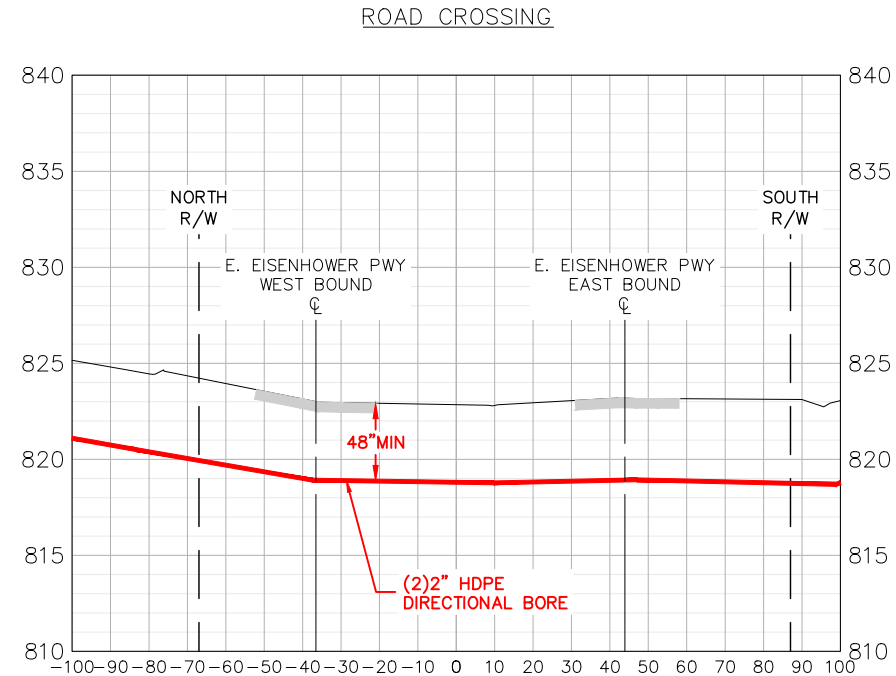

E. EISENHOWER PWY  
LOOKING EAST  
1"=50' HORIZONTAL  
1"=10' VERTICAL

REVISION		
REV #	DATE	DESCRIPTION
01	7/14/23	REVISED PER CITY OF ANN ARBOR COMMENTS
02	8/24/23	REVISED PER CITY OF ANN ARBOR COMMENTS
03	8/28/23	REVISED PER CITY OF ANN ARBOR COMMENTS
04	9/19/23	REVISED TO AVOID WATER VALVE SHTS 21 & 24



CITY OF ANN ARBOR  
SEC:10 T:03S R:06E

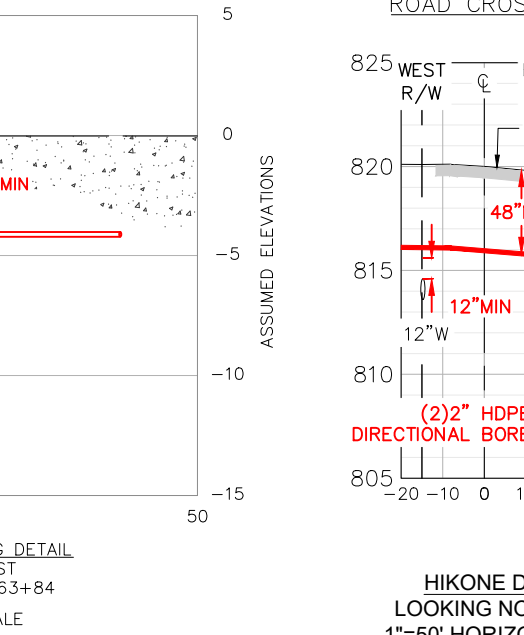
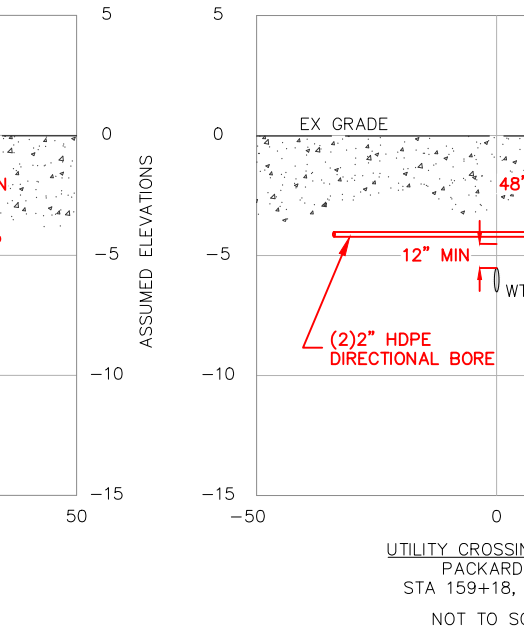
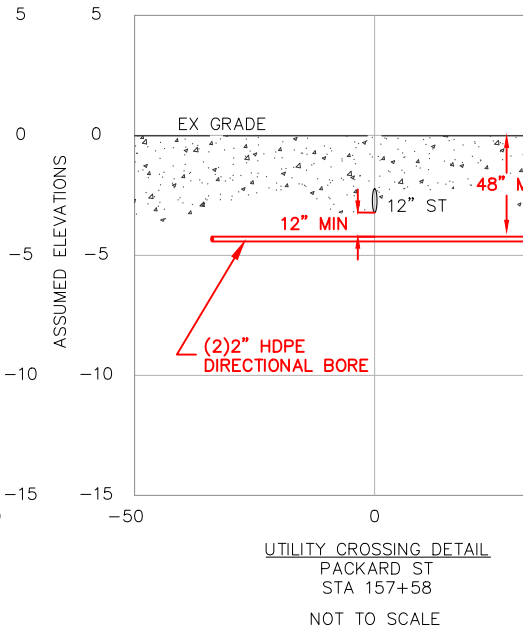
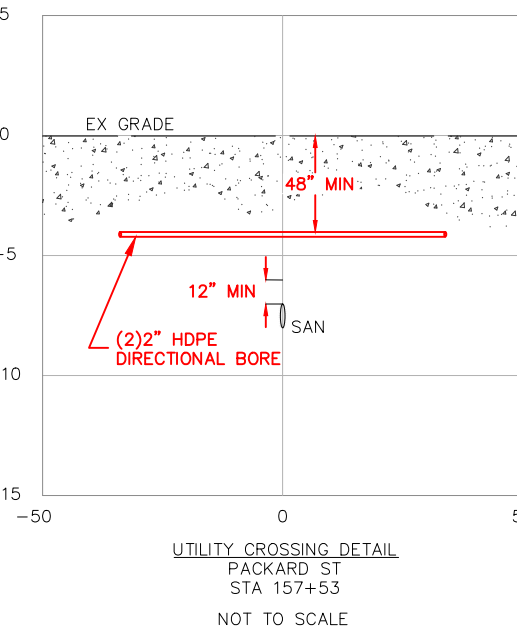
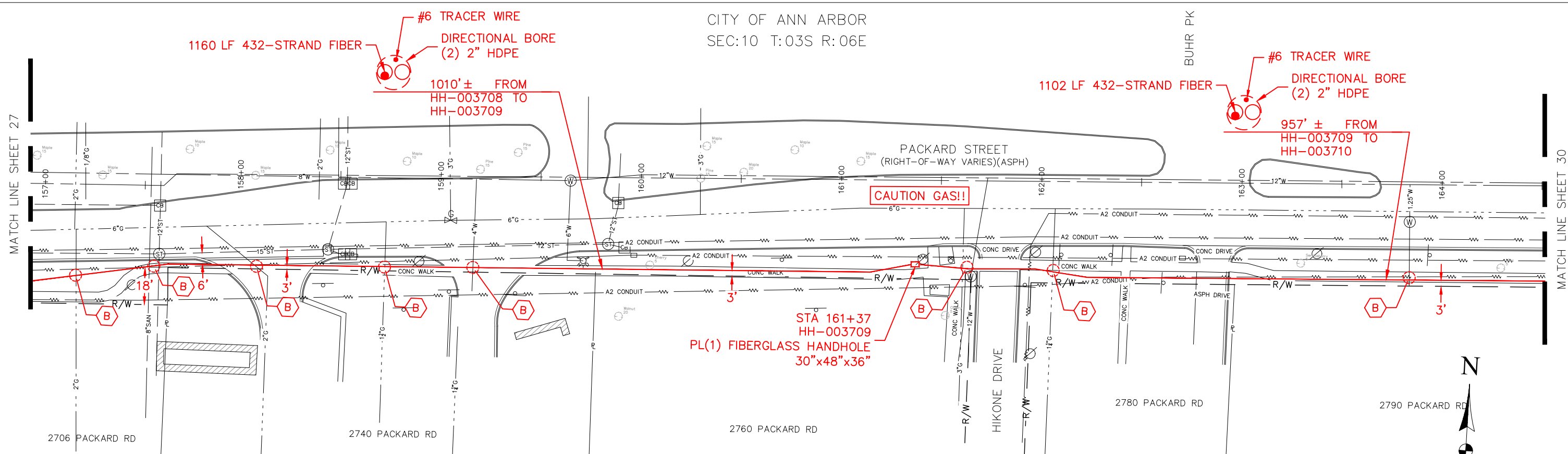

- UTILITY CROSSING/POTHOLE NOTES**
- (A)** POTHOLE. REMOVE & REPLACE (1) SQFT ASPH ROAD.
  - (B)** POTHOLE. REMOVE & REPLACE (1) FLAG CONC WALK.
  - (C)** POTHOLE. REMOVE & REPLACE GREENBELT.
  - (D)** NO POTHOLE NECESSARY. UTILITY DEPTH TO BE VERIFIED AT NEAREST STRUCTURE.

REV #	DATE	DESCRIPTION
01	7/14/23	REVISED PER CITY OF ANN ARBOR COMMENTS
02	8/24/23	REVISED PER CITY OF ANN ARBOR COMMENTS
03	8/28/23	REVISED PER CITY OF ANN ARBOR COMMENTS
04	9/19/23	REVISED TO AVOID WATER VALVE SHTS 21 & 24



THE LOCATIONS OF EXISTING UNDERGROUND UTILITIES ARE SHOWN IN AN APPROXIMATE WAY ONLY AND HAVE NOT BEEN INDEPENDENTLY VERIFIED. THE CONTRACTOR SHALL DETERMINE THE EXACT LOCATION OF ALL EXISTING UTILITIES BEFORE COMMENCING WORK, AND AGREES TO BE FULLY RESPONSIBLE FOR ANY AND ALL DAMAGES WHICH MIGHT BE OCCASIONED BY THE CONTRACTOR'S FAILURE TO EXACTLY LOCATE AND PRESERVE ANY AND ALL UNDERGROUND UTILITIES.

**METRO ENGINEERING SOLUTIONS**  
33900 SCHOOLCRAFT RD  
LIVONIA, MICHIGAN 48150  
PHONE: 734.483.1427 FAX: 734.483.3431  
www.metroes.net

SOUTH ROUTE - WEST OF U.S. 23	
MES JOB# 1043-22	DRAWN - KMM
PLOT SCALE = 1" = 50'	CHECKED - JB
PLAN DATE = 5/26/2023	

ANN ARBOR SPARK  
CORRIDOR FIBER OPTIC BACKBONE PROJECT  
ANN ARBOR  
WASHTENAW COUNTY, MI

PERMITS REQUIRED:

<input checked="" type="checkbox"/> CITY OF ANN ARBOR	<input type="checkbox"/> CITY OF YPSILANTI	<input type="checkbox"/> EGLE
<input type="checkbox"/> WASHTENAW COUNTY	<input type="checkbox"/> YPSILANTI TOWNSHIP	<input type="checkbox"/> RR
<input checked="" type="checkbox"/> WASHTENAW COUNTY DRAIN	<input type="checkbox"/> PITTSFIELD TOWNSHIP	<input checked="" type="checkbox"/> MDOT

SHEET INFORMATION

TOTAL SHEETS	SHEET NO.
42	29

K:\2022\1043 JOB FOLDERS\1043-22-0320\DWG\1043-22-0320_DS.dwg; 8/28/2023 10:38 AM;

MATCH LINE SHEET 29

MATCH LINE SHEET 31

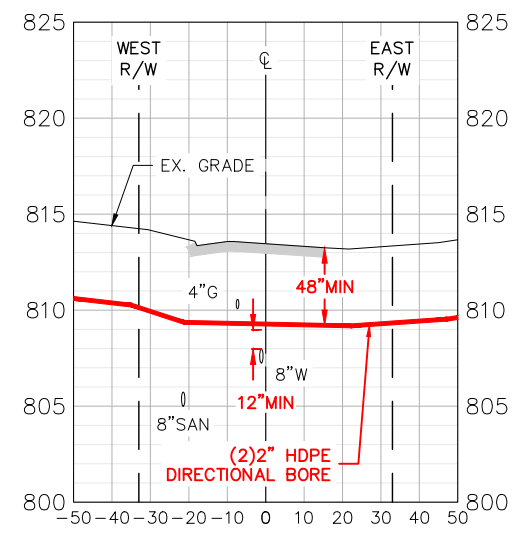
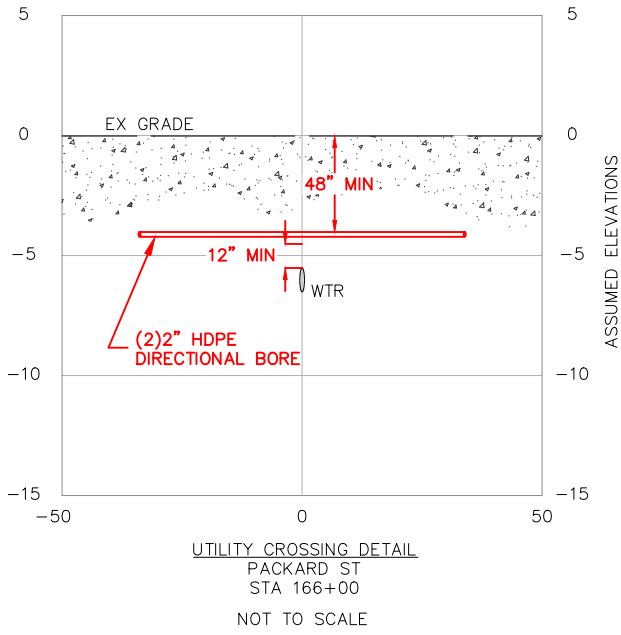
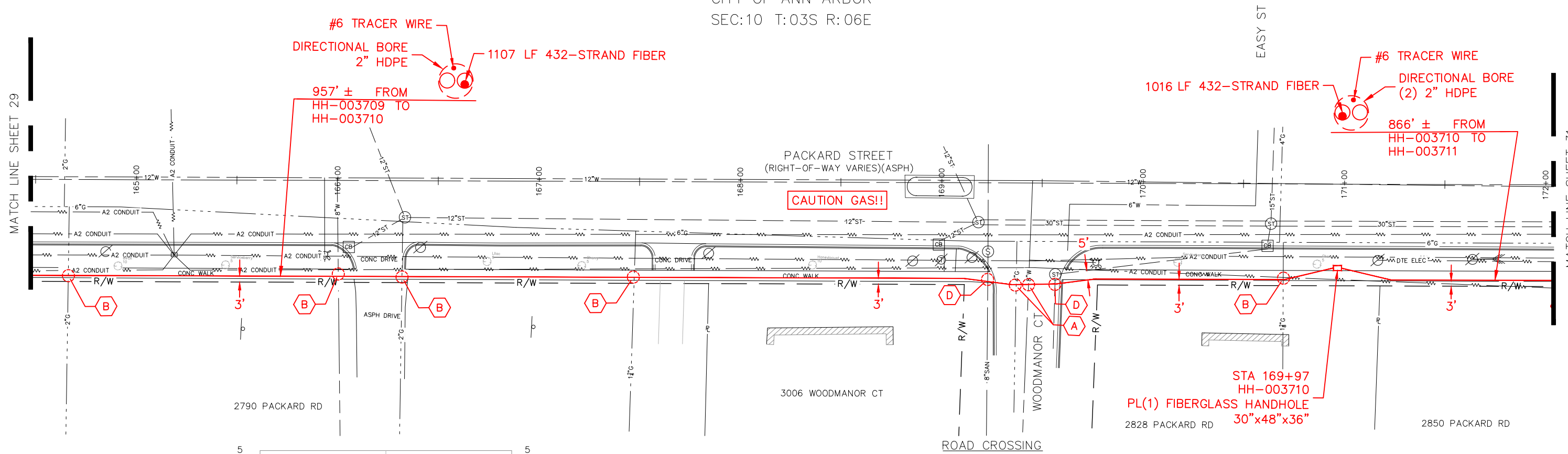

- UTILITY CROSSING/POTHOLE NOTES**
- (A)** POT HOLE. REMOVE & REPLACE (1) SQFT ASPH ROAD.
  - (B)** POT HOLE. REMOVE & REPLACE (1) FLAG CONC WALK.
  - (C)** POT HOLE. REMOVE & REPLACE GREENBELT.
  - (D)** NO POT HOLE NECESSARY. UTILITY DEPTH TO BE VERIFIED AT NEAREST STRUCTURE.

REVISION		
REV #	DATE	DESCRIPTION
01	7/14/23	REVISED PER CITY OF ANN ARBOR COMMENTS
02	8/24/23	REVISED PER CITY OF ANN ARBOR COMMENTS
03	8/28/23	REVISED PER CITY OF ANN ARBOR COMMENTS
04	9/19/23	REVISED TO AVOID WATER VALVE SHTS 21 & 24



THE LOCATIONS OF EXISTING UNDERGROUND UTILITIES ARE SHOWN IN AN APPROXIMATE WAY ONLY AND HAVE NOT BEEN INDEPENDENTLY VERIFIED. THE CONTRACTOR SHALL DETERMINE THE EXACT LOCATION OF ALL EXISTING UTILITIES BEFORE COMMENCING WORK, AND AGREES TO BE FULLY RESPONSIBLE FOR ANY AND ALL DAMAGES WHICH MIGHT BE OCCASIONED BY THE CONTRACTOR'S FAILURE TO EXACTLY LOCATE AND PRESERVE ANY AND ALL UNDERGROUND UTILITIES.

**METRO ENGINEERING SOLUTIONS**  
33900 SCHOOLCRAFT RD  
LIVONIA, MICHIGAN 48150  
PHONE: 734.483.1427 FAX: 734.483.3431  
www.metroes.net

SOUTH ROUTE - WEST OF U.S. 23	
MES JOB# 1043-22	DRAWN - KMM
PLOT SCALE = 1" = 50'	CHECKED - JB
PLAN DATE = 5/26/2023	

ANN ARBOR SPARK  
CORRIDOR FIBER OPTIC BACKBONE PROJECT  
ANN ARBOR  
WASHTENAW COUNTY, MI

PERMITS REQUIRED:

<input checked="" type="checkbox"/> CITY OF ANN ARBOR	<input type="checkbox"/> CITY OF YPSILANTI	<input type="checkbox"/> EGLE
<input type="checkbox"/> WASHTENAW COUNTY	<input type="checkbox"/> YPSILANTI TOWNSHIP	<input type="checkbox"/> RR
<input checked="" type="checkbox"/> WASHTENAW COUNTY DRAIN	<input type="checkbox"/> PITTSFIELD TOWNSHIP	<input checked="" type="checkbox"/> MDOT

SHEET INFORMATION

TOTAL SHEETS	SHEET NO.
42	30

K:\2022\1043 JOB FOLDERS\1043-22-0320\DWG\1043-22-0320_DS.dwg; 8/28/2023 10:38 AM;



CITY OF ANN ARBOR  
SEC:10 T:03S R:06E

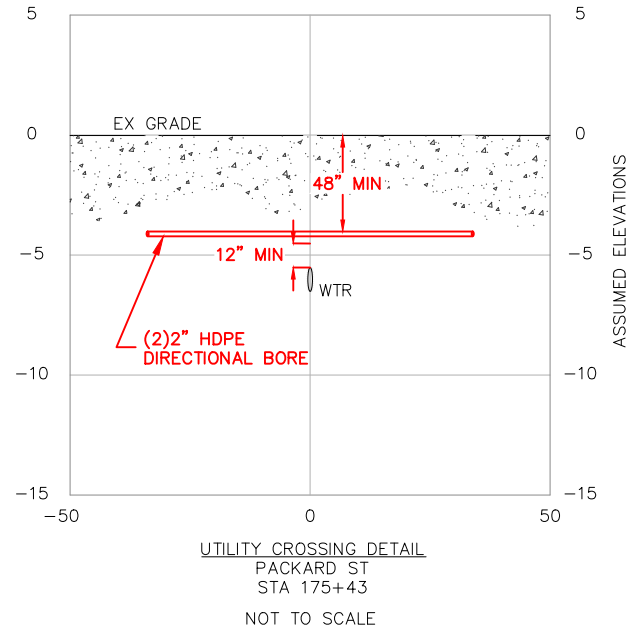
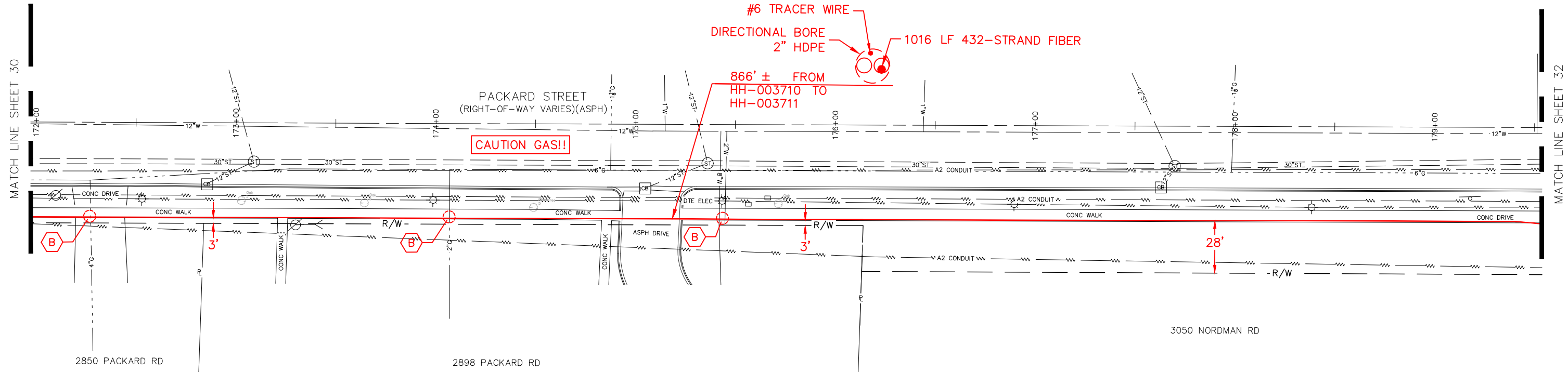

- UTILITY CROSSING/POTHOLE NOTES**
- A** POTHOLE. REMOVE & REPLACE (1) SQFT ASPH ROAD.
  - B** POTHOLE. REMOVE & REPLACE (1) FLAG CONC WALK.
  - C** POTHOLE. REMOVE & REPLACE GREENBELT.
  - D** NO POTHOLE NECESSARY. UTILITY DEPTH TO BE VERIFIED AT NEAREST STRUCTURE.

REVISION		
REV #	DATE	DESCRIPTION
01	7/14/23	REVISED PER CITY OF ANN ARBOR COMMENTS
02	8/24/23	REVISED PER CITY OF ANN ARBOR COMMENTS
03	8/28/23	REVISED PER CITY OF ANN ARBOR COMMENTS
04	9/19/23	REVISED TO AVOID WATER VALVE SHTS 21 & 24



THE LOCATIONS OF EXISTING UNDERGROUND UTILITIES ARE SHOWN IN AN APPROXIMATE WAY ONLY AND HAVE NOT BEEN INDEPENDENTLY VERIFIED. THE CONTRACTOR SHALL DETERMINE THE EXACT LOCATION OF ALL EXISTING UTILITIES BEFORE COMMENCING WORK, AND AGREES TO BE FULLY RESPONSIBLE FOR ANY AND ALL DAMAGES WHICH MIGHT BE OCCASIONED BY THE CONTRACTOR'S FAILURE TO EXACTLY LOCATE AND PRESERVE ANY AND ALL UNDERGROUND UTILITIES.

**METRO ENGINEERING SOLUTIONS**  
33900 SCHOOLCRAFT RD  
LIVONIA, MICHIGAN 48150  
PHONE: 734.483.1427 FAX: 734.483.3431  
www.metroes.net

SOUTH ROUTE - WEST OF U.S. 23	
MES JOB#	1043-22
DRAWN	— KMM
PLOT SCALE	= 1" = 50'
CHECKED	- JB
PLAN DATE	= 5/26/2023

ANN ARBOR SPARK  
CORRIDOR FIBER OPTIC BACKBONE PROJECT  
ANN ARBOR  
WASHTENAW COUNTY, MI

PERMITS REQUIRED:

<input checked="" type="checkbox"/> CITY OF ANN ARBOR	<input type="checkbox"/> CITY OF YPSILANTI	<input type="checkbox"/> EGLE
<input type="checkbox"/> WASHTENAW COUNTY	<input type="checkbox"/> YPSILANTI TOWNSHIP	<input type="checkbox"/> RR
<input checked="" type="checkbox"/> WASHTENAW COUNTY DRAIN	<input type="checkbox"/> PITTSFIELD TOWNSHIP	<input checked="" type="checkbox"/> MDOT

SHEET INFORMATION

TOTAL SHEETS	SHEET NO.
42	31

K:\2022\1043 JOB FOLDERS\1043-22-0320\DWG\1043-22-0320_DS.dwg; 8/28/2023 10:38 AM;

CITY OF ANN ARBOR  
SEC:10 T:03S R:06E

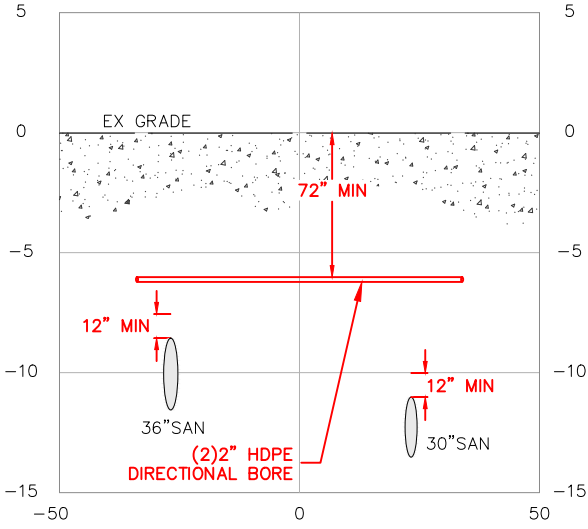
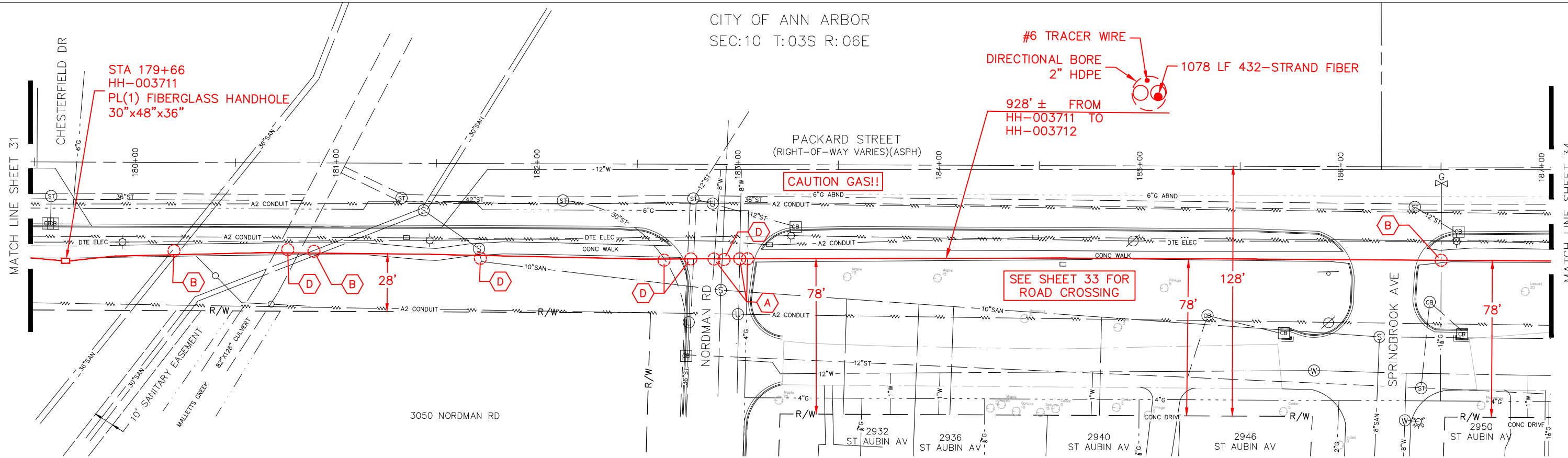

UTILITY CROSSING DETAIL  
PACKARD ST  
STA 180+18, 180+89  
NOT TO SCALE

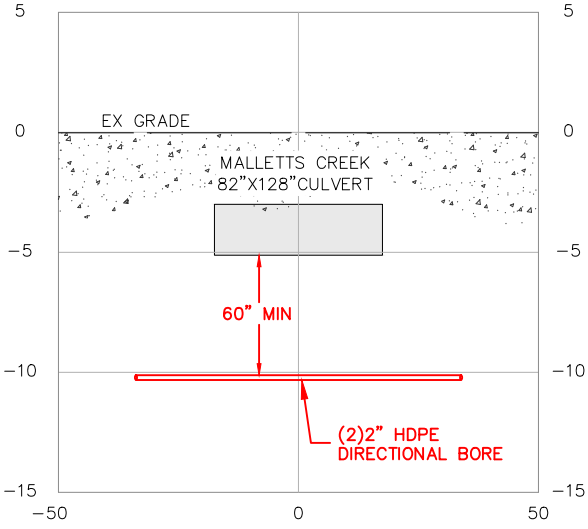

DRAIN CROSSING DETAIL  
MALLETT'S CREEK  
STA 180+76  
NOT TO SCALE

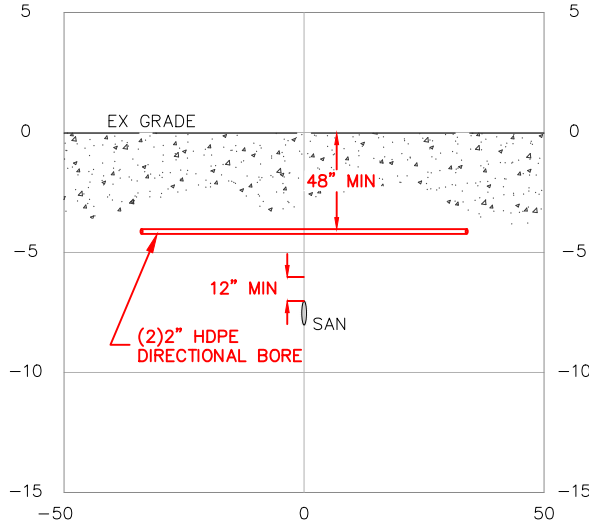

UTILITY CROSSING DETAIL  
WASHTEAW AVE  
STA 181+72  
NOT TO SCALE

- UTILITY CROSSING/POTHOLE NOTES**
- (A)** POT HOLE. REMOVE & REPLACE (1) SQFT ASPH ROAD.
  - (B)** POT HOLE. REMOVE & REPLACE (1) FLAG CONC WALK.
  - (C)** POT HOLE. REMOVE & REPLACE GREENBELT.
  - (D)** NO POT HOLE NECESSARY. UTILITY DEPTH TO BE VERIFIED AT NEAREST STRUCTURE.

WCWRC PERMIT #DRA2023-00111

REVISION		
REV #	DATE	DESCRIPTION
01	7/14/23	REVISED PER CITY OF ANN ARBOR COMMENTS
02	8/24/23	REVISED PER CITY OF ANN ARBOR COMMENTS
03	8/28/23	REVISED PER CITY OF ANN ARBOR COMMENTS
04	9/19/23	REVISED TO AVOID WATER VALVE SHTS 21 & 24



THE LOCATIONS OF EXISTING UNDERGROUND UTILITIES ARE SHOWN IN AN APPROXIMATE WAY ONLY AND HAVE NOT BEEN INDEPENDENTLY VERIFIED. THE CONTRACTOR SHALL DETERMINE THE EXACT LOCATION OF ALL EXISTING UTILITIES BEFORE COMMENCING WORK, AND AGREES TO BE FULLY RESPONSIBLE FOR ANY AND ALL DAMAGES WHICH MIGHT BE OCCASIONED BY THE CONTRACTOR'S FAILURE TO EXACTLY LOCATE AND PRESERVE ANY AND ALL UNDERGROUND UTILITIES.

**METRO ENGINEERING SOLUTIONS**  
33900 SCHOOLCRAFT RD  
LIVONIA, MICHIGAN 48150  
PHONE: 734.483.1427 FAX: 734.483.3431  
www.metroes.net

SOUTH ROUTE - WEST OF U.S. 23	
MES JOB# 1043-22	DRAWN - KMM
PLOT SCALE = 1" = 50'	CHECKED - JB
PLAN DATE = 5/26/2023	

ANN ARBOR SPARK  
CORRIDOR FIBER OPTIC BACKBONE PROJECT  
ANN ARBOR  
WASHTEAW COUNTY, MI

PERMITS REQUIRED:

<input checked="" type="checkbox"/> CITY OF ANN ARBOR	<input type="checkbox"/> CITY OF YPSILANTI	<input type="checkbox"/> EGLE
<input type="checkbox"/> WASHTEAW COUNTY	<input type="checkbox"/> YPSILANTI TOWNSHIP	<input type="checkbox"/> RR
<input checked="" type="checkbox"/> WASHTEAW COUNTY DRAIN	<input type="checkbox"/> PITTSFIELD TOWNSHIP	<input checked="" type="checkbox"/> MDOT

SHEET INFORMATION

TOTAL SHEETS	SHEET NO.
42	32

K:\2022\1043 JOB FOLDERS\1043-22-0320\DWG\1043-22-0320_DS.dwg; 8/28/2023 10:38 AM;

K:\2022\1043 JOB FOLDERS\1043-22-0320\DWG\1043-22-0320_DS.dwg; 8/28/2023 10:38 AM;

ROAD CROSSING

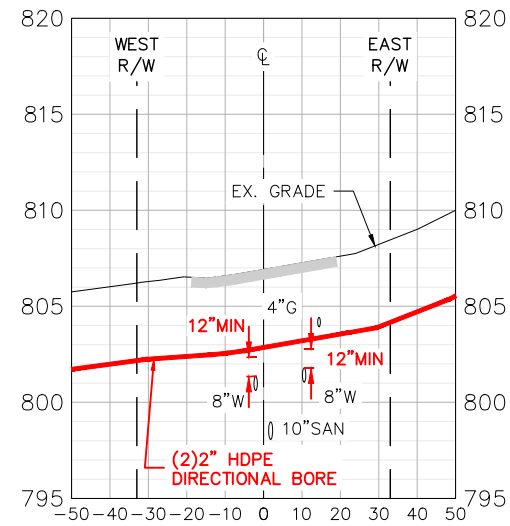

NORDMAN RD  
LOOKING NORTH  
1"=50' HORIZONTAL  
1"=10' VERTICAL

ROAD CROSSING

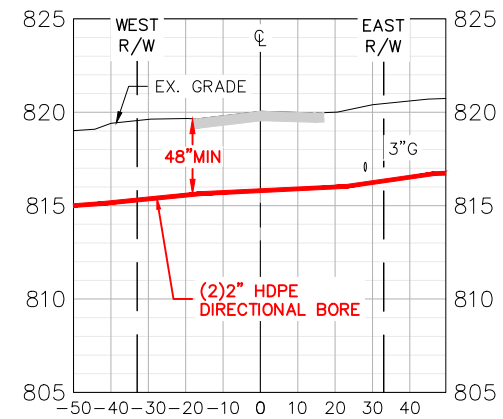

SPRINGBROOK AVE  
LOOKING NORTH  
1"=50' HORIZONTAL  
1"=10' VERTICAL



Know what's below.  
Call before you dig.

THE LOCATIONS OF EXISTING UNDERGROUND UTILITIES ARE SHOWN IN AN APPROXIMATE WAY ONLY AND HAVE NOT BEEN INDEPENDENTLY VERIFIED. THE CONTRACTOR SHALL DETERMINE THE EXACT LOCATION OF ALL EXISTING UTILITIES BEFORE COMMENCING WORK, AND AGREES TO BE FULLY RESPONSIBLE FOR ANY AND ALL DAMAGES WHICH MIGHT BE OCCASIONED BY THE CONTRACTOR'S FAILURE TO EXACTLY LOCATE AND PRESERVE ANY AND ALL UNDERGROUND UTILITIES.

**METRO ENGINEERING SOLUTIONS**  
33900 SCHOOLCRAFT RD  
LIVONIA, MICHIGAN 48150  
PHONE: 734.483.1427 FAX: 734.483.3431  
www.metroes.net

SOUTH ROUTE - WEST OF U.S. 23	
MES JOB# 1043-22	DRAWN — KMM
PLOT SCALE = 1" = 50'	CHECKED - JB
PLAN DATE = 5/26/2023	

ANN ARBOR SPARK  
CORRIDOR FIBER OPTIC BACKBONE PROJECT  
ANN ARBOR  
WASHTENAW COUNTY, MI

PERMITS REQUIRED:		
<input checked="" type="checkbox"/> CITY OF ANN ARBOR	<input type="checkbox"/> CITY OF YPSILANTI	<input type="checkbox"/> EGLE
<input type="checkbox"/> WASHTENAW COUNTY	<input type="checkbox"/> YPSILANTI TOWNSHIP	<input type="checkbox"/> RR
<input checked="" type="checkbox"/> WASHTENAW COUNTY DRAIN	<input type="checkbox"/> PITTSFIELD TOWNSHIP	<input checked="" type="checkbox"/> MDOT

SHEET INFORMATION	
TOTAL SHEETS	SHEET NO.
42	33

REVISION		
REV #	DATE	DESCRIPTION
01	7/14/23	REVISED PER CITY OF ANN ARBOR COMMENTS
02	8/24/23	REVISED PER CITY OF ANN ARBOR COMMENTS
03	8/28/23	REVISED PER CITY OF ANN ARBOR COMMENTS
04	9/19/23	REVISED TO AVOID WATER VALVE SHTS 21 & 24

CITY OF ANN ARBOR

SEC:10 T:03S R:06E

#6 TRACER WIRE

DIRECTIONAL BORE 2" HDPE 1075 LF 432-STRAND FIBER

#6 TRACER WIRE  
DIRECTIONAL BORE 2" HDPE 1078 LF 432-STRAND FIBER

928' ± FROM HH-003711 TO HH-003712

STA 188+98 HH-003712 PL(1) FIBERGLASS HANDHOLE 30"x48"x36"

925' ± FROM HH-003712 TO HH-003713

CAUTION GAS!!

MATCH LINE SHEET 32

MATCH LINE SHEET 35

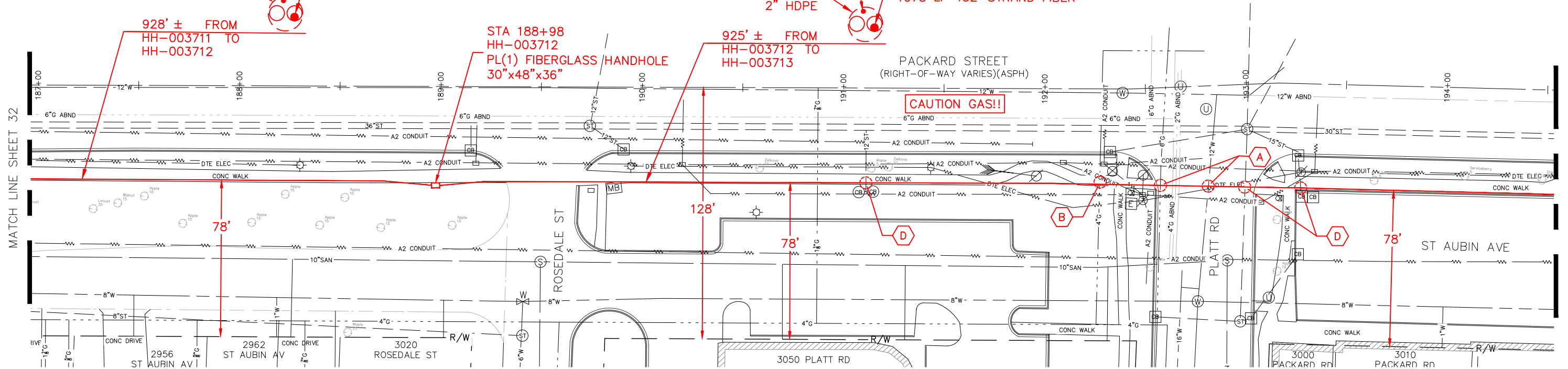

ROAD CROSSING

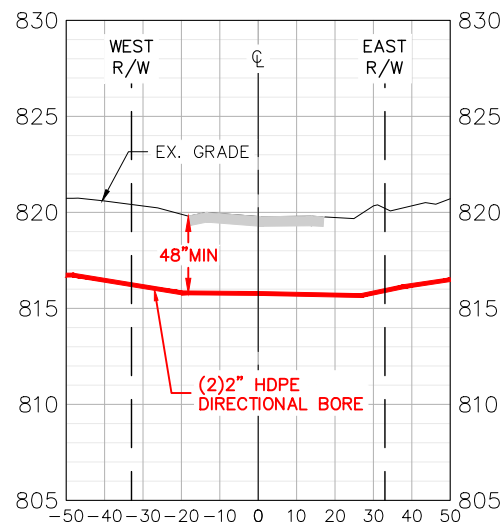

ROSEDALE ST  
LOOKING NORTH  
1"=50' HORIZONTAL  
1"=10' VERTICAL

ROAD CROSSING

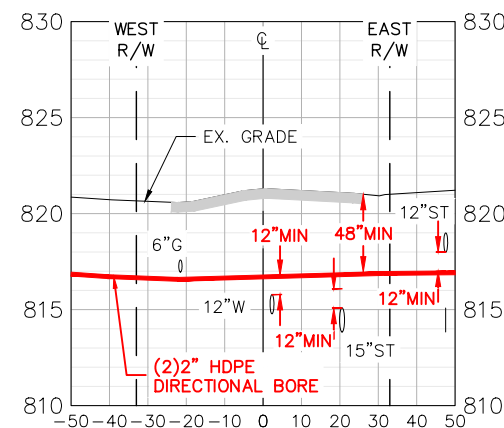

PLATT RD  
LOOKING NORTH  
1"=50' HORIZONTAL  
1"=10' VERTICAL

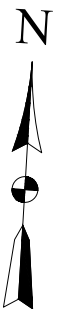

- UTILITY CROSSING/POTHOLE NOTES**
- A** POTHOLE. REMOVE & REPLACE (1) SQFT ASPH ROAD.
  - B** POTHOLE. REMOVE & REPLACE (1) FLAG CONC WALK.
  - C** POTHOLE. REMOVE & REPLACE GREENBELT.
  - D** NO POTHOLE NECESSARY. UTILITY DEPTH TO BE VERIFIED AT NEAREST STRUCTURE.

REVISION		
REV #	DATE	DESCRIPTION
01	7/14/23	REVISED PER CITY OF ANN ARBOR COMMENTS
02	8/24/23	REVISED PER CITY OF ANN ARBOR COMMENTS
03	8/28/23	REVISED PER CITY OF ANN ARBOR COMMENTS
04	9/19/23	REVISED TO AVOID WATER VALVE SHTS 21 & 24



THE LOCATIONS OF EXISTING UNDERGROUND UTILITIES ARE SHOWN IN AN APPROXIMATE WAY ONLY AND HAVE NOT BEEN INDEPENDENTLY VERIFIED. THE CONTRACTOR SHALL DETERMINE THE EXACT LOCATION OF ALL EXISTING UTILITIES BEFORE COMMENCING WORK, AND AGREES TO BE FULLY RESPONSIBLE FOR ANY AND ALL DAMAGES WHICH MIGHT BE OCCASIONED BY THE CONTRACTOR'S FAILURE TO EXACTLY LOCATE AND PRESERVE ANY AND ALL UNDERGROUND UTILITIES.

**METRO ENGINEERING SOLUTIONS**

33900 SCHOOLCRAFT RD  
LIVONIA, MICHIGAN 48150  
PHONE: 734.483.1427 FAX: 734.483.3431  
www.metroes.net

SOUTH ROUTE - WEST OF U.S. 23	
MES JOB#	1043-22
DRAWN	KMM
PLOT SCALE	1" = 50'
CHECKED	JB
PLAN DATE	5/26/2023

ANN ARBOR SPARK  
CORRIDOR FIBER OPTIC BACKBONE PROJECT  
ANN ARBOR  
WASHTENAW COUNTY, MI

PERMITS REQUIRED:

<input checked="" type="checkbox"/> CITY OF ANN ARBOR	<input type="checkbox"/> CITY OF YPSILANTI	<input type="checkbox"/> EGLE
<input type="checkbox"/> WASHTENAW COUNTY	<input type="checkbox"/> YPSILANTI TOWNSHIP	<input type="checkbox"/> RR
<input checked="" type="checkbox"/> WASHTENAW COUNTY DRAIN	<input type="checkbox"/> PITTSFIELD TOWNSHIP	<input checked="" type="checkbox"/> MDOT

SHEET INFORMATION

TOTAL SHEETS	SHEET NO.
42	34

K:\2022\1043 JOB FOLDERS\1043-22-0320\DWG\1043-22-0320_DS.dwg; 8/28/2023 10:38 AM;

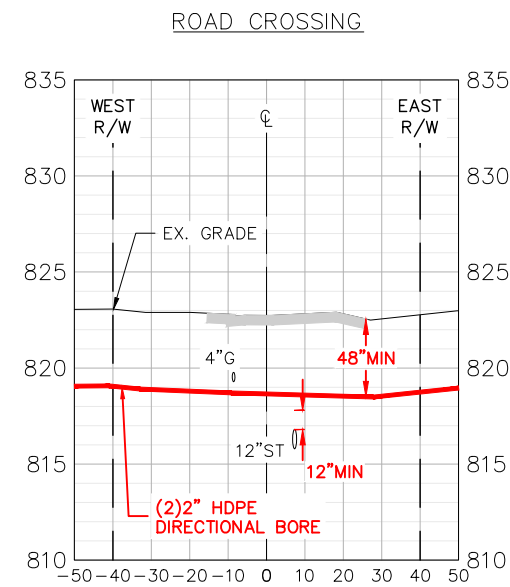
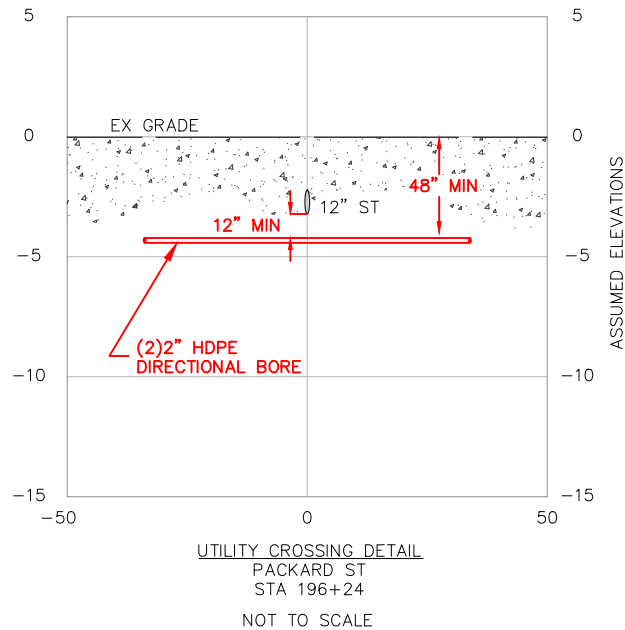
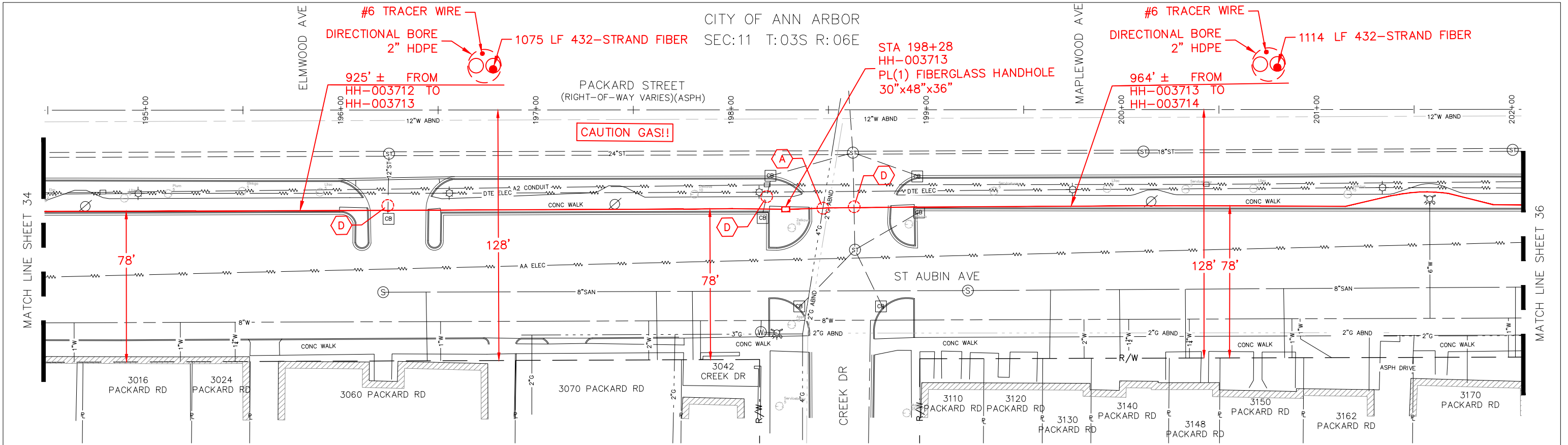

- UTILITY CROSSING/POTHOLE NOTES**
- A** POTHOLE. REMOVE & REPLACE (1) SQFT ASPH ROAD.
  - B** POTHOLE. REMOVE & REPLACE (1) FLAG CONC WALK.
  - C** POTHOLE. REMOVE & REPLACE GREENBELT.
  - D** NO POTHOLE NECESSARY. UTILITY DEPTH TO BE VERIFIED AT NEAREST STRUCTURE.

REVISION		
REV #	DATE	DESCRIPTION
01	7/14/23	REVISED PER CITY OF ANN ARBOR COMMENTS
02	8/24/23	REVISED PER CITY OF ANN ARBOR COMMENTS
03	8/28/23	REVISED PER CITY OF ANN ARBOR COMMENTS
04	9/19/23	REVISED TO AVOID WATER VALVE SHTS 21 & 24



THE LOCATIONS OF EXISTING UNDERGROUND UTILITIES ARE SHOWN IN AN APPROXIMATE WAY ONLY AND HAVE NOT BEEN INDEPENDENTLY VERIFIED. THE CONTRACTOR SHALL DETERMINE THE EXACT LOCATION OF ALL EXISTING UTILITIES BEFORE COMMENCING WORK, AND AGREES TO BE FULLY RESPONSIBLE FOR ANY AND ALL DAMAGES WHICH MIGHT BE OCCASIONED BY THE CONTRACTOR'S FAILURE TO EXACTLY LOCATE AND PRESERVE ANY AND ALL UNDERGROUND UTILITIES.

**METRO ENGINEERING SOLUTIONS**  
 33900 SCHOOLCRAFT RD  
 LIVONIA, MICHIGAN 48150  
 PHONE: 734.483.1427 FAX: 734.483.3431  
 www.metroes.net

SOUTH ROUTE - WEST OF U.S. 23	
MES JOB# 1043-22	DRAWN - KMM
PLOT SCALE = 1" = 50'	CHECKED - JB
PLAN DATE = 5/26/2023	

ANN ARBOR SPARK  
 CORRIDOR FIBER OPTIC BACKBONE PROJECT  
 ANN ARBOR  
 WASHTENAW COUNTY, MI

PERMITS REQUIRED:		
<input checked="" type="checkbox"/> CITY OF ANN ARBOR	<input type="checkbox"/> CITY OF YPSILANTI	<input type="checkbox"/> EGLE
<input type="checkbox"/> WASHTENAW COUNTY	<input type="checkbox"/> YPSILANTI TOWNSHIP	<input type="checkbox"/> RR
<input checked="" type="checkbox"/> WASHTENAW COUNTY DRAIN	<input type="checkbox"/> PITTSFIELD TOWNSHIP	<input checked="" type="checkbox"/> MDOT

SHEET INFORMATION	
TOTAL SHEETS	SHEET NO.
42	35



CITY OF ANN ARBOR  
SEC:11 T:03S R:06E

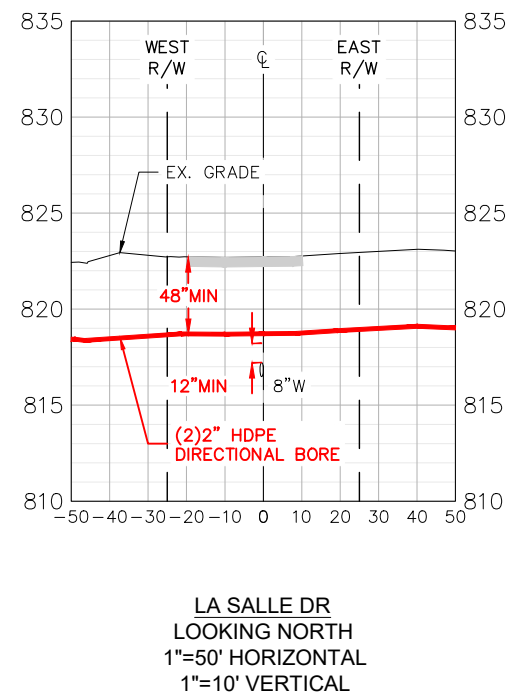
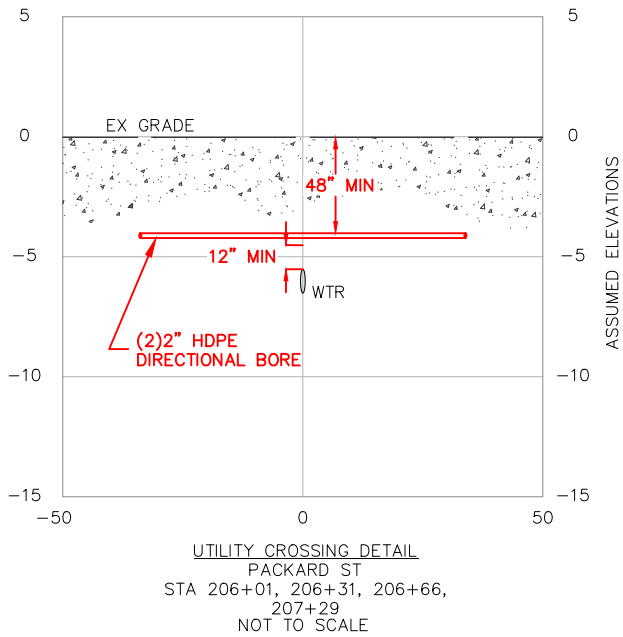
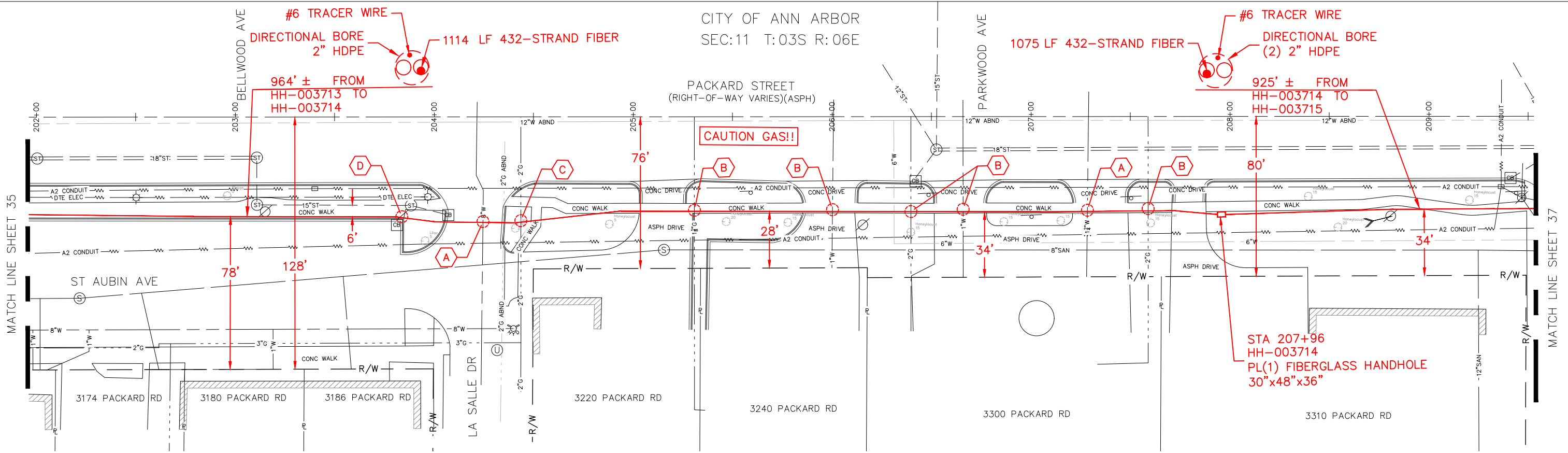

- UTILITY CROSSING/POTHOLE NOTES**
- (A)** POTHOLE. REMOVE & REPLACE (1) SQFT ASPH ROAD.
  - (B)** POTHOLE. REMOVE & REPLACE (1) FLAG CONC WALK.
  - (C)** POTHOLE. REMOVE & REPLACE GREENBELT.
  - (D)** NO POTHOLE NECESSARY. UTILITY DEPTH TO BE VERIFIED AT NEAREST STRUCTURE.

REVISION		
REV #	DATE	DESCRIPTION
01	7/14/23	REVISED PER CITY OF ANN ARBOR COMMENTS
02	8/24/23	REVISED PER CITY OF ANN ARBOR COMMENTS
03	8/28/23	REVISED PER CITY OF ANN ARBOR COMMENTS
04	9/19/23	REVISED TO AVOID WATER VALVE SHTS 21 & 24



Know what's below.  
Call before you dig.

THE LOCATIONS OF EXISTING UNDERGROUND UTILITIES ARE SHOWN IN AN APPROXIMATE WAY ONLY AND HAVE NOT BEEN INDEPENDENTLY VERIFIED. THE CONTRACTOR SHALL DETERMINE THE EXACT LOCATION OF ALL EXISTING UTILITIES BEFORE COMMENCING WORK, AND AGREES TO BE FULLY RESPONSIBLE FOR ANY AND ALL DAMAGES WHICH MIGHT BE OCCASIONED BY THE CONTRACTOR'S FAILURE TO EXACTLY LOCATE AND PRESERVE ANY AND ALL UNDERGROUND UTILITIES.

**METRO ENGINEERING SOLUTIONS**  
33900 SCHOOLCRAFT RD  
LIVONIA, MICHIGAN 48150  
PHONE: 734.483.1427 FAX: 734.483.3431  
www.metroes.net

SOUTH ROUTE - WEST OF U.S. 23	
MES JOB# 1043-22	DRAWN - KMM
PLOT SCALE = 1" = 50'	CHECKED - JB
PLAN DATE = 5/26/2023	

ANN ARBOR SPARK  
CORRIDOR FIBER OPTIC BACKBONE PROJECT  
ANN ARBOR  
WASHTENAW COUNTY, MI

PERMITS REQUIRED:

<input checked="" type="checkbox"/> CITY OF ANN ARBOR	<input type="checkbox"/> CITY OF YPSILANTI	<input type="checkbox"/> EGLE
<input type="checkbox"/> WASHTENAW COUNTY	<input type="checkbox"/> YPSILANTI TOWNSHIP	<input type="checkbox"/> RR
<input checked="" type="checkbox"/> WASHTENAW COUNTY DRAIN	<input type="checkbox"/> PITTSFIELD TOWNSHIP	<input checked="" type="checkbox"/> MDOT

SHEET INFORMATION

TOTAL SHEETS	SHEET NO.
42	36

K:\2022\1043 JOB FOLDERS\1043-22-0320\DWG\1043-22-0320_DS.dwg; 8/28/2023 10:38 AM;

CITY OF ANN ARBOR  
SEC:11 T:03S R:06E

PITTSFIELD BLVD

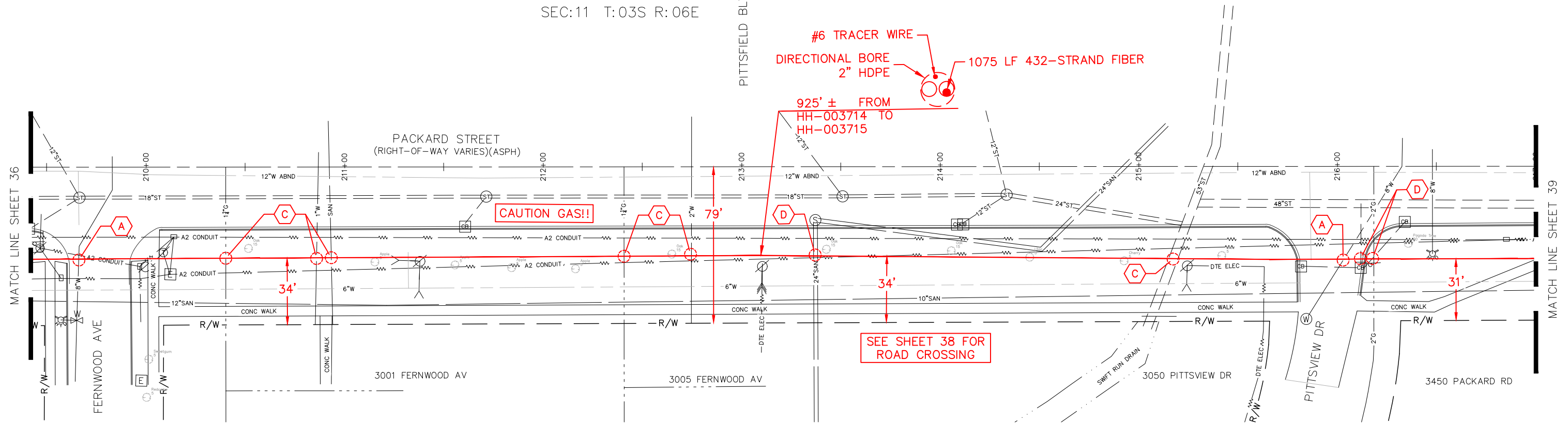

#6 TRACER WIRE  
DIRECTIONAL BORE  
2\"/>

925' ± FROM  
HH-003714 TO  
HH-003715

CAUTION GAS!!

SEE SHEET 38 FOR  
ROAD CROSSING

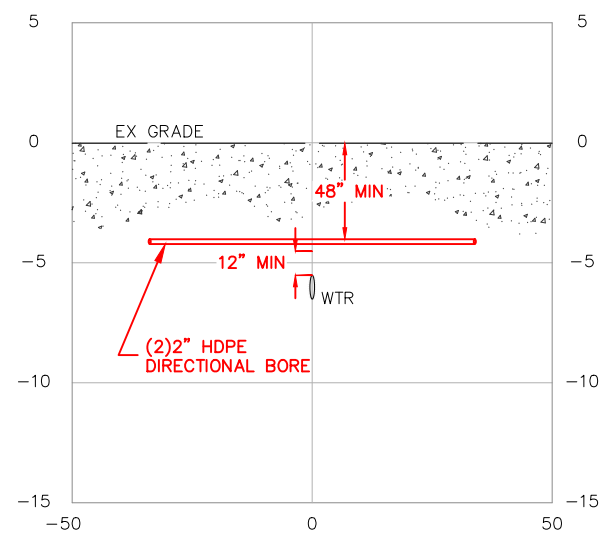

UTILITY CROSSING DETAIL  
PACKARD ST  
STA 210+87, 212+75  
NOT TO SCALE

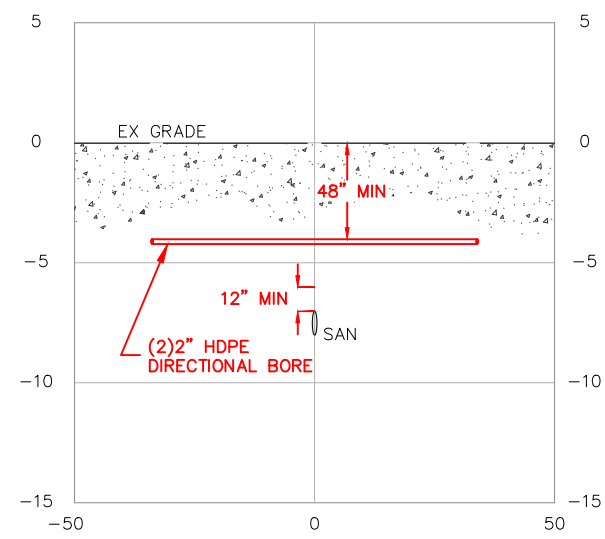

UTILITY CROSSING DETAIL  
PACKARD ST  
STA 210+92, 213+37  
NOT TO SCALE

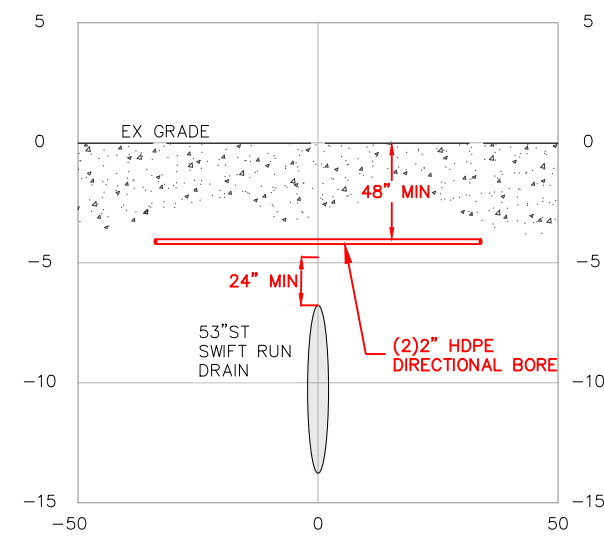

DRAIN CROSSING DETAIL  
SWIFT RUN  
STA 215+18  
NOT TO SCALE

- UTILITY CROSSING/POTHOLE NOTES**
- A** POTHOLE. REMOVE & REPLACE (1) SQFT ASPH ROAD.
  - B** POTHOLE. REMOVE & REPLACE (1) FLAG CONC WALK.
  - C** POTHOLE. REMOVE & REPLACE GREENBELT.
  - D** NO POTHOLE NECESSARY. UTILITY DEPTH TO BE VERIFIED AT NEAREST STRUCTURE.

WCWRC PERMIT #DRA2023-00112

REVISION		
REV #	DATE	DESCRIPTION
01	7/14/23	REVISED PER CITY OF ANN ARBOR COMMENTS
02	8/24/23	REVISED PER CITY OF ANN ARBOR COMMENTS
03	8/28/23	REVISED PER CITY OF ANN ARBOR COMMENTS
04	9/19/23	REVISED TO AVOID WATER VALVE SHTS 21 & 24



THE LOCATIONS OF EXISTING UNDERGROUND UTILITIES ARE SHOWN IN AN APPROXIMATE WAY ONLY AND HAVE NOT BEEN INDEPENDENTLY VERIFIED. THE CONTRACTOR SHALL DETERMINE THE EXACT LOCATION OF ALL EXISTING UTILITIES BEFORE COMMENCING WORK, AND AGREES TO BE FULLY RESPONSIBLE FOR ANY AND ALL DAMAGES WHICH MIGHT BE OCCASIONED BY THE CONTRACTOR'S FAILURE TO EXACTLY LOCATE AND PRESERVE ANY AND ALL UNDERGROUND UTILITIES.

**METRO ENGINEERING SOLUTIONS**  
33900 SCHOOLCRAFT RD  
LIVONIA, MICHIGAN 48150  
PHONE: 734.483.1427 FAX: 734.483.3431  
www.metroes.net

SOUTH ROUTE - WEST OF U.S. 23	
MES JOB# 1043-22	DRAWN - KMM
PLOT SCALE = 1" = 50'	CHECKED - JB
PLAN DATE = 5/26/2023	

ANN ARBOR SPARK  
CORRIDOR FIBER OPTIC BACKBONE PROJECT  
ANN ARBOR  
WASHTENAW COUNTY, MI

PERMITS REQUIRED:

<input checked="" type="checkbox"/> CITY OF ANN ARBOR	<input type="checkbox"/> CITY OF YPSILANTI	<input type="checkbox"/> EGLE
<input type="checkbox"/> WASHTENAW COUNTY	<input type="checkbox"/> YPSILANTI TOWNSHIP	<input type="checkbox"/> RR
<input checked="" type="checkbox"/> WASHTENAW COUNTY DRAIN	<input type="checkbox"/> PITTSFIELD TOWNSHIP	<input checked="" type="checkbox"/> MDOT

SHEET INFORMATION

TOTAL SHEETS	SHEET NO.
42	37

K:\2022\1043 JOB FOLDERS\1043-22-0320\DWG\1043-22-0320_DS.dwg; 8/28/2023 10:38 AM;

K:\2022\1043 JOB FOLDERS\1043-22-0320\DWG\1043-22-0320_DS.dwg; 8/28/2023 10:38 AM;

ROAD CROSSING

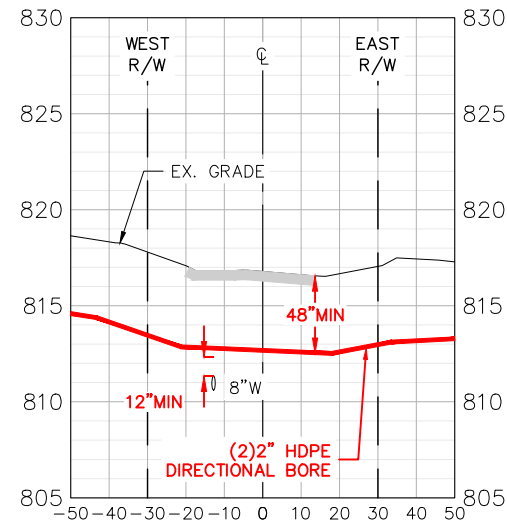

FERNWOOD AVE  
LOOKING NORTH  
1"=50' HORIZONTAL  
1"=10' VERTICAL

ROAD CROSSING

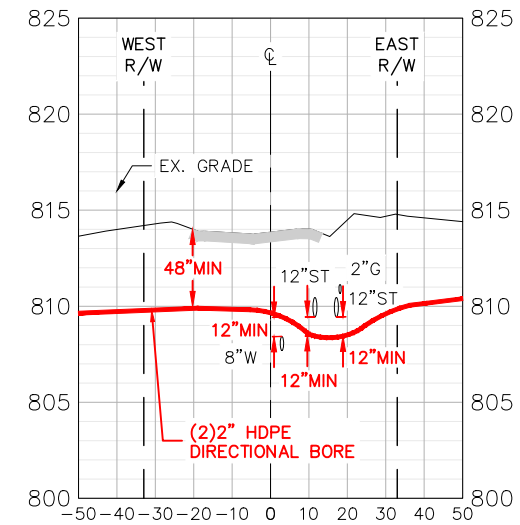

PITTSVIEW DR  
LOOKING NORTH  
1"=50' HORIZONTAL  
1"=10' VERTICAL



Know what's below.  
Call before you dig.

THE LOCATIONS OF EXISTING UNDERGROUND UTILITIES ARE SHOWN IN AN APPROXIMATE WAY ONLY AND HAVE NOT BEEN INDEPENDENTLY VERIFIED. THE CONTRACTOR SHALL DETERMINE THE EXACT LOCATION OF ALL EXISTING UTILITIES BEFORE COMMENCING WORK, AND AGREES TO BE FULLY RESPONSIBLE FOR ANY AND ALL DAMAGES WHICH MIGHT BE OCCASIONED BY THE CONTRACTOR'S FAILURE TO EXACTLY LOCATE AND PRESERVE ANY AND ALL UNDERGROUND UTILITIES.

REVISION		
REV #	DATE	DESCRIPTION
01	7/14/23	REVISED PER CITY OF ANN ARBOR COMMENTS
02	8/24/23	REVISED PER CITY OF ANN ARBOR COMMENTS
03	8/28/23	REVISED PER CITY OF ANN ARBOR COMMENTS
04	9/19/23	REVISED TO AVOID WATER VALVE SHTS 21 & 24

**METRO ENGINEERING SOLUTIONS**  
 33900 SCHOOLCRAFT RD  
 LIVONIA, MICHIGAN 48150  
 PHONE: 734.483.1427 FAX: 734.483.3431  
 www.metroes.net

SOUTH ROUTE - WEST OF U.S. 23	
MES JOB# 1043-22	DRAWN — KMM
PLOT SCALE = 1" = 50'	CHECKED - JB
PLAN DATE = 5/26/2023	

ANN ARBOR SPARK  
 CORRIDOR FIBER OPTIC BACKBONE PROJECT  
 ANN ARBOR  
 WASHTENAW COUNTY, MI

PERMITS REQUIRED:		
<input checked="" type="checkbox"/> CITY OF ANN ARBOR	<input type="checkbox"/> CITY OF YPSILANTI	<input type="checkbox"/> EGLE
<input type="checkbox"/> WASHTENAW COUNTY	<input type="checkbox"/> YPSILANTI TOWNSHIP	<input type="checkbox"/> RR
<input checked="" type="checkbox"/> WASHTENAW COUNTY DRAIN	<input type="checkbox"/> PITTSFIELD TOWNSHIP	<input checked="" type="checkbox"/> MDOT

SHEET INFORMATION	
TOTAL SHEETS	SHEET NO.
42	38



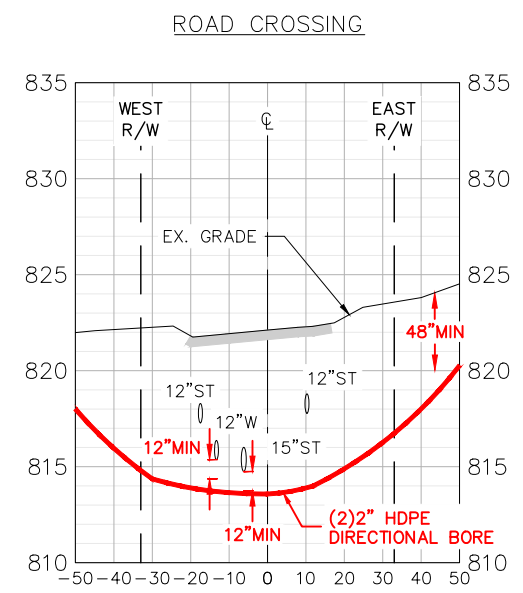
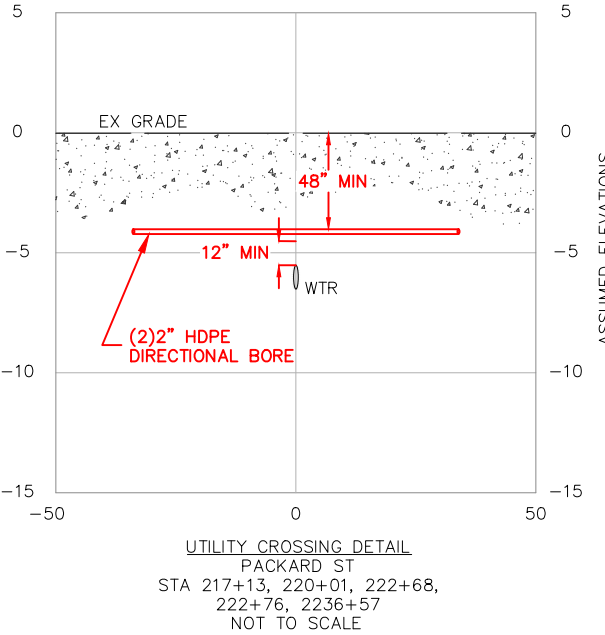
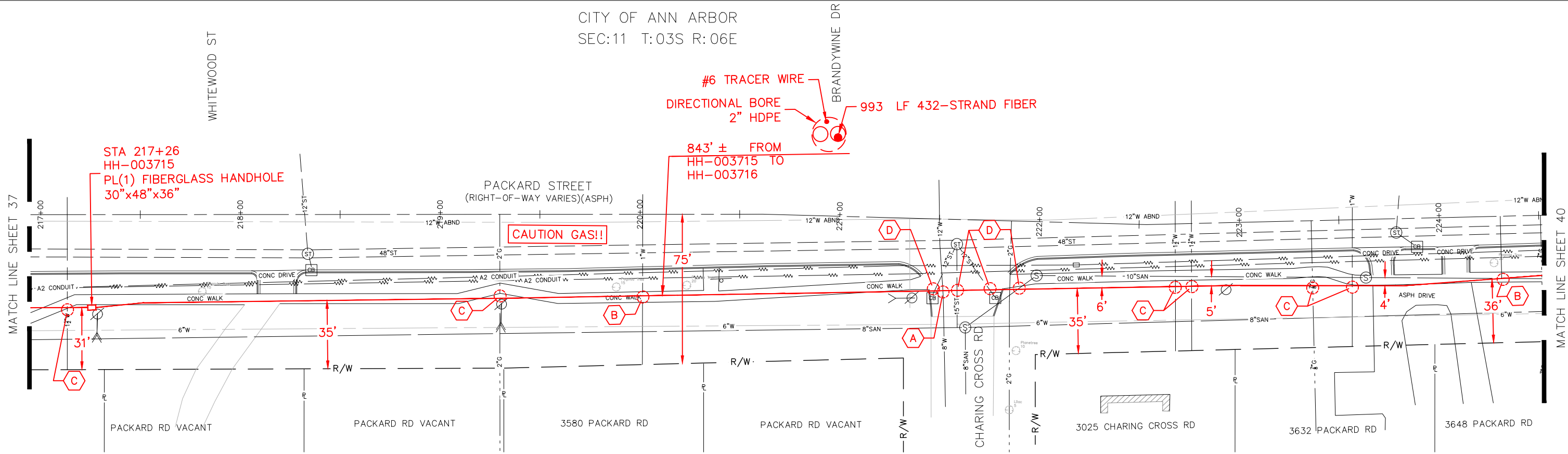

- UTILITY CROSSING/POTHOLE NOTES**
- (A)** POTHOLE. REMOVE & REPLACE (1) SQFT ASPH ROAD.
  - (B)** POTHOLE. REMOVE & REPLACE (1) FLAG CONC WALK.
  - (C)** POTHOLE. REMOVE & REPLACE GREENBELT.
  - (D)** NO POTHOLE NECESSARY. UTILITY DEPTH TO BE VERIFIED AT NEAREST STRUCTURE.

REVISION		
REV #	DATE	DESCRIPTION
01	7/14/23	REVISED PER CITY OF ANN ARBOR COMMENTS
02	8/24/23	REVISED PER CITY OF ANN ARBOR COMMENTS
03	8/28/23	REVISED PER CITY OF ANN ARBOR COMMENTS
04	9/19/23	REVISED TO AVOID WATER VALVE SHTS 21 & 24



THE LOCATIONS OF EXISTING UNDERGROUND UTILITIES ARE SHOWN IN AN APPROXIMATE WAY ONLY AND HAVE NOT BEEN INDEPENDENTLY VERIFIED. THE CONTRACTOR SHALL DETERMINE THE EXACT LOCATION OF ALL EXISTING UTILITIES BEFORE COMMENCING WORK, AND AGREES TO BE FULLY RESPONSIBLE FOR ANY AND ALL DAMAGES WHICH MIGHT BE OCCASIONED BY THE CONTRACTOR'S FAILURE TO EXACTLY LOCATE AND PRESERVE ANY AND ALL UNDERGROUND UTILITIES.

**METRO ENGINEERING SOLUTIONS**  
33900 SCHOOLCRAFT RD  
LIVONIA, MICHIGAN 48150  
PHONE: 734.483.1427 FAX: 734.483.3431  
www.metroes.net

SOUTH ROUTE - WEST OF U.S. 23	
MES JOB# 1043-22	DRAWN - KMM
PLOT SCALE = 1" = 50'	CHECKED - JB
PLAN DATE = 5/26/2023	

ANN ARBOR SPARK  
CORRIDOR FIBER OPTIC BACKBONE PROJECT  
ANN ARBOR  
WASHTENAW COUNTY, MI

PERMITS REQUIRED:

<input checked="" type="checkbox"/> CITY OF ANN ARBOR	<input type="checkbox"/> CITY OF YPSILANTI	<input type="checkbox"/> EGLE
<input type="checkbox"/> WASHTENAW COUNTY	<input type="checkbox"/> YPSILANTI TOWNSHIP	<input type="checkbox"/> RR
<input checked="" type="checkbox"/> WASHTENAW COUNTY DRAIN	<input type="checkbox"/> PITTSFIELD TOWNSHIP	<input checked="" type="checkbox"/> MDOT

SHEET INFORMATION

TOTAL SHEETS	SHEET NO.
42	39

K:\2022\1043 JOB FOLDERS\1043-22-0320\DWG\1043-22-0320_DS.dwg; 8/28/2023 10:38 AM;

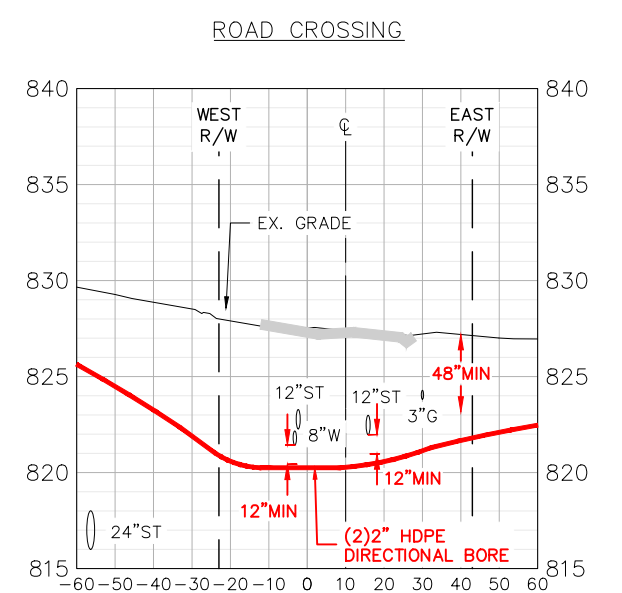
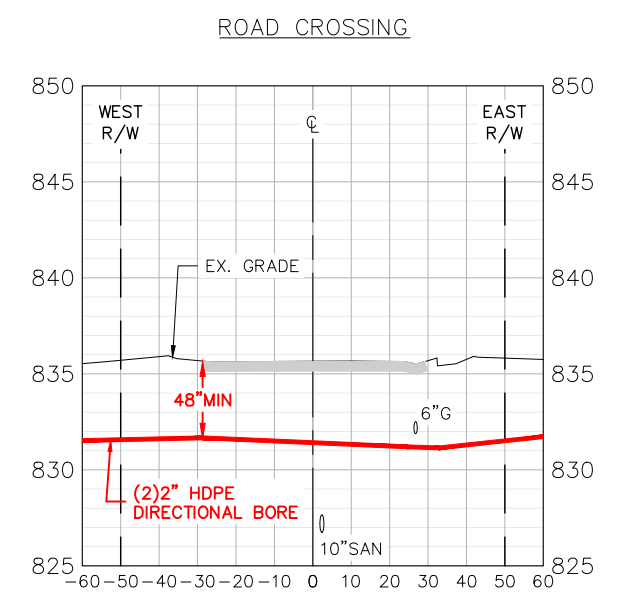
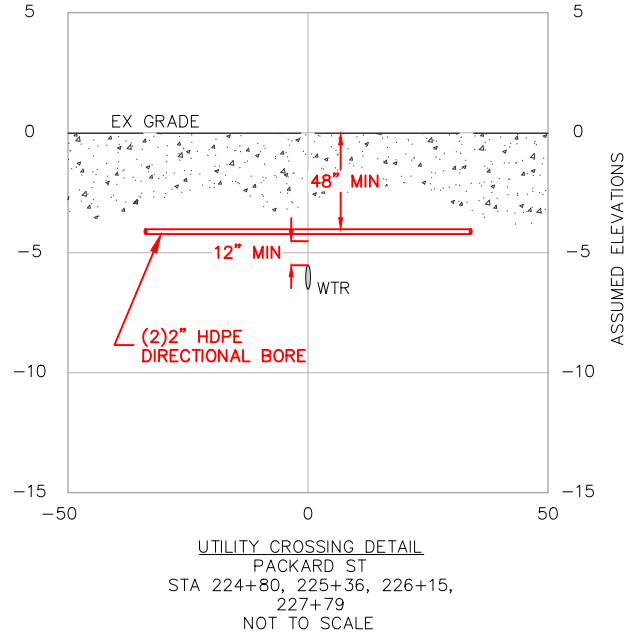
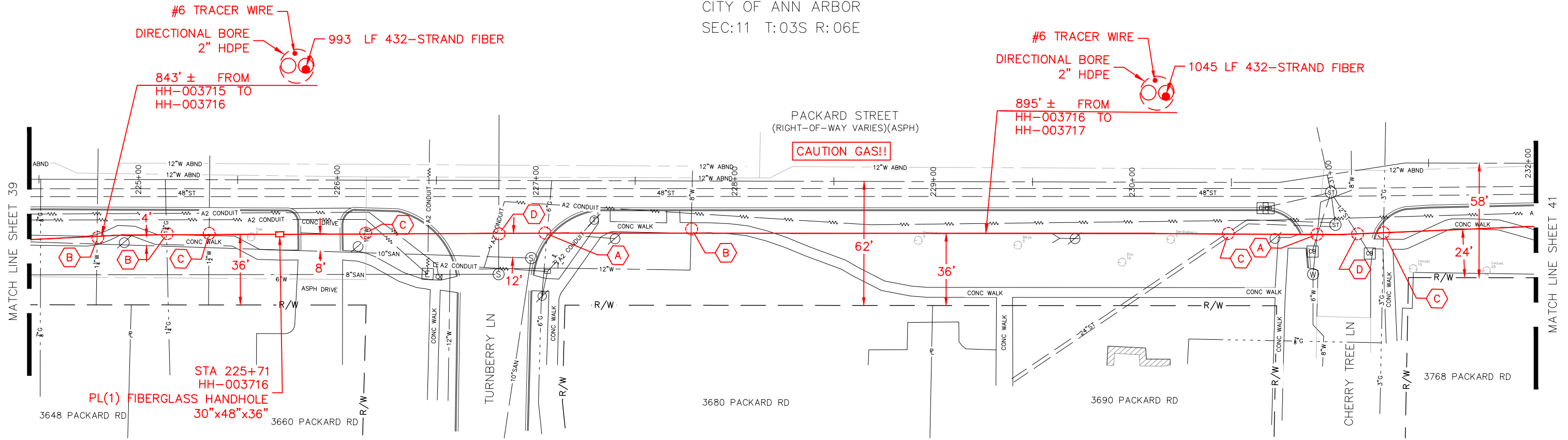

- UTILITY CROSSING/POTHOLE NOTES**
- A** POTHOLE. REMOVE & REPLACE (1) SQFT ASPH ROAD.
  - B** POTHOLE. REMOVE & REPLACE (1) FLAG CONC WALK.
  - C** POTHOLE. REMOVE & REPLACE GREENBELT.
  - D** NO POTHOLE NECESSARY. UTILITY DEPTH TO BE VERIFIED AT NEAREST STRUCTURE.

REVISION		
REV #	DATE	DESCRIPTION
01	7/14/23	REVISED PER CITY OF ANN ARBOR COMMENTS
02	8/24/23	REVISED PER CITY OF ANN ARBOR COMMENTS
03	8/28/23	REVISED PER CITY OF ANN ARBOR COMMENTS
04	9/19/23	REVISED TO AVOID WATER VALVE SHTS 21 & 24



THE LOCATIONS OF EXISTING UNDERGROUND UTILITIES ARE SHOWN IN AN APPROXIMATE WAY ONLY AND HAVE NOT BEEN INDEPENDENTLY VERIFIED. THE CONTRACTOR SHALL DETERMINE THE EXACT LOCATION OF ALL EXISTING UTILITIES BEFORE COMMENCING WORK, AND AGREES TO BE FULLY RESPONSIBLE FOR ANY AND ALL DAMAGES WHICH MIGHT BE OCCASIONED BY THE CONTRACTOR'S FAILURE TO EXACTLY LOCATE AND PRESERVE ANY AND ALL UNDERGROUND UTILITIES.

**METRO ENGINEERING SOLUTIONS**  
33900 SCHOOLCRAFT RD  
LIVONIA, MICHIGAN 48150  
PHONE: 734.483.1427 FAX: 734.483.3431  
www.metroes.net

SOUTH ROUTE - WEST OF U.S. 23	
MES JOB# 1043-22	DRAWN - KMM
PLOT SCALE = 1" = 50'	CHECKED - JB
PLAN DATE = 5/26/2023	

ANN ARBOR SPARK  
CORRIDOR FIBER OPTIC BACKBONE PROJECT  
ANN ARBOR  
WASHTENAW COUNTY, MI

PERMITS REQUIRED:

<input checked="" type="checkbox"/> CITY OF ANN ARBOR	<input type="checkbox"/> CITY OF YPSILANTI	<input type="checkbox"/> EGLE
<input type="checkbox"/> WASHTENAW COUNTY	<input type="checkbox"/> YPSILANTI TOWNSHIP	<input type="checkbox"/> RR
<input checked="" type="checkbox"/> WASHTENAW COUNTY DRAIN	<input type="checkbox"/> PITTSFIELD TOWNSHIP	<input checked="" type="checkbox"/> MDOT

SHEET INFORMATION

TOTAL SHEETS	SHEET NO.
42	40

K:\2022\1043 JOB FOLDERS\1043-22-0320\DWG\1043-22-0320_DS.dwg; 8/28/2023 10:38 AM;

K:\2022\1043 JOB FOLDERS\1043-22-0320\DWG\1043-22-0320_DS.dwg; 8/28/2023 10:38 AM;

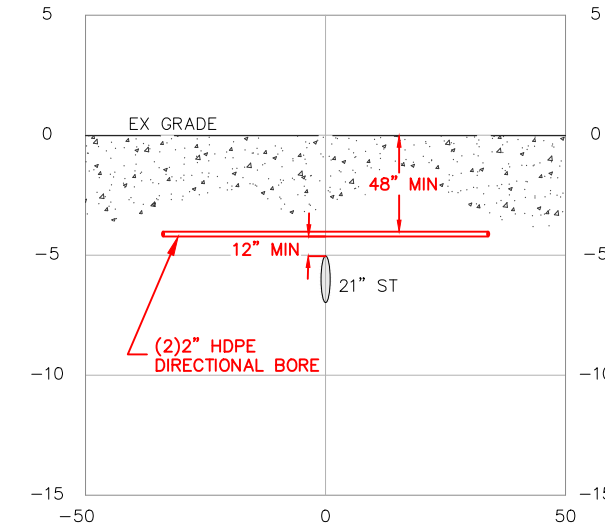
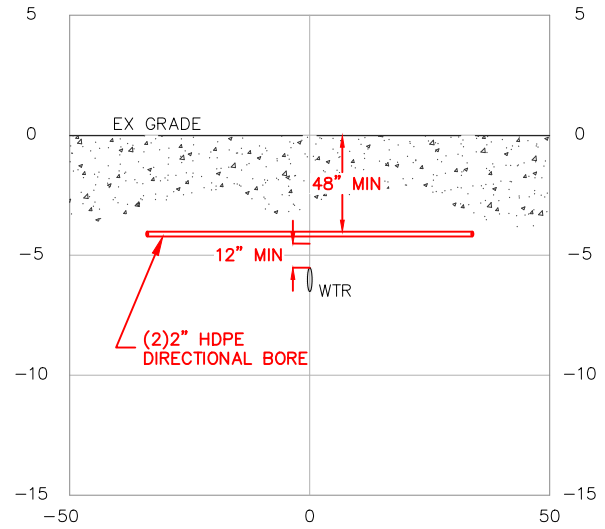
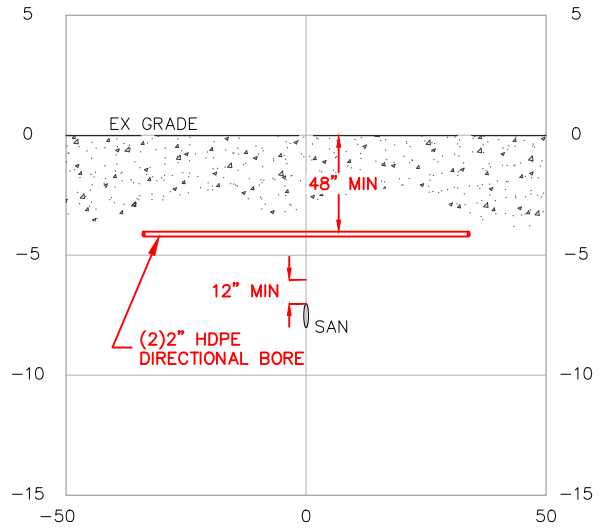
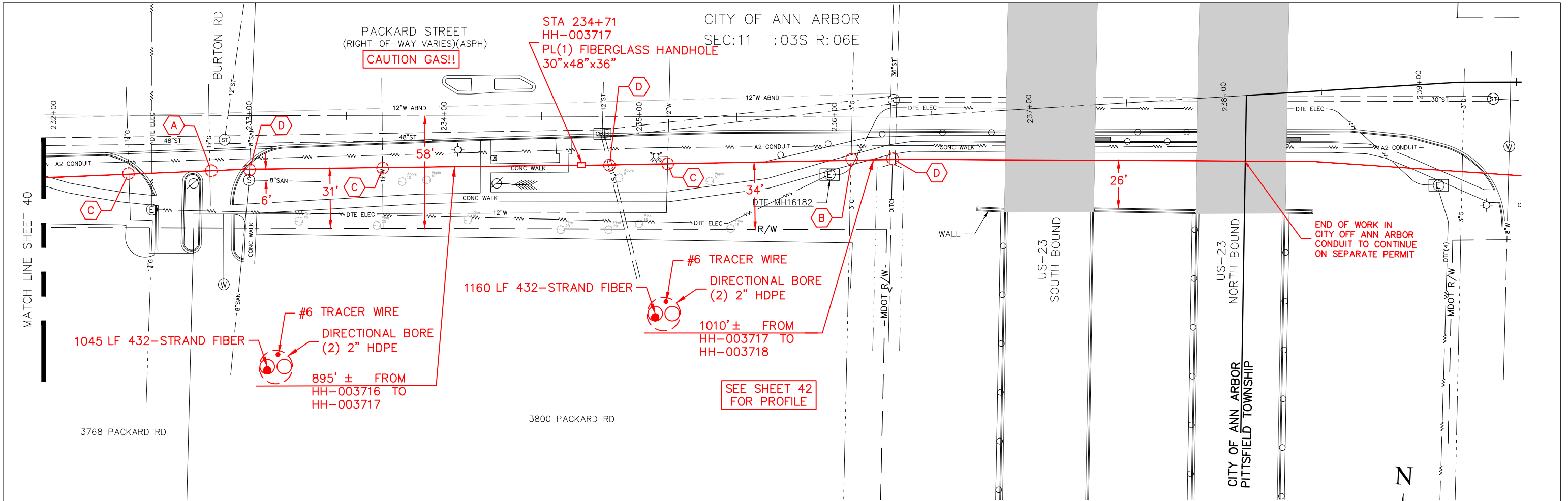

- UTILITY CROSSING/POTHOLE NOTES**
- A** POTHOLE. REMOVE & REPLACE (1) SQFT ASPH ROAD.
  - B** POTHOLE. REMOVE & REPLACE (1) FLAG CONC WALK.
  - C** POTHOLE. REMOVE & REPLACE GREENBELT.
  - D** NO POTHOLE NECESSARY. UTILITY DEPTH TO BE VERIFIED AT NEAREST STRUCTURE.

REVISION		
REV #	DATE	DESCRIPTION
01	7/14/23	REVISED PER CITY OF ANN ARBOR COMMENTS
02	8/24/23	REVISED PER CITY OF ANN ARBOR COMMENTS
03	8/28/23	REVISED PER CITY OF ANN ARBOR COMMENTS
04	9/19/23	REVISED TO AVOID WATER VALVE SHTS 21 & 24



THE LOCATIONS OF EXISTING UNDERGROUND UTILITIES ARE SHOWN IN AN APPROXIMATE WAY ONLY AND HAVE NOT BEEN INDEPENDENTLY VERIFIED. THE CONTRACTOR SHALL DETERMINE THE EXACT LOCATION OF ALL EXISTING UTILITIES BEFORE COMMENCING WORK, AND AGREES TO BE FULLY RESPONSIBLE FOR ANY AND ALL DAMAGES WHICH MIGHT BE OCCASIONED BY THE CONTRACTOR'S FAILURE TO EXACTLY LOCATE AND PRESERVE ANY AND ALL UNDERGROUND UTILITIES.

**METRO ENGINEERING SOLUTIONS**  
 33900 SCHOOLCRAFT RD  
 LIVONIA, MICHIGAN 48150  
 PHONE: 734.483.1427 FAX: 734.483.3431  
 www.metroes.net

SOUTH ROUTE - WEST OF U.S. 23	
MES JOB# 1043-22	DRAWN - KMM
PLOT SCALE = 1" = 50'	CHECKED - JB
PLAN DATE = 5/26/2023	

ANN ARBOR SPARK  
 CORRIDOR FIBER OPTIC BACKBONE PROJECT  
 ANN ARBOR  
 WASHTENAW COUNTY, MI

PERMITS REQUIRED:

<input checked="" type="checkbox"/> CITY OF ANN ARBOR	<input type="checkbox"/> CITY OF YPSILANTI	<input type="checkbox"/> EGLE
<input type="checkbox"/> WASHTENAW COUNTY	<input type="checkbox"/> YPSILANTI TOWNSHIP	<input type="checkbox"/> RR
<input checked="" type="checkbox"/> WASHTENAW COUNTY DRAIN	<input type="checkbox"/> PITTSFIELD TOWNSHIP	<input checked="" type="checkbox"/> MDOT

SHEET INFORMATION

TOTAL SHEETS	SHEET NO.
42	41

K:\2022\1043 JOB FOLDERS\1043-22-0320\DWG\1043-22-0320_DS.dwg; 8/28/2023 10:38 AM;

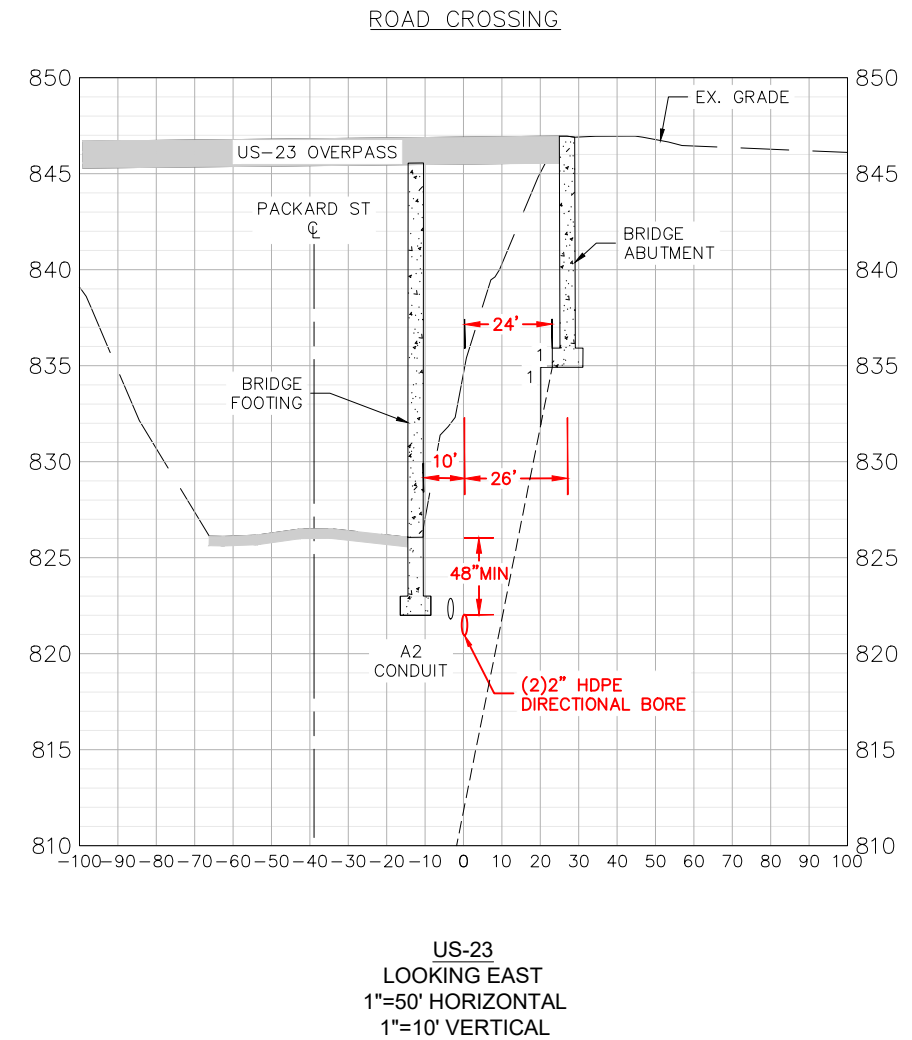
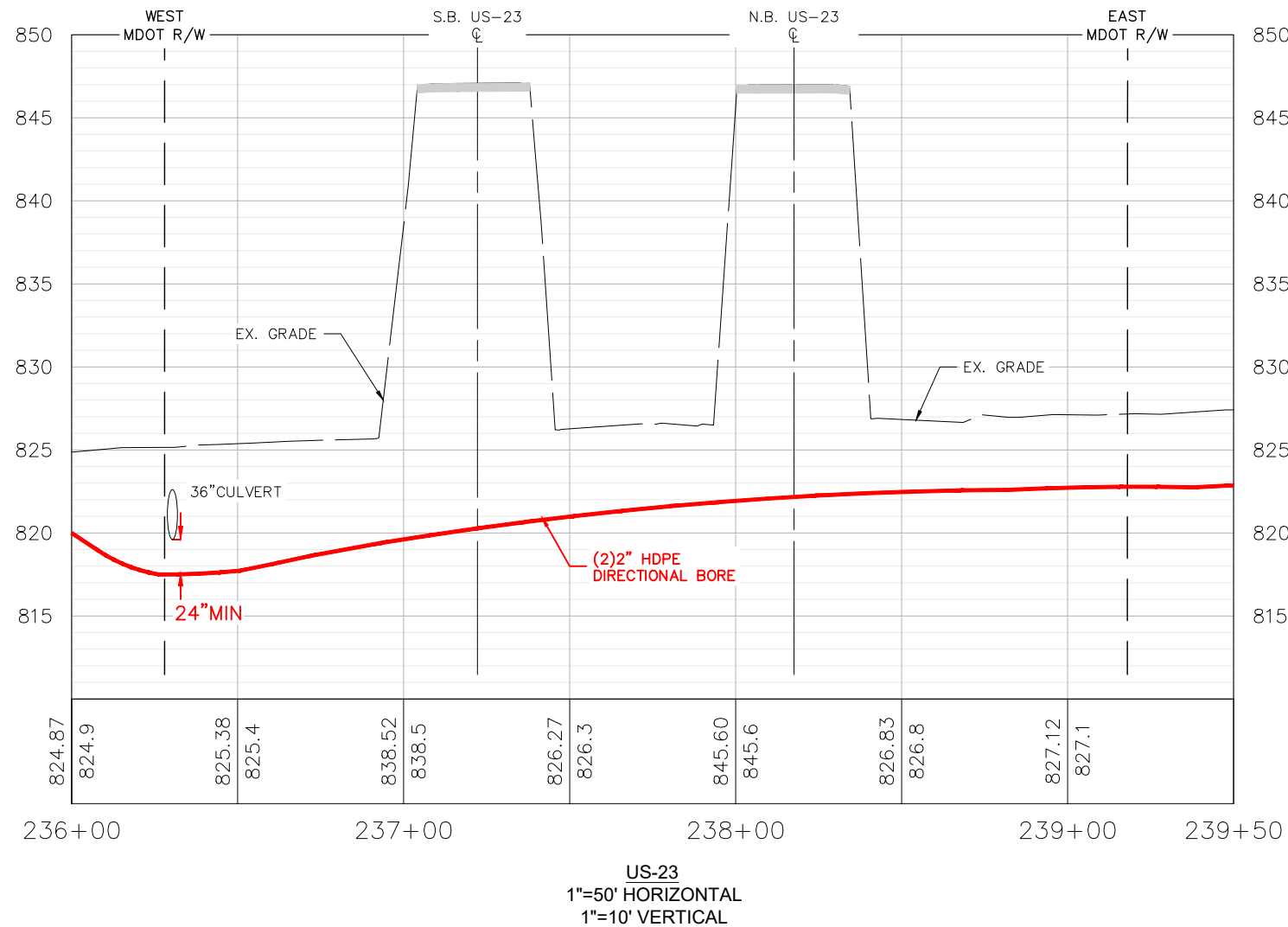

Know what's below.  
Call before you dig.

THE LOCATIONS OF EXISTING UNDERGROUND UTILITIES ARE SHOWN IN AN APPROXIMATE WAY ONLY AND HAVE NOT BEEN INDEPENDENTLY VERIFIED. THE CONTRACTOR SHALL DETERMINE THE EXACT LOCATION OF ALL EXISTING UTILITIES BEFORE COMMENCING WORK, AND AGREES TO BE FULLY RESPONSIBLE FOR ANY AND ALL DAMAGES WHICH MIGHT BE OCCASIONED BY THE CONTRACTOR'S FAILURE TO EXACTLY LOCATE AND PRESERVE ANY AND ALL UNDERGROUND UTILITIES.

**METRO ENGINEERING SOLUTIONS**  
 33900 SCHOOLCRAFT RD  
 LIVONIA, MICHIGAN 48150  
 PHONE: 734.483.1427 FAX: 734.483.3431  
 www.metroes.net

SOUTH ROUTE - WEST OF U.S. 23	
MES JOB# 1043-22	DRAWN — KMM
PLOT SCALE = 1" = 50'	CHECKED - JB
PLAN DATE = 5/26/2023	

ANN ARBOR SPARK  
 CORRIDOR FIBER OPTIC BACKBONE PROJECT  
 ANN ARBOR  
 WASHTENAW COUNTY, MI

PERMITS REQUIRED:		
<input checked="" type="checkbox"/> CITY OF ANN ARBOR	<input type="checkbox"/> CITY OF YPSILANTI	<input type="checkbox"/> EGLE
<input type="checkbox"/> WASHTENAW COUNTY	<input type="checkbox"/> YPSILANTI TOWNSHIP	<input type="checkbox"/> RR
<input checked="" type="checkbox"/> WASHTENAW COUNTY DRAIN	<input type="checkbox"/> PITTSFIELD TOWNSHIP	<input checked="" type="checkbox"/> MDOT

SHEET INFORMATION	
TOTAL SHEETS	SHEET NO.
42	42

REVISION		
REV #	DATE	DESCRIPTION
01	7/14/23	REVISED PER CITY OF ANN ARBOR COMMENTS
02	8/24/23	REVISED PER CITY OF ANN ARBOR COMMENTS
03	8/28/23	REVISED PER CITY OF ANN ARBOR COMMENTS
04	9/19/23	REVISED TO AVOID WATER VALVE SHTS 21 & 24

## SPARK PERMIT SUMMARY

### City of Ann Arbor

- ROW23-0394 / Northwest segment.
- ROW23-0496 / Southwest segment.

### MDOT

- 81072-094192-23-052423 / Northeast & northwest segments – Washtenaw Ave (BL-94)
- 81074-094849-23-062523 / Southwest segment – US23 crossing.
- 81083-094872-23-062523 / Southeast segment – N Huron St (M-17)

### Washtenaw County Water Resource Commission

- WO#99554 / Northwest segment – Mallets Creek crossing sheet 26.
- WO#9961 / Northeast segment – Owen Drain crossing sheet 28.
- WO#9962 / Northeast segment – Ypsi Township #2 Drain crossing sheet 21.
- WO#9963 / Northeast segment – Owen Relief Drain crossing sheet 26.
- WO#9964 / Northeast segment – Swift Run Drain crossing sheet 06.
- WO#10021 / Northeast segment – Oak Park-Washington Hts. Drain crossing sheet 15.
- WO#10022 / Northeast segment – Owen Drain crossing sheet 28.
- WO#10040 / Southwest segment – Mallets Creek crossing sheet 32.
- WO#10041 / Southwest segment – Swift Run Drain crossing sheet 37.
- WO#10033 / Southeast segment – Owen Drain crossing sheet 26.
- WO#10034 / Southeast segment – Ypsi Twp #01 Consolidated Drain crossing sheet 18.
- WO#10159 / Southeast segment – Packard Branch of Paint Creek crossing sheet 13.
- WO#10160 / Southeast segment – Upper Paint Creek crossing sheet 15.
- WO#10162 / Southeast segment – Ypsi Twp #01 Consolidated Drain crossing sheet 16.
- WO#10638 / Southeast segment – Packard Branch of Paint Creek encroachment sheets 11-13

### Washtenaw County Road Commission

- 2023-724 / Southeast segment

### Pittsfield Township

- Northeast segment / email approval received 7/5/2023.
- Southeast segment / email approval received 9/19/2023.

### City of Ypsilanti

- R23-10060153 / Northeast segment
- R23-10060153 / Southeast segment  
*Separate permits issued under same permit #.

### EGLE

- HPR-V4CS-XE88W / Letter received stating no permit required.

SPARK Permits by Segment

Northwest Segment

- City of Ann Arbor - ROW23-0394.
- MDOT - 81072-094192-23-052423
- Washtenaw County Water Resource Commission - WO#99554

Northeast Segment

- MDOT - 81072-094192-23-052423
- Washtenaw County Water Resource Commission
  - WO#9961
  - WO#9962
  - WO#9963
  - WO#9964
  - WO#10021
  - WO#10022
- Pittsfield Township – email approval.
- City of Ypsilanti – R23-10060153 / Washtenaw, W Cross, Huron.

Southwest Segment

- City of Ann Arbor - ROW23-0496
- MDOT - 81074-094849-23-062523
- Washtenaw County Water Resource Commission
  - WO#10040
  - WO#10041

Southeast Segment

- Washtenaw County Road Commission - 2023-724
- Washtenaw County Water Resource Commission
  - WO#10033
  - WO#10034
  - WO#10159
  - WO#10160
  - WO#10162
  - WO#10638
- Pittsfield Township -email approval
- City of Ypsilanti – R23-10060153 / Cross St to Mansfield to S Congress to Michigan Ave & Huron St (M-17)
- MDOT - 81083-094872-23-062523