

CITY OF ANN ARBOR
INVITATION TO BID



**WWTP 2015 ACCESS BRIDGE REPAIR
PROJECT**

ITB No. 4390

Due Date: July 1, 2015 by 2:00 p.m.

Public Services Area

Issued By:

City of Ann Arbor
Procurement Unit
301 E. Huron Street
Ann Arbor, MI 48104

TABLE OF CONTENTS

TABLE OF CONTENTS.....	TC-1
ADVERTISEMENT.....	AD-1 to 2
NOTICE OF PRE-BID CONFERENCE.....	NP-1
INSTRUCTIONS TO BIDDERS.....	IB-1 to 5
INVITATION TO BID.....	ITB-1 to 3
BID FORMS.....	BF-1 to 6
CONTRACT.....	C-1 to 3
BOND FORMS.....	B-1 to 2
GENERAL CONDITIONS.....	GC-1 to 18
STANDARD SPECIFICATIONS.....	SS-1
DETAILED SPECIFICATION.....	DS-1 to 40
APPENDIX.....	APDX-1 to 13

ATTACHMENTS

City of Ann Arbor Living Wage Forms

City of Ann Arbor Vendor Conflict of Interest Disclosure Form

City of Ann Arbor Non-Discrimination Ordinance Notice and Declaration Form

**ADVERTISEMENT
FOR
WWTP 2015 ACCESS BRIDGE REPAIR PROJECT
CITY OF ANN ARBOR**

BID NO. ITB No. 4390

Sealed Bids will be received by the City of Ann Arbor Procurement Unit, 301 East Huron Street, c/o Customer Service, 1st Floor, Larcom City Hall, on or before **2:00 p.m., Wednesday, July 1, 2015 (Local Time)** for the construction of the **WWTP 2015 Access Bridge Repair Project**. Bids will be publically opened and read aloud at this time.

A pre-bid conference will be held on Wednesday, June 10, 2015 at 9:30 a.m. at the Ann Arbor Wastewater Treatment Plant, Storage Trailer, 49 Old Dixboro Road, Ann Arbor, Michigan 48105. Attendance is **mandatory**.

Work to be done includes removal of timber debris upstream of pier, removing and replacing pier diaphragms, partial cleaning and coating of structural steel, chipping and patching of substructure, crack injection of substructure, placing scour countermeasures, cleaning expansion joint, brush and tree removal, and slope restoration.

Bid documents, specifications, and addenda, with the exception of the Plans, shall be downloaded by bidders at either of the following websites: Michigan Inter-governmental Trade Network (MITN) www.mitn.info or City of Ann Arbor Purchasing website: www.A2gov.org. It is the bidder's responsibility to verify they have obtained all information before submitting a bid.

Each Bid shall be accompanied by a certified check, or Bid Bond by a surety authorized to transact business in Michigan, in the amount of 5% of the total of the bid price. A Bid, once submitted, becomes the property of the City. In the sole discretion of the City, the City reserves the right to allow a bidder to reclaim submitted documents provided the documents are requested and retrieved no later than 48 hours prior to the scheduled bid opening.

The successful Bidder will be required to furnish satisfactory performance and labor and material bonds in the amount of 100% of the bid price. The form of the Performance Bond and labor and materials bond is attached hereto. The successful Bidder will be required to provide satisfactory insurance coverage, including evidence of endorsement prior to issuance of a Notice to Proceed.

Precondition for entering into a Contract with the City of Ann Arbor is compliance with the wage and employment requirements of Chapter 14 of Title I of the Code of City of Ann Arbor and Chapter 112 of Title IX of the Code of the City of Ann Arbor. Employees whose wage level are subject to federal or state prevailing wage law must be paid in accordance with their U.S. Department of Labor wage rate classification (see www.wdol.gov) The wage determination(s) current on the date 10 days before bids are due shall apply to this contract.

Employees whose wage level are not otherwise subject to federal or state prevailing wage law, must be paid a living wage in accordance with Chapter 112 of the City Code. The successful Bidder may also be required to comply with Chapter 23 of Title I of the Code of the City of Ann

Arbor. Further information is outlined in the Contract Documents. All bidders are required to complete and submit the City of Ann Arbor Conflict of Interest Disclosure Form with the bid.

After the time of opening, no Bid may be withdrawn for a period of seventy-five **(75)** days.

Technical questions regarding this project may be submitted in writing to Talia Belill at tbelill@dlz.com. Questions by telephone call are prohibited. The deadline for questions shall be Tuesday, June 23, 2015 @ 3:00 p.m. Questions will not be accepted after this time.

The City reserves the right to accept any Bid, to reject any or all Bids, to waive irregularities and/or informalities in any Bid, and to make the award in any manner the City believes to be in its best interest.

Any further information on bid documents may be obtained from the Procurement Office, (734) 794-6500.

CITY OF ANN ARBOR PROCUREMENT UNIT

NOTICE OF PRE-BID CONFERENCE

A **mandatory** pre-bid conference for this project will be held on Wednesday, June 10, 2015 @ 9:30 a.m. at the Ann Arbor Wastewater Treatment Plant Storage Trailer, 49 Old Dixboro Road, Ann Arbor, Michigan 48105. **Failure to attend the meeting and sign the ITB No. 4390 sign-in sheet at the pre-bid meeting will automatically disqualify a bidder from submitting a valid bid.** Any bid submitted by a party not attending and signing the roster at the pre-bid meeting will not be opened or considered. Administrative and technical questions regarding this project will be answered at this time. The pre-bid meeting is for information only. Any answers furnished will not be official until verified in writing by the Financial Service Area, Procurement Unit. Answers that change or substantially clarify the bid will be affirmed in an addendum.

INSTRUCTIONS TO BIDDERS

General

Work to be done under this Contract is generally described through the detailed specifications and must be completed fully in accordance with the contract documents. All work to be done under this Contract is located in or near the City of Ann Arbor.

Any Bid which does not conform fully to these instructions may be rejected.

Preparation of Bids

Bids should be prepared providing a straight-forward, concise description of the Bidder's ability to meet the requirements of the ITB. Bids shall be written in ink or typewritten. No erasures are permitted. Mistakes may be crossed out and corrected and must be initialed and dated in ink by the person signing the Bid.

Bids must be submitted on the "Bid Forms" provided with each blank properly filled in. If forms are not fully completed it may disqualify the bid. No alternative bid will be considered unless alternative bids are specifically requested. If alternatives are requested, any deviation from the specification must be fully described, in detail on the "Alternate" section of Bid form.

Each person signing the Bid certifies that he/she is the person in the Bidder's firm/organization responsible for the decision as to the fees being offered in the Bid and has not and will not participated in any action contrary to the terms of this provision.

Questions or Clarification on ITB Specifications

All questions regarding this ITB shall be submitted via email. Emailed questions and inquires will be accepted from any and all prospective Bidders in accordance with the terms and conditions of the ITB.

All questions shall be due on or before **Tuesday, June 23, 2015 by 3:00 p.m.** and should be addressed as follows:

Specification/Scope of Work questions emailed to tbelill@dlz.com
Bid Process and HR Compliance questions emailed to cspencer@a2gov.org

Any error, omissions or discrepancies in the specification discovered by a prospective contractor and/or service provider shall be brought to the attention of Mike Amicangelo at mamicangelo@a2gov.org after discovery as soon as possible. Further, the contractor and/or service provide shall not be allowed to take advantage of errors, omissions or discrepancies in the specifications.

Addenda

If it becomes necessary to revise any part of the ITB, notice of the Addendum will be posted to Michigan Inter-governmental Trade Network (MITN) www.mitn.info and/or City of Ann Arbor web site www.A2gov.org for all parties to download.

Each Bidder must in its Bid, to avoid any miscommunications, acknowledge all addenda which it has received, but the failure of a Bidder to receive, or acknowledge receipt of; any addenda shall not relieve the Bidder of the responsibility for complying with the terms thereof.

The City will not be bound by oral responses to inquiries or written responses other than written addenda.

Bid Submission

All Bids are due and must be delivered to the City of Ann Arbor Procurement Unit on or before **2:00 p.m., Wednesday, July 1, 2015.** Bids submitted late or via oral, telephonic, telegraphic, electronic mail or facsimile **will not** be considered or accepted.

Each Bidder must submit one (1) original Bid and one (1) Bid copies in a sealed envelope clearly marked: **ITB No. 4390, WWTP 2015 Access Bridge Repair Project.**

Bids must be addressed and delivered to:

City of Ann Arbor
Procurement Unit,
c/o Customer Services, 1st Floor
301 East Huron Street
P.O. Box 8647
Ann Arbor, MI 48107

All Bids received on or before the Due Date will be publicly opened and recorded immediately. No immediate decisions are rendered.

Hand delivered bids will be date/time stamped/signed by the Procurement Unit at the address above in order to be considered. Normal business hours are 9:00 a.m. to 3:00 p.m. Monday through Friday, excluding Holidays. The City will not be liable to any Bidder for any unforeseen circumstances, delivery or postal delays. Postmarking to the Due Date will not substitute for receipt of the Bid. Each Bidder is responsible for submission of their Bid.

Additional time for submission of bids past the stated due date and time will not be granted to a single Bidder; however, additional time may be granted to all Bidders when the City determines in its sole discretion that circumstances warrant it.

Award

The City intends to award a Contract(s) to the lowest responsible Bidder(s). On multi-divisional contracts, separate divisions may be awarded to separate Bidders. The City may also utilize alternatives offered in the Bid Forms, if any, to determine the lowest responsible Bidder on each division, and award multiple divisions to a single Bidder, so that the lowest total cost is achieved for the City. For unit price bids, the Contract will be awarded based upon the unit prices and the lump sum prices stated by the bidder for the work items specified in the bid documents, with consideration given to any alternates selected by the City. If the City determines that the unit price for any item is materially different for the work item bid than either other bidders or the general market, the City, in its sole discretion, in addition to any other right it may have, may reject the bid as not responsible or non-conforming.

The acceptability of major subcontractors will be considered in determining if a Bidder is responsible. In comparing Bids, the City will give consideration to alternate Bids for items listed in the bid forms. All key staff and subcontractors are subject to the approval by the City.

Official Documents

The City of Ann Arbor officially distributes bid documents from the Procurement Unit or through the Michigan Intergovernmental Trade Network (MITN). Copies of the bid documents obtained

from any other source are not Official copies. Addenda and other bid information will only be posted to these official distribution sites. If you obtained City of Ann Arbor Bid documents from other sources, it is recommended that you register on www.MITN.info and obtain an official Bid.

Bid Security

Each bid must be accompanied by a certified check, or Bid Bond by a surety licensed and authorized to do business within the State of Michigan, in the amount of 5% of the total of the bid price.

Withdrawal of Bids

After the time of opening, no Bid may be withdrawn for the period of seventy-five (75) days specified in the Advertisement.

Contract Time

Time is of the essence in the performance of the work under this Contract. The available time for work under this Contract is 70 calendar days from issuance of the Notice to Proceed and as indicated on page DS-1, Project Schedule of the Detailed Specifications and in Article III of the Contract. If these time requirements cannot be met, the Bidder must stipulate on Bid Form Section 3 - Time Alternate its schedule for performance of the work. Consideration will be given to time in evaluating bids.

Liquidated Damages

A liquidated damages clause, as given on page C-2, Article III of the Contract, provides that the Contractor shall pay the City as liquidated damages, and not as a penalty, a sum equal to \$600 per calendar day for each and every day that the Contractor may be in default of completion of the specified work, within the time(s) stated in the Contract, or written extensions.

Liquidated damages clauses, as given in the General Conditions, provide further that the City shall be entitled to impose and recover liquidated damages for breach of the obligations under Chapter 112 of the City Code.

The liquidated damages are for the non-quantifiable aspects of any of the previously identified events and do not cover actual damages that can be shown or quantified nor are they intended to preclude recovery of actual damages in addition to the recovery of liquidated damages.

Human Rights Information

All contractors proposing to do business with the City shall satisfy the contract compliance administrative policy adopted by the City Administrator in accordance with the Section 9:158 of the Ann Arbor City Code. Breach of the obligation not to discriminate as outlined in Section 5, beginning at page GC-3 shall be a material breach of the contract. Contractors are required to post a copy of Ann Arbor's Non-Discrimination Ordinance attached at all work locations where its employees provide services under a contract with the City.

Wage Requirements

Section 4, beginning at page GC-2, outlines the requirements for payment of prevailing wages

or of a “living wage” to employees providing service to the City under this contract. The successful bidder must comply with all applicable requirements and provide documentary proof of compliance when requested.

For laborers whose wage level are subject to federal or state prevailing wage law the appropriate Davis-Bacon wage rate classification is identified based upon the work including within this contract. **The wage determination(s) current on the date 10 days before bids are due shall apply to this contract.** The U.S. Department of Labor (DOL) has provided explanations to assist with classification in the following resource link: www.wdol.gov

Conflict Of Interest Disclosure

The City of Ann Arbor Purchasing Policy requires that prospective Vendors complete a Conflict of Interest Disclosure form. A contract may not be awarded to the selected Vendor unless and until the Procurement Unit and the City Administrator have reviewed the Disclosure form and determined that no conflict exists under applicable federal, state, or local law or administrative regulation. Not every relationship or situation disclosed on the Disclosure Form may be a disqualifying conflict. Depending on applicable law and regulations, some contracts may awarded on the recommendation of the City Administrator after full disclosure, where such action is allowed by law, if demonstrated competitive pricing exists and/or it is determined the award is in the best interest of the City. A copy of the Vendor Conflict of Interest Disclosure Form is attached.

Major Subcontractors

The Bidder shall identify on Bid Form Section 4 each major subcontractor it expects to engage for this Contract if the work to be subcontracted is 15% or more of the bid sum or over \$50,000, whichever is less. The Bidder also shall identify the work to be subcontracted to each major subcontractor. The Bidder shall not change or replace a subcontractor without approval by the City.

Debarment

Submission of a Bid in response to this ITB is certification that the Bidder is not currently debarred, suspended, proposed for debarment, and declared ineligible or voluntarily excluded from participation in this transaction by any State or Federal departments or agency. Submission is also agreement that the City will be notified of any changes in this status.

Disclosures

After bids are opened, all information in a submitter’s bid is subjected to disclosure under the provisions of Michigan Public Act No. 442 of 1976, as amended (MCL 15.231 et seq.) known as the “Freedom of Information Act.” The Freedom of Information Act also provides for the complete disclosure of contracts and attachments thereto except where specifically exempted.

Bid Protest

All Bid protests must be in writing and filed with the Purchasing Agent within five (5) business days of the award action. The bidder must clearly state the reasons for the protest. If a bidder contacts a City Service Area/Unit and indicates a desire to protest an award, the Service Area/Unit shall refer the bidder to the Purchasing Agent. The Purchasing Agent will provide the bidder with the appropriate instructions for filing the protest. The protest shall be reviewed by the City Administrator or designee whose decision shall be final.

Cost Liability

The City of Ann Arbor assumes no responsibility or liability for costs incurred by the Bidder prior to the execution of a contract with the City. By submitting a bid, a bidder agrees to bear all costs incurred or related to the preparation, submission and selection process for the bid.

Reservation of Rights

The City of Ann Arbor reserves the right to accept any bid or alternative bid proposed in whole or in part, to reject any or all bids or alternatives bids in whole or in part and to waive irregularity and/or informalities in any bid and to make the award in any manner deemed in the best interest of the City.

INVITATION TO BID

City of Ann Arbor
Guy C. Larcom Municipal Building
Ann Arbor, Michigan 48107

Ladies and Gentlemen:

The undersigned, as Bidder, declares that this Bid is made in good faith, without fraud or collusion with any person or persons bidding on the same Contract; that this Bidder has carefully read and examined the bid documents, including Advertisement, City Nondiscrimination and Wage requirements, Vendor Conflict of Interest Form, Notice of Pre-Bid Conference, Instructions to Bidders, Bid, Bid Forms, Contract, Bond Forms, General Conditions, Standard Specifications, Detailed Specifications, all Addenda, and the Plans (if applicable) and understands them. The Bidder declares that it conducted a full investigation at the site and of the work proposed and is fully informed as to the nature of the work and the conditions relating to the work's performance. The Bidder also declares that it has extensive experience in successfully completing projects similar to this one.

The Bidder acknowledges that it has not received or relied upon any representations or warrants of any nature whatsoever from the City of Ann Arbor, its agents or employees, and that this Bid is based solely upon the Bidder's own independent business judgment.

The undersigned proposes to perform all work shown on the plans or described in the bid documents, including any addenda issued, and to furnish all necessary machinery, tools, apparatus, and other means of construction to do all the work, furnish all the materials, and complete the work in strict accordance with all terms of the Contract of which this Bid is one part.

In accordance with these bid documents, and Addenda numbered _____, the undersigned, as Bidder, proposes to perform at the sites in and/or around Ann Arbor, Michigan, all the work included herein for the amounts set forth in the Bid Forms.

The Bidder declares that it has become fully familiar with the liquidated damage clauses for completion times and for compliance with City Code Chapter 112, understands and agrees that the liquidated damages are for the non-quantifiable aspects of non-compliance and do not cover actual damages that may be shown and agrees that if awarded the Contract, all liquidated damage clauses form part of the Contract.

The Bidder declares that it has become fully familiar with the provisions of Chapter 14, Section 1:319 (Prevailing wages) and Chapter 23 (Living Wage) of the Code of the City of Ann Arbor and that it understands and agrees to comply, to the extent applicable to employees providing services to the City under this Contract, with the wage and reporting requirements stated in the City Code provisions cited. Bidder further agrees that the cited provisions of Chapter 14 and Chapter 23 form a part of this Contract.

The Bidder declares that it has become familiar with the City Conflict of Interest Disclosure Form and certifies that the statement contained therein is true and correct.

The Bidder encloses a certified check or Bid Bond in the amount of 5% of the total of the Bid Price. The Bidder agrees both to contract for the work and to furnish the necessary Bonds and insurance documentation within 10 days after being notified of the acceptance of the Bid.

If this Bid is accepted by the City and the Bidder fails to contract and furnish the required Bonds and insurance documentation within 10 days after being notified of the acceptance of this Bid, then the Bidder shall be considered to have abandoned the Contract and the certified check or Bid Bond accompanying this Bid shall become due and payable to the City.

If the Bidder enters into the Contract in accordance with this Bid, or if this Bid is rejected, then the accompanying check or Bid Bond shall be returned to the Bidder.

In submitting this Bid, it is understood that the right is reserved by the City to accept any Bid, to reject any or all Bids, to waive irregularities and/or informalities in any Bid, and to make the award in any manner the City believes to be in its best interest.

SIGNED THIS _____ DAY OF _____, 2015.

Bidder's Name

Authorized Signature of Bidder

Official Address

(Print Name of Signer Above)

Telephone Number

Email Address for Award Notice

LEGAL STATUS OF BIDDER

(The Bidder shall fill out the appropriate form and strike out the other three.)

Bidder declares that it is:

* A corporation organized and doing business under the laws of the State of _____, for whom _____, bearing the office title of _____, whose signature is affixed to this Bid, is authorized to execute contracts.

NOTE: If not incorporated in Michigan, please attach the corporation's Certificate of Authority

• A limited liability company doing business under the laws of the State of _____, whom _____ bearing the title of _____ whose signature is affixed to this proposal, is authorized to execute contract on behalf of the LLC.

* A partnership, organized under the laws of the state of _____ and filed in the county of _____, whose members are (list all members and the street and mailing address of each) (attach separate sheet if necessary):

* An individual, whose signature with address, is affixed to this Bid: _____
(initial here)

Authorized Official

_____ **Date** _____, 2015

(Print) Name _____ Title _____

Company: _____

Address: _____

Contact Phone () _____ Fax () _____

Email _____

BID FORM

Section 1 – Schedule of Prices

ITEM NO. XXXXXXXX INDICATES MICHIGAN DEPARTMENT OF TRANSPORTATION (MDOT) STANDARD PAY ITEM. SEE “2012 STANDARD SPECIFICATIONS FOR CONSTRUCTION”
 ITEM NO. XXX7XXX INDICATES MDOT MODIFIED PAY ITEM. SEE DETAILED SPECIFICATION CONTAINED IN THE CONTRACT DOCUMENTS.

<u>Item</u>	<u>Description</u>	<u>Unit</u>	<u>Estimated Quantity</u>	<u>Unit Price</u>	<u>Total Price</u>
1500001	Mobilization, Max. ____	LSUM	1	\$ _____	\$ _____
2040025	Fence, Rem	Ft	146	\$ _____	\$ _____
2047011	Clearing, Special	Syd	450	\$ _____	\$ _____
2047051	Structures, Rem Portions, Special	LSUM	1	\$ _____	\$ _____
2080014	Erosion Control, Filter Bag	Ea	2	\$ _____	\$ _____
2080036	Erosion Control, Silt Fence	Ft	310	\$ _____	\$ _____
2080042	Erosion Control, Turbidity Curtain, Deep	Ft	60	\$ _____	\$ _____
7047010	Steel Structure, Cleaning, Partial, Type 4, Pier	Sft	128	\$ _____	\$ _____
7047010	Steel Structure, Coating, Partial, Type 4, Pier	Sft	128	\$ _____	\$ _____
7047010	Steel Structure, Cleaning, Partial, Type 4, Abutment	Sft	126	\$ _____	\$ _____
7047010	Steel Structure, Coating, Partial, Type 4, Abutment	Sft	126	\$ _____	\$ _____
7047051	Cofferdams	LSUM	1	\$ _____	\$ _____
7067051	Bridge Ltg, Furn and Oper	LSUM	1	\$ _____	\$ _____
7060092	Reinforcement, Steel, Epoxy Coated	Lb	25	\$ _____	\$ _____
7067001	Cleaning Bridge Joint	Ft	23	\$ _____	\$ _____
7070070	Structural Steel, Rolled Shape, Erect	Lb	215	\$ _____	\$ _____
7070071	Structural Steel, Rolled Shape, Furn and Fab	Lb	215	\$ _____	\$ _____
7120007	Hand Chipping, Other Than Deck	Cft	139	\$ _____	\$ _____
7120017	Patch, Forming	Sft	278	\$ _____	\$ _____

BID FORM

Section 1 – Schedule of Prices

ITEM NO. XXXXXXXX INDICATES MICHIGAN DEPARTMENT OF TRANSPORTATION (MDOT) STANDARD PAY ITEM. SEE “2012 STANDARD SPECIFICATIONS FOR CONSTRUCTION”
ITEM NO. XXX7XXX INDICATES MDOT MODIFIED PAY ITEM. SEE DETAILED SPECIFICATION CONTAINED IN THE CONTRACT DOCUMENTS.

<u>Item</u>	<u>Description</u>	<u>Unit</u>	<u>Estimated Quantity</u>	<u>Unit Price</u>	<u>Total Price</u>
7120112	Patching Conc, C-L	Cyd	11	\$ _____	\$ _____
7127001	Abutment Crack Repair	Ft	29	\$ _____	\$ _____
7127001	Pier Crack Repair	Ft	18	\$ _____	\$ _____
7127050	Embedded Galvanic Anode, Special	Ea	70	\$ _____	\$ _____
7137050	Support, Column, Temp	Ea	2	\$ _____	\$ _____
8087001	Fence, Chain Link, 60 inch with 3 Strand of Barbed Wire	Ft	146	\$ _____	\$ _____
8120022	Barricade, Type III, High Intensity, Lighted, Furn	Ea	4	\$ _____	\$ _____
8120023	Barricade, Type III, High Intensity, Lighted, Oper	Ea	4	\$ _____	\$ _____
8120350	Sign, Type B, Temp, Prismatic, Furn	Sft	84	\$ _____	\$ _____
8120351	Sign, Type B, Temp, Prismatic, Oper	Sft	84	\$ _____	\$ _____
8120352	Sign, Type B, Temp, Prismatic, Special, Furn	Sft	9	\$ _____	\$ _____
8120353	Sign, Type B, Temp, Prismatic, Special, Oper	Sft	9	\$ _____	\$ _____
8137021	Grout Filled Bags	Cyd	16	\$ _____	\$ _____
8167011	Slope Restoration	Syd	620	\$ _____	\$ _____
TOTAL				\$ _____	

BID FORM

Section 2 - Material and Equipment Alternates

The Base Bid proposal price shall include materials and equipment selected from the designated items and manufacturers listed in the bidding documents. This is done to establish uniformity in bidding and to establish standards of quality for the items named.

If the Contractor wishes to quote alternate items for consideration by the City, it may do so under this Section. A complete description of the item and the proposed price differential must be provided. Unless approved at the time of award, substitutions where items are specifically named will be considered only as a negotiated change in Contract Sum.

<u>Item Number</u>	<u>Description</u>	<u>Add/Deduct Amount</u>
--------------------	--------------------	--------------------------

If the Bidder does not suggest any material or equipment alternate, the Bidder **MUST** complete the following statement:

For the work outlined in this request for bid, the bidder does NOT propose any material or equipment alternate under the Contract.

Signature of Authorized Representative of Bidder _____

BID FORM

Section 3 - Time Alternate

If the Bidder takes exception to the time (70 calendar days) stipulated in Article III of the Contract, Time of Completion, page C-2, it is requested to stipulate below its proposed time for performance of the work. Consideration will be given to time in evaluating bids.

If the Bidder does not suggest any time alternate, the Bidder **MUST** complete the following statement:

For the work outlined in this request for bid, the bidder does NOT propose any time alternate under the Contract.

Signature of Authorized Representative of Bidder _____

BID FORM

Section 4 - Major Subcontractors

For purposes of this Contract, a Subcontractor is anyone (other than the Contractor) who performs work (other than or in addition to the furnishing of materials, plans or equipment) at or about the construction site, directly or indirectly for or on behalf of the Contractor (and whether or not in privity of Contract with the Contractor), but shall not include any individual who furnishes merely the individual's own personal labor or services.

For the work outlined in these documents the Bidder expects to engage the following major subcontractors to perform the work identified:

<u>Subcontractor (Name and Address)</u>	<u>Work</u>	<u>Amount</u>
---	-------------	---------------

If the Bidder does not expect to engage any major subcontractor, the Bidder **MUST** complete the following statement:

For the work outlined in this request for bid, the bidder does NOT expect to engage any major subcontractor to perform work under the Contract.

Signature of Authorized Representative of Bidder _____

SAMPLE STANDARD CONTRACT

If a contract is awarded, the selected contractor will be required to adhere to a set of general contract provisions which will become a part of any formal agreement. These provisions are general principles which apply to all contractors of service to the City of Ann Arbor such as the following:

CONTRACT

THIS AGREEMENT is made on the _____ day of _____, 2015, between the CITY OF ANN ARBOR, a Michigan Municipal Corporation, 301 East Huron Street, Ann Arbor, Michigan 48104 ("City") and _____ ("Contractor")

(An individual/partnership/corporation, include state of incorporation)

(Address)

Based upon the mutual promises below, the Contractor and the City agree as follows:

ARTICLE I - Scope of Work

The Contractor agrees to furnish all of the materials, equipment and labor necessary; and to abide by all the duties and responsibilities applicable to it for the project titled "2015 WWTP Access Bridge Repair Project" in accordance with the requirements and provisions of the following documents, including all written modifications incorporated into any of the documents, which are incorporated as part of this Contract:

Human Rights Division Contract
and Living Wage Declaration of
Compliance Forms (if applicable)
Vendor Conflict of Interest Form
Bid Forms
Contract and Exhibits
Bonds

General Conditions
Standard Specifications
Detailed Specifications
Plans
Addenda

ARTICLE II - Definitions

Administering Service Area/Unit means Public Services Area

Project means 2015 WWTP Access Bridge Repair Project, ITB No. 4390

ARTICLE III - Time of Completion

- (A) The work to be completed under this Contract shall begin immediately on the date specified in the Notice to Proceed issued by the City.
- (B) The entire work for this Contract shall be completed within seventy (70) calendar days.
- (C) Failure to complete all the work within the time specified above, including any extension granted in writing by the Supervising Professional, shall obligate the Contractor to pay the City, as liquidated damages and not as a penalty, an amount equal to \$600 for each calendar day of delay in the completion of all the work. If any liquidated damages are unpaid by the Contractor, the City shall be entitled to deduct these unpaid liquidated damages from the monies due the Contractor.

The liquidated damages are for the non-quantifiable aspects of any of the previously identified events and do not cover actual damages that can be shown or quantified nor are they intended to preclude recovery of actual damages in addition to the recovery of liquidated damages.

ARTICLE IV - The Contract Sum

- (A) The City shall pay to the Contractor for the performance of the Contract, the unit prices as given in the Bid Forms for the estimated bid total of:

_____ Dollars (\$ _____)

- (B) The amount paid shall be equitably adjusted to cover changes in the work ordered by the Supervising Professional but not required by the Contract Documents. Increases or decreases shall be determined only by written agreement between the City and Contractor.

ARTICLE V - Assignment

This Contract may not be assigned or subcontracted without the written consent of the City.

ARTICLE VI - Choice of Law

This Contract shall be construed, governed, and enforced in accordance with the laws of the State of Michigan. By executing this agreement, the Contractor and the City agree to venue in a court of appropriate jurisdiction sitting within Washtenaw County for purposes of any action arising under this Contract. The parties stipulate that the venue referenced in this Contract is for convenience and waive any claim of non-convenience.

Whenever possible, each provision of the Contract will be interpreted in a manner as to be effective and valid under applicable law. The prohibition or invalidity, under applicable law, of any provision will not invalidate the remainder of the Contract.

ARTICLE VII - Relationship of the Parties

The parties of the Contract agree that it is not a Contract of employment but is a Contract to accomplish a specific result. Contractor is an independent Contractor performing services for the City. Nothing contained in this Contract shall be deemed to constitute any other relationship between the City and the Contractor.

Contractor certifies that it has no personal or financial interest in the project other than the compensation it is to receive under the Contract. Contractor certifies that it is not, and shall not become, overdue or in default to the City for any Contract, debt, or any other obligation to the City including real or personal property taxes. City shall have the right to set off any such debt against compensation awarded for services under this agreement.

ARTICLE VIII - Notice

All notices given under this Contract shall be in writing, and shall be by personal delivery or by certified mail with return receipt requested to the parties at their respective addresses as specified in the Contract Documents or other address the Contractor may specify in writing.

ARTICLE IX - Indemnification

To the fullest extent permitted by law, Contractor shall indemnify, defend and hold harmless the City, its officers, employees and agents harmless from all suits, claims, judgments and expenses including attorney’s fees resulting or alleged to result, in whole or in part, from any act or omission, which is in any way connected or associated with this Contract, by the Contractor or anyone acting on the Contractor’s behalf under this Contract. Contractor shall not be responsible to indemnify the City for losses or damages caused by or resulting from the City’s sole negligence.

ARTICLE X - Entire Agreement

This Contract represents the entire understanding between the City and the Contractor and it supersedes all prior representations or agreements whether written or oral. Neither party has relied on any prior representations in entering into this Contract. This Contract may be altered, amended or modified only by written amendment signed by the City and the Contractor.

FOR CONTRACTOR

By _____

Its: _____

FOR THE CITY OF ANN ARBOR

By _____
Christopher Taylor, Mayor

By _____
Jacqueline Beaudry, City Clerk

Approved as to substance

By _____
Steven D. Powers, City Administrator

By _____
Craig Hupy, Services Area Administrator

Approved as to form and content

Stephen K. Postema, City Attorney

PERFORMANCE BOND

(1) _____ of _____ (referred to as "Principal"), and _____, a corporation duly authorized to do business in the State of Michigan (referred to as "Surety"), are bound to the City of Ann Arbor, Michigan (referred to as "City"), for

\$ _____, the payment of which Principal and Surety bind themselves, their heirs, executors, administrators, successors and assigns, jointly and severally, by this bond.

(2) The Principal has entered a written Contract with the City dated _____, 201_, for: _____ and _____ this bond is given for that Contract in compliance with Act No. 213 of the Michigan Public Acts of 1963, as amended, being MCL 129.201 et seq.

(3) Whenever the Principal is declared by the City to be in default under the Contract, the Surety may promptly remedy the default or shall promptly:

(a) complete the Contract in accordance with its terms and conditions; or

(b) obtain a bid or bids for submission to the City for completing the Contract in accordance with its terms and conditions, and upon determination by Surety of the lowest responsible bidder, arrange for a Contract between such bidder and the City, and make available, as work progresses, sufficient funds to pay the cost of completion less the balance of the Contract price; but not exceeding, including other costs and damages for which Surety may be liable hereunder, the amount set forth in paragraph 1.

(4) Surety shall have no obligation to the City if the Principal fully and promptly performs under the Contract.

(5) Surety agrees that no change, extension of time, alteration or addition to the terms of the Contract or to the work to be performed thereunder, or the specifications accompanying it shall in any way affect its obligations on this bond, and waives notice of any such change, extension of time, alteration or addition to the terms of the Contract or to the work, or to the specifications.

SIGNED AND SEALED this _____ day of _____, 2015.

(Name of Surety Company)

By _____
(Signature)

Its _____
(Title of Office)

Approved as to form:

Stephen K. Postema, City Attorney

(Name of Principal)

By _____
(Signature)

Its _____
(Title of Office)

Name and address of agent:

LABOR AND MATERIAL BOND

- (1) _____
of _____(referred to as "Principal"), and _____, a corporation duly authorized to do business in the State of Michigan, (referred to as "Surety"), are bound to the City of Ann Arbor, Michigan (referred to as "City"), for the use and benefit of claimants as defined in Act 213 of Michigan Public Acts of 1963, as amended, being MCL 129.201 et seq., in the amount of \$ _____, for the payment of which Principal and Surety bind themselves, their heirs, executors, administrators, successors and assigns, jointly and severally, by this bond.
- (2) The Principal has entered a written Contract with the City, dated _____, 2015, for _____; and this bond is given for that Contract in compliance with Act No. 213 of the Michigan Public Acts of 1963 as amended;
- (3) If the Principal fails to promptly and fully repay claimants for labor and material reasonably required under the Contract, the Surety shall pay those claimants.
- (4) Surety's obligations shall not exceed the amount stated in paragraph 1, and Surety shall have no obligation if the Principal promptly and fully pays the claimants.

SIGNED AND SEALED this _____ day of _____, 2015.

(Name of Surety Company)
By _____
(Signature)
Its _____
(Title of Office)

(Name of Principal)
By _____
(Signature)
Its _____
(Title of Office)

Approved as to form:

Name and address of agent:

Stephen K. Postema, City Attorney

GENERAL CONDITIONS

Section 1 - Execution, Correlation and Intent of Documents

The contract documents shall be signed in 2 copies by the City and the Contractor.

The contract documents are complementary and what is called for by any one shall be binding. The intention of the documents is to include all labor and materials, equipment and transportation necessary for the proper execution of the work. Materials or work described in words which so applied have a well-known technical or trade meaning have the meaning of those recognized standards.

In case of a conflict among the contract documents listed below in any requirement(s), the requirement(s) of the document listed first shall prevail over any conflicting requirement(s) of a document listed later.

(1) Addenda in reverse chronological order; (2) Detailed Specifications; (3) Standard Specifications; (4) Plans; (5) General Conditions; (6) Contract; (7) Bid Forms; (8) Bond Forms; (9) Bid.

Section 2 - Order of Completion

The Contractor shall submit with each invoice, and at other times reasonably requested by the Supervising Professional, schedules showing the order in which the Contractor proposes to carry on the work. They shall include the dates at which the Contractor will start the several parts of the work, the estimated dates of completion of the several parts, and important milestones within the several parts.

Section 3 - Familiarity with Work

The Bidder or its representative shall make personal investigations of the site of the work and of existing structures and shall determine to its own satisfaction the conditions to be encountered, the nature of the ground, the difficulties involved, and all other factors affecting the work proposed under this Contract. The Bidder to whom this Contract is awarded will not be entitled to any additional compensation unless conditions are clearly different from those which could reasonably have been anticipated by a person making diligent and thorough investigation of the site.

The Bidder shall immediately notify the City upon discovery, and in every case prior to submitting its Bid, of every error or omission in the bidding documents that would be identified by a reasonably competent, diligent Bidder. In no case will a Bidder be allowed the benefit of extra compensation or time to complete the work under this Contract for extra expenses or time spent as a result of the error or omission.

Section 4 - Wage Requirements

Under this Contract, the Contractor shall conform to Chapter 14 of Title I of the Code of the City of Ann Arbor as amended; which in part states "...that all craftsmen, mechanics and laborers employed directly on the site in connection with said improvements, including said employees of subcontractors, shall receive the prevailing wage for the corresponding classes of craftsmen,

mechanics and laborers, as determined by statistics for the Ann Arbor area compiled by the United States Department of Labor. At the request of the City, any contractor or subcontractor shall provide satisfactory proof of compliance with the contract provisions required by the Section."

Where the Contract and the Ann Arbor City Ordinance are silent as to definitions of terms required in determining contract compliance with regard to prevailing wages, the definitions provided in the Davis-Bacon Act as amended (40 U.S.C. 278-a to 276-a-7) for the terms shall be used.

Further, to the extent that any employees of the Contractor providing services under this contract are not part of the class of craftsmen, mechanics and laborers who receive a prevailing wage in conformance with Section 1:319 of Chapter 14 of Title I of the Code of the City of Ann Arbor, the Contractor agrees to conform to Chapter 23 of Title I of the Code of the City of Ann Arbor, as amended, which in part states:

1:814. Applicability.

- (1) This Chapter shall apply to any person that is a contractor/bidder or grantee as defined in Section 1:813 that employs or contracts with five (5) or more individuals; provided, however, that this Chapter shall not apply to a non-profit contractor/bidder or non-profit grantee unless it employs or contracts with ten (10) or more individuals.
- (2) This Chapter shall apply to any grant, contract, or subcontract or other form of financial assistance awarded to or entered into with a contractor/bidder or grantee after the effective date of this Chapter and to the extension or renewal after the effective date of this Chapter of any grant, contract, or subcontract or other form of financial assistance with a contractor/bidder or grantee.

1:815. Living Wages Required.

- (1) Every contractor/bidder or grantee, as defined in Section 1:813, shall pay its covered employees a living wage as established in this Section.
 - (a) For a covered employer that provides employee health care to its employees, the living wage shall be \$12.52 an hour, or the adjusted amount hereafter established under Section 1:815(3).
 - (b) For a covered employer that does not provide health care to its employees, the living wage shall be \$13.96 an hour, or the adjusted amount hereafter established under Section 1:815(3).
- (2) In order to qualify to pay the living wage rate for covered employers providing employee health care under subsection 1:815(1)(a), a covered employer shall furnish proof of said health care coverage and payment therefor to the City Administrator or his/her designee.
- (3) The amount of the living wage established in this Section shall be adjusted upward no later than April 30, 2002, and every year thereafter by a percentage equal to the percentage increase, if any, in the federal poverty guidelines as published by the United States Department of Health and Human Services for the years 2001 and 2002. Subsequent annual adjustments shall be based upon the percentage increase, if any, in the United States Department of Health and Human Services poverty guidelines when comparing the prior calendar year's poverty guidelines to the present calendar year's guidelines. The applicable percentage amount will be converted to an amount in cents by multiplying the existing wage under Section 1.815(1)(b) by said percentage, rounding upward to the next cent, and adding this amount of cents to the existing living wage

levels established under Sections 1:815(1)(a) and 1:815(1)(b). Prior to April 1 of each calendar year, the City will notify any covered employer of this adjustment by posting a written notice in a prominent place in City Hall, and, in the case of a covered employer that has provided an address of record to the City, by a written letter to each such covered employer.

Contractor agrees that all subcontracts entered into by the Contractor shall contain similar wage provision covering subcontractor's employees who perform work on this contract.

Section 5 - Non-Discrimination

The Contractor agrees to comply, and to require its subcontractor(s) to comply, with the nondiscrimination provisions of Section 209 of the Elliot-Larsen Civil Rights Act (MCL 37.2209). The Contractor further agrees to comply with the nondiscrimination provisions of Chapter 112 of the Ann Arbor City Code and to assure that applicants are employed and that employees are treated during employment in a manner which provides equal employment opportunity. The Contractor further agrees to comply with the provisions of Section 9:158 of Chapter 112 of the Ann Arbor City Code and in particular the following excerpts:

9:158. - Nondiscrimination by city contractors.

- (1) All contractors proposing to do business with the City of Ann Arbor shall satisfy the contract compliance administrative policy adopted by the City Administrator in accordance with the guidelines of this section. All city contractors shall ensure that applicants are employed and that employees are treated during employment in a manner which provides equal employment opportunity and tends to eliminate inequality based upon any classification protected by this chapter. All contractors shall agree not to discriminate against an employee or applicant for employment with respect to hire, tenure, terms, conditions, or privileges of employment, or a matter directly or indirectly related to employment, because of any applicable protected classification.
- (2) All contractors shall be required to post a copy of Ann Arbor's Non-Discrimination Ordinance at all work locations where its employees provide services under a contract with the city.
- (3) Upon request, each prospective contractor shall submit to the city data showing current total employment by occupational category, sex and minority group and shall respond to information requests documenting its equal employment opportunity policies and procedures.
- (4) If the contract which is being awarded includes federal requirements for affirmative action, each prospective contractor shall submit to the city data showing current total employment by occupational category, sex and minority group. If, after verifying this data, the City Administrator's designee concludes that it indicates total minority and female employment commensurate with their availability within the contractor's labor recruitment area, i.e., the area from which the contractor can reasonably be expected to recruit, said contractor shall be accepted by the City Administrator's designee as having fulfilled affirmative action requirements for the period of the contract at which time the City Administrator's designee shall conduct another review. If the data demonstrates an under-representation the contractor shall develop an affirmative action program for review by the City Administrator's designee. Said program shall include specific goals and timetables for the hiring and promotion of minorities and females. Said goals shall reflect the availability of minorities and females within the contractor's labor recruitment area. In the case of construction contractors, the City Administrator's designee shall use for employment verification the labor recruitment area of the Ann Arbor metropolitan statistical area. Construction contractors determined to be in compliance shall be accepted by the City Administrator's designee as having fulfilled affirmative action requirements for a period of 1 year at which time the City Administrator's designee shall conduct another review.

- (5) In hiring for construction projects, contractors shall make good faith efforts to employ local persons, so as to enhance the local economy.
- (6) All contracts shall include provisions through which the contractor agrees to follow all applicable federal and state laws.
- (7) The City Administrator's designee shall monitor the compliance of each contractor with the nondiscrimination provisions of each contract. The City Administrator's designee, together with the Human Rights Commission, shall develop procedures and regulations consistent with the administrative policy adopted by the City Administrator for notice and enforcement of non-compliance. Such procedures and regulations shall include a provision for the posting of contractors not in compliance.
- (8) The City Administrator's designee will provide the City's Human Rights Commission with an annual summary report of contracts awarded; affirmative action requirements reviewed, where applicable; any complaints received alleging violation of the contractor's non-discrimination requirements, and actions taken. The Human Rights Commission will be provided, at its request, with additional information related to the report. The Human Rights Commission and the City Administrator's designee will report annually to the City Council on compliance of city contractors with this chapter.
- (9) All city contracts shall provide further that breach of the obligation not to discriminate shall be a material breach of the contract for which the city shall be entitled, at its option, to do any or all of the following:
 - (a) Cancel, terminate, or suspend the contract in whole or part and/or refuse to make any required periodic payments under the contract;
 - (b) Declare the contractor ineligible for the award of any future contracts with the city for a specified length of time;
 - (c) Recover liquidated damages of a specified sum, said sum to be that percentage of the labor expenditure for the time period involved which would have accrued to protected class members had the discrimination provisions not been breached;
 - (d) Impose for each day of non-compliance, liquidated damages of a specified sum, based upon the following schedule:

Contract Amount	Assessed Damages Per Day of Non-Compliance
\$25,000—99,999	\$50.00
100,000—199,999	100.00
200,000—499,999	150.00
500,000—1,499,999	200.00
1,500,000—2,999,999	250.00
3,000,000—4,999,999	300.00
5,000,000 and above	500.00

- (e) In addition the contractor shall be liable for any costs or expenses incurred by the City of Ann Arbor in obtaining from other sources the work and services to be rendered or performed or the goods or properties to be furnished or delivered to the city under this contract.

(Ord. No. 14-25, § 1, 10-20-14)

Section 6 - Materials, Appliances, Employees

Unless otherwise stipulated, the Contractor shall provide and pay for all materials, labor, water, tools, equipment, light, power, transportation, and other facilities necessary or used for the execution and completion of the work. Unless otherwise specified, all materials incorporated in the permanent work shall be new, and both workmanship and materials shall be of the highest quality. The Contractor shall, if required, furnish satisfactory evidence as to the kind and quality of materials.

The Contractor shall at all times enforce strict discipline and good order among its employees, and shall seek to avoid employing on the work any unfit person or anyone not skilled in the work assigned.

Adequate sanitary facilities shall be provided by the Contractor.

Section 7 - Qualifications for Employment

The Contractor shall employ competent laborers and mechanics for the work under this Contract. For work performed under this Contract, employment preference shall be given to qualified local residents.

Section 8 - Royalties and Patents

The Contractor shall pay all royalties and license fees. It shall defend all suits or claims for infringements of any patent rights and shall hold the City harmless from loss on account of infringement except that the City shall be responsible for all infringement loss when a particular process or the product of a particular manufacturer or manufacturers is specified, unless the City has notified the Contractor prior to the signing of the Contract that the particular process or product is patented or is believed to be patented.

Section 9 - Permits and Regulations

The Contractor must secure and pay for all permits, permit or plan review fees and licenses necessary for the prosecution of the work. These include but are not limited to City building permits, right-of-way permits, lane closure permits, right-of-way occupancy permits, and the like. The City shall secure and pay for easements shown on the plans unless otherwise specified.

The Contractor shall give all notices and comply with all laws, ordinances, rules and regulations bearing on the conduct of the work as drawn and specified. If the Contractor observes that the contract documents are at variance with those requirements, it shall promptly notify the Supervising Professional in writing, and any necessary changes shall be adjusted as provided in the Contract for changes in the work.

Section 10 - Protection of the Public and of Work and Property

The Contractor is responsible for the means, methods, sequences, techniques and procedures of construction and safety programs associated with the work contemplated by this contract. The Contractor, its agents or sub-contractors, shall comply with the "General Rules and Regulations for the Construction Industry" as published by the Construction Safety Commission of the State of Michigan and to all other local, State and National laws, ordinances, rules and regulations pertaining to safety of persons and property.

The Contractor shall take all necessary and reasonable precautions to protect the safety of the public. It shall continuously maintain adequate protection of all work from damage, and shall take all necessary and reasonable precautions to adequately protect all public and private

property from injury or loss arising in connection with this Contract. It shall make good any damage, injury or loss to its work and to public and private property resulting from lack of reasonable protective precautions, except as may be due to errors in the contract documents, or caused by agents or employees of the City. The Contractor shall obtain and maintain sufficient insurance to cover damage to any City property at the site by any cause.

In an emergency affecting the safety of life, or the work, or of adjoining property, the Contractor is, without special instructions or authorization from the Supervising Professional, permitted to act at its discretion to prevent the threatened loss or injury. It shall also so act, without appeal, if authorized or instructed by the Supervising Professional.

Any compensation claimed by the Contractor for emergency work shall be determined by agreement or in accordance with the terms of Claims for Extra Cost - Section 15.

Section 11 - Inspection of Work

The City shall provide sufficient competent personnel for the inspection of the work.

The Supervising Professional shall at all times have access to the work whenever it is in preparation or progress, and the Contractor shall provide proper facilities for access and for inspection.

If the specifications, the Supervising Professional's instructions, laws, ordinances, or any public authority require any work to be specially tested or approved, the Contractor shall give the Supervising Professional timely notice of its readiness for inspection, and if the inspection is by an authority other than the Supervising Professional, of the date fixed for the inspection. Inspections by the Supervising Professional shall be made promptly, and where practicable at the source of supply. If any work should be covered up without approval or consent of the Supervising Professional, it must, if required by the Supervising Professional, be uncovered for examination and properly restored at the Contractor's expense.

Re-examination of any work may be ordered by the Supervising Professional, and, if so ordered, the work must be uncovered by the Contractor. If the work is found to be in accordance with the contract documents, the City shall pay the cost of re-examination and replacement. If the work is not in accordance with the contract documents, the Contractor shall pay the cost.

Section 12 - Superintendence

The Contractor shall keep on the work site, during its progress, a competent superintendent and any necessary assistants, all satisfactory to the Supervising Professional. The superintendent will be responsible to perform all on-site project management for the Contractor. The superintendent shall be experienced in the work required for this Contract. The superintendent shall represent the Contractor and all direction given to the superintendent shall be binding as if given to the Contractor. Important directions shall immediately be confirmed in writing to the Contractor. Other directions will be confirmed on written request. The Contractor shall give efficient superintendence to the work, using its best skill and attention.

Section 13 - Changes in the Work

The City may make changes to the quantities of work within the general scope of the Contract at any time by a written order and without notice to the sureties. If the changes add to or deduct from the extent of the work, the Contract Sum shall be adjusted accordingly. All the changes shall be executed under the conditions of the original Contract except that any claim for extension of time caused by the change shall be adjusted at the time of ordering the change.

In giving instructions, the Supervising Professional shall have authority to make minor changes in the work not involving extra cost and not inconsistent with the purposes of the work, but otherwise, except in an emergency endangering life or property, no extra work or change shall be made unless in pursuance of a written order by the Supervising Professional, and no claim for an addition to the Contract Sum shall be valid unless the additional work was ordered in writing.

The Contractor shall proceed with the work as changed and the value of the work shall be determined as provided in Claims for Extra Cost - Section 15.

Section 14 - Extension of Time

Extension of time stipulated in the Contract for completion of the work will be made if and as the Supervising Professional may deem proper under any of the following circumstances:

- (1) When work under an extra work order is added to the work under this Contract;
- (2) When the work is suspended as provided in Section 20;
- (3) When the work of the Contractor is delayed on account of conditions which could not have been foreseen, or which were beyond the control of the Contractor, and which were not the result of its fault or negligence;
- (4) Delays in the progress of the work caused by any act or neglect of the City or of its employees or by other Contractors employed by the City;
- (5) Delay due to an act of Government;
- (6) Delay by the Supervising Professional in the furnishing of plans and necessary information;
- (7) Other cause which in the opinion of the Supervising Professional entitles the Contractor to an extension of time.

The Contractor shall notify the Supervising Professional within 7 days of an occurrence or conditions which, in the Contractor's opinion, entitle it to an extension of time. The notice shall be in writing and submitted in ample time to permit full investigation and evaluation of the Contractor's claim. The Supervising Professional shall acknowledge receipt of the Contractor's notice within 7 days of its receipt. Failure to timely provide the written notice shall constitute a waiver by the Contractor of any claim.

In situations where an extension of time in contract completion is appropriate under this or any other section of the contract, the Contractor understands and agrees that the only available adjustment for events that cause any delays in contract completion shall be extension of the required time for contract completion and that there shall be no adjustments in the money due the Contractor on account of the delay.

Section 15 - Claims for Extra Cost

If the Contractor claims that any instructions by drawings or other media issued after the date of the Contract involved extra cost under this Contract, it shall give the Supervising Professional written notice within 7 days after the receipt of the instructions, and in any event before proceeding to execute the work, except in emergency endangering life or property. The procedure shall then be as provided for Changes in the Work-Section 13. No claim shall be valid unless so made.

If the Supervising Professional orders, in writing, the performance of any work not covered by the contract documents, and for which no item of work is provided in the Contract, and for which no unit price or lump sum basis can be agreed upon, then the extra work shall be done on a Cost-Plus-Percentage basis of payment as follows:

- (1) The Contractor shall be reimbursed for all reasonable costs incurred in doing the work, and shall receive an additional payment of 15% of all the reasonable costs to cover both its indirect overhead costs and profit;
- (2) The term "Cost" shall cover all payroll charges for employees and supervision required under the specific order, together with all worker's compensation, Social Security, pension and retirement allowances and social insurance, or other regular payroll charges on same; the cost of all material and supplies required of either temporary or permanent character; rental of all power-driven equipment at agreed upon rates, together with cost of fuel and supply charges for the equipment; and any costs incurred by the Contractor as a direct result of executing the order, if approved by the Supervising Professional;
- (3) If the extra is performed under subcontract, the subcontractor shall be allowed to compute its charges as described above. The Contractor shall be permitted to add an additional charge of 5% percent to that of the subcontractor for the Contractor's supervision and contractual responsibility;
- (4) The quantities and items of work done each day shall be submitted to the Supervising Professional in a satisfactory form on the succeeding day, and shall be approved by the Supervising Professional and the Contractor or adjusted at once;
- (5) Payments of all charges for work under this Section in any one month shall be made along with normal progress payments. Retainage shall be in accordance with Progress Payments-Section 16.

No additional compensation will be provided for additional equipment, materials, personnel, overtime or special charges required to perform the work within the time requirements of the Contract.

When extra work is required and no suitable price for machinery and equipment can be determined in accordance with this Section, the hourly rate paid shall be 1/40 of the basic weekly rate listed in the Rental Rate Blue Book published by Dataquest Incorporated and applicable to the time period the equipment was first used for the extra work. The hourly rate will be deemed to include all costs of operation such as bucket or blade, fuel, maintenance, "regional factors", insurance, taxes, and the like, but not the costs of the operator.

Section 16 - Progress Payments

The Contractor shall submit each month, or at longer intervals, if it so desires, an invoice covering work performed for which it believes payment, under the Contract terms, is due. The submission shall be to the City's Finance Department - Accounting Division. The Supervising Professional will, within 10 days following submission of the invoice, prepare a certificate for payment for the work in an amount to be determined by the Supervising Professional as fairly representing the acceptable work performed during the period covered by the Contractor's invoice. To insure the proper performance of this Contract, the City will retain a percentage of the estimate in accordance with Act 524, Public Acts of 1980. The City will then, following the receipt of the Supervising Professional's Certificate, make payment to the Contractor as soon as feasible, which is anticipated will be within 15 days.

An allowance may be made in progress payments if substantial quantities of permanent material

have been delivered to the site but not incorporated in the completed work if the Contractor, in the opinion of the Supervising Professional, is diligently pursuing the work under this Contract. Such materials shall be properly stored and adequately protected. Allowance in the estimate shall be at the invoice price value of the items. Notwithstanding any payment of any allowance, all risk of loss due to vandalism or any damages to the stored materials remains with the Contractor.

In the case of Contracts which include only the Furnishing and Delivering of Equipment, the payments shall be; 60% of the Contract Sum upon the delivery of all equipment to be furnished, or in the case of delivery of a usable portion of the equipment in advance of the total equipment delivery, 60% of the estimated value of the portion of the equipment may be paid upon its delivery in advance of the time of the remainder of the equipment to be furnished; 30% of the Contract Sum upon completion of erection of all equipment furnished, but not later than 60 days after the date of delivery of all of the equipment to be furnished; and payment of the final 10% on final completion of erection, testing and acceptance of all the equipment to be furnished; but not later than 180 days after the date of delivery of all of the equipment to be furnished, unless testing has been completed and shows the equipment to be unacceptable.

With each invoice for periodic payment, the Contractor shall enclose a Contractor's Declaration - Section 43, and an updated project schedule per Order of Completion - Section 2.

Section 17 - Deductions for Uncorrected Work

If the Supervising Professional decides it is inexpedient to correct work that has been damaged or that was not done in accordance with the Contract, an equitable deduction from the Contract price shall be made.

Section 18 - Correction of Work Before Final Payment

The Contractor shall promptly remove from the premises all materials condemned by the Supervising Professional as failing to meet Contract requirements, whether incorporated in the work or not, and the Contractor shall promptly replace and re-execute the work in accordance with the Contract and without expense to the City and shall bear the expense of making good all work of other contractors destroyed or damaged by the removal or replacement.

If the Contractor does not remove the condemned work and materials within 10 days after written notice, the City may remove them and, if the removed material has value, may store the material at the expense of the Contractor. If the Contractor does not pay the expense of the removal within 10 days thereafter, the City may, upon 10 days written notice, sell the removed materials at auction or private sale and shall pay to the Contractor the net proceeds, after deducting all costs and expenses that should have been borne by the Contractor. If the removed material has no value, the Contractor must pay the City the expenses for disposal within 10 days of invoice for the disposal costs.

The inspection or lack of inspection of any material or work pertaining to this Contract shall not relieve the Contractor of its obligation to fulfill this Contract and defective work shall be made good. Unsuitable materials may be rejected by the Supervising Professional notwithstanding that the work and materials have been previously overlooked by the Supervising Professional and accepted or estimated for payment or paid for. If the work or any part shall be found defective at any time before the final acceptance of the whole work, the Contractor shall forthwith make good the defect in a manner satisfactory to the Supervising Professional. The judgment and the decision of the Supervising Professional as to whether the materials supplied and the work done under this Contract comply with the requirements of the Contract shall be conclusive and final.

Section 19 - Acceptance and Final Payment

Upon receipt of written notice that the work is ready for final inspection and acceptance, the Supervising Professional will promptly make the inspection. When the Supervising Professional finds the work acceptable under the Contract and the Contract fully performed, the Supervising Professional will promptly sign and issue a final certificate stating that the work required by this Contract has been completed and is accepted by the City under the terms and conditions of the Contract. The entire balance found to be due the Contractor, including the retained percentage, shall be paid to the Contractor by the City within 30 days after the date of the final certificate.

Before issuance of final certificates, the Contractor shall file with the City:

- (1) The consent of the surety to payment of the final estimate;
- (2) The Contractor's Affidavit in the form required by Section 44.

In case the Affidavit or consent is not furnished, the City may retain out of any amount due the Contractor, sums sufficient to cover all lienable claims.

The making and acceptance of the final payment shall constitute a waiver of all claims by the City except those arising from:

- (1) unsettled liens;
- (2) faulty work appearing within 12 months after final payment;
- (3) hidden defects in meeting the requirements of the plans and specifications;
- (4) manufacturer's guarantees.

It shall also constitute a waiver of all claims by the Contractor, except those previously made and still unsettled.

Section 20 - Suspension of Work

The City may at any time suspend the work, or any part by giving 5 days notice to the Contractor in writing. The work shall be resumed by the Contractor within 10 days after the date fixed in the written notice from the City to the Contractor to do so. The City shall reimburse the Contractor for expense incurred by the Contractor in connection with the work under this Contract as a result of the suspension.

If the work, or any part, shall be stopped by the notice in writing, and if the City does not give notice in writing to the Contractor to resume work at a date within 90 days of the date fixed in the written notice to suspend, then the Contractor may abandon that portion of the work suspended and will be entitled to the estimates and payments for all work done on the portions abandoned, if any, plus 10% of the value of the work abandoned, to compensate for loss of overhead, plant expense, and anticipated profit.

Section 21 - Delays and the City's Right to Terminate Contract

If the Contractor refuses or fails to prosecute the work, or any separate part of it, with the diligence required to insure completion, ready for operation, within the allowable number of consecutive calendar days specified plus extensions, or fails to complete the work within the

required time, the City may, by written notice to the Contractor, terminate its right to proceed with the work or any part of the work as to which there has been delay. After providing the notice the City may take over the work and prosecute it to completion, by contract or otherwise, and the Contractor and its sureties shall be liable to the City for any excess cost to the City. If the Contractor's right to proceed is terminated, the City may take possession of and utilize in completing the work, any materials, appliances and plant as may be on the site of the work and useful for completing the work. The right of the Contractor to proceed shall not be terminated or the Contractor charged with liquidated damages where an extension of time is granted under Extension of Time - Section 14.

If the Contractor is adjudged a bankrupt, or if it makes a general assignment for the benefit of creditors, or if a receiver is appointed on account of its insolvency, or if it persistently or repeatedly refuses or fails except in cases for which extension of time is provided, to supply enough properly skilled workers or proper materials, or if it fails to make prompt payments to subcontractors or for material or labor, or persistently disregards laws, ordinances or the instructions of the Supervising Professional, or otherwise is guilty of a substantial violation of any provision of the Contract, then the City, upon the certificate of the Supervising Professional that sufficient cause exists to justify such action, may, without prejudice to any other right or remedy and after giving the Contractor 3 days written notice, terminate this Contract. The City may then take possession of the premises and of all materials, tools and appliances thereon and without prejudice to any other remedy it may have, make good the deficiencies or finish the work by whatever method it may deem expedient, and deduct the cost from the payment due the Contractor. The Contractor shall not be entitled to receive any further payment until the work is finished. If the expense of finishing the work, including compensation for additional managerial and administrative services exceeds the unpaid balance of the Contract Sum, the Contractor and its surety are liable to the City for any excess cost incurred. The expense incurred by the City, and the damage incurred through the Contractor's default, shall be certified by the Supervising Professional.

Section 22 - Contractor's Right to Terminate Contract

If the work should be stopped under an order of any court, or other public authority, for a period of 3 months, through no act or fault of the Contractor or of anyone employed by it, then the Contractor may, upon 7 days written notice to the City, terminate this Contract and recover from the City payment for all acceptable work executed plus reasonable profit.

Section 23 - City's Right To Do Work

If the Contractor should neglect to prosecute the work properly or fail to perform any provision of this Contract, the City, 3 days after giving written notice to the Contractor and its surety may, without prejudice to any other remedy the City may have, make good the deficiencies and may deduct the cost from the payment due to the Contractor.

Section 24 - Removal of Equipment and Supplies

In case of termination of this Contract before completion, from any or no cause, the Contractor, if notified to do so by the City, shall promptly remove any part or all of its equipment and supplies from the property of the City, failing which the City shall have the right to remove the equipment and supplies at the expense of the Contractor.

The removed equipment and supplies may be stored by the City and, if all costs of removal and storage are not paid by the Contractor within 10 days of invoicing, the City upon 10 days written notice may sell the equipment and supplies at auction or private sale, and shall pay the Contractor the net proceeds after deducting all costs and expenses that should have been borne by the Contractor and after deducting all amounts claimed due by any lien holder of the equipment or supplies.

Section 25 - Responsibility for Work and Warranties

The Contractor assumes full responsibility for any and all materials and equipment used in the construction of the work and may not make claims against the City for damages to materials and equipment from any cause except negligence or willful act of the City. Until its final acceptance, the Contractor shall be responsible for damage to or destruction of the project (except for any part covered by Partial Completion and Acceptance - Section 26). The Contractor shall make good all work damaged or destroyed before acceptance. All risk of loss remains with the Contractor until final acceptance of the work (Section 19) or partial acceptance (Section 26). The Contractor is advised to investigate obtaining its own builders risk insurance.

The Contractor shall guarantee the quality of the work for a period of one year. The Contractor shall also unconditionally guarantee the quality of all equipment and materials that are furnished and installed under the contract for a period of one year. At the end of one year after the Contractor's receipt of final payment, the complete work, including equipment and materials furnished and installed under the contract, shall be inspected by the Contractor and the Supervising Professional. Any defects shall be corrected by the Contractor at its expense as soon as practicable but in all cases within 60 days. Any defects that are identified prior to the end of one year shall also be inspected by the Contractor and the Supervising Professional and shall be corrected by the Contractor at its expense as soon as practicable but in all cases within 60 days.

The Contractor shall assign all manufacturer or material supplier warranties to the City prior to final payment. The assignment shall not relieve the Contractor of its obligations under this paragraph to correct defects.

Section 26 - Partial Completion and Acceptance

If at any time prior to the issuance of the final certificate referred to in Acceptance and Final Payment - Section 19, any portion of the permanent construction has been satisfactorily completed, and if the Supervising Professional determines that portion of the permanent construction is not required for the operations of the Contractor but is needed by the City, the Supervising Professional shall issue to the Contractor a certificate of partial completion, and immediately the City may take over and use the portion of the permanent construction described in the certificate, and exclude the Contractor from that portion.

The issuance of a certificate of partial completion shall not constitute an extension of the Contractor's time to complete the portion of the permanent construction to which it relates if the Contractor has failed to complete it in accordance with the terms of this Contract. The issuance of the certificate shall not release the Contractor or its sureties from any obligations under this Contract including bonds.

If prior use increases the cost of, or delays the work, the Contractor shall be entitled to extra compensation, or extension of time, or both, as the Supervising Professional may determine.

Section 27 - Payments Withheld Prior to Final Acceptance of Work

The City may withhold or, on account of subsequently discovered evidence, nullify the whole or part of any certificate to the extent reasonably appropriate to protect the City from loss on account of:

- (1) Defective work not remedied;
- (2) Claims filed or reasonable evidence indicating probable filing of claims by other parties

against the Contractor;

- (3) Failure of the Contractor to make payments properly to subcontractors or for material or labor;
- (4) Damage to another Contractor.

When the above grounds are removed or the Contractor provides a Surety Bond satisfactory to the City which will protect the City in the amount withheld, payment shall be made for amounts withheld under this section.

Section 28 - Contractor's Insurance

- (1) The Contractor shall procure and maintain during the life of this Contract, including the guarantee period and during any warranty work, such insurance policies, including those set forth below, as will protect itself and the City from all claims for bodily injuries, death or property damage which may arise under this Contract; whether the acts were made by the Contractor or by any subcontractor or anyone employed by them directly or indirectly. The following insurance policies are required:

- (a) Worker's Compensation Insurance in accordance with all applicable state and federal statutes. Further, Employers Liability Coverage shall be obtained in the following minimum amounts:

- Bodily Injury by Accident - \$500,000 each accident
- Bodily Injury by Disease - \$500,000 each employee
- Bodily Injury by Disease - \$500,000 each policy limit

- (b) Commercial General Liability Insurance equivalent to, as a minimum, Insurance Services Office form CG 00 01 07 98. The City of Ann Arbor shall be named as an additional insured. There shall be no added exclusions or limiting endorsements specifically for the following coverages: Products and Completed Operations, Explosion, Collapse and Underground coverage or Pollution. Further there shall be no added exclusions or limiting endorsements which diminish the City's protections as an additional insured under the policy. The following minimum limits of liability are required:

- \$1,000,000 Each occurrence as respect Bodily Injury Liability or Property Damage Liability, or both combined.
- \$2,000,000 Per Job General Aggregate
- \$1,000,000 Personal and Advertising Injury
- \$2,000,000 Products and Completed Operations Aggregate

- (c) Motor Vehicle Liability Insurance, including Michigan No-Fault Coverages, equivalent to, as a minimum, Insurance Services Office form CA 00 01 07 97. The City of Ann Arbor shall be named as an additional insured. There shall be no added exclusions or limiting endorsements which diminish the City's protections as an additional insured under the policy. Coverage shall include all owned vehicles, all non-owned vehicles and all hired vehicles. Further, the limits of liability shall be \$1,000,000 for each occurrence as respects Bodily Injury Liability or Property Damage Liability, or both combined.

- (d) Umbrella/Excess Liability Insurance shall be provided to apply excess of the Commercial General Liability, Employers Liability and the Motor Vehicle coverage enumerated above, for each occurrence and for aggregate in the amount of \$1,000,000.

- (2) Insurance required under subsection (1)(b) and (1)(c) above shall be considered primary as respects any other valid or collectible insurance that the City may possess, including any self-insured retentions the City may have; and any other insurance the City does possess shall be considered excess insurance only and shall not be required to contribute with this insurance. Further, the Contractor agrees to waive any right of recovery by its insurer against the City.
- (3) In the case of all Contracts involving on-site work, the Contractor shall provide to the City before the commencement of any work under this Contract documentation demonstrating it has obtained the above mentioned policies. Documentation must provide and demonstrate an unconditional 30 day written notice of cancellation in favor of the City of Ann Arbor. Further, the documentation must explicitly state the following: (a) the policy number; name of insurance company; name and address of the agent or authorized representative; name and address of insured; project name; policy expiration date; and specific coverage amounts; (b) any deductibles or self-insured retentions which shall be approved by the City, in its sole discretion; (c) that the policy conforms to the requirements specified. An original certificate of insurance may be provided as an initial indication of the required insurance, provided that no later than 21 calendar days after commencement of any work the Contractor supplies a copy of the endorsements required on the policies. Upon request, the Contractor shall provide within 30 days a copy of the policy(ies) to the City. If any of the above coverages expire by their terms during the term of this Contract, the Contractor shall deliver proof of renewal and/or new policies to the Administering Service Area/Unit at least ten days prior to the expiration date.
- (4) Any Insurance provider of Contractor shall be admitted and authorized to do business in the State of Michigan and shall carry and maintain a minimum rating assigned by A.M. Best & Company's Key Rating Guide of "A-" Overall and a minimum Financial Size Category of "V". Insurance policies and certificates issued by non-admitted insurance companies are not acceptable unless approved in writing by the City.

Section 29 - Surety Bonds

Bonds will be required from the successful bidder as follows:

- (1) A Performance Bond to the City of Ann Arbor for the amount of the bid(s) accepted;
- (2) A Labor and Material Bond to the City of Ann Arbor for the amount of the bid(s) accepted.

Bonds shall be executed on forms supplied by the City in a manner and by a Surety Company authorized to transact business in Michigan and satisfactory to the City Attorney.

Section 30 - Damage Claims

The Contractor shall be held responsible for all damages to property of the City or others, caused by or resulting from the negligence of the Contractor, its employees, or agents during the progress of or connected with the prosecution of the work, whether within the limits of the work or elsewhere. The Contractor must restore all property injured including sidewalks, curbing, sodding, pipes, conduit, sewers or other public or private property to not less than its original condition with new work.

Section 31 - Refusal to Obey Instructions

If the Contractor refuses to obey the instructions of the Supervising Professional, the Supervising Professional shall withdraw inspection from the work, and no payments will be made for work performed thereafter nor may work be performed thereafter until the Supervising Professional shall have again authorized the work to proceed.

Section 32 - Assignment

Neither party to the Contract shall assign the Contract without the written consent of the other. The Contractor may assign any monies due to it to a third party acceptable to the City.

Section 33 - Rights of Various Interests

Whenever work being done by the City's forces or by other contractors is contiguous to work covered by this Contract, the respective rights of the various interests involved shall be established by the Supervising Professional, to secure the completion of the various portions of the work in general harmony.

The Contractor is responsible to coordinate all aspects of the work, including coordination of, and with, utility companies and other contractors whose work impacts this project.

Section 34 - Subcontracts

The Contractor shall not award any work to any subcontractor without prior written approval of the City. The approval will not be given until the Contractor submits to the City a written statement concerning the proposed award to the subcontractor. The statement shall contain all information the City may require.

The Contractor shall be as fully responsible to the City for the acts and omissions of its subcontractors, and of persons either directly or indirectly employed by them, as it is for the acts and omissions of persons directly employed by it.

The Contractor shall cause appropriate provisions to be inserted in all subcontracts relative to the work to bind subcontractors to the Contractor by the terms of the General Conditions and all other contract documents applicable to the work of the subcontractors and to give the Contractor the same power to terminate any subcontract that the City may exercise over the Contractor under any provision of the contract documents.

Nothing contained in the contract documents shall create any contractual relation between any subcontractor and the City.

Section 35 - Supervising Professional's Status

The Supervising Professional has the right to inspect any or all work. The Supervising Professional has authority to stop the work whenever stoppage may be appropriate to insure the proper execution of the Contract. The Supervising Professional has the authority to reject all work and materials which do not conform to the Contract and to decide questions which arise in the execution of the work.

The Supervising Professional shall make all measurements and determinations of quantities. Those measurements and determinations are final and conclusive between the parties.

Section 36 - Supervising Professional's Decisions

The Supervising Professional shall, within a reasonable time after their presentation to the Supervising Professional, make decisions in writing on all claims of the City or the Contractor and on all other matters relating to the execution and progress of the work or the interpretation of the contract documents.

Section 37 - Storing Materials and Supplies

Materials and supplies may be stored at the site of the work at locations agreeable to the City unless specific exception is listed elsewhere in these documents. Ample way for foot traffic and drainage must be provided, and gutters must, at all times, be kept free from obstruction. Traffic on streets shall be interfered with as little as possible. The Contractor may not enter or occupy with agents, employees, tools, or material any private property without first obtaining written permission from its owner. A copy of the permission shall be furnished to the Supervising Professional.

Section 38 - Lands for Work

The Contractor shall provide, at its own expense and without liability to the City, any additional land and access that may be required for temporary construction facilities or for storage of materials.

Section 39 - Cleaning Up

The Contractor shall, as directed by the Supervising Professional, remove at its own expense from the City's property and from all public and private property all temporary structures, rubbish and waste materials resulting from its operations unless otherwise specifically approved, in writing, by the Supervising Professional.

Section 40 - Salvage

The Supervising Professional may designate for salvage any materials from existing structures or underground services. Materials so designated remain City property and shall be transported or stored at a location as the Supervising Professional may direct.

Section 41 - Night, Saturday or Sunday Work

No night or Sunday work (without prior written City approval) will be permitted except in the case of an emergency and then only to the extent absolutely necessary. The City may allow night work which, in the opinion of the Supervising Professional, can be satisfactorily performed at night. Night work is any work between 8:00 p.m. and 7:00 a.m. No Saturday work will be permitted unless the Contractor gives the Supervising Professional at least 48 hours but not more than 5 days notice of the Contractor's intention to work the upcoming Saturday.

Section 42 - Sales Taxes

Under State law the City is exempt from the assessment of State Sales Tax on its direct purchases. Contractors who acquire materials, equipment, supplies, etc. for incorporation in City projects are not likewise exempt. State Law shall prevail. The Bidder shall familiarize itself with the State Law and prepare its Bid accordingly. No extra payment will be allowed under this Contract for failure of the Contractor to make proper allowance in this bid for taxes it must pay.

Section 43

CONTRACTOR'S DECLARATION

I hereby declare that I have not, during the period _____, 20____, to _____, 20____, performed any work, furnished any materials, sustained any loss, damage or delay, or otherwise done anything in addition to the regular items (or executed change orders) set forth in the Contract titled _____, for which I shall ask, demand, sue for, or claim compensation or extension of time from the City, except as I hereby make claim for additional compensation or extension of time as set forth on the attached itemized statement. I further declare that I have paid all payroll obligations related to this Contract that have become due during the above period and that all invoices related to this Contract received more than 30 days prior to this declaration have been paid in full except as listed below.

There is/is not (Contractor please circle one and strike one as appropriate) an itemized statement attached regarding a request for additional compensation or extension of time.

Contractor

Date

By _____
(Signature)

Its _____
(Title of Office)

Past due invoices, if any, are listed below.

STANDARD SPECIFICATIONS

All work under this contract shall be performed in accordance with the Public Services Department Standard Specifications in effect at the date of availability of the contract documents stipulated in the Advertisement. All work under this Contract which is not included in these Standard Specifications, or which is performed using modifications to these Standard Specifications, shall be performed in accordance with the Detailed Specifications included in these contract documents.

A copy of the Public Services Department Standard Specifications may be purchased from the Engineering Division, (Fourth Floor, City Hall, Ann Arbor, Michigan), for \$35.00 per copy. In addition, a copy of these Standard Specifications is available for public viewing at the Engineering Division office, for review Monday through Friday between the hours of 8:30 a.m. and 4:00 p.m.

Copies of the Standard Specifications can also be downloaded from the web link:

http://www.a2gov.org/government/publicservices/project_management/privatedev/pages/standardspecificationsbook.aspx.

**DETAILED SPECIFICATION
FOR
PROJECT SCHEDULE**

Examination of Plans, Specifications, and Work Site

The work of this project shall be completed while maintaining traffic over the Treatment Plant Drive Bridge as described in the Detailed Specifications entitled "Maintenance of Traffic and Construction Sequencing" and "Hours of Work". The Contractor is expected to mobilize sufficient equipment and personnel and work the necessary overtime to complete the work within the timelines established herein. Bidders shall carefully examine the Bid Form, plans, specifications, and the work site until the Bidder is satisfied as to all local conditions affecting the contract and the detailed requirements of construction. The submission of the bid shall be considered prima facie evidence that the Bidder has made such examination and is satisfied as to the conditions to be encountered in performing the work and all requirements of the contract.

The entire work under this Contract shall be completed in accordance with, and subject to, the scheduling requirements as outlined below, and all other requirements of the Contract Documents.

1. The Contractor shall begin the work of this project immediately upon receipt of the fully executed Contract and Notice to Proceed.
2. The entire work under this contract, including, but not limited to, vegetation and tree removal and final restoration shall be completed within 70 calendar days from receipt of the Notice to Proceed.
3. The Contractor shall begin work on the tree removal for trees 3 inch in diameter or larger in the northwest, southwest, and northeast quadrants no sooner than **October 1, 2015**.

The Contractor shall be furnished with two (2) copies of the Contract, for his/her execution immediately after Council approves award in late August 2015. The Contractor shall properly execute both copies of the Contract and return them, with the required Bonds and Insurance Certificate, to the City within ten days of receiving Notice of Award from the City.. The Contractor shall not begin the work before the applicable date(s) as described herein, and in no case before the receipt of the fully executed Contract. City Council approval is expected in late August 2015.

**DETAILED SPECIFICATION
FOR
UTILITY COORDINATION AND
WORK BY OTHERS**

1 of 2

Utility Coordination

The following Utility Owners have facilities located within the Right-of-Way:

City of Ann Arbor (Sanitary Sewer)	Denny Zink	734-994-6450
AT&T	Andrew Johnson	734-996-5350
DTE Energy– Detroit Edison	Bruce Cady	313-330-0243
DTE Energy/Michcon	Tom Longo	586-463-3142
	Jim Fistler	313-389-7299
Comcast	Ron Southerland	313-999-8300
	Richard Ewasek	313-215-8082

On all projects: 3 working days before you dig- Call MISS DIG- Toll Free 1-800-482-7171

The Owners of public or private utilities which will not interfere with the completed project and which do not present a hazard to the public or an extraordinary hazard to the Contractor's operations will not be required to move their facilities on or from the street right-of-way.

No additional compensation will be paid to the Contractor for the delays due to material shortages or other reasons beyond the control of the City or the parties performing the work, or for delays to construction due to the encountering of existing utilities that are, or are not, shown on the plans. However, these delays may be considered as a basis for the request of an extension of contract time.

Work stoppages by employees of utility companies which results in a delay of utility revisions on any portion of this project may be considered the basis for a claim for an extension of time for project completion, but will not be considered the basis for a claim for extra compensation or an adjustment in contract unit prices.

Work By Others

The Contractor's attention is called to the requirement that AT&T will be performing work tasks related to the project including, but not limited to, relocating aerial telephone lines located south of Treatment Plant Drive onto the DTE poles located north of the roadway, parallel to the roadway and removal of wood utility poles in the southwest and southeast quadrants. The telephone lines laying on the ground in the southeast quadrant will also be removed. This relocation will take place prior to July 2015.

The Contractor is reminded as to the requirement of Cooperation by the Contractor as covered in Section 104.08 of the 2012 Michigan Department of Transportation Standard Specifications for Construction. No additional or extra compensation will be paid for any delays caused by AT&T. However, these delays may be considered as a basis for the request of an extension of contract time.

**DETAILED SPECIFICATION
FOR
UTILITY COORDINATION AND
WORK BY OTHERS**

2 of 2

Existing Utilities

The existing utilities, structures, features, and site conditions above and underground are shown on the Contract Drawings from the best available information. These include, but are not limited to, overhead lines, pipelines, conduits, and the like.

The Contractor shall wrap portions the existing 6-inch gas main attached to the south fascia beam with a heavy canvas to prevent damage to the gas main's protective coating during the cleaning and coating operations.

It is the Contractor's sole responsibility to perform his own site investigations and/or research and to incorporate in his bid necessary costs to insure that any extra costs arising from the work are planned for. If any utilities, structures, features and/or site conditions are discovered by the Contractor to be different than shown on the plans, as a result of the Contractor's investigations and/or research prior to the bid, the Contractor is obligated to notify the Engineer immediately in writing so an addendum may be issued and/or the bid date may be revised. In any case, no payments in excess of the bid price will be paid.

The Contractor is solely responsible for any delays, damages, costs and/or charges incurred due to and/or by reason of any utility, structure, feature, and/or site conditions whether shown on the plans or not, and the Contractor shall repair and/or replace, at his sole expense, to as good or better condition, any and all utilities, structures, features and/or site conditions which are impacted by reason of the work or injured during the operation of his subcontractors or suppliers.

No extra payments or adjustments to unit prices will be made for damages, delays, costs and/or charges due to existing utilities, structures, features and/or site conditions not shown, or being incorrectly shown or represented on the Plans.

**DETAILED SPECIFICATION
FOR
NOTICE TO BIDDERS**

The City reserves to the right to increase or decrease plan quantities and eliminate items of work as necessary due to budgetary constraints without adjustment to the quoted unit and lump sum prices as bid by the Contractor.

The Michigan Department of Environmental Quality (MDEQ) Waste and Hazardous Materials Division Site Identification Number will be applied for by the Wastewater Treatment Plant and supplied to the Contractor upon receipt.

**DETAILED SPECIFICATION
FOR
MAINTENANCE OF TRAFFIC
AND CONSTRUCTION SEQUENCING**

1 of 3

Description.

This work will consist of bridge repairs on Treatment Plant Drive over Huron River in the City of Ann Arbor, at the Wastewater Treatment Plant (WWTP) entrance. The bridge is a single lane bridge which provides the only access into and out of the WWTP.

This work shall be performed in accordance with the City of Ann Arbor Public Services Department Standard Specifications and as specified in Section 812 of the 2012 Michigan Department of Transportation (MDOT) Standard Specifications for Construction including any Supplemental Specifications and Special Provisions, the 2011 Michigan Manual of Uniform Traffic Control Devices (MMUTCD), and as specified in the proposal.

The Contractor shall furnish, erect, maintain and, upon completion of the work, remove all traffic control devices and barricades within the project and around the perimeter of the project for the safety and protection of local traffic.

General.

Refer to the Detailed Specification entitled "Hours of Work" for allowed work windows. The work windows described are the only allowed time periods when the Contractor can prohibit vehicular movements into and out of the WWTP. This phase of construction is referred in the plans as Stage II. If access over the bridge is prohibited, Stage II signs and barricades must be in place. These time windows are subject to change. In the case of an emergency, the Contractor shall provide access over the bridge as directed by the Engineer.

Stage I refers to periods of time when the Contractor is present on the project site, but access over the bridge remains open. Stage I signs are detailed in the plans.

Materials.

The materials and equipment shall meet the requirements specified in the corresponding sections of the MDOT 2012 Standard Specifications for Construction, the 2011 MMUTCD.

Separate pay items are provided in the contract to compensate for the traffic maintenance outlined in this special provision. All other costs due to traffic maintenance are the responsibility of the Contractor.

Barricades necessary for traffic control and public safety shall be furnished and erected by the Contractor as shown on the plans. The barricades shall be lighted as shown in the 2012 MDOT Standard Specifications for Construction and the 2011 MMUTCD and per the MDOT Traffic and Safety Standards Plan WZD-125-E. Type III Barricades shall be supplemented with three (3) Type C warning lights. The warning signs required at Type III Barricade locations shall be mounted above the barricade on separate sign supports.

The Contractor shall furnish and install all signing necessary for the maintenance of traffic. All signs shall conform to the 2011 MMUTCD. Construction warning signs in use during daylight hours shall be supplemented with a minimum of two (2) fluorescent warning flag. Signs in use during hours of darkness shall be lighted with at least two (2) Type A warning flashers. Posts shall be ground driven, refer to MDOT Maintaining Traffic Typical WZD-100-A.

**DETAILED SPECIFICATION
FOR
MAINTENANCE OF TRAFFIC
AND CONSTRUCTION SEQUENCING**

2 of 3

Traffic Restrictions.

Work hours and restrictions shall conform with the Detailed Specification entitled "Hours of Work". There are no holiday restrictions on this project.

Measurement and Payment.

Temporary traffic control items have been set up for maintenance of traffic during construction zone operations and shall be measured and paid for in accordance with Section 812 of the 2012 MDOT Standard Specifications for Construction including any Supplemental Specifications and Special Provisions. Payment for quantities used to maintain traffic will be based on the maximum number of units required by the Engineer at any one time for the entire project.

Pay Item	Pay Unit
Barricade, Type III, High Intensity, Lighted, Furn	Each
Barricade, Type III, High Intensity, Lighted, Oper	Each
Sign, Type B, Temp, Prismatic, Furn	Sft
Sign, Type B, Temp, Prismatic, Oper	Sft
Sign, Type B, Temp, Prismatic, Special, Furn	Sft
Sign, Type B, Temp, Prismatic, Special, Oper	Sft

This work includes all labor, equipment, and materials necessary to furnish and operate traffic control devices for the duration of the project.

DETAILED SPECIFICATION FOR MAINTENANCE OF TRAFFIC AND CONSTRUCTION SEQUENCING

3 of 3

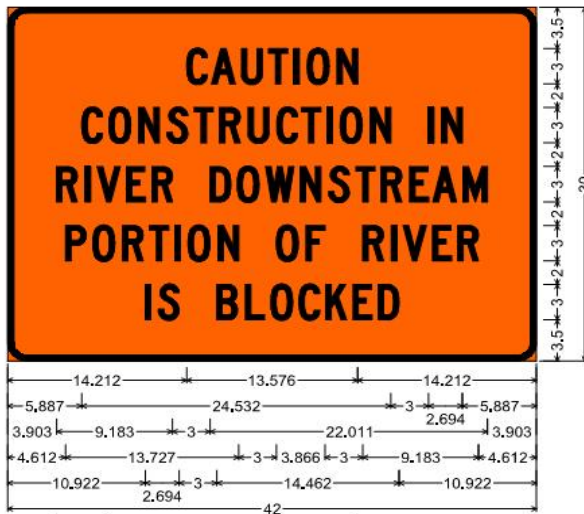

Special Detail: 1,500" Radius, 0,500" Border, Black on Orange;
 "CAUTION" C; "CONSTRUCTION IN" C; "RIVER DOWNSTREAM" C;
 "PORTION OF RIVER" C; "IS BLOCKED" C;

Table of widths and spaces,

14.212	C	1.640	0.340	A	1.875	0.507	U	1.641	0.506	T	1.500	0.507	I	0.422	0.632	D	1.734	0.632	N	1.640	14.212																	
5.887	C	1.641	0.506	O	1.735	0.631	N	1.641	0.632	S	1.640	0.507	T	1.500	0.507	R	1.640	0.632	U	1.641	0.631	C	1.641	0.340	T	1.500	0.507	I	0.421	0.632	O	1.734	0.632	N	1.641			
3.903	I	0.422	0.631	N	1.641	5.887																																
3.000	R	1.641	0.632	I	0.421	0.507	V	1.828	0.507	E	1.500	0.507	R	1.640																								
3.903	D	1.641	0.506	O	1.735	0.507	W	2.250	0.506	N	1.641	0.631	S	1.641	0.507	T	1.500	0.506	R	1.641	0.632	E	1.500	0.340	A	1.875	0.506	M	1.946	3.903								
4.612	P	1.640	0.507	O	1.734	0.632	R	1.641	0.506	T	1.500	0.507	I	0.422	0.632	O	1.734	0.632	N	1.640																		
3.000	O	1.735	0.631	F	1.500																																	
3.000	R	1.641	0.632	I	0.421	0.507	V	1.828	0.507	E	1.500	0.507	R	1.640	4.612																							
10.922	I	0.422	0.632	S	1.640																																	
3.000	B	1.641	0.631	L	1.500	0.507	O	1.734	0.507	C	1.641	0.506	K	1.641	0.507	E	1.500	0.506	D	1.641	10.922																	

**DETAILED SPECIFICATION
FOR
HOURS OF WORK**

Due to the location of this project, Ann Arbor City Code Title IX, Chapter 106, PP. 9.13 **will not** be applicable which limits work to Monday through Saturday, between the hours of 7:00a.m. and 8:00p.m.

No parking on access road into the Wastewater Treatment Plant will be permitted from 7:00a.m. to 6:00 p.m., Monday through Friday. No storage or equipment will be permitted on the access road when the Contractor is not present.

No bridge or access road restrictions greater than 10 minutes in length will be permitted from 5:00a.m. to 9:15p.m., Monday through Friday (referred to as Stage I).

No bridge or access road restrictions will be permitted from 5:00a.m. to 5:10a.m., 6:45a.m. to 7:10a.m., 8:45a.m. to 9:10a.m., 5:00p.m. to 5:10p.m., 6:45p.m. to 7:10p.m. and 8:45 p.m. to 9:10 p.m. on Saturday and Sunday.

Depending on weather, access road use may become necessary on Saturday from 5:00a.m. to 9:15p.m.. Two days advance notice will be provided to the Contractor if additional Saturday traffic restrictions are required.

In the case of an emergency, the Contractor shall provide immediate access over the bridge as needed by emergency responders.

Reference the Detailed Specification entitled "Maintenance of Traffic and Construction Sequencing" for coordination.

**DETAILED SPECIFICATION
FOR
OFFICE AND STORAGE**

The Contractor may establish and maintain, at his own expense, office headquarters at the site of the work and such storage space and the like as may be required.

A Contractor staging area for an office, materials, equipment, storage parking and the like is available in the southeast quadrant of the project as detailed on the plans.

Any materials placed to level the staging area or access into the area shall be at the Contractor's expense. Surface drainage must be maintained. Restoration of the staging area will be paid for as part of this contract as Slope Restoration. Payment for Slope Restoration shall not exceed plan quantity. Payment for restoration exceeding this area will be the Contractor's sole expense.

Prior to erection of any temporary buildings, the Contractor shall submit plans to the City's representative for general approval of materials and appearance.

No power or telephone hook-up is available.

Burning or burying on the site of any materials will NOT be permitted.

Handling and storage of flammable liquids and all other toxic or dangerous chemicals shall comply with all safety regulations and codes pertaining thereto.

Trash removal is available daily.

The Contractor may store materials on-site for future incorporation into the work entirely at his own risk until the work is accepted in its entirety by the City.

Storage practice and location shall be subject to the Engineer's inspection and approval.

The Contractor shall remove all temporary facilities provided by him at the termination of their usefulness or the termination of the work, or when requested, and shall leave the premises in a condition as good, or better than, that which existed prior to the beginning of work by the Contractor. Reference the Detailed Specification entitled "Slope Restoration" for time limitations on installing turf restoration and/or stabilization materials, including topsoil, fertilizer, seed, mulch, mulch anchoring, and mulch blankets to the staging area in accordance with 2012 Michigan Department of Transportation (MDOT) Standard Specifications for Construction Section 208.

**DETAILED SPECIFICATION
FOR
PROPERTY MARKERS/MONUMENTS**

The Contractor shall take precautions not to move or destroy any monuments or stakes marking the boundaries of property along or near the work. The Contractor shall notify the Engineer in sufficient time so property markers and monuments may be properly protected or witnessed for later replacement by the Engineer. If a property marker, monument, or the like are disturbed or damaged by the Contractor, they shall be re-set by the City at the Contractor's sole expense.

**DETAILED SPECIFICATION
FOR
MIGRATORY BIRD PROTECTION**

1 of 3

Description.

Contractors are advised that bridges and large culverts similar to those in this project are often attractive places for nesting birds such as swallows and phoebes. Burrow nesting species (swallows and the Belted Kingfisher) may also take advantage of banks created during earth-moving or soil storage, making it necessary to prevent excavation of new nesting burrows. Taking of migratory birds or nests with eggs and chicks without a federal permit is prohibited by the Migratory Bird Treaty Act (16 U.S.C. 703-712). This federal law protects migratory birds, their nests and young, and provides enforcement authority to the U.S. Fish and Wildlife Service and contains severe penalties for violations. Adherence to these provisions by the FHWA is required under Federal law. This detailed specification addresses the actions required of the Contractor to protect the above mentioned bird species as required by the Migratory Bird Treaty Act.

Construction. Adhere to the following requirements:

1. Bridge Work - April 15 to September 1.

A. Bridge work done entirely on the deck: No special action is necessary by the Contractor provided that the work is done entirely on the deck. It is presumed that the Contractor will not require access to areas where birds are nesting and contract work will not result in the disturbance of nesting adults, or to their eggs or young due to vibrations from equipment or other construction activity.

B. Work done entirely on the deck that would result in perforation of the deck or create strong vibrations. Activities that would potentially dislodge nests beneath the deck will require that the Contractor use exclusionary devices to deter birds from nesting beneath the bridge deck prior to start of work. If birds are present, the Contractor must determine the status of the migratory birds, their nests, and young and must take any and all special actions to meet the requirements of the Migratory Bird Treaty Act.

C. Bridge work requiring activity above and below the deck: This is the anticipated active nesting period of most migratory birds; though later dates may apply in the Upper Peninsula. Prior to commencing work within this time frame, or continuing work which will carry over into this time frame the following year, the Contractor must determine the status of the migratory birds, their nests, and young and must take any and all special actions to meet the requirements of the Migratory Bird Treaty Act.

2. Bridge Work - September 2 to April 14. During this time, birds are normally not nesting; therefore, no special actions by the Contractor are necessary after an inspection is conducted to determine if birds are present.

**DETAILED SPECIFICATION
FOR
MIGRATORY BIRD PROTECTION**

2 of 3

THE FOLLOWING DISCUSSION PRESENTS MINIMUM REQUIREMENTS AND IS NOT TO BE CONSTRUED AS A COMPLETE LIST OF POSSIBLE ACTIONS REQUIRED TO COMPLY WITH THE ACT.

Status of Birds and Nests - Bridges.

1. If existing nests are not occupied or no new nests have been built: Barriers (deterrents) must be installed before the nesting season to prevent nest establishment or reuse. Netting, canvas, plastic sheeting, or burlap must be used. Different techniques may be employed, depending on the design of the bridge, providing that reasonable access is maintained for traffic under the bridge, if needed. Netting can be “diapered” around all ledges and overhangs to insure access to any potential nesting site is obstructed. Other bridge designs may lend themselves to hanging netting, canvas, or burlap over the side of a bridge. Some device, such as a wooden beam can be employed to secure the bottom edge of the netting, canvas, plastic sheeting, or burlap close to the water or ground surface. All gaps must be sealed against entry by birds. Any protective devices that become displaced must be repositioned within 8 hours.
2. If birds penetrate the barrier and/or nest building has commenced: If birds slip past the installed deterrents, the Contractor must determine how birds are entering the underside of the bridge and adjust or repair the barrier to prevent further access. If nest building or repair of existing nests has begun, but no eggs or chicks are present in the nests based upon visual inspection of the nest cup, the Contractor must knock down or hose down nests with water or by other means.
3. If nests with eggs and chicks are accidentally knocked down: Every effort must be made by the Contractor not to cause a take of eggs or chicks. Taking of migratory birds or nests with eggs or chicks is prohibited by law without a federal permit. If exclusionary devices have not been erected or have not been maintained allowing for the completion and use of nest sites, no work can be conducted until cleared by the Engineer. If eggs or chicks are accidentally dislodged due to work being performed on the bridge deck (as per subsection c.1), the Contractor must deliver retrieved eggs and chicks to a licensed wildlife rehabilitation facility willing and able to accept them (contacts can be found on the MDNR website). If this occurs, the Contractor must immediately contact the Engineer.
4. Nests with eggs or young are present prior to the start of contract work: If active nests with eggs or young are found that would be affected by construction activities, work must be delayed until an evaluation of nesting status is made or the birds fledge from the nest and leave the immediate area.

Earthwork.

1. Earthwork - April 15 to September 1. If there are existing banks, conduct an inspection to determine if nest burrows or birds are present. If banks are created in sand or gravel or in soil storage piles during construction several species of birds may begin to excavate burrows to be used for nesting. Banks with a vertical face greater than 4 feet are attractive to these species. Inspect the banks and report possible nesting activity to the Engineer. If burrow excavation has just begun and observation shows that no eggs or young are present, the banks should be knocked down to a natural angle of repose. If the bank needs to be maintained in its existing condition, plastic sheeting or other materials should be draped over the area to prohibit entry by the birds. If burrows are too deep to determine if

**DETAILED SPECIFICATION
FOR
MIGRATORY BIRD PROTECTION**

3 of 3

eggs or young are present by visual inspection, work that would affect the stability and/or destruction of the bank should be stopped and the Engineer should be contacted for further direction.

2. Earthwork - September 2 to April 14. During this time, birds are normally not nesting; therefore, no special actions by the Contractor are necessary after an inspection is conducted to determine if birds are present.

Measurement and Payment.

All costs for determining the need for, the placing of deterrents, and applying of all special actions including, but not limited to, removing nests, retrieving dislodged eggs and chicks and delivering them to a licensed wildlife rehabilitation center, including costs of rehabilitation, and any and all costs associated with conducting work in compliance with the Migratory Bird Treaty Act as stated herein will not be paid for separately but will be considered to have been included with other items of work.

In addition, the Contractor is liable to the City for any penalties imposed for violations to the Migratory Bird Treaty Act due to the Contractor's failure to comply with this specification. Penalties range from fines per each incident up to potential loss of Federal funding. According to the Act, a person, association, partnership or corporation which violates the Act or its regulations is guilty of a misdemeanor and subject to a fine of up to \$500, jail up to 6 months, or both. Anyone who knowingly takes a migratory bird and intends to, offers to, or actually sells or barter the bird is guilty of a felony, with fines up to \$2000, jail up to 2 years, or both.

**DETAILED SPECIFICATION
FOR
PROVIDING EXPOSURE ASSESSMENTS, EXPOSURE MONITORING, EQUIPMENT,
HYGIENE FACILITIES, AND TRAINING**

1 of 2

Description.

Provide exposure assessments, exposure monitoring, equipment, hygiene facilities, and training as required by Part 603 Lead Exposure in Construction, of the MIOSHA, to all of the Contractor's employees, FHWA employees, MDOT employees, and to employees of Local Agencies who are acting as inspectors or project managers on any bridge painting projects or on any bridge repair or removal projects where welding, burning, or abrasive blasting of structural steel is being performed. This also applies to all construction work where an employee may be occupationally exposed to lead. The Contractor is responsible for requiring their employees to wear equipment and to use facilities provided by the Contractor; and for providing exposure assessments, exposure monitoring, equipment, hygiene facilities, and training in accordance with Part 603 Lead Exposure in Construction.

Equipment and Facilities.

Provide the employee(s) protective clothing and equipment, change areas, showers, eating facilities, and hand and face washing facilities as required by MIOSHA's Part 603 Lead Exposure in Construction. The equipment and facilities must be on site and fully functional prior to beginning any blast cleaning. Until the Contractor performs an employee exposure assessment and determines actual employee exposure for each job classification, the Contractor must provide to employee all items listed above plus respiratory protection, which must include the respirator, respirator training and fit testing, and a respirator program. Depending on the tasks, the Contractor must provide the appropriate respiratory protection until such time that exposure assessments results are complete. For manual operations, the respirator protection provided to the employee(s) must be based on anticipated (presumed) exposure levels greater than the Permissible Exposure Limit (PEL) (50 µg/m³), but less than 10 times the PEL (500 µg/m³). Provide the employee(s), at a minimum, with a half mask air purifying respirator with high efficiency particulate (HEPA) filters, which provides a respiratory protection factor of 10. For tasks such as rivet busting, or power tool cleaning without dust collection systems, the anticipated (or presumed) exposure assessment must be between 10 to no more than 50 times the PEL which requires a higher level of respiratory protection. For tasks such as abrasive blasting or torch cutting, the anticipated exposure assessment must be more than 50 times the PEL. If, through employee exposure assessment, the Contractor determines the actual employee exposure level, then the appropriate respiratory protection can be provided. Provide the employee(s) with protective clothing and equipment, change areas, and hand and face washing facilities as required by MIOSHA's Part 1, General Rules or other relevant safety standards, for removal of non lead containing coatings.

Exposure Assessment.

At a minimum, the Contractor must collect personal samples representative of a full shift including at least one sample for each job classification in each work area either for each shift or for the shift with the highest exposure level. Conduct the initial exposure assessment and any additional exposure assessments, and report the results in accordance with Part 603.

Document the results of the employee exposure assessment(s) on the attached 'Lead Exposure Record' or another Contractor supplied form that reports the exact same pieces of data. The results of the employee exposure assessment(s) must be determined and reported in periods consistent with Part 603.

**DETAILED SPECIFICATION
FOR
PROVIDING EXPOSURE ASSESSMENTS, EXPOSURE MONITORING, EQUIPMENT,
HYGIENE FACILITIES, AND TRAINING**

2 of 2

Training.

Train all employees who are subject to exposure to lead and train employees as designated by FHWA, MDOT, or the Local Agency. Provide the following information at the preconstruction meeting:

1. Name and qualifications of the trainer,
2. Location and time of the training, and
3. An outline of the training to be provided.

Provide each employee with a certificate of training and a wallet card. Present a copy of the certificate or wallet card upon request.

Measurement and Payment.

The completed work for Providing Exposure Assessments, Exposure Monitoring, Equipment, Hygiene Facilities, and Training will be considered included in the pay item **Steel Structure, Cleaning, Partial, Type 4, Pier/Abutment** or **Steel Structure, Cleaning, Type 4, Pier/Abutment** or in any associated structural removal pay items with steel beams.

**DETAILED SPECIFICATION
FOR
GRANULAR MATERIALS**

Section 902.07 of the 2012 Michigan Department of Transportation (MDOT) Standard Specifications for Construction shall be deleted in its entirety and replaced with the following:

Granular Materials, if required, as fill at the temporary support location(s) must consist of geologically natural sand, gravel, or crushed stone. The use of iron furnace blast slag or reverberatory furnace slag is prohibited. The grading requirements of all granular materials shall conform to the requirements of Table 902-3 in the 2012 MDOT Standard Specifications for Construction.

**DETAILED SPECIFICATION
FOR
CLEARING, SPECIAL**

Description.

This work consists of cutting, removing and disposal of brush, shrubs, vegetation, logs and trees within the horizontal clearing area shown on the plans and as described in Sections 201 and 202 of the 2012 Michigan Department of Transportation (MDOT) Standard Specifications for Construction, except as modified herein.

Work consisting of tree removal 3 inches in diameter and greater must be completed after October 1, 2015, and prior to March 31, 2016, due to the possible existence of federally protected bat species within the project area. Tree removal performed outside of these dates will not be paid for and may subject the Contractor to penalties and additional costs, including assessment of liquated damages and being held in default of contract.

In the northwest, northeast and southwest quadrants of the bridge, trees six inches in diameter and greater shall be cut within 6 inches of the existing grade, removed and disposed of as described in Section 201. Application of growth preventive materials shall be applied the same day the trees are cut down. Brush, shrubs, vegetation, or like growth, less than 6 inches in diameter, shall be cut within 6 inches of the existing grade, removed and disposed of off-site as described in Section 201.

In the southeast quadrant, trees 3 inches in diameter and greater have been cut, removed and disposed of. The Contractor is responsible for cutting, removing and disposing of all brush, tree stumps and rocks as required to use this area for river access and staging. Stumps and roots located in the southeast corner of bridge near the wingwall, and located behind the guardrail, near the light pole, shall be removed and disposed of in their entirety off-site.

Materials.

Growth preventive materials shall be in accordance with Section 201.02 of the 2012 MDOT Standard Specifications for Construction.

Construction.

Construction work shall be in accordance with Sections 201 and 202 of the 2012 MDOT Standard Specifications for Construction as modified herein.

Measurement and Payment.

The completed work, as described, will be measured and paid for at the contract unit price using the following pay item:

Pay Item	Pay Unit
Clearing, Special	Square Yard

Clearing, Special includes all labor, equipment and materials necessary to cut, remove and dispose of brush, shrubs, rocks, vegetation and trees, and apply growth preventative materials as described above. Tree stumps and roots shall be removed and disposed of off-site at the two locations noted above. Tree locations provided on the plans do not represent all trees to be removed within the clearing limits.

**DETAILED SPECIFICATION
FOR
STRUCTURES, REM PORTIONS, SPECIAL**

Description.

This work consists of removing and disposing of timber debris located upstream of the pier and as described in Section 204 of the 2012 Michigan Department of Transportation (MDOT) Specifications for Construction as modified herein.

Materials.

None.

Construction.

Contractor shall remove and dispose of timber debris off-site in accordance with Section 204 of the 2012 MDOT Standard Specifications for Construction.

Measurement and Payment.

The completed work, as described, will be measured and paid for at the contract unit price using the following pay item:

Pay Item	Pay Unit
Structures, Rem Portions, Special	Lump Sum

Structures, Rem Portions, Special includes all labor, equipment and materials necessary to remove and dispose of timber debris located upstream of the pier.

**DETAILED SPECIFICATION
FOR
STEEL STRUCTURE, CLEANING, PARTIAL, TYPE 4, ___
STEEL STRUCTURE, COATING, PARTIAL, TYPE 4, ___**

Description.

This work consists of cleaning and coating of structural steel two feet from the beam end and steel bearings located at the abutments and piers and as described in Section 715 of the 2012 Michigan Department of Transportation (MDOT) Specifications for Construction and modified herein.

Materials.

Provide cleaning and coating materials meeting the requirements specified in Section 915 of the 2012 MDOT Standard Specifications for Construction.

Construction.

Conduct all work in accordance with Section 715 of the 2012 MDOT Standard Specifications for Construction except as modified on the plans and herein.

Measurement and Payment.

The completed work, as described, will be measured and paid for at the contract unit price using the following pay item:

Pay Item	Pay Unit
Steel Structure, Cleaning, Partial, Type 4, Pier	Square Foot
Steel Structure, Coating, Partial, Type 4, Pier	Square Foot
Steel Structure, Cleaning, Partial, Type 4, Abutment	Square Foot
Steel Structure, Coating, Partial, Type 4, Abutment	Square Foot

Steel Structure, Cleaning, Partial, Type 4, ___ and Steel Structure, Coating, Partial, Type 4, ___ includes all labor, equipment and materials necessary to clean and coat the three structural steel beams and steel bearings at the abutments or pier.

The Contractor shall provide access to cleaning and coating areas for the purpose of construction observation and testing services.

**DETAILED SPECIFICATION
FOR
COFFERDAMS**

1 of 2

Description.

This work consists of designing, furnishing, installing, maintaining and removing a cofferdam around the pier, and dewatering as required, to patch the pier and install scour countermeasures upstream of the pier, as shown on the plans or as approved by the Engineer. Complete the work in accordance with the 2012 Michigan Department of Transportation (MDOT) Standard Specifications for Construction, this detailed specification and Michigan Department of Environmental Quality (MDEQ) Permit Number 15-81-0007-P.

The work includes installing, maintaining and removing a Portadam™ cofferdam dewatering system as described herein, or an approved equal. If an alternative system is proposed, the Engineer shall have two weeks to review the alternative system.

Materials.

Install, maintain and remove a Portadam™ cofferdam dewatering system with a maximum height of 12 feet, required to be installed in a single phase in order to perform bridge pier patching, placement of grout filled bags in a scour hole upstream of the pier, and installation and removal of temporary beam end support columns and foundations (as needed). Place Engineered steel support frames with a continuous, impervious, fabric membrane to retain the Huron River. The cofferdam construction shall allow all work on and around the pier to be completed in-the-dry. Construct cofferdams with interior clearances to complete work on and around the pier and for the placement of temporary supports, as needed. Place sandbags along the system as required and directed by the technical labor assistance from Portadam™ and the Engineer. Pumps shall be used to control groundwater, seepage, overflow and precipitation within the cofferdam. Water shall be discharged from inside the cofferdam into a basin or approved device to prevent suspended materials from directly entering the Huron River.

Portadam™ contact information:
Monte Hickman
Sales Manager
3082 South Black Horse Pike
Williamstown, NJ 08094
Phone: 856-740-0606 ext 204
Fax: 856-740-0614
mhickman@portadam.com
www.portadam.com

If another cofferdam system is used, materials and Contractor provided working drawings and design calculations must be approved by the Engineer in accordance with the 2012 MDOT Standard Specifications for Construction.

Place reflective marking tape on the upstream end of the cofferdam as detailed on the plans to alert river users.

**DETAILED SPECIFICATION
FOR
COFFERDAMS**

2 of 2

Construction.

On-site technical and labor assistance shall be provided by Portadam™ during installation and removal of the cofferdam system and shall continue throughout the installation and removal process.

Erection of the cofferdam shall not be made during high-water events as directed by the Engineer.

The Contractor shall provide access to and within the cofferdam for purpose of construction observation and testing services.

Reflective marking tape shall be placed on the upstream end of the cofferdam after erection and remain in place for the duration of the cofferdam. Locations will be approved by the Engineer.

The Contractor shall submit working drawings and design calculations for the cofferdams that are prepared and sealed by a professional engineer, licensed in the State of Michigan, competent in geotechnical and structural engineering.

For each submittal or re-submittal, the Contractor shall allow at least 14 calendar days from the date of the submittal to receive the Engineer's acceptance or request for revisions. The Engineer's comments shall be incorporated into the submitted working drawings, calculations and descriptions. The Engineer's acceptance is required before beginning the work. Re-submittals shall be reviewed and returned to the Contractor within 14 calendar days. Required revisions will not be a basis of payment for additional compensation, extra work, or an extension of contract time. The Contractor shall include time for this entire review process in his/her CPM network schedule.

Measurement and Payment.

The completed work, as described, will be measured and paid for at the contract unit price using the following pay item:

Pay Item	Pay Unit
Cofferdams.....	Lump Sum

Payment for Cofferdams includes the preparation of all working drawings and design calculations, and all labor, equipment and materials necessary to install, and remove when no longer needed, a temporary cofferdam dewatering system around the pier as detailed on the plans, working drawings and design calculations, and as outlined in this detailed specification.

**DETAILED SPECIFICATION
FOR
BRIDGE LIGHTING, FURN AND OPER**

Description.

This work consists of furnishing, operating, maintaining and removing lighting required for night work and as described in Section 706 of the 2012 Michigan Department of Transportation (MDOT) Specifications for Construction and modified herein.

Materials.

Night work shall be lighted to an average intensity of 10 foot-candles minimum. Sufficient light sources shall be provided to achieve this illumination requirement.

Construction.

The lighting scheme shall be submitted to the Engineer for review and approval a minimum of 72 hours prior to the anticipated commencement of nighttime work. Nighttime work will not be allowed to begin until such time as the lighting scheme has been approved by the Engineer.

The lighting shall allow the inspector to clearly see and inspect all work operations. Light sources shall be adjusted as directed by the Engineer, as many times as needed, in order to meet the requirement.

Lighting systems may be fixed, portable, or equipment mounted. A power source shall be supplied with sufficient capacity to operate the lighting system. The lighting system(s) shall be arranged such that they do not interfere with the vision of motorists, glare or shine in the eyes of oncoming drivers, or unnecessarily illuminate surrounding properties or residences. After initial set-up, drive through and observe the lighted area from each direction on the roadway. Adjust lighting units as many times as needed in order to comply with these requirements.

Measurement and Payment.

The completed work, as described, will be measured and paid for at the contract unit price using the following pay item:

Pay Item	Pay Unit
Bridge Ltg, Furn and Oper	Lump Sum

Bridge Ltg, Furn and Oper includes all labor, equipment and materials necessary to furnish, operate, maintain and remove lighting as required to safely perform night work. Reference the Detailed Specification entitled "Hours of Work" for coordination.

**DETAILED SPECIFICATION
FOR
CLEANING BRIDGE JOINT**

Description.

This work consists of cleaning the existing bridge deck expansion joint prior to substantial project completion. Perform all work and provide all materials in accordance with this detailed specification.

Materials.

None.

Construction.

Clean joint faces and existing neoprene joint seal with compressed water to obtain a joint free of oil, grease, and debris. Clean with a minimum pressure of 90 psi.

Measurement and Payment.

The completed work as described will be paid for at the contract unit price for the following contract item (pay item):

Pay Item	Pay Unit
Cleaning Bridge Joint	Foot

Payment for Cleaning Bridge Joint includes all labor, equipments and materials necessary to clean the existing joint.

**DETAILED SPECIFICATION
FOR
ABUTMENT CRACK REPAIR**

1 of 2

Description.

This work consists of repairing cracks at the abutments by pressure injection as described in Section 712 of the 2012 Michigan Department of Transportation (MDOT) Standard Specifications for Construction as modified herein, and per the requirements of this detailed specification.

Materials.

A polyurethane hydrophobic grout shall be placed in lieu of the epoxy grout specified in MDOT's Standard Specifications for Construction.

Approved grout products for underwater injection include:

<u>Company</u>	<u>Product</u>
Sika	Sikadur-53
Euclid	Aquaseal Epoxy Systems
Denso	SeaShield 530
Five-Star Marine	Underwater Epoxy Gel

A watertight, temporary, non-staining sealant shall be placed along the entire length of the vertical abutment cracks. The sealant shall extend beyond the width of the crack a minimum of 2" on each side.

Construction.

The temporary sealant shall extend the full height of the vertical crack. A certified diver using Self-Contained Underwater Breathing Apparatus (SCUBA) shall perform vacuum dredging to expose the end of the crack, which visually terminates at the river bottom. The diver shall install the temporary sealant below the water line to the crack termination or top of abutment footing.

All injection grouting procedures shall be performed in accordance with the 2012 MDOT Standard Specifications for Construction and per manufacturer's recommendations as approved by the Engineer. For work below the waterline, a certified diver shall install injection ports, injection grout, and fill injection port holes with sealant, flush with the concrete surface.

Measurement and Payment.

The completed work, as described, will be measured and paid for at the contract unit price using the following pay item:

Pay Item	Pay Unit
Abutment Crack Repair.....	Feet

**DETAILED SPECIFICATION
FOR
ABUTMENT CRACK REPAIR**

2 of 2

Abutment Crack Repair includes all labor (including a certified diver), equipment and materials necessary for pressure injection of vertical cracks at the bridge abutments. This work includes, but is not limited to: vacuum dredging, temporary sealant placement, installation and removal of all injection ports, injection grouting the cracks, and filling injection port holes with sealant, flush with the concrete surface.

The Contractor shall provide access to abutment crack repair areas for the purpose of construction observation.

**DETAILED SPECIFICATION
FOR
PIER CRACK REPAIR**

1 of 5

Description.

Work covered under this section consists of microfine cementitious injection grouting of cracks in the bridge pier. Repair cracks beginning at the base of the pier working vertically upward to the bearing point in accordance with these specifications.

The Contractor shall furnish all materials, tools, equipment, appliances, transportation, labor and supervision required to inject micro-fine cementitious grout in foundation pier cracks to stop water infiltration and seal the cracks. Cracks to be sealed are detailed on the Substructure Repair Details Sheet. Repairs shall be performed by the injection of micro-fine cementitious grout materials as specified in the Product Section herein.

References.

- A. Materials and construction methods shall follow the practice defined by the following standard specifications unless otherwise specified:
1. ACI 546R-14 "Concrete Repair Guide"
 2. ACI 546.3R-14 "Guide for the Selection of Materials for the Repair of Concrete"
 3. EM 1110-2-2002 - US Army Corps of Engineers, "Engineer Manual, Maintenance and Repair of Concrete and Concrete Structures"

Qualifications.

A. Applicator's Qualifications:

1. Grout injection shall be performed by an applicator using a nationally known and recognized injection process. The applicator shall submit a statement regarding previous experience in performing comparable work. The statement shall include a summary record of previous injection projects.

B. Workman's Qualifications:

Contractor's foreman responsible for the injection process shall have satisfactorily completed a program of instruction in the methods of restoring concrete structures, utilizing the specific injection method proposed. The curriculum shall include theory on the nature and causes of cracking in concrete, methods for permanently repairing damaged concrete structures, the technical aspects of correct material selection and use, and the operation, maintenance and trouble shooting of equipment.

1. Applicator's superintendent shall have at least five (5) years experience in injection work.
2. Technicians operating injection pumps shall have a minimum of two (2) years experience in injection work.

Record Keeping.

A. Applicator shall maintain detailed records of all work performed. Records shall be maintained on a daily basis and shall include at a minimum the following:

1. Crew supervisor and number of technicians
2. Batch Number and volume of material used per shift.
3. Linear footage of repair per shift.
4. Serial Number of the injection equipment used.

B. Records shall be submitted to the City Engineer for review and approval on a weekly basis.

**DETAILED SPECIFICATION
FOR
PIER CRACK REPAIR**

2 of 5

Submittals.

- A. Submit manufacturer's equipment data and material product sheets including MSDS for:
 - 1. Injection pumps,
 - 2. Grout materials (injection cements, extenders and surface seals),
 - 3. Metering equipment.
 - 4. Phosphoric Acid Cleaner
- B. Submit mixing, handling, and physical properties data sheets including MSDS for each material used on the project.
- C. Submit foreman's and pump technicians' experience documentation as noted in References above.
- D. Submit the proposed injection procedure to be used on site including acid flush and safety procedures for neutralization of waste materials.

Product Handling.

- A. Use products delivered to the site in unopened containers. All materials on site shall be clearly identified with the manufacturer's original labels.
- B. Comply with the manufacturer's requirements for storage, shelf life, and handling of all products.
- C. Only products submitted to, and approved by, the Engineer are to be stored on site. Remove all non-approved, expired, or damaged materials from the project at no cost to the Owner.

Existing Conditions.

- A. Conduct all operations to minimize interference with the Owner's operations. Maintain protected areas and access at all times. Provide safety procedures and utilize safety methods to safeguard the Owner's workers, contractors, and the public from injury.
- B. Erect and maintain temporary partitions and protection barriers to prevent the spreading of dust, adhesive, and debris. Protect existing items and all surfaces which are not indicated to be altered. Protect occupants, contents and other unidentified items during this phase of the project.

Products.

Cementitious Injection Materials

- A. Cementitious injection grout shall consist of a single or two component microfine cementitious materials mixed with potable water to form an injectable, high penetration grouting adhesive.
- B. Performance criteria of the mixed cementitious adhesive/grout for injection:
 - 1. Chemical Base: Portland /Slag cement binders
 - 2. Blaine Fineness Modulus: > 800m²/kg.
 - 3. Grain Size D90: <20 microns
 - 4. Water/Cement Ratio: 0.8 – 2.0.

**DETAILED SPECIFICATION
FOR
PIER CRACK REPAIR**

3 of 5

5. Final Set: < 24 hours

C. Acceptable Cementitious Adhesive/Grouts:

1. Injection Grout, Conproco Corp.
2. Sika Microcement 800, Microfine Cementitious Injection Grout
3. Sika InjectoCem 190, Micro Cement Injection
4. Jahn M30 - #31 Micro Injection Adhesive

Seal Materials

- A. Acceptable surface seal materials shall have adequate strength to hold injection fittings firmly in place and to resist injection pressure adequately to prevent leakage during crack injection.
- B. Properties of the mixed epoxy resin adhesive used for sealing cracks and porting devices.
1. Pot Life: 25-45 minutes
 2. Tack-free to touch time: 2 hours
 3. Consistency (1/2" thick): Non-Sag
- C. Properties of the cured epoxy resin adhesive used for sealing crack surfaces and porting devices:
1. Conform to ASTM C-881, Type I, Grade 3, Class B and C.

Injection Equipment

- A. Type: The equipment used to meter and mix the injection adhesive components and inject the mixed adhesive into the ports shall be portable, positive displacement type pumps. Pumps shall be electric or air powered and shall provide in-line pressure metering.
- B. Discharge Pressure: The injection equipment shall have automatic pressure control capable of discharging the mixed grout at any preset pressure up to 250+/-5 psi and shall be equipped with a manual pressure control override.

Injection Packers

Injection packers or ports shall be a minimum 1/2" diameter with a sealable head which maintains grout within the packer and prevents backflow of the materials from the crack.

Crack and Injection Port Flushing Materials

Provide a phosphoric acid cleaner solution for flushing of drilled ports and cracks prior to injection. Cleaners shall be diluted to manufacturer's recommended levels prior to use.

Execution.

Site Protection

- A. Contractor shall provide all necessary temporary partitions and barriers needed to prevent spreading of dust, debris and collect cleaning and crack flushing solution to prevent these materials from being deposited into or spread production areas of the facility onto the surrounding surfaces and the waterways.
- B. Contractor shall monitor the pier dimensions (on both sides) being repaired, to ensure jacking of the pier surfaces is prevented. Any movement of the pier surfaces during the injection procedure shall be a "Hold Point" with all injection work halted and reported to the Engineer prior to continuation of work in the area.

**DETAILED SPECIFICATION
FOR
PIER CRACK REPAIR**

4 of 5

Surface Cleaning Procedures

- A. Surfaces adjacent to cracks, expansion joints, or other areas of injection shall be cleaned of dirt, dust, grease, oil, efflorescence, paint or other foreign matter detrimental to bond of the injection grout and surface seal system.
- B. Cracks of 1/16" or greater in width shall be routed to a 1/2" minimum depth prior to cleaning.
- C. Grout Injection ports shall be provided along the length of the crack being grouted as follows.
 - 1. Ports shall be provided along both sides of the crack at intervals not exceeding 12 linear inches with every other port positioned on the opposite side of the crack.
 - 2. Ports shall be drilled 12 inches out from the crack on a 45 degree angle so as to intersect the crack at a minimum depth of 12 inches.
 - 3. Drilling of ports shall be with hollow-stem 1/2" diameter drill bits under vacuum for removal debris. Alternate drilling methods which produce a clear and unobstructed port for the injection materials may be used if prior approval is obtained. Procedures for drilling of ports shall be submitted to the Engineer for review and approval as part of the submittals described in Submittals upon award of the contract and prior to start of work.

Injection Procedures

- A. Injection entry ports and the crack being repaired shall be cleaned by injection of a phosphoric acid cleaner solution to flush efflorescence and debris from the ports, crack surfaces and repair areas. Dilution of the cleaner shall be in accordance with the cleaner's manufacturer's recommendations.
- B. After cleaning, the ports and cracks shall be flushed twice with clean water in accordance with phosphoric acid manufacturer's directions. The flushing shall be continued to produce rinse water coming from the repair areas which has a neutral pH.
- C. Once the cleaned and flushed crack area and ports have dried, the surface seal material shall be applied to the routed face of the crack or to the exterior face where cracks are under 1/16 inch width and at the entry ports as needed. Use of epoxy mortars as seals is acceptable.
- D. Sufficient time shall be provided for the surface seal material to gain adequate strength before beginning the injection process.
- E. Injection of the cementitious adhesive grout shall proceed as follows:
 - 1. The crack or area being repaired shall be first injected with potable water for one minute to saturate the concrete surfaces to prevent premature drying of the grout.
 - 2. Begin at the lowest port of the crack, injection of the grout shall begin and continue until there is an appearance of grout material at the next entry port directly above the port being pumped
 - 3. When injection grout is observed by the appearance at the next adjacent port, injection shall be discontinued on the lower port being pumped and this port plugged or seal and injection transferred to the port where material appeared.
 - 4. This injection continues continuously until all ports along the crack being injected have been filled.

**DETAILED SPECIFICATION
FOR
PIER CRACK REPAIR**

5 of 5

- F. Once all ports on a crack have been initially injected, repeat the steps in Paragraph, E within 30 minutes of the initial injection procedure. If there is no flow of grout between adjacent ports which is typical, pressurize the port during the second pass until refusal of the grout for a maximum of one minute at each port.
- G. If port-to-port travel of materials is not indicated during the initial injection sequence, or injection pressure exceeds 150 psi, the injection work on the crack or delamination shall be halted and the Engineer notified. Alternate porting will be determined by the Engineer.

Curing and Finishing

- A. When all injection ports are completely filled, the grout shall be allowed to cure for 24 hours prior to removal of the injection ports and crack seals to prevent draining or runback of the material.
- B. Injection runs, drips, or spills and crack seals shall be removed from the surfaces.
- C. Surfaces adjacent to entry ports shall show no indentations or protrusions greater than +1/8 inch from the original surface.

Measurement and Payment.

The completed work, as described, will be measured and paid for at the contract unit price using the following pay item:

Pay Item	Pay Unit
Pier Crack Repair.....	Foot

Pier Crack Repair includes all labor, equipment and materials necessary for microfine cementitious injection grouting of cracks in the bridge pier.

**DETAILED SPECIFICATION
FOR
EMBEDDED GALVANIC ANODE, SPECIAL**

Description.

This work consists of furnishing all labor, materials and equipment necessary to properly install embedded galvanic anodes in the substructure patching areas in accordance with Section 712 of the 2012 Michigan Department of Transportation (MDOT) Standard Specifications for Construction, except as modified herein or otherwise directed by the Engineer.

Materials.

Furnish materials from suppliers on the MDOT Qualified Products List in accordance with the 2012 Standard Specifications for Construction, except as modified herein.

1. Install Galvashield® XP4 alkali activated embedded galvanic anodes with an electrolytic high grade zinc of 160 grams per anode or an approved equal.

Construction.

Install anodes in accordance with 2012 MDOT Standard Specifications for Construction, per manufacturer's recommendation, and as approved by the Engineer.

Measurement and Payment.

The completed work as described will be measured and paid for using the following contract item (pay item):

Pay Item	Pay Unit
Embedded Galvanic Anode, Special.....	Each

Embedded Galvanic Anode, Special includes all labor, equipment, and materials necessary to perform the work as shown on the plans, as detailed in this detailed specification, and as directed by the Engineer.

**DETAILED SPECIFICATION
FOR
TEMPORARY SUPPORT**

1 of 2

Description.

This work consists of placing temporary supports in accordance with Sections 712 and 713 of the 2012 Michigan Department of Transportation (MDOT) Standard Specifications for Construction, as directed by the Engineer and as described herein.

Temporary supports as detailed on the plans are only required if concrete deterioration is deeper than 6 inches under the beam bearings. During the hand chipping operations near the bearings, the Engineer must be present to observe chipping limits and monitor chipping depth. To ensure the beam bearing area is not compromised, hand chipping operation near the beam bearing areas will be limited to 1 foot wide sections. If the chipping depth reaches 6 inches at these areas, the Contractor must cease chipping in this area. The Engineer will be allowed one day to inspect the subject area and determine if temporary supports are required.

The Contractor shall install temporary supports as directed by the Engineer and as detailed on the plans. The Contractor may submit an alternative temporary support concept for approval by the Engineer in accordance with Section 713.03B. In addition, the Contractor shall submit drawings detailing fabrication and installation of the alternative temporary support system, including, but not limited to, sections, details, and other information that may be required by the Engineer.

The Contractor shall submit to the Engineer detailed plans of the proposed fabricated temporary support in accordance with Section 104.02 of the 2012 MDOT Standard Specifications for Construction.

For each submittal or re-submittal, the Contractor shall allow at least 7 calendar days from the date of the submittal to receive the Engineer's acceptance or request for revisions. The Engineer's comments shall be incorporated into the submitted plans, calculations and descriptions. The Engineer's acceptance is required before beginning the work. Re-submittals shall be reviewed and returned to the General Contractor within 7 calendar days. Required revisions will not be a basis of payment for additional compensation, extra work, or an extension of contract time. The Contractor shall include time for this entire review process in his/her CPM network schedule.

Temporary supports may not be required depending upon the conditions encountered.

Materials.

Provide structural steel for temporary supports meeting the requirements specified in Section 713 of the 2012 MDOT Standard Specifications for Construction and the sizes as shown on the plans. Granular material shall meet the requirements as contained in the Detailed Specification entitled "Granular Material". Geotextile fabric shall be in accordance with Section 910 of the 2012 MDOT Standard Specifications for Construction.

Construction.

Conduct all work in accordance with Sections 712 and 713 of the 2012 MDOT Standard Specifications for Construction except as modified on the plans and herein.

**DETAILED SPECIFICATION
FOR
TEMPORARY SUPPORT**

2 of 2

Measurement and Payment.

The completed work, as described, will be measured and paid for at the contract unit price using the following pay item:

Pay Item	Pay Unit
Support, Column, Temp	Each

Support, Column, Temp includes furnishing, placing and removing supports as required and as indicated on the plans and described herein. Support, Column, Temp indicates the number of beam ends to be supported. Granular material, timber mats and geotextile fabric required for leveling at the temporary support will not be paid for separately but included in the payment for Support, Column, Temp.

**DETAILED SPECIFICATION
FOR
FENCE, CHAIN LINK, 60 INCH WITH 3 STRAND OF BARBED WIRE**

1 of 2

Description.

This work consists of all labor, equipment and materials required to install chain link fence with barbed wires in accordance with Section 808 of the 2012 Michigan Department of Transportation (MDOT) Standard Specifications for Construction and the City of Ann Arbor's Public Services Department Standard Specifications, except as modified herein.

Fence shall be placed in the southeast quadrant of the bridge, east of the concrete chamber and tie into the existing fence located approximately 150 feet east, as shown on the plans.

Materials.

The Contractor shall provide fencing materials in accordance with Section 907 of the 2012 MDOT Standard Specifications for Construction and the City of Ann Arbor's Public Services Department Standard Specifications specified herein.

The elevation of the three (3) rows of barbed wire shall be placed above the top rail of the fence according to the manufacturer's specifications and as approved by the Engineer.

Construction.

Fencing shall be placed in accordance with Section 808 of the 2012 MDOT Standard Specifications for Construction.

Measurement and Payment.

The completed work, as described, will be measured and paid for at the contract unit price using the following pay item:

Pay Item	Pay Unit
Fence, Chain Link, 60 inch with 3 Strand of Barbed Wire.....	Foot

Fence, Chain Link, 60 inch with 3 Strand of Barbed Wire includes all labor, equipment and materials necessary to construct a fence along the southeast quadrant of the bridge, as shown on the plans, connecting to the existing chain link fence. Excavation and concrete required to place the fence posts will not be paid for separately, but included in the pay item Fence, Chain Link, 60 inch with 3 Strand of Barbed Wire.

DETAILED SPECIFICATION FOR FENCE, CHAIN LINK, 60 INCH WITH 3 STRAND OF BARBED WIRE

2 of 2

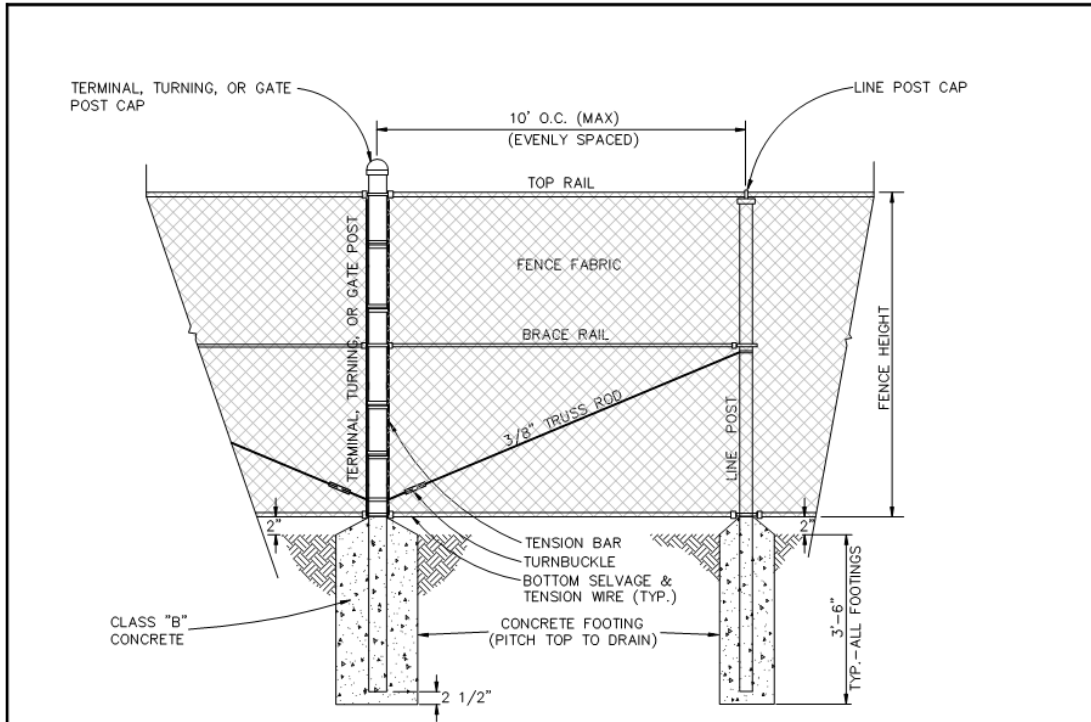

FENCE HEIGHT/SIZE REFERENCE CHART

	4' FENCE	6' FENCE *	8' FENCE	12' FENCE
NOMINAL PIPE SIZES (WEIGHT)				
TERMINAL, TURNING, OR GATE POST	1 1/2" (2.72#/L.F.)	2 1/2" (5.79#/L.F.)	3 1/2" (9.11#/L.F.)	3 1/2" (9.11#/L.F.)
LINE POST	1 1/4" (2.27#/L.F.)	2" (3.65#/L.F.)	2" (3.65#/L.F.)	2" (3.65#/L.F.)
TOP RAIL	1" (1.68#/L.F.)	1 1/4" (2.27#/L.F.)	1 1/4" (2.27#/L.F.)	1 1/4" (2.27#/L.F.)
MIDDLE RAIL	NONE	NONE	1 1/4" (2.27#/L.F.)	1 1/4" (2.27#/L.F.)
BOTTOM RAIL	NONE	NONE	1 1/4" (2.27#/L.F.)	1 1/4" (2.27#/L.F.)
BRACE RAIL	1" (1.68#/L.F.)	1 1/4" (2.27#/L.F.)	1 1/4" (2.27#/L.F.)	1 1/4" (2.27#/L.F.)
FOOTING DIAMETERS				
TERMINAL, TURNING, OR GATE POST	12"	18"	18"	18"
LINE POST	9"	12"	12"	12"

* USE THESE VALUES FOR FENCE MATERIALS INCLUDED IN THE BID ITEM "FENCE, CHAIN LINK, 60 INCH WITH 3 STRAND OF BARBED WIRE".

REVISIONS				REV. NO.	DR. BY	CH. BY	DATE
PUBLIC SERVICES DEPARTMENT CITY OF ANN ARBOR							
CHAIN LINK FENCE							
DR. BY	NCF	CH. BY	CSS	DRAWING NO.			
SCALE	NONE	DATE	1-31-94	SD-L-1			
INCH				SHEET NO.			OF

**DETAILED SPECIFICATION
FOR
GROUT FILLED BAGS**

1 of 3

Description.

This work consists of furnishing all supervision, labor, equipment, and materials, along with performing all operations to install grout filled bags and utilize cement mortar as shown on the plans or as directed by the Engineer. Complete all work in accordance with the 2012 Michigan Department of Transportation (MDOT) Standard Specifications for Construction and the requirements of this detailed specification.

The work includes a method by which fabric bags are used to conform to surrounding irregularities and contain the flow of cement mortar by filling the flexible grout container with a cement mortar pumped into it under controlled pressure. The mortar-filled flexible grout bag(s) must be of a size sufficient to fill the designated void, cavity or area, but no more than 48 inches by 36 inches by 12 inches thick and no less than 16 inches by 10 inches by 8 inches thick, as approved by the Engineer.

Contractor's Personnel.

The installation of flexible grout bags must be performed by experienced workers familiar with the equipment, methods and materials specified. These experienced workers shall have a minimum of two (2) years experience in this type of operation.

The work must be supervised by a full-time superintendent or technical specialist with a minimum of two (2) years experience in this type of operation. Prior to starting the work, the Contractor must provide evidence of relevant work experience to the satisfaction of the Engineer.

Materials.

1. Cement Mortar. Provide a grade R-3 mortar in accordance with section 702 of the 2012 MDOT Standard Specifications for Construction, except provide an entrained air content of 10 percent \pm 1.5 percent.

A. Water reducer. Optional, and must be proportioned into the mixture as recommended by the manufacturer. If added, provide a Type D or Type G water reducing admixture meeting the requirements of subsection 903.02 of the 2012 MDOT Standard Specifications for Construction.

2. Fabric bags.

A. Provide fabric bags that are woven from 100 percent nylon or polypropylene fibers. The manufacturer must provide test data certification, which certifies that the fabric meets the following physical property requirements:

**DETAILED SPECIFICATION
FOR
GROUT FILLED BAGS**

2 of 3

Table 1: Physical Property Requirements of Fabric Bags

Property	Requirement	Test Method
Grab Tensile, lb	319	ASTM D 4632
Mullen Burst Strength, psi	700	ASTM D 3786
Trapezoid Tear Strength, lb	139	ASTM D 4533
Puncture Strength, lb	79	ASTM D 4833
Permittivity, sec ⁻¹	1.0	ASTM D 4491

B. The above properties are specified as minimum values (mean quality control test result minus two standard deviations). Values that represent directional properties are specified for the weaker principle direction. Seam strength must be at least 90 percent of the grab tensile requirement.

C. The fabric bags must be prefabricated to confine the pumped mortar in place without appreciable loss through the seams. Each bag must be provided with a self-closing inlet valve to accommodate insertion of a concrete pumping hose and also an additional relief pipe for grout backfill.

3. Geotextile Liner. Provide geotextile liner in accordance with subsection 910.03.B of the Standard Specifications for Construction.

Equipment.

1. Use a mechanically driven mixer and a positive displacement grout pump for cement mortar mixing and pumping equipment.

2. Use a double tub mixer and agitator capable of mixing cement mortar having water/cement ratios varying from 0.6 to 4.0 measured by volume. The mixer must also have a suitable water measuring device consisting of a water meter or a calibrated water batching tank.

3. Use a positive displacement piston type cement mortar pump capable of delivering material at a pressure of at least 300 psi at the pump discharge.

4. Remove all oil or other rust inhibitors from the mixing drums, stirring mechanisms, and other parts of the equipment in contact with the cement mortar before the mixers are used.

5. The hoses connecting the mortar pump to the cement mortar injection pipe must be at least 1 inch or of such diameter as to convey the grout with a minimum amount of friction.

6. In addition to the above equipment, provide all valves, pressure gauges, pressure hose packers, inserts, tools and accessories required to provide a continuous supply of cement mortar and accurate pressure control.

**DETAILED SPECIFICATION
FOR
GROUT FILLED BAGS**

3 of 3

Construction.

1. Prepare void area upstream of the pier and along the footing of the east abutment by removing all loose and excess material that may damage geotextile liner and grout bags. Place geotextile liner at all locations where grout bags will contact the existing ground. The void area upstream of the pier shall be prepared by removing all loose material and timber debris that may cause damage to the geotextile liner and grout bags within the limits of the cofferdam. The void area along the footing at the east abutment shall be prepared by removing all loose material that may cause damage to the geotextile liner and grout bags using a diver(s).

2. Fill grout bags and all adjacent voids with mortar as recommended by the manufacturer and as directed by the Engineer at the void area upstream of the pier. At the east abutment, use a combination of different grout filled bags to best fill the void. All grout shall be contained within the grout filled bags at this location.

3. Place grout filled bags within the cofferdam at the void upstream of the pier. Place grout filled bags along the footing of the east abutment utilizing a diver(s).

Measurement and Payment.

The completed work, as described, will be measured and paid for at the contract unit price using the following pay item:

Pay Item	Pay Unit
Grout Filled Bags	Cubic Yard

Grout Filled Bags includes all labor (including divers), equipment and materials necessary to fill and install the grout filled bags and geotextile liner. Grout Filled Bags will be measured in cubic yards as determined from the nominal dimension of the bags. The bags shall be measured prior to placement. No allowance will be made for excess, wasted, or otherwise unused cement mortar.

The timber debris located upstream of the pier shall be removed and paid for as "Structures, Rem Portions, Special". The cofferdam enclosing the upstream pier void will be paid for as "Cofferdams".

**DETAILED SPECIFICATION
FOR
SLOPE RESTORATION**

1 of 2

Description.

This work consists of repairing the disturbed Contractor staging area, river access area, and fence removal limits in the southeast quadrant of the bridge and installing turf restoration and/or stabilization materials, including topsoil, fertilizer, seed, mulch, mulch anchoring, and mulch blankets to those areas. Perform this work as shown on the plans, according to 2012 Michigan Department of Transportation (MDOT) Standard Specifications for Construction and Standard Plan R-100 Series, except as modified herein or otherwise directed by the Engineer.

Materials.

Furnish materials and follow application rates as specified in sections 816 and 917, except as modified herein.

1. Furnish the permanent seed mixture(s) specified on the plans, selected from the Approved Manufacturer's list.
2. Furnish Fertilizer, Chemical Nutrient, Class A.
3. Furnish processed or salvaged Topsoil Surface, free of roots, brush, debris, clumps or stones greater than 1 inch diameter.
4. Furnish *Temporary Mulch Blanket* (single side netting) with excelsior or straw mulch and accelerated photodegradable netting from the Qualified Products List.

Construction.

Construct according to subsection 816 and as specified herein. Begin this work as soon as possible after final grading of the areas designated for slope restoration but no later than the maximum time frames stated in subsection 208. Where directed, place slope restoration materials by hand to prevent spill-over beyond specified work limits.

Prior to placing topsoil, shape, compact and assure all areas to be restored are weed free. Place topsoil at 4 inch minimum depth to the disturbed southeast quadrant, including the staging area, fence replacement area and river access area.

Prior to placing seed, furnish and place friable, weed free topsoil. Remove all stones greater than one (1) inch diameter from the finished topsoil surface. Existing rocks embedded in the bank in the river access area, if not removed under Detailed Specification entitled "Clearing, Special", do not need to be removed. Apply seed mixture and fertilizer to the prepared topsoil surface according to subsection 816.03.C.

Place and anchor manufactured rolled mulch blanket according to the manufacturer's published installation guidelines, subsection 816.03.H, and as shown on Standard Plan R-100 Series. Use wood stakes only. Metal pins and staples are prohibited.

Install components of Slope Restoration according to the types described herein, where indicated on the plans or as directed by the Engineer:

**DETAILED SPECIFICATION
FOR
SLOPE RESTORATION**

2 of 2

Slope Restoration consists of topsoil surface, chemical fertilizer, seeding mixture, and *Temporary Mulch Blanket* (single side, accelerated photodegradable netting). In general, place Slope Restoration as directed on 1 on 3 and flatter slope in the disturbed southeast quadrant (contractor staging area).

If an area washes out after slope restoration work has been properly completed and approved by the Engineer, make the required corrections to prevent future washouts and replace the topsoil, fertilizer, seed and mulch. This replacement will be paid for as additional work using the applicable contract items.

If an area washes out for reasons attributable to the Contractor's activity or failure to take proper precautions, replacement will be at the Contractor's expense.

The Engineer will inspect the seeded turf to ensure the end product is well-established, weed free, in a vigorous growing condition, and contains the species called for in the seeding mixture. Scattered bare spots in seeded areas will not be allowed over three (3) percent of the restored area nor greater than 6" x 6" in size.

If the seeded turf is not well established at the end of the first growing season (as defined above), the Contractor will be responsible to re-seed until the turf is well established and approved by the Engineer.

If weeds cover more than ten percent of the total area of slope restoration, as determined by the Engineer, provide weed control according to subsection 816.03.J. Weed control will be at the Contractor's expense, with no additional charges to the project for materials, labor or equipment.

Measurement and Payment.

The completed work for Slope Restoration will be measured in place by the square yard. Payment shall not exceed plan quantity. Payment exceeding plan quantity will be the Contractor's sole expense. No credit or additional compensation will be made for splices, overlaps, embedment, or wasted material for mulch blankets and geotextiles.

Payment for Slope Restoration will be made at seventy five (75) percent of the contract bid price upon completion of installation per this specification. The remaining twenty five (25) percent payment will be made after vegetation is established, as determined by the Engineer.

The completed work as described will be paid for at the contract unit price for the following contract item (pay item):

Pay Item	Pay Unit
Slope Restoration.....	Square Yard

Payment for Slope Restoration includes all materials, labor and equipment required to prepare grades, furnish and place topsoil, chemical fertilizer, seed, mulch blankets, and stakes as specified herein.

APPENDIX



MICHIGAN DEPARTMENT OF ENVIRONMENTAL QUALITY
WATER RESOURCES DIVISION
PERMIT

ISSUED TO:

City of Ann Arbor
Wastewater Treatment Plant
49 Old Dixboro Road
Ann Arbor, MI 48105

Permit No.	15-81-0007-P
Issued	April 16, 2015
Extended	
Revised	
Expires	April 16, 2020

This permit is being issued by the Michigan Department of Environmental Quality (MDEQ) under the provisions of the Natural Resources and Environmental Protection Act, 1994 PA 451, as amended (NREPA), and specifically:

- Part 301, Inland Lakes and Streams
- Part 315, Dam Safety
- Part 325, Great Lakes Submerged Lands
- Part 323, Shorelands Protection and Management
- Part 303, Wetlands Protection
- Part 353, Sand Dunes Protection and Management
- Part 31, Floodplain/Water Resources Protection

Permission is hereby granted, based on permittee assurance of adherence to State of Michigan requirements and permit conditions, to:

Permitted Activity:

Place approximately a total of 5.4 cubic yards of grout filled bags on bottomland of the Huron River within two locations to fill existing scour holes upstream of the pier and along the east abutment face for bridge support. Install a temporary portadam system 50 feet long by 25 feet wide on both sides of existing pier location while bridge maintenance repair takes place.

All work shall be completed in accordance with the attached plans and the terms and conditions of this permit.

Water Course Affected: Huron River

Property Location: Washtenaw County, Ann Arbor Township, Section 36
Subdivision, Lot Town/Range 2S, 6E Property Tax No.

Authority granted by this permit is subject to the following limitations:

- A. Initiation of any work on the permitted project confirms the permittee's acceptance and agreement to comply with all terms and conditions of this permit.
- B. The permittee, in exercising the authority granted by this permit, shall not cause unlawful pollution as defined by Part 31, Water Resources Protection, of the NREPA.
- C. This permit shall be kept at the site of the work and available for inspection at all times during the duration of the project or until its date of expiration.
- D. All work shall be completed in accordance with the approved plans and specifications submitted with the application and/or plans and specifications attached to this permit.
- E. No attempt shall be made by the permittee to forbid the full and free use by the public of public waters at or adjacent to the structure or work approved.
- F. It is made a requirement of this permit that the permittee give notice to public utilities in accordance with Act 53 of the Public Act of 1974 and comply with each of the requirements of that Act.
- G. This permit does not convey property rights in either real estate or material, nor does it authorize any injury to private property or invasion of public or private rights, nor does it waive the necessity of seeking federal assent, all local permits, or complying with other state statutes.
- H. This permit does not prejudice or limit the right of a riparian owner or other person to institute proceedings in any circuit court of this state when necessary to protect his rights.

- I. Permittee shall notify the MDEQ within one week after the completion of the activity authorized by this permit, by completing and forwarding the attached preaddressed postcard to the office addressed thereon.
- J. This permit shall not be assigned or transferred without the written approval of the MDEQ.
- K. Failure to comply with conditions of this permit may subject the permittee to revocation of permit and criminal and/or civil action as cited by the specific state act, federal act, and/or rule under which this permit is granted.
- L. All dredged or excavated materials shall be disposed of in an upland site (outside of floodplains, unless exempt under Part 31, and wetland).
- M. In issuing this permit, the MDEQ has relied on the information and data that the permittee has provided in connection with the submitted application for permit. If, subsequent to the issuance of a permit, such information and data prove to be false, incomplete, or inaccurate, the MDEQ may modify, revoke, or suspend the permit, in whole or in part, in accordance with the new information.
- N. The permittee shall indemnify and hold harmless the State of Michigan and its departments, agencies, officials, employees, agents, and representatives for any and all claims or causes of action arising from acts or omissions of the permittee, or employees, agents, or representative of the permittee, undertaken in connection with this permit. The permittee's obligation to indemnify the State of Michigan applies only if the State (1) provides the permittee or its designated representative written notice of the claim or cause of action within 30 days after it is received by the State and (2) consents to the permittee's participation in the proceeding on the claim or cause of action. It does not apply to contested case proceedings under the Administrative Procedures Act challenging the permit. This permit shall not be construed as an indemnity by the State of Michigan for the benefit of the permittee or any other person.
- O. Noncompliance with these terms and conditions and/or the initiation of other regulated activities not specifically authorized shall be cause for the modification, suspension, or revocation of this permit, in whole or in part. Further, the MDEQ may initiate criminal and/or civil proceedings as may be deemed necessary to correct project deficiencies, protect natural resource values, and secure compliance with statutes.
- P. If any change or deviation from the permitted activity becomes necessary, the permittee shall request, in writing, a revision of the permitted activity from the MDEQ. Such revision request shall include complete documentation supporting the modification and revised plans detailing the proposed modification. Proposed modifications must be approved, in writing, by the MDEQ prior to being implemented.
- Q. This permit may be transferred to another person upon written approval of the MDEQ. The permittee must submit a written request to the MDEQ to transfer the permit to the new owner. The new owner must also submit a written request to the MDEQ to accept transfer. The new owner must agree, in writing, to accept all conditions of the permit. A single letter signed by both parties which includes all the above information may be provided to the MDEQ. The MDEQ will review the request and if approved, will provide written notification to the new owner.
- R. Prior to initiating permitted construction, the permittee is required to provide a copy of the permit to the contractor(s) for review. The property owner, contractor(s), and any agent involved in exercising the permit are held responsible to ensure that the project is constructed in accordance with all drawings and specifications. The contractor is required to provide a copy of the permit to all subcontractors doing work authorized by the permit.
- S. Construction must be undertaken and completed during the dry period of the wetland. If the area does not dry out, construction shall be done on equipment mats to prevent compaction of the soil.
- T. Authority granted by this permit does not waive permit requirements under Part 91, Soil Erosion and Sedimentation Control, of the NREPA, or the need to acquire applicable permits from the County Enforcing Agent.
- U. Authority granted by this permit does not waive permit requirements under the authority of Part 305, Natural Rivers, of the NREPA. A Natural Rivers Zoning Permit may be required for construction, land alteration, streambank stabilization, or vegetation removal along or near a natural river.
- V. The permittee is cautioned that grade changes resulting in increased runoff onto adjacent property is subject to civil damage litigation.
- W. Unless specifically stated in this permit, construction pads, haul roads, temporary structures, or other structural appurtenances to be placed in a wetland or on bottomland of the waterbody are not authorized and shall not be constructed unless authorized by a separate permit or permit revision granted in accordance with the applicable law.
- X. For projects with potential impacts to fish spawning or migration, no work shall occur within fish spawning or migration timelines (i.e., windows) unless otherwise approved in writing by the MDNR, Fisheries Division.
- Y. Work to be done under authority of this permit is further subject to the following special instructions and specifications:
 - 1. Authority granted by this permit does not waive permit or program requirements under Part 91, Soil Erosion and Sedimentation Control, of the NREPA, or the need to acquire applicable permits from the County Enforcing Agent (CEA). To locate the Soil Erosion Program Administrator for your county visit www.mi.gov/deqstormwater and look for Soil Erosion and Sedimentation Control Program under "Related Links".

2. The authority to conduct the activity as authorized by this permit is granted solely under the provisions of the governing act as identified above. This permit does not convey, provide, or otherwise imply approval of any other governing act, ordinance, or regulation, nor does it waive the permittee's obligation to acquire any local, county, state or federal approval or authorization, necessary to conduct the activity.
3. Prior to the removal of the existing structures, cofferdams of steel sheet piling, gravel bags, clean stone, coarse aggregate, concrete, or other acceptable barriers shall be installed to isolate all construction activity from the water. The barriers shall be maintained in good working order throughout the duration of the project. Upon project completion, the accumulated materials shall be removed and disposed of at an upland site.
4. All cofferdam and temporary steel sheet pile shall then be removed in its entirety, unless specifically shown to be left in place on the approved plans. Cofferdam and sheet pile that is left in place shall be cut off at the elevation shown on the plans and shall be a minimum of one foot below the stream bottom.
5. Prior to the initiation of any permitted construction activities, a sedimentation barrier shall be constructed immediately down gradient of the construction site. Sedimentation barriers shall be specifically designed to handle the sediment type, load, water depth, and flow conditions of each construction site throughout the anticipated time of construction and unstable site conditions. The sedimentation barrier shall be maintained in good working order throughout the duration of the project. Upon project completion, the accumulated materials shall be removed and disposed of at an upland (non-wetland, non-floodplain) site and stabilized with seed and mulch. The sedimentation barrier shall then be removed in its entirety and the area restored to its original configuration and cover.
6. No fill, excess soil, or other material shall be placed in any wetland or surface water area not specifically authorized by this permit, its plans, and specifications.
7. This permit does not authorize or sanction work that has been completed in violation of applicable federal, state, or local statutes.
8. The permit placard shall be kept posted at the work site, in a prominent location at all times for the duration of the project, or until permit expiration.
9. This permit is being issued for the maximum time allowed and no extensions of this permit will be granted. Initiation of the construction work authorized by this permit indicates the permittee's acceptance of this condition. The permit, when signed by the MDEQ, will be for a five-year period beginning at the date of issuance. If the project is not completed by the expiration date, a new permit must be sought.

By: _____

A handwritten signature in black ink, appearing to read "Luke Golden", is written over a horizontal line. To the right of the line, the word "for" is written in a cursive script.

Luke Golden
Water Resources Division
517-780-7910

cc: Ann Arbor Township Clerk (via e-mail)
Ms. Talia Belill, DLZ Michigan, Inc. (via e-mail)

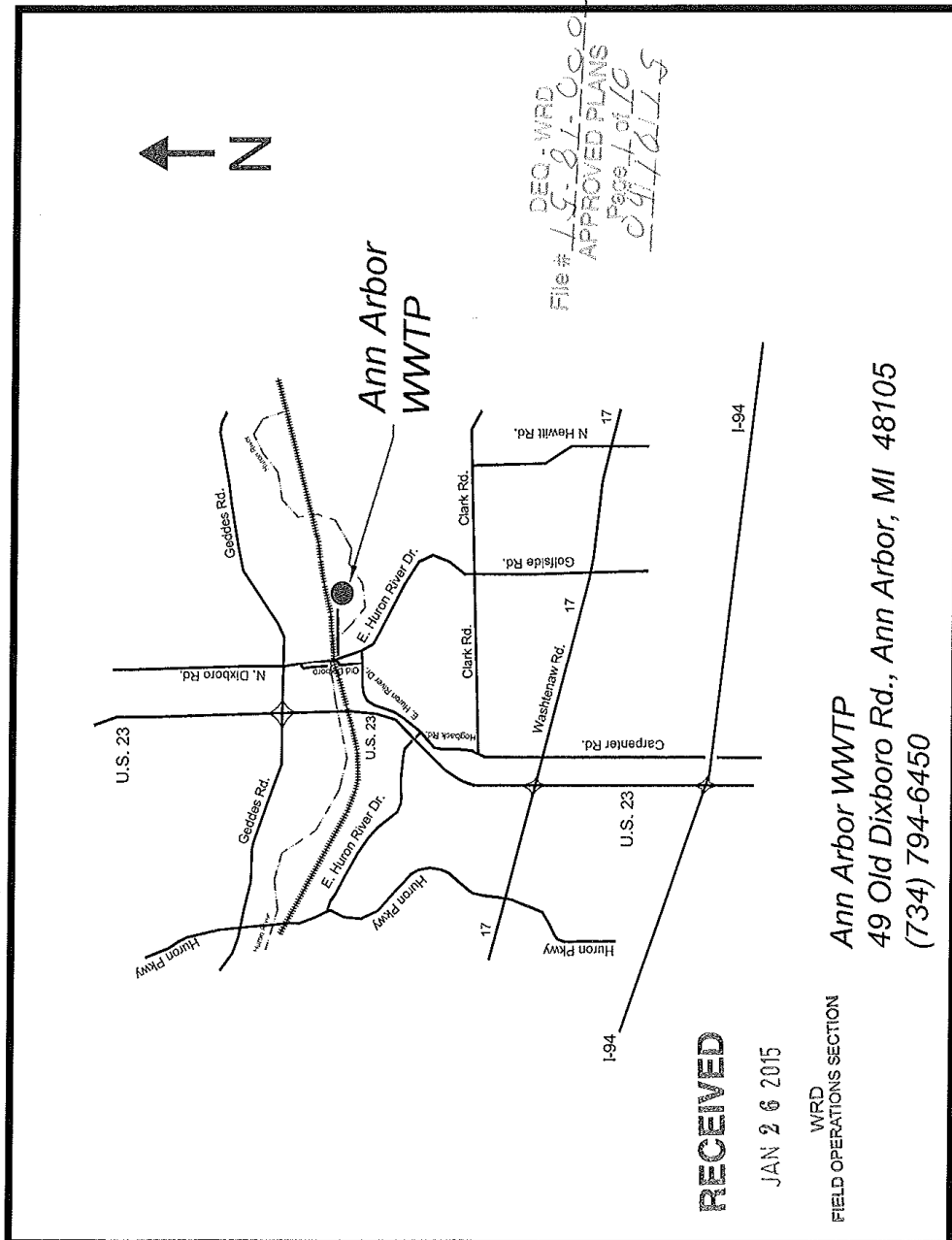

DEC. WRD
 File # 15-81-0007
 APPROVED PLANS
 Page 1 of 10
 09/16/15

RECEIVED

JAN 26 2015

WRD
 FIELD OPERATIONS SECTION

Ann Arbor WWTP
 49 Old Dixboro Rd., Ann Arbor, MI 48105
 (734) 794-6450

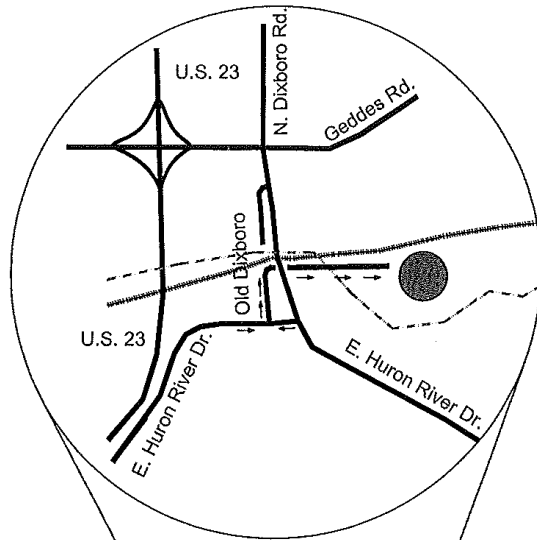

DEO-WPD
 File # 15-21-0007
 APPROVED PLANS
 Page 2 of 10
 OVI/LS

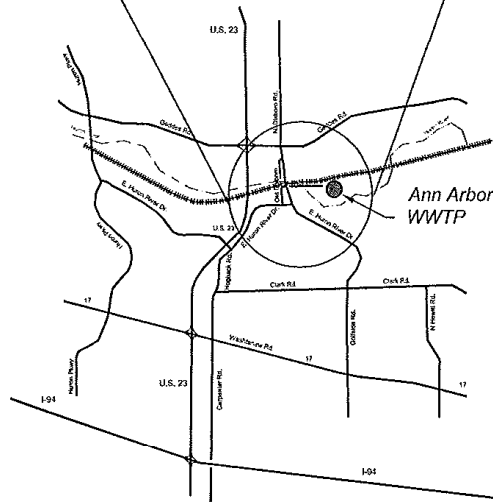

RECEIVED

JAN 26 2015

WRD
 FIELD OPERATIONS SECTION

Ann Arbor WWTP
 49 Old Dixboro Rd., Ann Arbor, MI 48105
 (734) 794-6450

RECEIVED

JAN 26 2015

WRD

LOCATION MAP
TREATMENT PLANT DRIVE OVER HURON RIVER



Google Earth

APPROVED PLANS
Page 7 of 9
04/11/15

PROJECT SITE PLAN
TREATMENT PLANT DRIVE OVER HURON RIVER

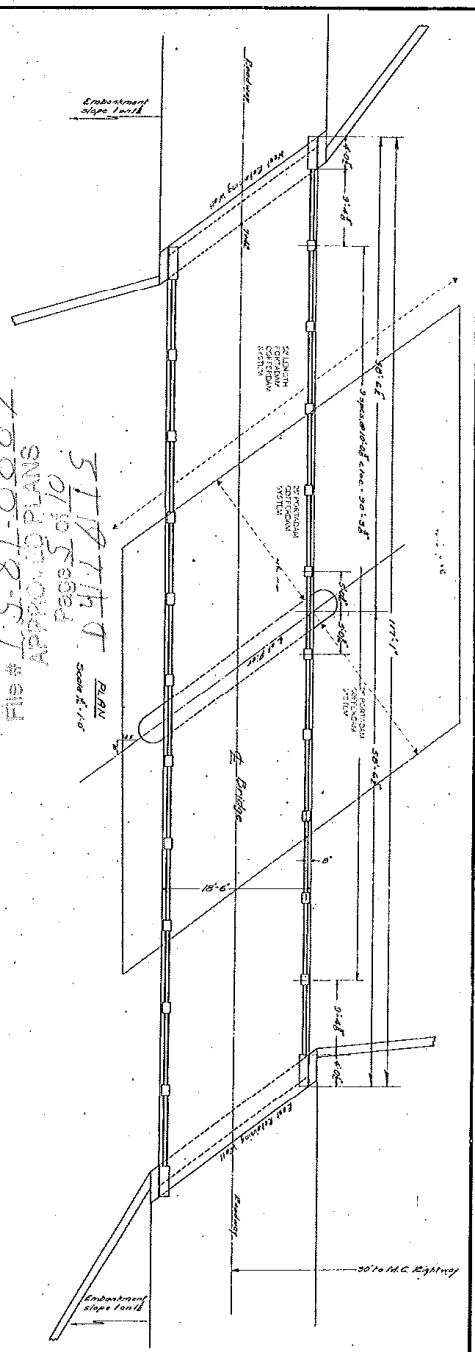

DEC-WRD
 1-5-87-0002
 APPROVED PLANS
 519714
 5710 SCS
 BALD
 SCALE 1/4" = 1'-0"

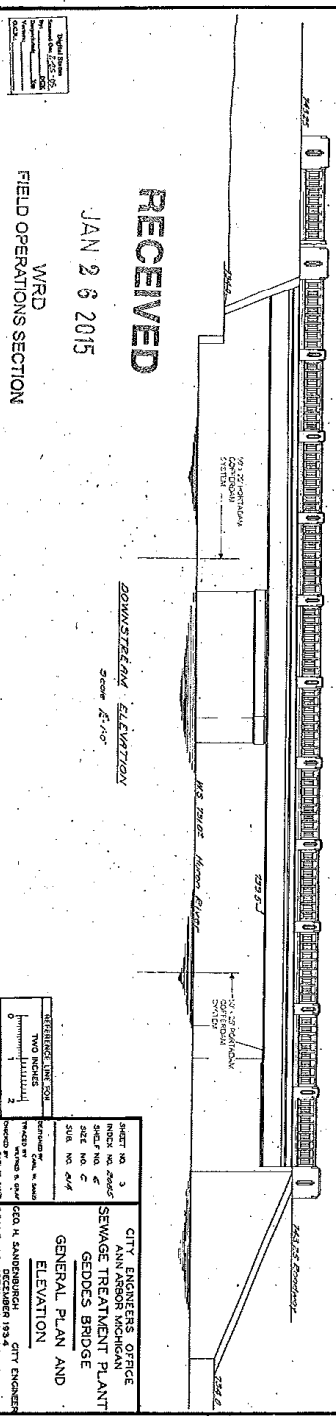

RECEIVED
 JAN 2 6 2015
 WRD
 FIELD OPERATIONS SECTION

SHEET NO. 3 PROJECT NO. 1-5-87-0002 SCALE: AS NOTED	CITY ENGINEERS OFFICE ANN ARBOR TREATMENT PLANT GEODES BRIDGE GENERAL PLAN AND ELEVATION
DRAWN BY: [Name] CHECKED BY: [Name]	CITY ENGINEERS 100 N. SANDBOROUGH ANN ARBOR, MI 48106 SCALE: AS NOTED

49413-00

PROJECT SITE PLAN
TREATMENT PLANT DRIVE OVER HURON RIVER

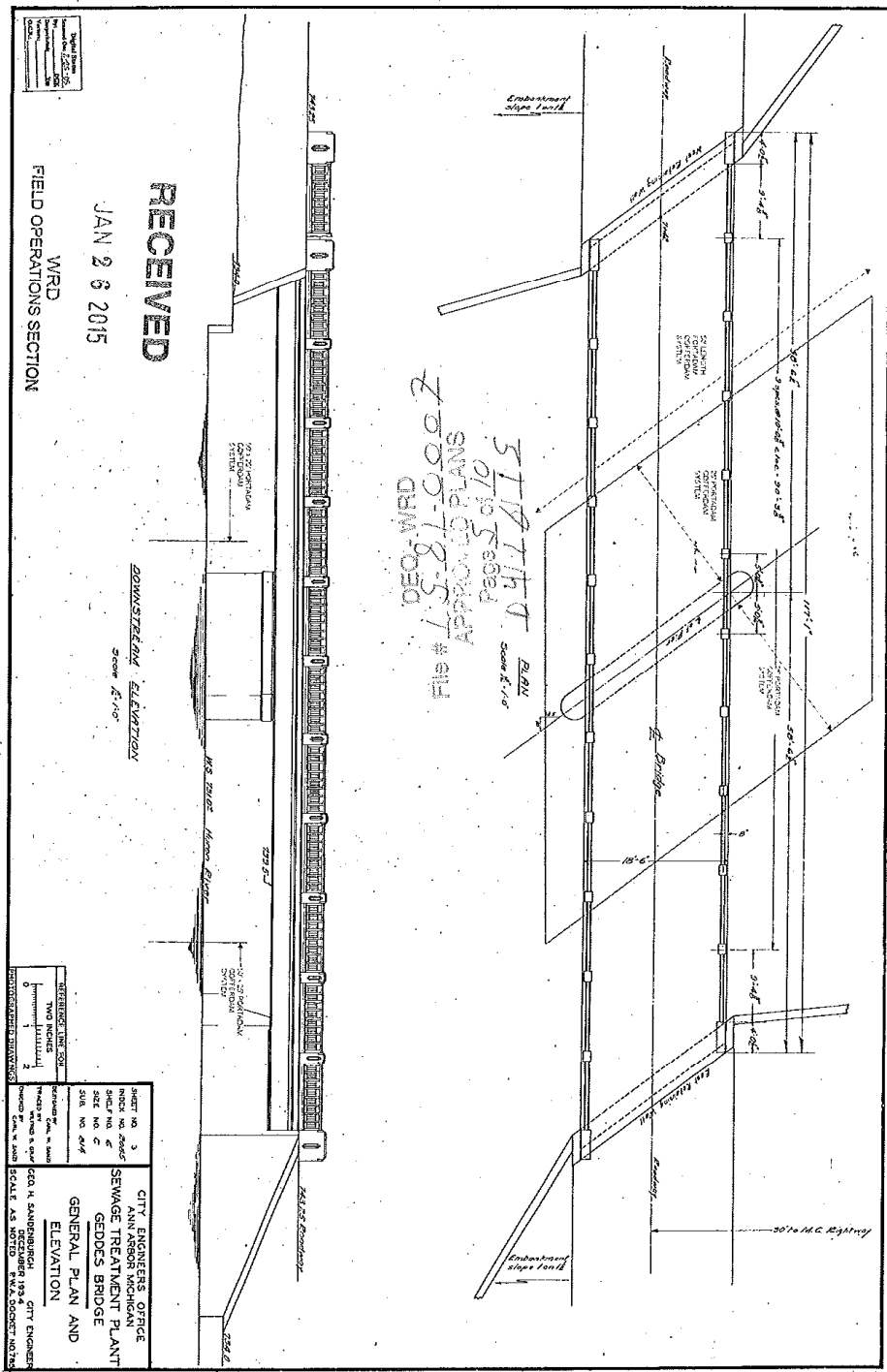

CROSS SECTION
TREATMENT PLANT DRIVE OVER HURON RIVER

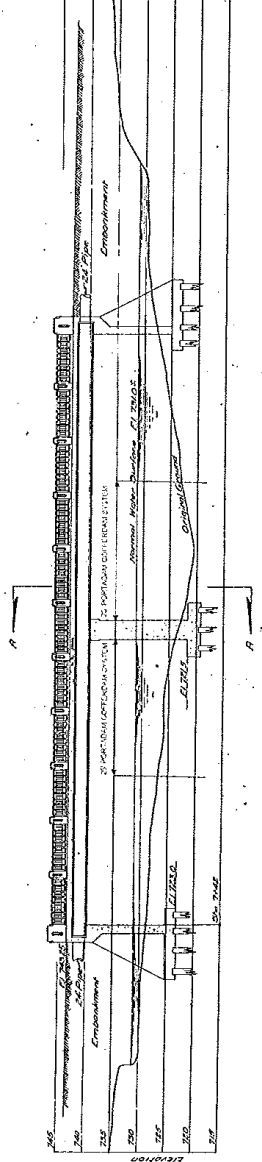

SECTIONAL ELEVATION ON B
Scale 1/4" = 1'-0"

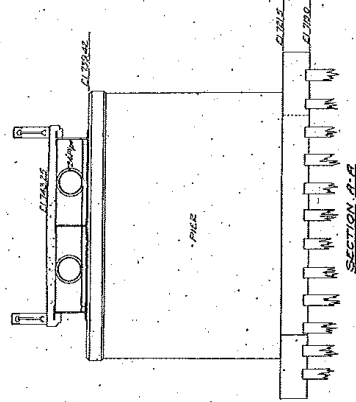

FILE # 15-27-0009
APPROVED PLANS
Page 2 of 10
0411215

RECEIVED

JAN 26 2015

WRD
FIELD OPERATIONS SECTION

CITY ENGINEER'S OFFICE ANN ARBOR, MICHIGAN	
SEWAGE TREATMENT PLANT GEDDES BRIDGE	
BRIDGE SECTIONS	
SHEET NO. 13	DESIGNED BY: [Signature]
INDEX NO. 20007	CHECKED BY: [Signature]
DRAWING NO. 274	DATE: 04/11/15
SCALE: AS NOTED	CITY ENGINEER D. N. SANCHEZ

494D-13

511717-0
 07/02/2008
 SWIFT PLANS
 APPROVED PLANS
 File # 9111
 DEO WRD

RIVER DEPTH SOUNDINGS IN PLAN VIEW
 TREATMENT PLANT DRIVE OVER HURON RIVER

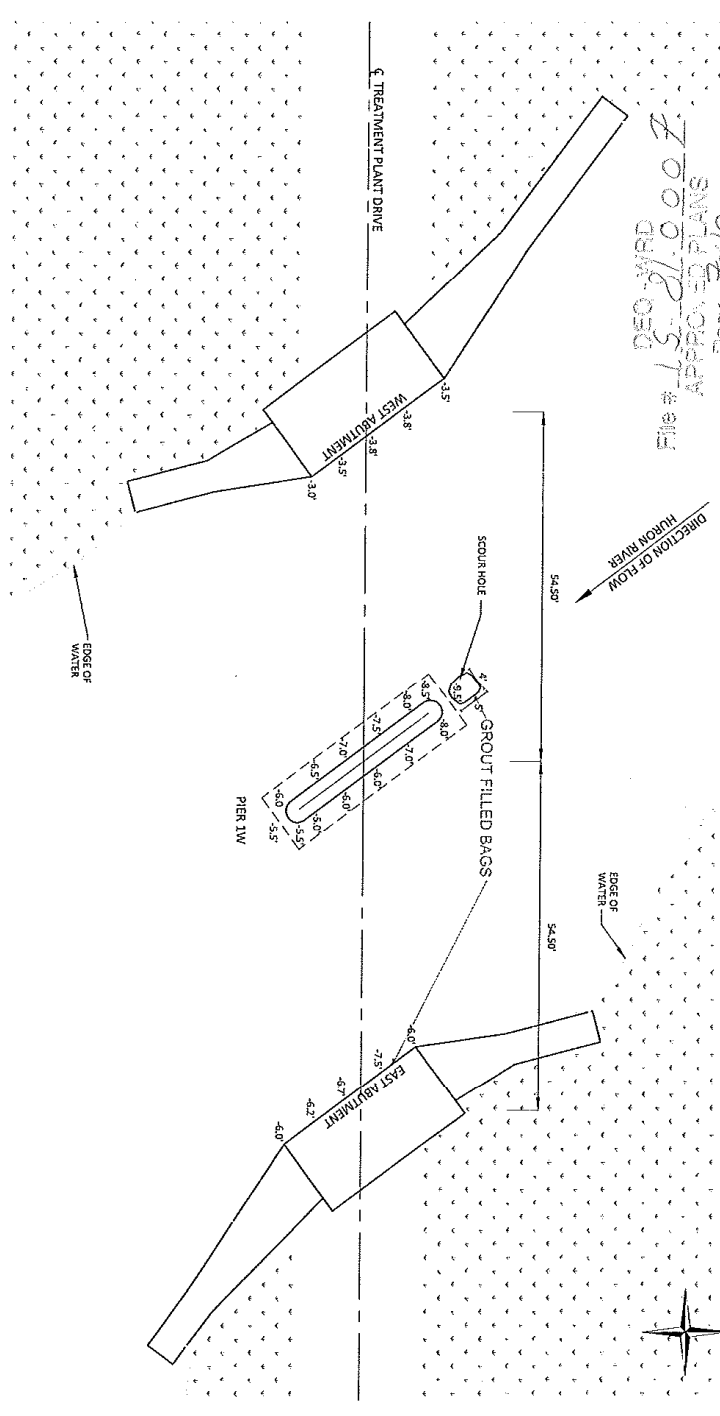

NOTE:
 SURFACE ELEVATION AT THE TIME OF PIER ON 6/27/24 WAS 73.4'
 BENCHMARK = 725.42' (TOP OF PIER 1W NORTH END)

RECEIVED
 JAN 2 9 2015

WRD
 FIELD OPERATIONS SECTION

LEGEND: STEEL SHEET PILING RIPRAP SOUNDING DEPTH FROM WATER SURFACE TO RIVER BOTTOM.		CITY OF ANN ARBOR TREATMENT PLANT DRIVE TO W.W.T.P. OVER HURON RIVER SN: 11078 UNDERWATER BRIDGE INSPECTION	
DRAWING NO. UNDERWATER BRIDGE INSPECTION DATE: 07/27/08 DRAWN BY: AT	FIELD NO. 1044-075 CHECKED BY: AT	DRAWING NO. UNDERWATER BRIDGE INSPECTION DATE: 07/27/08 DRAWN BY: AT	FIELD NO. 1044-075 CHECKED BY: AT

ABUTMENT ELEVATIONS
TREATMENT PLANT DRIVE OVER HURON RIVER

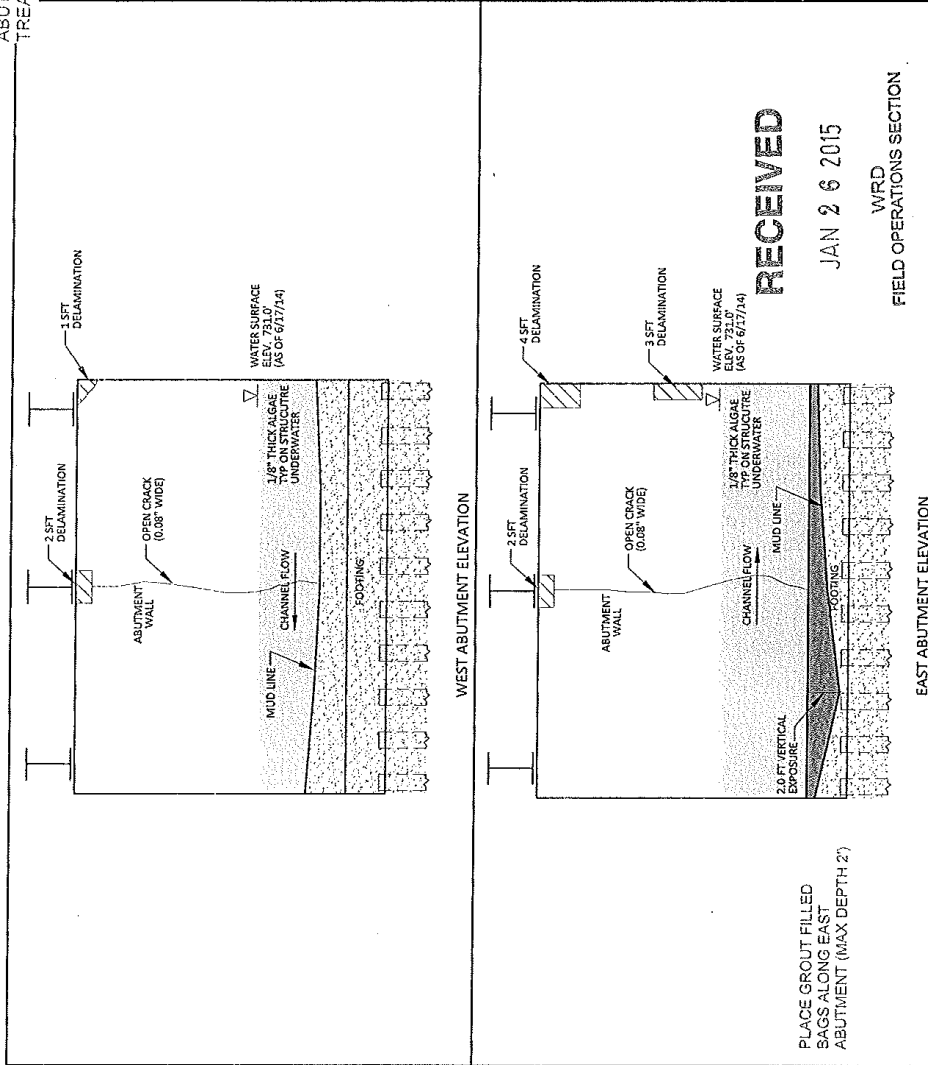

CITY OF ANN ARBOR	
TREATMENT PLANT DRIVE TO W.W.T.P. OVER HURON RIVER	
JAN. 1.10.08	
UNDERWATER BRIDGE INSPECTION	
Drawing No. UNDERWATER INSPECTION	Scale 1" = 10'-0"
Date: 07/20/14	File No: 154-276
Drawn By: R	Checked By: AL

DEQ-WRD
File # 15-21-0007
APPROVED PLANS
PAGE 2 OF 10
D.L.L.S.

PIER ELEVATIONS
TREATMENT PLANT DRIVE OVER HURON RIVER

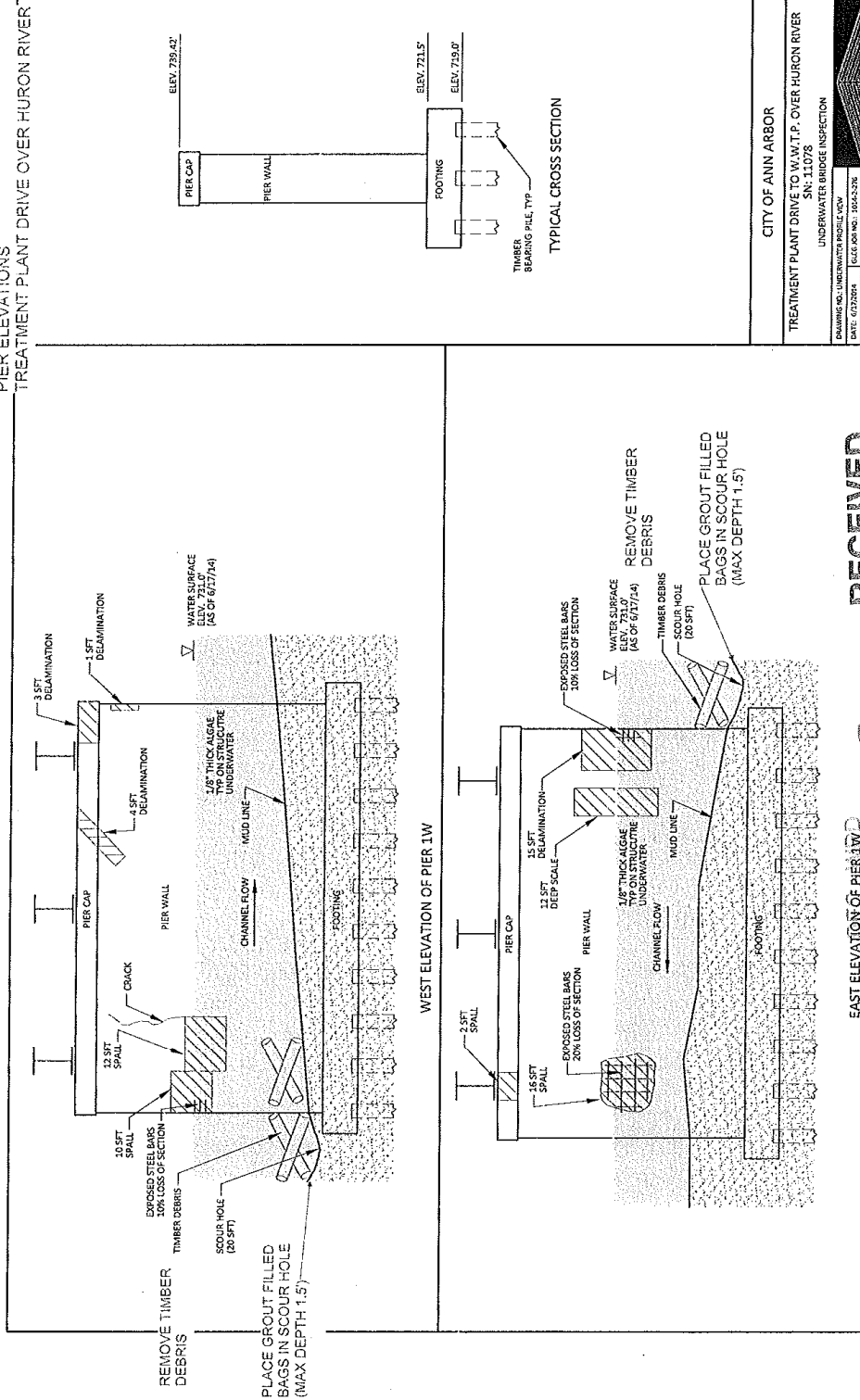

CITY OF ANN ARBOR
TREATMENT PLANT DRIVE TO W.W.T.P. OVER HURON RIVER
SN: 11075
UNDERWATER BRIDGE INSPECTION
DRAWING NO: UNDERWATER BRIDGE VIEW
DATE: 07/20/14
SCALE: 1/8"=1'-0"
DRAWN BY: J.R.
CHECKED BY: A.T.
CREATED BY: J.R.
CITY OF ANN ARBOR ENGINEERING GROUP, LLC

RECEIVED
JAN 26 2015
WRD
FIELD OPERATIONS SECTION

Fig # 15-04-002
APPENDIX PLANS
Page 9 of 10
04/11/15

PORTADAM COFFERDAM SYSTEM
TREATMENT PLANT DRIVE OVER HURON RIVER

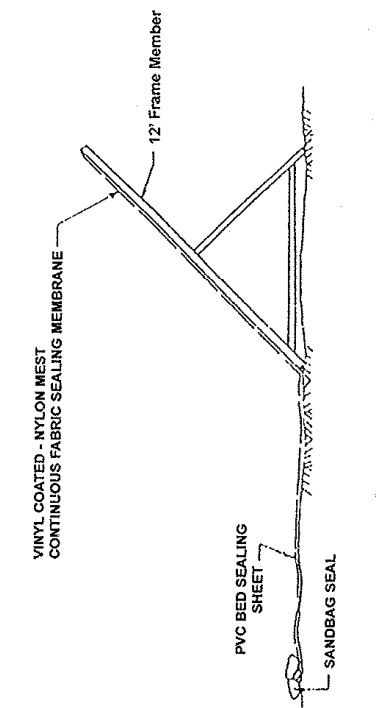

SEALING MEMBRANE DETAIL
CROSS-SECTION
N.T.S.

- NOTES:**
- OPTIONAL ATTACHMENTS
 - BACK BRACE POLE
 - HORIZONTAL ADDITIONAL BRACING
 - SINGLE FRAME ATTACHMENTS FOR IRREGULAR CONTOURS & TURNS
 - ANCHOR BOLTS MAY BE REQUIRED ON HARD ROCK, FLAT OR CONCRETE SURFACES.

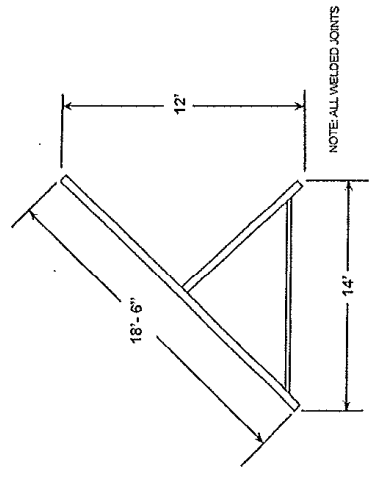

12' HIGH FRAME DETAIL

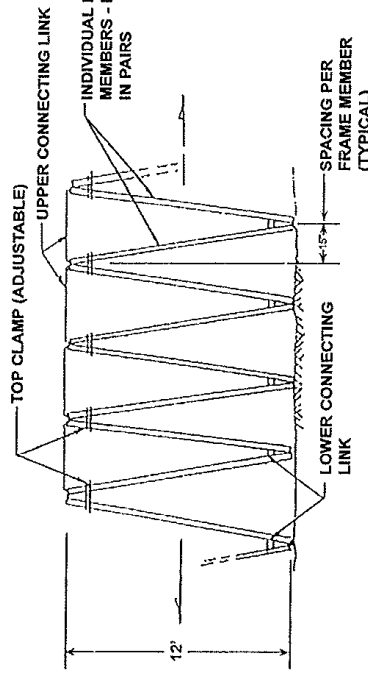

FRAME ASSEMBLY PROFILE

RECEIVED

JAN 26 2015

WRD
FIELD OPERATIONS SECTION

DEQ-WRD
File # 15-21-0007
APPROVED PLANS
Page 10 of 10
D. J. B. 1/15

12' HIGH FRAMEWORK & FABRIC
SEALING MEMBRANE DETAILS
STANDARD PORTADAM SYSTEM ASSEMBLY

Portadam, Inc. Williamstown, NJ

CITY OF ANN ARBOR LIVING WAGE ORDINANCE

RATE EFFECTIVE APRIL 30, 2015 - ENDING APRIL 29, 2016

\$12.81 per hour

If the employer provides health care benefits*

\$14.30 per hour

If the employer does **NOT** provide health care benefits*

Employers providing services to or for the City of Ann Arbor or recipients of grants or financial assistance from the City of Ann Arbor for a value of more than \$10,000 in a twelve-month period of time must pay those employees performing work on a City of Ann Arbor contract or grant, the above living wage.

ENFORCEMENT

The City of Ann Arbor may recover back wages either administratively or through court action for the employees that have been underpaid in violation of the law. Persons denied payment of the living wage have the right to bring a civil action for damages in addition to any action taken by the City.

Violation of this Ordinance is punishable by fines of not more than \$500/violation plus costs, with each day being considered a separate violation. Additionally, the City of Ann Arbor has the right to modify, terminate, cancel or suspend a contract in the event of a violation of the Ordinance.

* Health Care benefits include those paid for by the employer or making an employer contribution toward the purchase of health care. The employee contribution must not exceed \$.50 an hour for an average work week; and the employer cost or contribution must equal no less than \$1/hr for the average work week.

The Law Requires Employers to Display This Poster Where Employees Can Readily See It.

**For Additional Information or to File a Complaint Contact:
Mark Berryman at 734/794-6500 or mberryman@a2gov.org**



Vendor Conflict of Interest Disclosure Form

All vendors interested in conducting business with the City of Ann Arbor must complete and return the Vendor Conflict of Interest Disclosure Form in order to be eligible to be awarded a contract. Please note that all vendors are subject to comply with the City of Ann Arbor's conflict interest policies as stated within the certification section below.

If a vendor has a relationship with a City of Ann Arbor official or employee, an immediate family member of a City of Ann Arbor official or employee, the vendor shall disclose the information required below.

Certification: I hereby certify that to my knowledge, there is no conflict of interest involving the vendor named below:

- 1. No City official or employee or City employee's immediate family member has an ownership interest in vendor's company or is deriving personal financial gain from this contract.
2. No retired or separated City official or employee who has been retired or separated from the City for less than one (1) year has an ownership interest in vendor's Company.
3. No City employee is contemporaneously employed or prospectively to be employed with the vendor.
4. Vendor hereby declares it has not and will not provide gifts or hospitality of any dollar value or any other gratuities to any City employee or elected official to obtain or maintain a contract.
5. Please note any exceptions below:

Table with 2 columns: Vendor Name, Vendor Phone Number. Includes a section for Conflict of Interest Disclosure with checkboxes for Relationship to employee, Interest in vendor's company, and Other.

*Disclosing a potential conflict of interest does not disqualify vendors. In the event vendors do not disclose potential conflicts of interest and they are detected by the City, vendor will be exempt from doing business with the City.

I certify that the information provided is true and correct by my signature below:

Signature of Vendor Authorized Representative, Date, Printed Name of Vendor Authorized Representative

PROCUREMENT USE ONLY

- Yes, named employee was involved in Bid / Proposal process.
No, named employee was not involved in procurement process or decision.

CITY OF ANN ARBOR NON-DISCRIMINATION ORDINANCE

Relevant provisions of Chapter 112, Nondiscrimination, of the Ann Arbor City Code are included below. You can review the entire ordinance at [www. a2gov.org/departments/city-clerk](http://www.a2gov.org/departments/city-clerk)

Intent: It is the intent of the city that no individual be denied equal protection of the laws; nor shall any individual be denied the enjoyment of his or her civil or political rights or be discriminated against because of actual or perceived age, arrest record, color, disability, educational association, familial status, family responsibilities, gender expression, gender identity, genetic information, height, HIV status, marital status, national origin, political beliefs, race, religion, sex, sexual orientation, source of income, veteran status, victim of domestic violence or stalking, or weight.

Discriminatory Employment Practices: No person shall discriminate in the hire, employment, compensation, work classifications, conditions or terms, promotion or demotion, or termination of employment of any individual. No person shall discriminate in limiting membership, conditions of membership or termination of membership in any labor union or apprenticeship program.

Discriminatory Effects: No person shall adopt, enforce or employ any policy or requirement which has the effect of creating unequal opportunities according to actual or perceived age, arrest record, color, disability, educational association, familial status, family responsibilities, gender expression, gender identity, genetic information, height, HIV status, marital status, national origin, political beliefs, race, religion, sex, sexual orientation, source of income, veteran status, victim of domestic violence or stalking, or weight for an individual to obtain housing, employment or public accommodation, except for a bona fide business necessity. Such a necessity does not arise due to a mere inconvenience or because of suspected objection to such a person by neighbors, customers or other persons.

Nondiscrimination by City Contractors: All contractors proposing to do business with the City of Ann Arbor shall satisfy the contract compliance administrative policy adopted by the City Administrator in accordance with the guidelines of this section. All city contractors shall ensure that applicants are employed and that employees are treated during employment in a manner which provides equal employment opportunity and tends to eliminate inequality based upon any classification protected by this chapter. All contractors shall agree not to discriminate against an employee or applicant for employment with respect to hire, tenure, terms, conditions, or privileges of employment, or a matter directly or indirectly related to employment, because of any applicable protected classification. All contractors shall be required to post a copy of Ann Arbor's Non-Discrimination Ordinance at all work locations where its employees provide services under a contract with the city.

Complaint Procedure: If any individual has a grievance alleging a violation of this chapter, he/she has 180 calendar days from the date of the individual's knowledge of the allegedly discriminatory action or 180 calendar days from the date when the individual should have known of the alleged discriminatory action to file a complaint with the city's Human Rights Commission. If an individual fails to file a complaint alleging a violation of this chapter within the specified time frame, the complaint will not be considered by the Human Rights Commission. The complaint should be made in writing to the Human Rights Commission. The complaint may be filed in person with the City Clerk, by e-mail at aahumanrightscommission@gmail.com, or by mail (Ann Arbor Human Rights Commission, PO Box 8647, Ann Arbor, MI 48107). The complaint must contain information about the alleged discrimination, such as name, address, phone number of the complainant and location, date and description of the alleged violation of this chapter.

Private Actions For Damages or Injunctive Relief: To the extent allowed by law, an individual who is the victim of discriminatory action in violation of this chapter may bring a civil action for appropriate injunctive relief or damages or both against the person(s) who acted in violation of this chapter

THIS IS AN OFFICIAL GOVERNMENT NOTICE AND
MUST BE DISPLAYED WHERE EMPLOYEES CAN READILY SEE IT.