

***SOIL EROSION AND SEDIMENTATION
CONTROL MANUAL
April 2006***



**CONSTRUCTION AND TECHNOLOGY
SUPPORT AREA**

Attention Department Users

This manual is to remain with the assigned user. If the user relocates within the Department, this manual should remain with the user. To assure continued receipt of updates, the user should notify their previous and new office publications coordinator to make the necessary changes to the publications distribution lists. If this manual is left at a vacant position, it should be discarded rather than passed on.

FOREWORD

This manual has been developed to aid Michigan Department of Transportation (MDOT) personnel in the selection and application of adequate and efficient soil erosion and sedimentation control measures during project development and delivery. The information provided by this manual is used in conjunction with the Standard Specifications for Construction; the project plans and proposal; and other Department publications. When considered as a whole, these documents satisfy the requirement for MDOT as an Authorized Public Agency under Part 91 of Public Act 451 of 1994, Natural Resources and Environmental Protection Act, as amended to develop, implement and enforce approved soil erosion and sedimentation control procedures.

This 2006 edition incorporates input from planning, design, construction, and maintenance staff in Lansing, region offices and the TSCs; new and revised legislation; and improved construction materials and processes. This document is formatted to allow revised pages to be easily substituted. It may be necessary to retain superseded pages for reference on projects which have been advertised prior to the date revisions are implemented (ref. Standard Specifications for Construction, subsection 101.01).

The information in this manual is subject to continuous review and evaluation. All revisions to this manual must be approved by the Michigan Department of Environmental Quality (MDEQ) prior to implementation. Comments and questions should be directed to the Operations Environmental Stewardship Engineer (OESE).

AUTHORIZED PUBLIC AGENCY - POLICY STATEMENT

MDOT is aware of our responsibilities to preserve the natural resources of the State of Michigan when providing transportation services. MDOT's Mission Statement, and more specifically, the Vision Statement, recognizes this responsibility.

MDOT Mission Statement: Providing the highest quality integrated transportation services for economic benefit and improved quality of life.

For copies of this manual contact the MDOT Publications Office
Telephone: (517) 322-1676 Fax: (517) 322-1395

E-Mail: MDOT-Publications@Michigan.gov
or visit our Web Site at
www.mdot.state.mi.us/orderpubs

THIS PAGE BLANK

TABLE OF CONTENTS

Foreword

Terminology Used in this Manual

1. Introduction

1.1 Applicable Laws and Administrative Rules.....	1-1
1.2 MDOT's SESC Program.....	1-2
1.3 Key MDOT Organizational and Procedural Definitions	1-4
1.4 Related MDOT Documents	1-5

2. Project Development

2.1 Planning Phase	2-1
2.2 Design Phase	2-2

3. Project Delivery

3.1 Construction Projects	3-1
3.2 Maintenance Projects and Maintenance Activities	3-3

4. Compliance and Enforcement

4.1 Construction Projects	4-1
4.2 Maintenance Projects and Activities.....	4-2
4.3 MDEQ Progressive Compliance (Escalation) Process.....	4-3

5. Permit Requirements, Acts and Rules

5.1 MDOT Permit Coordinators.....	5-1
5.2 Permit Requirements.....	5-1

6. SESC Measures (Erosion & Sedimentation Details)

6-1

Appendix: Reference Information

Environmental Procedure for Ditch Cleanout (Activity #12300)

Sample NPDES Inspection Report (Form 1126)

Sample Earth Change Plan

THIS PAGE BLANK

TERMINOLOGY USED IN THIS MANUAL

In addition to the terms defined in subsection 101.02 of the *MDOT Standard Specifications for Construction* the terms defined here are used in this manual

Construction Project	Project that is administered and completed by Department construction staff or by a consultant on behalf of the Department. Construction projects may include a full set of plans or may be log jobs. Used to differentiate from a maintenance project.
Contract Agency	County or other local unit of government with which MDOT has entered into a contract for provision of specific functions generally related to the maintenance of state owned roadways.
Department	As used in this document, Department refers to the Michigan Department of Transportation.
Earth Change	A man-made change in the natural cover or topography of land including cut and fill which may result in or contribute to soil erosion or sedimentation of the waters of the state. The term includes, but is not limited to, clearing, grading, excavating and filling activities (a.k.a. earth disturbance).
Earth Change Plan	A document that meets all requirements of Part 17 rule R 323.1703. The elements of this plan may be incorporated throughout the construction contract documents or the plan may be a stand-alone document for projects that do not involve preparation of a full set of plans. (i.e. log job or maintenance projects/activities) (aka SESC Plan)
Limits of Earth Disturbance	Unless stated otherwise in the contract documents, the limits of earth disturbance will extend ten feet beyond the slope stake line except in areas adjacent to wetlands where the earth disturbance limits will be at the slope stake line. (ref. General Plan Notes)
Erosion Control Measure	Any of the specific measures described in this manual, section 208 of the Standard Specifications for Construction or other contract documents; designed, constructed, and maintained to reduce or control soil erosion or off-site sedimentation. Erosion control measures may be constructed devices or construction practices intended to minimize soil erosion and off- site sedimentation. (a.k.a. best management practices or BMP)
Floodplain	An area of land adjoining a river or stream that will be inundated by a 1 percent chance (100 year) flood. (ref: MDOT Drainage Manual, Section 2.9.10.3)
Log Job	Straightforward and uncomplicated construction or maintenance project for which a full set of plans is not prepared, relying instead on sketches, written narrative and other information, in the proposal. If an earth change plan is required for a log job, this will also be included in the

	proposal. The project log is a contract document. (ref. MDOT Road Design Manual, Section 1.04)
Maintenance Project	Project that is administered and completed by Department maintenance staff or by a contract agency on behalf of the Department. Maintenance projects are typically limited in scope and impact and are often log jobs. Used to differentiate from a construction project.
Maintenance Activity	Routine work performed by MDOT direct forces or by a contract agency for the purpose of extending the useful life and ensuring the safe condition of the transportation infrastructure.
Part 91 Inspector	An individual with SESC certification whose responsibilities include ensuring that MDOT maintenance projects/activities and construction projects comply with Part 91 of Act 451.
Part 91 Rules	Terminology generally used in this manual when referring to applicable soil erosion and sedimentation control rules.
Part 31 Inspector	Certified storm water operator authorized to conduct inspections as required by Part 31 of Act 451.
Private Party	Permitted entity that is not a governmental agency and not a utility as defined by the Standard Specifications for Construction. Used in the context of permitted work on MDOT right-of-way. (aka third party)
Stabilization	The establishment of vegetation or the proper placement, grading, or covering of soil to ensure its resistance to soil erosion, sliding, or other earth movement.
Wetland	Land characterized by the presence of water at a frequency and duration sufficient to support and under normal circumstances does support wetland vegetation or aquatic life. Wetland area may be commonly referred to as a bog, swamp or marsh. Consult with Region/ Lansing central office staff, if necessary, for wetland designation.

1. INTRODUCTION

The Michigan Department of Environmental Quality has designated the Michigan Department of Transportation as an Authorized Public Agency (APA) under Part 91, Soil Erosion and Sedimentation Control, of Public Act 451 of 1994, Natural Resources and Environmental Protection Act, as amended (hereinafter referred to as Act 451). This status is evaluated on a region-by-region basis through an audit process conducted by MDEQ. SESC program audits generally take place on a five-year cycle. As an APA, preparation and approval of individual project specific soil erosion and sedimentation control permits is not required. In return, MDOT accepts responsibility for enforcement of the Department's program and procedures related to soil erosion and sedimentation control. The mechanism for enforcement is through the implementation of this manual, the Standard Specifications for Construction and all other contract documents.

The information and direction provided in this manual satisfies the Part 91 requirement for MDOT to have a documented program and adequate procedures to comply with applicable soil erosion and sedimentation control regulations. To ensure continued APA status, earth change activities on MDOT right-of-way, regardless of size or location, will be conducted in accordance with Part 91, the rules promulgated thereunder, this manual, and all related MDOT manuals and guides.

It is important that all MDOT personnel support the Department's commitment to minimize soil erosion and off-site sedimentation as part of the overall environmental stewardship responsibility accepted by the Department. This is accomplished, in part, by compliance with and enforcement of all contract documents, performance guides and manuals

1.1 Applicable Laws and Administrative Rules

Act 451 requires various environmental measures to be enacted throughout the life of state transportation projects and activities to ensure that issues related to a healthy environment are appropriately considered. Act 451 includes several parts, two of which (Part 31 and Part 91) govern the soil erosion and sedimentation control procedures described in this manual. The remaining parts of Act 451 involve project specific permits such as those related to floodplains; inland lakes and streams; wetlands; dam safety; shoreline protection; Great Lakes submerged lands; and sand dunes.

1.1.1 Part 31, Water Resources Protection - Part 31 of Act 451 addresses the protection and conservation of the water resources of the state. This includes prohibition of pollution of the waters of the state by storm water runoff carrying sediment from earth change activities.

Part 21 Wastewater Discharge Permit of the state administrative rules contains the administrative rules promulgated for Part 31 of Act 451. These rules were promulgated to implement amendments to Act 451 that authorized the state wastewater discharge permit system compatible with the National Pollutant Discharge Elimination System (NPDES). Whenever this document references NPDES regulations or rules this is construed to mean Part 31 and the rules promulgated thereunder.

NPDES rule R323.2190(2)(e) requires construction sites disturbing one or more acres of land to undergo NPDES inspections with documentation of these inspections kept on file by MDOT for a period of at least three years from the date of the inspection.

1.1.2 Part 91, Soil Erosion and Sedimentation Control - The primary intent of Part 91 of Act 451 is to protect the waters of the state by minimizing erosion and controlling sediment.

Part 17 Soil Erosion and Sedimentation Control of the state administrative rules contains the administrative rules promulgated for Part 91 of Act 451. Whenever this document references SESC regulations or rules this is construed to mean Part 91 and the rules promulgated thereunder. In general, the term “Part 91 rules” is used in this manual to refer to both the regulations and the rules governing soil erosion and sedimentation control.

SESC rule R323.1704(1) requires soil erosion and sedimentation control permits for earth change projects which disturb one or more acres of land, or which is within 500 feet from the water’s edge of a lake or stream. MDOT’s APA status supersedes the individual permit process provided that the Department enforces soil erosion and sedimentation control procedures approved by MDEQ.

1.2 MDOT’s Soil Erosion and Sedimentation Control Program

This manual represents one facet of MDOT’s overall soil erosion and sedimentation control program. The overall program consists of commitment to environmental stewardship responsibilities; appropriate staff training; specifications and project plans that address erosion control issues; and preparation and/or enforcement of earth change plans as required.

1.2.1 Environmental Stewardship Commitment - The commitment to fully support the activities necessary to maintain APA status is embodied in the MDOT mission statement and vision statement. MDOT is committed to complying with the procedures outlined in this manual and other MDEQ permit conditions throughout all phases of project development (planning and design) and delivery (construction and maintenance).

A proactive approach is necessary to effectively minimize erosion from disturbed areas thereby reducing resulting off-site sedimentation. Whenever practicable, stronger contract language; stronger enforcement of this contract language; and better inspection, documentation and follow-up will be implemented to reach this goal.

Project/activity specific inspection and maintenance of erosion and sedimentation controls are the responsibility of MDOT and the Contractor. If deficiencies are documented, MDOT will notify the Contractor of the deficiency and work to bring the site into compliance within five days from the date of the notice, or other time frame stated in the notice, or will submit a plan to MDEQ proposing appropriate measures.

1.2.2 SESC (Part 91) Training - Those responsible for administering Part 91 and those having decision-making authority for earth change plan development or review, inspections, or enforcement will complete MDEQ-sponsored SESC training and must pass the required examination. The MDEQ-sponsored training consists of one day of general instruction on sedimentation and erosion control issues, one day on design and specification of control measures, and a one half-day written exam. In lieu of classroom training, a self-study course is available. A training certificate is valid for five years.

Completing the recertification process is required for renewal. The OESE will work with TSCs and Region offices and the Construction & Technology Technical Training Coordinator to arrange for Part 91 training for MDOT staff.

Decision-makers are, at a minimum, TSC Managers, Project Managers, Development and Delivery Engineers, Assistants to the Development and Delivery Engineers, Maintenance Supervisors/Coordinators, and Aeronautics Project Managers. Decision-makers also include the Part 91 Inspector for each project. A Part 91 Inspector for each construction project and maintenance project/activity involving earth change activities will be designated. This individual will be identified in the preconstruction meeting minutes for construction projects and in the daily work schedule for maintenance projects/activities.

The Part 91 Inspector is responsible for enforcing MDOT standards and specifications to ensure continued site compliance. This will be accomplished by inspecting and documenting site conditions related to Part 91 and taking action to prevent or correct deficient soil erosion and sedimentation control measures.

- 1.2.3 NPDES (Part 31) Training** - Field construction and maintenance personnel responsible for project inspections are required to monitor soil erosion and sedimentation control measures in compliance with the NPDES requirements. These inspectors will complete MDEQ-sponsored Construction Site Storm Water training and obtain certification as a storm water operator. The TSCs are responsible for coordinating Part 31 training for their staff.
- 1.2.4 In-House Training** - Additional training related to environmental stewardship including erosion control and storm water management will be developed and conducted on an as-needed basis.
- 1.2.5 Earth Change Plan** - An earth change plan conforming to rule R323.1703 will be prepared by MDOT for projects and activities involving earth changes that are not covered by the approved procedures in this manual. The elements of this plan may be incorporated throughout the MDOT contract documents or may be a stand-alone document for projects and activities that do not involve preparation of a full set of plans. At this time, the only exception to this requirement is ditch clean-out (Activity 12300) when this activity is conducted according to MDOT-approved work methods.

The Contractor is required to develop an earth change plan for earth change activity undertaken outside the limits of earth disturbance but within the right-of-way. The Engineer will review all earth change plans submitted by the Contractor to determine if all requirements of rule R323.1703 are addressed and that the plan is effective. This review and approval will be completed before the Contractor is allowed to begin any earth change activity in the area between the limits of earth disturbance and the right-of-way.

NOTE: *The Contractor is required to develop an earth change plan unless the only earth change activity undertaken outside the limits of earth disturbance is within the clearing limits as specified by subsection 201 of the standard specifications and as shown on the plans. However, adequate measures must be implemented and maintained to effectively prevent or reduce erosion and subsequent off-site sedimentation that may result from this activity.*

1.3 Key MDOT Organizational and Procedural Definitions

This manual is organized to complement MDOT's Development and Delivery structure. The development organization consists of staff dedicated to planning, obtaining right-of-way, and designing construction projects. The delivery organization consists of staff overseeing or performing construction and maintenance of the highway system.

During a construction project, the construction unit is responsible for contract administration and oversight of private construction firms or vendors (hereinafter referred to as Contractors) performing highway/bridge projects. These projects are constructed in conformance with the MDOT Standard Specifications for Construction, which states: *"It is the responsibility of the Contractor to take such measures as may be necessary and comply with all federal, state and local laws and regulations for the protection of the public health, safety, welfare, and environment in the performance of the work."* The Contractor is further bound by contract language to comply with all such laws and regulations throughout the life of the project, including the installation and maintenance of temporary erosion control measures and the installation of permanent measures. (Ref. Standard Specifications for Construction subsections 107.01, 107.15 and 208.03).

This contractual obligation placed on the Contractor does not diminish MDOT's ultimate responsibility under Act 451 for minimizing soil erosion and reducing the subsequent off-site sedimentation to the maximum extent practicable during construction of our transportation system.

A maintenance project/activity may be completed by MDOT maintenance forces, contract agencies, or Contractors with oversight provided by the maintenance unit. This work includes the installation and maintenance of temporary erosion control measures on maintenance projects. The maintenance unit is also responsible for maintaining permanent erosion control measures along all state highways after a construction project or a maintenance project contract is closed out.

1.3.1 Contract Documents - For MDOT projects, the term 'contract documents' used throughout this manual is construed as, *"The written agreement between the Department and the Contractor setting forth the obligations of the parties for the performance of and payment for the prescribed work. The contract includes the advertisement for bids, bidding document, progress schedule, contract form, contract bonds, standard specifications, supplemental specifications, special details, standard plans, plans, proposal, addenda, notice of award, ... "* and other documents as applicable. (Ref. Standard Specifications for Construction, subsection 101.03)

This manual is included by reference in the standard specifications and is therefore a contract document. (Ref. Standard Specifications for Construction, page iii and Supplemental Specification for Errata to the 2003 Standard Specifications for Construction) The E&S Details in this manual may be modified within special details, plans, the proposal, or other contract documents to meet site-specific field conditions for a given project.

1.3.2 Project Manager - The 'Project Manager' referenced in this document is the person responsible for developing the contract documents. By signing the title page of the plans, the Project Manager and Delivery Engineer are recommending approval of the contract documents to the Director or designee of MDOT. All project managers

responsible for developing construction or maintenance contract documents will complete the MDEQ-sponsored SESC (Part 91) Training.

1.3.3 Engineer - The 'Engineer' referenced in this document is defined in the Standard Specifications for Construction as: "*The Director of the Department or the Engineer designated by the Director, acting directly or through authorized representatives, who is responsible for engineering supervision of the construction...*" (Ref. Standard Specifications for Construction, subsection 101.03) The Engineer assigned responsibility for a specific project is the TSC Delivery Engineer for the geographic area in which the project is located. The Delivery Engineer assigns engineers and technicians as authorized representatives to perform inspection and testing on all projects.

1.3.4 MDOT Construction Permits - Non-MDOT work performed by others on MDOT right-of-way requires a permit from MDOT to occupy the right-of-way. In accordance with definitions contained in the Part 91 rules, an applicant for a utility or other governmental agencies engaged in construction in a public right-of-way is considered to be the landowner for purposes of obtaining and complying with a soil erosion permit, when applicable, from the appropriate enforcing agency (municipal or county). Information related to SESC and storm water management requirements is provided with each application package. (Ref. Construction Permit Manual and Act 368)

Utility companies and private parties performing utility/driveway work under an MDOT permit to occupy the right-of-way must minimize soil erosion and off right-of-way sedimentation. It is the responsibility of the appropriate MEA or CEA to enforce compliance with Act 451 on those projects.

1.4 Related MDOT Documents

This manual includes the procedures for establishing soil erosion and sedimentation controls for earth change activities regulated under Part 31 and Part 91 of Act 451 resulting from the construction, maintenance and operation of the state transportation system. MDOT is committed to the careful consideration and implementation of these procedures during the planning, design and completion of all operations that involve earth change activities.

References are made in this manual to other MDOT publications as well as to specific parts of relevant environmental statutes. Due to the volume of information necessary for MDOT to carry out its mission and the need to stay current with changing laws, rules and engineering technology, no attempt is made to reproduce all related MDOT documents in this manual. Where reference is made in this manual to related MDOT procedures and publications, the portions of those documents that address soil erosion and sedimentation control are considered to be included as if they were repeated here in their totality. Where practical, cross references are specifically listed in this manual. If information, direction, or procedures related to soil erosion and sedimentation control contained in related documents is less restrictive than Part 91, or this manual, then Part 91 and this manual will take precedence.

For projects let under the Standard Specifications for Construction, this manual is considered a contract document. The Contractor is obligated to conform to the information and guidance provided herein and all site specific soil erosion and sedimentation control measures included in the contract documents.

At a minimum, the following MDOT documents contain specifications, standards and/or practices related to soil erosion and sedimentation control and are referenced herein.

1.4.1 MDOT Standard Specifications for Construction - Contains the current written directions, provisions and requirements pertaining to performance of work on MDOT projects. It is the base document controlling a project. The standard specifications may be modified by supplemental specifications and special provisions contained in the contract documents.

- Section 107 Legal Relations and Responsibilities to the Public
- Section 108 Prosecution and Progress
- Section 109 Measurement and Payment
- Section 201 Clearing
- Section 205 Roadway Earthwork
- Section 208 Soil Erosion and Sedimentation Control
- Section 813 Slope Protection
- Section 816 Turf Establishment
- Section 916 Erosion Control Materials
- Section 917 Turf and Landscaping Materials

1.4.2 Standard Plans - Drawings approved for repetitive use, showing details to be used where appropriate for the construction of road and bridge appurtenances.

- R-96 Series - Soil Erosion and Sedimentation Control Measures
- R-100 Series - Sodding, Seeding and Tree Planting

1.4.3 Road Design Manual - Provides criteria for the design of roads and for the preparation of road plans.

- Subsection 2.02.03.F Erosion Control
- Subsection 10.04.04.B Drainage and NPDES Runoff Controls
- Subsection 10.04.04 C Soil Erosion and Sedimentation Control

1.4.4 Drainage Manual - Gives the design engineer a basic working knowledge of hydrology, hydraulics and storm water management.

- Subsection 9.1.2 Soil Erosion and Sedimentation Control

1.4.5 Storm Water Management Plan - The SESC program is directly related to the MDOT storm water management program as one of six minimum measures required for compliance with the statewide permit issued to MDOT under Part 31 of Act 451. Section 3.5 of the Storm Water Management Plan contains a discussion of the SESC program in the context of storm water control to minimize sediment load to the waters of the state during the construction and operation of MDOT facilities.

1.4.6 Program/Project Management System's Preconstruction Process Documentation Manual - Documents the Department's preconstruction process as it pertains to construction project development. The preconstruction process begins with the preliminary planning for projects, and ends with the construction contract award.

- Task 3710 Develop Required Mitigation
- Task 3720 Submit Environmental Permit Applications
- Task 3730 Obtain Environmental Permits

- 1.4.7 Construction Manual** - Guide detailing the authority and responsibility for project administration. Provides instructions on project management, construction surveying, construction inspection and materials sampling.
- Section 103 Work Orders
 - Section 201 Clearing
 - Section 205 Roadway Earthwork
 - Section 208 Soil Erosion and Sedimentation Control
- 1.4.8 Construction Permit Manual** - Guidance on procedures for administering the permit process for public utility or private party work on, or use of, the trunkline right-of-way within the provisions of federal and state laws.
- 1.4.9 Maintenance Performance Guides** - These guides describe the equipment, materials and recommended work methods for various maintenance activities.
- 1.4.10 MDEQ Soil Erosion and Sedimentation Control Training Manual** - While not an MDOT publication, this training manual contains much useful information on the proper selection, design and construction of SESC measures. The training manual is available from the MDEQ web site.

THIS PAGE BLANK

2. PROJECT DEVELOPMENT

Project Development involves the planning, design and acquisition of real estate, if required, for the project.

2.1 Planning Phase

Effective erosion control begins in the planning phase of a project. Areas with unstable or transportable soils, such as loess soils, alluvial fans, and some glacial deposits are potential problem areas for erosion during construction. Identification of these soil types is a necessary prerequisite to selecting erosion control measures for a project. If applicable, soil borings and reports will be reviewed and field investigations conducted during the planning phase of a project to identify these areas. Information on the potential for a given soil to erode can be found in county soil surveys and by contacting the local Conservation District office or the Construction and Technology Geotechnical Services Unit.

During the planning phase of a project, areas susceptible to damage from excessive sedimentation will also be identified. Some examples are rivers, impoundments, irrigation systems, lakes, streams, and wetlands. Cropland, home sites, and other developed areas will also be considered.

Each construction project is subject to one of three types of early preliminary engineering analysis during the planning phase depending on the nature of the project and the anticipated social, economic, and environmental impacts and necessary mitigation. These reviews establish the environmental clearances required from federal, state, and/or local resource agencies. Recommended erosion control measures will be incorporated into the contract documents during the design phase for implementation in the construction phase.

2.1.1 Categorical Exclusion - The basic review level is a Categorical Exclusion. This review considers actions that individually or cumulatively do not involve significant environmental impacts. They are actions that:

- Do not induce significant impacts to planned growth or land use;
- Do not require the relocation of significant numbers of people;
- Do not have a significant impact on any cultural, natural, recreational, historic, or other resources;
- Do not involve significant air, noise, or water quality impacts; and,
- Do not have a significant impact on travel patterns.

2.1.2 Environmental Assessment - The next level of review is an Environmental Assessment. This review is considered a decision document. The assessment is performed when there is uncertainty as to the significance of the impacts of a particular project. The assessment considers the project need, alternatives considered, impacts, and comments and coordination with the Federal Highway Administration (FHWA) and the public. If a Finding of No Significant Impact is received from FHWA, the project proceeds. If significant impacts are found, the project moves to the Environmental Impact Statement process.

2.1.3 Environmental Impact Statement - The highest, most comprehensive, level of review is an Environmental Impact Statement (EIS). This review considers multiple studies and analyses with extensive involvement of environmental resource agencies throughout the

review. The final EIS reports on the environmental impacts and mitigation necessary for the particular project. A Record of Decision is required from the FHWA for a project to proceed. The EIS process is a comprehensive environmental analysis of the purpose of and need for the project; the potential transportation solutions by considering corridors with various alignments, and a detailed environmental analysis of a recommended alternative.

For major new alignment projects undergoing the EIS environmental process the alignment and grade, especially at stream crossings, will be carefully considered in an attempt to minimize SESC and NPDES concerns. The alignment of a highway may be shifted to eliminate or minimize encroachment into a surface water environment. A change in grade may be made to avoid exposing highly erodible soils.

Proposed alignment and grade changes need to be consistent with highway safety criteria and should be made to blend and fit the highway to the natural landscape. This will minimize the extent of cut and fill during construction and reduce future erosion related maintenance problems. In designing the project's line and grade, it is important that ground water and surface water be allowed to pass through the highway right-of-way or be intercepted with minimal disturbance to streams and without causing erosion problems.

Whenever practical, stream crossings will be made at stable reaches of a stream where straight banks are evident and there are no meanders. The direction and amount of water flowing at various stages must be considered in locating hydraulic openings to avoid excessive scour and erosion problems. To reduce the potential for these problems, stream crossings and encroachments should be kept to a minimum.

2.2 Design Phase

Projects are designed to minimize earth disturbances with emphasis placed on areas with highly erodible soils and areas adjacent to lakes, streams, and wetlands. The Program/Project Management System's Preconstruction Process Documentation Manual discusses specific responsibilities for development of soil erosion and sedimentation controls as they relate to recommended mitigation measures.

Each region has designated staff responsible for identifying locations and quantities for erosion control measures for projects in the region. Soil erosion and sedimentation control items of work must be practical, reasonable and effective during the construction phase of a project in order to prevent off-site sedimentation and ensure adequate protection of the waters of the state.

The project manager will review environmental mitigation commitments and MDEQ permits and will consult with appropriate staff to ensure that additional erosion control measures, pay items, or quantities are included to protect specific areas with highly erodible soils and areas adjacent to lakes, streams, and wetlands. Staff available to the project manager for this consultation includes region soils engineers, drainage engineers, and resource analyst along with Construction and Technology Geoenvironmental Unit staff including the Grading and Drainage Engineer. The project manager will refer to Chapter 9 of the MDOT Drainage Manual for additional design and placement considerations for the various temporary and permanent soil erosion and sedimentation control measures to be incorporated into a project. The contract documents will clearly indicate the location for all appropriate measures.

MDOT Standard Plan R-96 Series Soil Erosion and Sedimentation Control Measures serves as the key to the soil erosion and sedimentation control measures typically used by MDOT. The Soil Erosion and Sedimentation Control (E&S) Details include a brief discussion of appropriate use and application of the measures. The soil erosion and sedimentation control key numbers from Standard Plan R-96 Series will be shown on the plan sheets in the general location where the measure is to be placed in the field. Standard Plan R-96 Series and the E&S Details are included in Section 6 of this manual.

For a log job, the need for erosion control measures will be considered; appropriate erosion control pay items included as required; and an earth change plan prepared for those log jobs involving earth change activities.

The success of erosion control and sediment collection during construction is highly dependent on the measures specified in the contract documents and available for use in the field. By providing a sufficient quantity of erosion control measures with clearly written specifications for their use and payment, MDOT will more readily fulfill the commitment to prevent off right-of-way sedimentation.

2.2.1 Earth Change Plan - Projects/activities that involve an earth disturbance are required by rule R323.1703 to have a soil erosion and sedimentation control plan that includes the following information:

- Scaled drawing of the work site
- Legal description (town, range and section number)
- Site location sketch
- Proximity to lakes and streams
- Predominant land features (including wetlands)
- Slope descriptions or contour intervals
- General description of soil types
- Physical limits of each proposed earth change
- Drainage and/or dewatering features
- Timing and sequence of earth change
- Descriptions and location of temporary and permanent soil erosion control measures
- Maintenance plan for soil erosion control measures

This information is included as part of the plan set and other contract documents for construction projects. When there is no set of plans, as for log jobs and some maintenance projects/activities, this information will be included in the proposal (log jobs), or in the MDOT-approved work methods for a specific earth change activity (maintenance projects). In certain circumstances the earth change plan will be a stand-alone document prepared by MDOT or the Contractor. (Refer to chapter 3 of this manual)

An example of an earth change plan that complies with the SESC rules is included in the Appendix of this manual.

2.2.2 Principles of Earth Change Plan Preparation - Three general principles apply when developing the earth change plan for a project.

- Erosion prevention is generally more effective than sediment control.
- Sediment control is generally more effective and less costly than repairing damage caused by uncontrolled sediment.

- Specific erosion control measures and details are more effective than generalized procedures.

2.2.3 Design Plan Preparation - Guidelines for designing to minimize soil erosion and sedimentation control include the following:

- Design slopes consistent with soil properties.
- Limit the area of unprotected soil exposure.
- Minimize and control concentrated flow rates with temporary and permanent barriers, basins, or other measures.
- Minimize the duration of unprotected soil exposure.
- Protect soil with vegetative cover, mulch, or other erosion resistant material.
- Retard or redirect runoff with engineered devices such as, ditches, dikes, and diversions.
- Trap sediment with temporary or permanent barriers, basins, or other measures as close to the source as possible.

2.2.4 Temporary Erosion Control Measures - Temporary soil erosion and sedimentation control measures will be specified in the contract documents. Temporary measures are used during construction to control erosion and sediment until the disturbed area is stabilized. Temporary measures include those that:

- Provide direct protection of the soil surface (ground cover, turf establishment, and riprap).
- Direct the runoff to an area where concentrated flows will not cause erosion (diversion dikes and ditches).
- Remove sediment from the concentrated flow of waters by filtering or slowing the velocity of the sediment-laden water (gravel filter berms, check dams, and sediment traps).
- Remove sediment from the non-concentrated overland flow of waters by filtering or slowing the velocity of the sediment-laden water (silt fence)

2.2.5 Permanent Erosion Control Measures - Permanent soil erosion and sedimentation control measures will be specified in the contract documents. Permanent measures are placed during construction to minimize erosion and sedimentation in the project area during and after construction. Permanent measures remain in place after construction and may require periodic maintenance to remain effective until the area is stabilized.

2.2.6 Notifications During the Design Phase

- **NPDES Notification for Construction Projects** - For projects disturbing five acres or more and discharging to waters of the state, a Notice of Coverage (NOC) will be prepared by Project Development staff and submitted to the OESE for processing to MDEQ. Projects disturbing one to five acres do not require a NOC. Refer to Section 3.1.1 of this manual for notification requirements for these projects.
- **County Drain Commission Notification** - When work on an MDOT project involves activities within a designated county drain, the Michigan Drain Code requires that Project Development personnel send plans to the County Drain Commissioner.

3. PROJECT DELIVERY

As used in this section, MDOT right-of-way includes areas covered by grading permits where these permits are shown on the plans.

3.1 Construction Projects

Soil erosion and sedimentation control measures selected during the development phase of a project are included in the contract documents. It is the responsibility of the Contractor as well as the Engineer to implement those measures. The Contractor must maintain temporary and permanent erosion control measures during construction until the disturbed area is stabilized or until the contract is closed out. If a disturbed area has not been stabilized at the time the contract is closed out, arrangements will be made for maintaining the erosion control measures until the area is stabilized and for their removal as necessary. As necessary, erosion control measures may be adapted, adjusted, and added to maintain the level of control required to comply with Act 451, and project specific permits.

3.1.1 Notifications for Construction Projects

- **SESC Notification for Construction Projects** - As an APA, MDOT is exempt from obtaining individual SESC permits from the municipal enforcing agency (MEA) or county enforcing agency (CEA). However, MDOT must notify the MEA or CEA of all construction activities that involve earth disturbances within MDOT right-of-way. The complete list of MEA and CEA contacts is available on the MDEQ Web Site at www.michigan.gov/deq. Click on <Land>, then <SESC>, then <SESC Agencies>. Only those agencies listed as MEAs or CEAs will be notified. The APAs and Conservation Districts included on the Web Site do not need to be notified.

NOTE: *Notification to the enforcing agency of the proposed earth change activity on MDOT construction projects is documented by including the agency(s) in the distribution of the minutes of the preconstruction meeting.*

- **NPDES Notification for Construction Projects** - On projects for which a NOC is submitted during the design phase, MDOT will receive a letter of authorization from MDEQ. The Engineer will complete and submit the Notice of Termination (NOT) to the OESE for processing to the MDEQ upon project stabilization.

Projects disturbing one to five acres, and discharging to the waters of the state, do not require a NOC or NOT but must comply with the requirements of Part 31.

3.1.2 Contractor's Operations

- **Off the Right-of-Way** - The Contractor is required to coordinate directly with the landowner to obtain all applicable federal, state, and local permits, including SESC and NPDES permits, when working outside of MDOT right-of-way. The Contractor is responsible for the design and implementation of erosion control measures and for site restoration in areas off MDOT right-of-way. Payment for this restoration will not be included in the contract.

Prior to disturbing any site off MDOT's right-of-way for borrow operations, waste or disposal areas, haul roads, storage sites, or any other earth change activity, the Contractor is responsible for ensuring that all required permits and property owner

agreements are obtained. The Contractor must provide the Engineer copies of these permits and agreements for the project file.

- **On the Right-of-Way but Outside the Limits of Earth Disturbance** - When a Contractor chooses to perform earth change activities within MDOT's right-of-way but outside the limits of earth disturbance the Contractor is responsible for preparing the earth change plan for this work. These activities include, but are not limited to, placement of a portable plant, stockpiling materials, or establishing a haul road. The plan must be submitted to, and approved by, the Engineer prior to the start of the earth change activities. The plan must include all details listed in Section 2.2.1 of this manual.

NOTE: *The Contractor is required to develop an earth change plan unless the only earth change activity undertaken outside the limits of earth disturbance is within the clearing limits as specified by subsection 201 of the standard specifications and as shown on the plans. However, adequate measures must be implemented and maintained to effectively prevent or reduce erosion and subsequent off-site sedimentation that may result from this activity.*

- 3.1.3 Soil Erosion and Sedimentation Control During Construction** - The Engineer will discuss the contract provisions related to soil erosion and sedimentation control with the Contractor prior to the start of related work. The Contractor must not disturb any land or water outside of the limits of earth disturbance but within the project right-of-way or acquired easements without prior authorization from the Engineer and approval of an earth change plan. The plan must include all details listed in section 2.2.1 of this manual. Restoration of any disturbed area beyond the approved limits must be performed by the Contractor - at the Contractor's expense. This work must be completed in accordance with MDOT restoration specifications and as directed by the Engineer.

Construction operations must be conducted in a manner that minimizes erosion and off-site sedimentation. Prior to commencing any construction operation, that constitutes an earth change activity, including clearing; appropriate temporary and permanent erosion and sedimentation control measures must be installed as specified on the plans. Temporary erosion and sedimentation control measures must be installed to minimize potential problems, to correct erosive conditions that develop during construction, and to stabilize inactive construction areas.

- 3.1.4 Time Limitations During Construction** - All grading sections must be brought to final grade as soon as possible. Permanent erosion and sedimentation control for slopes, channels, ditches and other disturbed areas must be completed within five calendar days after final grading or final earth change. Slopes and ditches within 150 feet of a stream, lake or wetland must be permanently restored within 24 hours of final grading or final earth change. A site is considered to be permanently stabilized when all permanent control structures have been installed, maintenance for the permanent controls has been arranged, vegetation is well established, and temporary controls have been removed.

If it is not possible to permanently stabilize a disturbed area after an earth change has been completed or if significant earth change activity ceases, then temporary soil erosion and sedimentation control measures must be maintained until permanent soil erosion and sedimentation control measures are in place and the area is stabilized.

Refer to subsection 208.03.B of the Standard Specifications for Construction for additional information on time limitations.

3.1.5 Inspections During Construction - SESC regulations require that temporary erosion control measures be maintained daily. SESC regulations do not explicitly call for regularly scheduled inspections. NPDES regulations require regular inspection and documentation of the condition and effectiveness of soil erosion and sedimentation control measures on earth change activities one or more acres in size and discharging to the waters of the state.

At a minimum, inspection of all soil erosion and sedimentation control measures and devices will be completed once per week and within 24 hours after every precipitation event that results in a discharge from the right-of-way. If an area is temporarily stabilized, as discussed in section 3.1.4 above, inspections will continue in the temporarily stabilized areas to ensure the adequacy of the temporary measures. These inspections will continue until the disturbed area is permanently stabilized.

The need for corrective actions will be documented and followed up on to ensure the actions are carried out. When needed, corrective action is required within 24 hours of the inspection if sediment is discharging to the waters of the state and within 5 days of the inspection in all other circumstances.

These inspections and corrective actions will be documented using the National Pollutant Discharge Elimination System and Soil Erosion and Sedimentation Control Inspection Report (Form 1126). Deficiencies, including a deadline for completing the corrective actions, will be brought to the attention of the Contractor. This notice may be made by providing a copy of Form 1126 to the Contractor with any corrective actions and related deadlines indicated under "Remarks". A log of the inspections and corrective actions will be placed in the project file and will be retained for a period of three years from the date of the inspection.

Completed corrective action will be documented in the project file with reference to the appropriate inspection report(s). If corrective actions are not completed within the specified timeframe, the steps outlined in Section 4 of this manual will be initiated. All resulting documentation placed in the file will also be referenced to the appropriate inspection report(s).

3.2 Maintenance Projects and Maintenance Activities

Some maintenance operations have potential for impact on lakes, streams, and wetlands. MDOT will conduct maintenance projects and activities in a manner that minimizes potential for soil erosion and off right-of-way sedimentation and will incorporate applicable soil erosion and sedimentation control measures included in this manual.

Appropriate SESC measures and NPDES requirements will be included when planning, designing, and completing maintenance projects and activities involving earth disturbances, regardless of size and location. An earth change plan, as described in section 2.2.1 of this manual, will be prepared for all maintenance projects and activities involving earth disturbances unless an alternate process has been approved by the MDEQ for a specific maintenance activity.

NOTE: *The environmental procedures for ditch clean-out (Activity #12300), included in the Appendix of this manual, is the only MDOT- approved work method for a specific earth change activity at this time.*

Permits are necessary for activities related to draining, dredging or filling a wetland, floodplain, lake or stream. Other MDEQ and/or U.S. Army Corp of Engineer permits may be necessary. Contact appropriate MDOT staff to determine the need for additional permits prior to the start of a maintenance project or activity.

3.2.1 Notifications for Maintenance Projects and Activities

- **SESC Notification for Maintenance Projects and Activities** - As an APA, MDOT is exempt from obtaining individual SESC permits from the MEA or CEA. However, MDOT must notify the MEA or CEA prior to the start of maintenance projects and activities involving earth change activities. The complete list of MEA and CEA contacts is available on the MDEQ Web Site at www.michigan.gov/deq. Click on <Land>, then <SESC>, then <SESC Agencies>. Only those agencies listed as an MEA or CEA need to be notified. The APAs and Conservation Districts included on the Web Site do not need to be notified.

NOTE: *An annual notice can be provided to the MEA/CEA to cover projects and activities planned for the coming year. An individual notice will be required for projects and activities added to the program after the annual notice.*

- **County Drain Commission Notification for Maintenance Projects** - When a MDOT maintenance project or activity involves work within a designated county drain, the Michigan Drain Code requires notification of the County Drain Commissioner prior to the start of work.
- **NPDES Notice of Coverage for Maintenance Projects** - For projects and activities disturbing five acres or more and discharging to the waters of the state, a Notice of Coverage (NOC) will be prepared and submitted to the OESE for processing to MDEQ.

On projects and activities for which a NOC is submitted, MDOT will receive a letter of authorization from MDEQ. The TSC maintenance supervisor/coordinator, or designee, will complete and submit the Notice of Termination (NOT) upon stabilization of the affected area.

Projects and activities disturbing one to five acres, and discharging to the waters of the state, do not require a NOC or NOT but must comply with the requirements of Part 31.

3.2.2 Soil Erosion and Sedimentation Control for Maintenance Projects and Activities -

Maintenance projects and activities that involve earth changes will be conducted in a manner that minimizes soil erosion and off-site sedimentation. Before starting any maintenance project or activity involving earth changes, appropriate erosion and sedimentation control measures will be installed. Temporary soil erosion and sedimentation control measures will be installed to minimize potential problems, to correct erosive conditions that develop during the maintenance operation, and to stabilize inactive work areas. All necessary erosion control measures will be maintained until disturbed areas are stabilized.

3.2.3 Time Limitations for Maintenance Projects and Activities - Permanent soil erosion and sedimentation control measures for all slopes, channels, ditches, or any disturbed land area will be complete within five calendar days after final grading or the final earth change is complete. If it is not possible to permanently stabilize a disturbed area after an earth change is complete or if significant earth change activity ceases, temporary soil erosion and sedimentation control measures will be maintained until permanent soil erosion and sedimentation control measures are in place and the area is stabilized.

3.2.4 Inspections for Maintenance Projects and Activities - SESC regulations require that temporary erosion control measures be maintained daily. SESC regulations do not explicitly call for regularly scheduled inspections. NPDES regulations require regular inspection and documentation of the condition and effectiveness of soil erosion and sedimentation control measures on earth change activities one or more acres in size and discharging to the waters of the state.

At a minimum, inspection of all soil erosion and sedimentation control measures and devices will be completed once per week and within 24 hours after every precipitation event that results in a discharge from the right-of-way. If an area is temporarily stabilized, as discussed in section 3.2.2 above, inspections will continue in the temporarily stabilized areas to ensure the adequacy of the temporary measures. These inspections will continue until the disturbed area is permanently stabilized.

The need for corrective actions will be documented and followed up on to ensure the actions are carried out. When needed, corrective action is required within 24 hours of the inspection if sediment is discharging to the waters of the state and within 5 days of the inspection in all other circumstances.

This inspection may be documented using the National Pollutant Discharge Elimination System and Soil Erosion and Sedimentation Control Inspection Report (Form 1126) and the notice may be made by providing the Contractor or appropriate Maintenance staff with a copy of Form 1126 with any corrective actions and related deadlines indicated under "Remarks." A log of the inspections and corrective actions will be maintained on file at the TSC for review and will be retained for a period of three years from the date of the inspection.

Alternate methods of documenting inspections must be approved by the maintenance supervisor/coordinator or other individual designated by the TSC Manager or Region Engineer. Regardless of the form or format used, all documentation of erosion and sedimentation control inspections must be retained for a period of three years from the date of the inspection.

3.2.4 Maintenance Performance Guides - Operational guidelines for maintenance activities are described in the performance guides found on MDOT's Maintenance Activity Reporting System (MARS) Web Site. The ditch clean-out activity has been identified as the most common maintenance activity subject to SESC and NPDES regulations and therefore is included in the Appendix for reference. The procedures for minimizing soil erosion and sedimentation described in the ditch clean-out performance guide will be followed in lieu of preparation of individual earth change plans.

THIS PAGE BLANK

4. COMPLIANCE AND ENFORCEMENT

During the course of construction and maintenance of transportation facilities, even well designed and properly placed erosion control measures can fail to perform as originally expected. Compliance and enforcement actions may be necessary to ensure that erosion control measures are implemented or improved to preserve the natural resources of the State of Michigan and to prevent off-site sedimentation.

Subsections 4.1 and 4.2 identify options available to MDOT when progressive enforcement of the contract becomes necessary to correct and/or prevent soil erosion and sedimentation control problems. Current Department specifications, procedures, and guidance documents will be followed when implementing any of the actions listed in subsections 4.1 and 4.2. Subsection 4.3 identifies coordination efforts with MDEQ to resolve on-going soil erosion and sedimentation control issues.

The Department's goal is not to wait until MDEQ has to get involved before taking steps to bring the project into compliance with the approved MDOT SESC program. A successful and effective APA program is one in which MDEQ is not relied upon to provide the level of enforcement needed to ensure compliance with our program. All compliance and enforcement actions will be documented carefully so that in the event that a Contractor claim results, the Department will have the necessary information to determine the validity of the claim. This documentation will also be used to support the Contractor Performance Evaluation for the environmental category.

4.1 Construction Projects

MDOT contracts will be enforced to ensure the Contractor installs, inspects, and maintains appropriate soil erosion and sedimentation control measures in the field. Depending on the site and contract specific issues, the Engineer will determine the appropriate and progressive compliance and enforcement actions, including but not limited to the following. (Ref. Standard Specifications for Construction sections 108 and 109; MDOT Construction Manual section 103 and 208).

The first action is always to conduct adequate inspections throughout the project. If necessary, communicate deficiencies to the Contractor with specific actions that must be taken to repair, replace or modify SESC measures.

4.1.1 Minor Deficiencies

- Conditions of SESC measures observed by any Department employee can be noted on the IDR and brought to the Contractor's attention (project staff) or brought to the attention of the project Engineer (non-project staff).
- Use Form 1126 to document the condition, effectiveness and need for additional SESC measures during required inspections.
- Contact region or Lansing staff with responsibility for SESC activities to discuss methods to improve site specific soil erosion and sedimentation control.
- If a MDEQ field inspector visits the site, use this opportunity to get their input on methods to effectively minimize erosion and reduce off-site sedimentation.

4.1.2 Moderate and Continuing Problems When taking any of the following actions, provide as much detail as necessary to convey the scope of the problem and the required action to bring the site into compliance.

- Issue a Work Order (Form 1137) directing the Contractor to correct deficiencies in a specified time frame.
- Issue Notice of Non-Compliance with Contract Requirements (Form 1165)
- Withhold payment for erosion control devices, erosion control maintenance and/or related items of work
- Report deficiencies using interim and final Contractor Performance Evaluations (Form 1182) Refer to the rating guidance included in the MDOT Construction Manual for this item. The guidance current at the time of approval of this manual is included here for reference. Always refer to the most current Department guidance on this subject when completing Form 1182.

14. To what degree does the Contractor meet the environmental requirements of the contract?

Rating of 10: The Contractor exceeds the environmental requirements and provides required documentation without prompting by the Engineer.

Rating of 8: The Contractor meets the environmental requirements and provides required documentation without prompting by the Engineer.

Rating of 5: The Contractor meets the environmental requirements and provides required documentation only after notification by the Engineer.

Rating of 1: The Contractor meets environmental requirements only after repeated notification from the Engineer. The Engineer may issue orders to stop work, hold up payments, or have work completed by others.

4.1.3 Severe and Non-Responsive - These steps require advice and consent from one or more of the following: TSC Manager, Region Associate Engineer for Delivery, Region Engineer and the Assistant Attorney General – Transportation.

- Arrange for others to perform the work.
- Involve the performance bond company.
- Place the contract in default.

4.2 Maintenance Projects and Activities

Maintenance work involving earth change activities performed by direct forces, contract agencies, or Contractors will incorporate appropriate soil erosion and sedimentation control measures. The Part 91 Inspector is responsible for compliance and enforcement on these projects. In the event that progressive compliance and enforcement is necessary, the Part 91 Inspector will work with Maintenance Supervisors/Coordinators and Maintenance Superintendents, and, if necessary, TSC Managers to seek appropriate action as follows:

4.2.1 Direct Forces Work - Minor to Moderate

- Issue directions to staff to correct deficiencies in a specified time frame; follow up to ensure corrective action has been completed.
- Arrange additional staff training on proper work methods and the importance of soil erosion and sedimentation control.
- Arrange for others to perform the work.

4.2.2 Contract Agency Work - Minor to Moderate

- Issue work orders (Form 1137) to correct deficiencies in a specified time frame; follow up to ensure corrective action has been completed.
- Arrange additional agency training on proper work methods and the importance of soil erosion and sedimentation control.

4.2.3 Contract Agency Work – Severe - These steps require advice and consent from one or more of the following: Maintenance Superintendent, TSC Manager, Region Associate Engineer for Delivery, Region Engineer and possibly the Assistant Attorney General – Transportation.

- Withhold payment.
- Issue stop work notices.
- Arrange for others to perform the work.
- Terminate the agency's maintenance contract.

4.2.4 Contractor Work - Use actions described above for construction projects experiencing minor to moderate SESC problems. Follow the Department's Vendor Performance process to document unsatisfactory performance of the work. This process is similar to the Contractor Evaluation for Construction projects. If the Contractor is non-responsive and the problem is severe, take steps necessary to terminate the contract and arrange for others to perform the work.

4.3 MDEQ Progressive Compliance (Escalation) Process

Every effort will be made to resolve soil erosion and sedimentation control issues as quickly as possible rather than wait for MDEQ to issue a Notice Letter.

If progressive compliance involving MDEQ becomes necessary, the process shown in the flow chart at the end of this section will be followed by MDEQ and MDOT. It may not be necessary to follow each step in the order shown provided the appropriate actions are taken in order to minimize the impacts to the environment and to bring the work area into compliance.

The TSC Manager will work to resolve the concerns as expeditiously as possible and in a time frame that is mutually agreed upon by MDEQ and the TSC Manager. TSC staff may work with designated region and Lansing central office staff to make the best decisions possible to improve deficient erosion control measures. If additional information is required, MDEQ may arrange a site meeting with the TSC staff. TSC staff will invite region resource staff and, if necessary, Lansing central office staff to this meeting.

When written correspondence is advised or required, e-mail or formal letters are acceptable. When formal correspondence is necessary, this correspondence may be sent electronically to save time but must be followed up with a signed hard copy. All correspondence will be copied to the appropriate Region Engineer and the Operations Environmental Stewardship Engineer at Construction & Technology.

MDOT SESC COMPLIANCE PROCESS

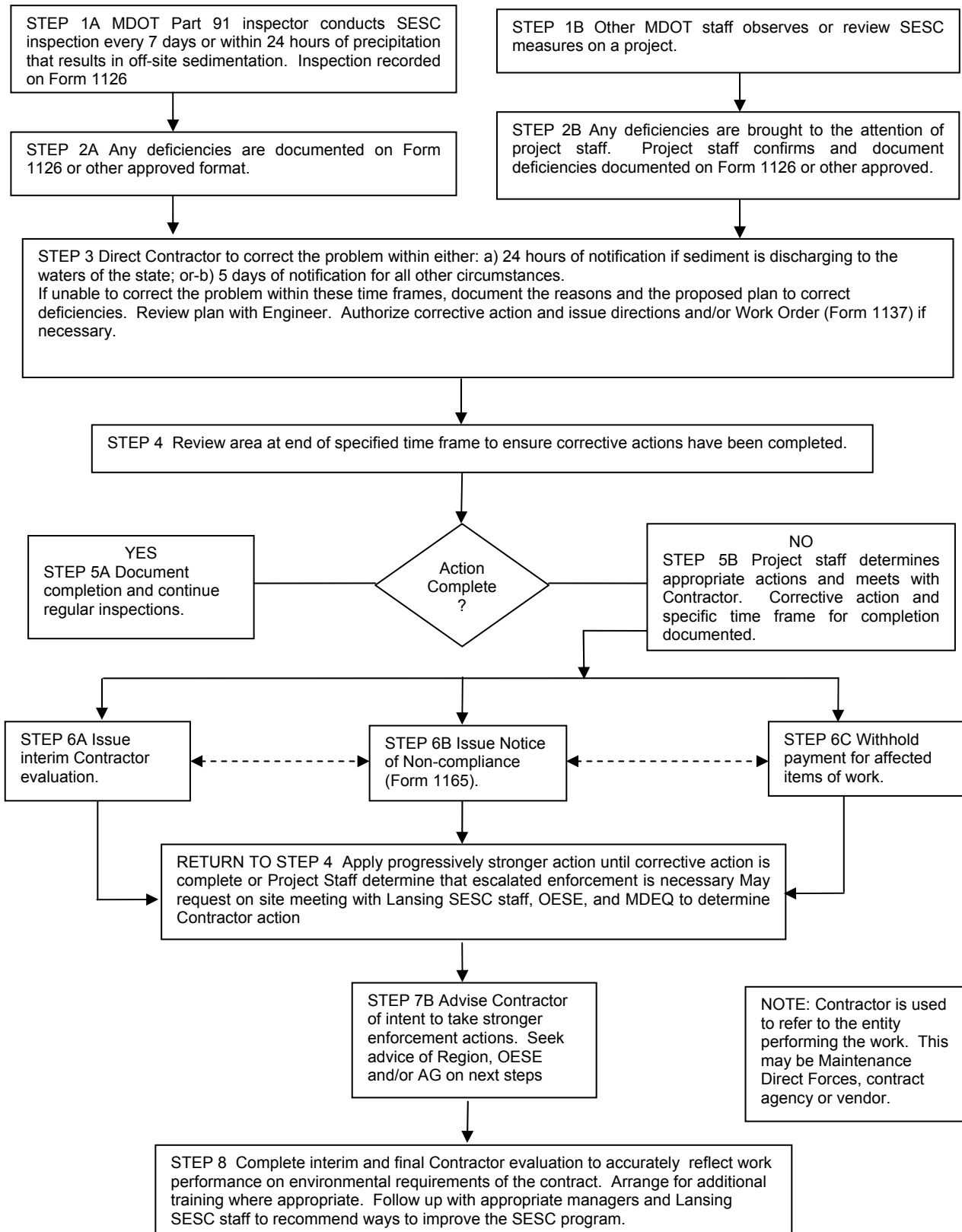

MDEQ SESC PROGRESSIVE COMPLIANCE PROCESS

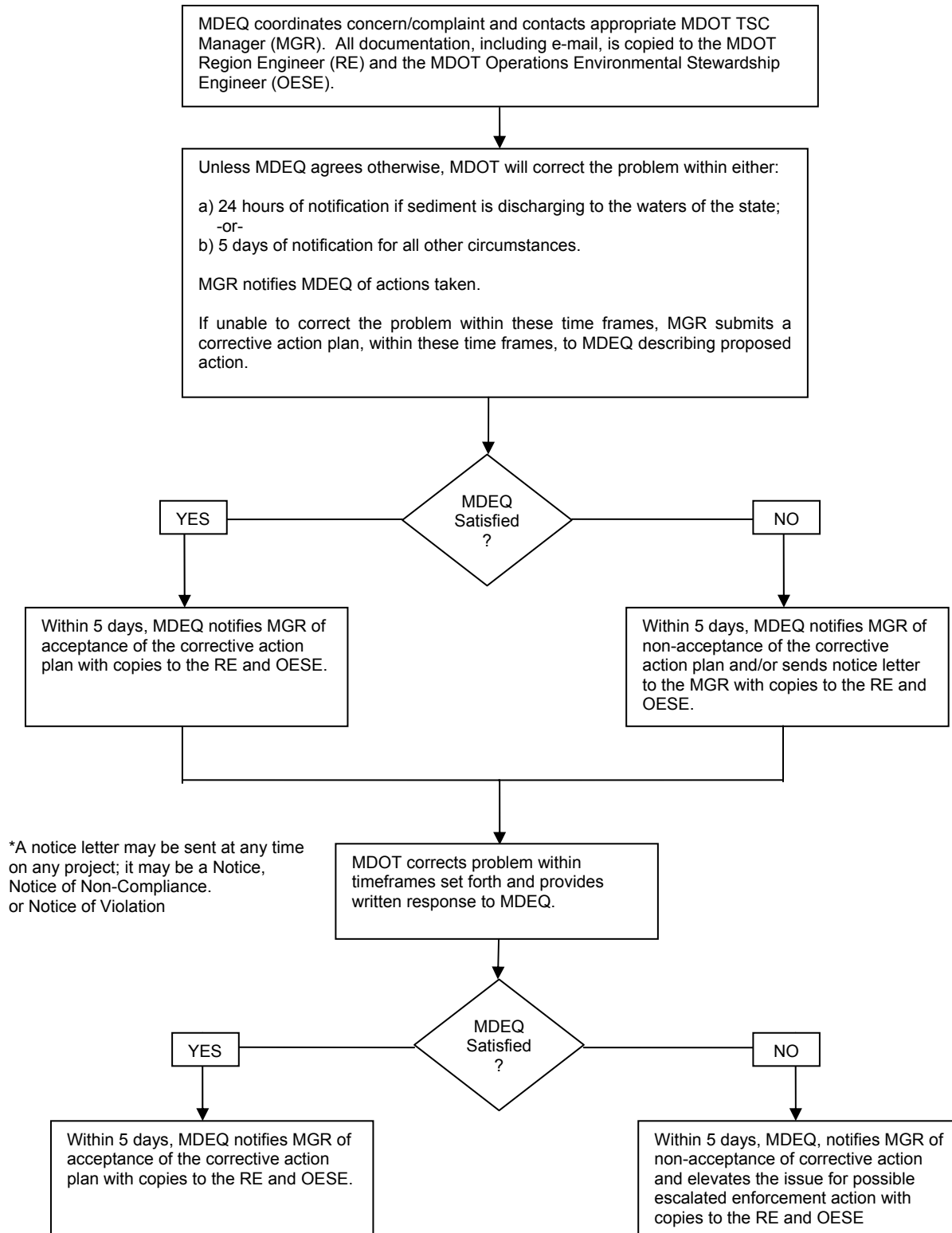

THIS PAGE BLANK

5. PERMIT REQUIREMENTS, ACTS AND RULES

This section contains information on additional permits that may be required on MDOT construction or maintenance projects. Always consult with designated staff in the region, TSC or Lansing central office on project specific permit requirements.

The full text of Parts 31 and 91 of act 451 and the related administrative rules, Parts 21 and 17, respectively, are found on the MDEQ web site.

Part 91 and Part 17 (SESC)

http://www.michigan.gov/deq/0,1607,7-135-3311_4113---,00.html

Part 31 and Part 21 (NPDES)

http://www.michigan.gov/deq/0,1607,7-135-3313_4117-9765--,00.html

5.1 MDOT Permit Coordinators

When an activity conducted by MDOT requires a permit from MDEQ under state and/or federal statutes it will be coordinated in the following manner.

Permit acquisition for projects located in the Grand Region will be coordinated by the Environmental Permit Coordinator of the MDOT Grand Region Office at 1420 Front Ave. N.W., Grand Rapids, MI 49504, Phone: 616-451-3091.

Permit acquisition for projects located in the University and North Regions will be coordinated by the Environmental Permit Coordinator of the MDOT University Region Office at 4701 W. Michigan Ave., Jackson, MI 49201, Phone: 517-750-0401.

Permit acquisition for projects located in the Bay and Metro Regions will be coordinated by the Environmental Permit Coordinator of the MDOT Bay Region Office at 55 Morley Drive Saginaw, MI 48601, Phone: 989-754-7443.

Permit acquisition for projects located in the Southwest Region will be coordinated by the Environmental Permit Coordinator of the MDOT Southwest Region Office at 1501 E. Kilgore Road, Kalamazoo, MI 49009, Phone: 269-337-3900.

Permit acquisition for projects located in the Superior Region will be coordinated by the Environmental Permit Coordinator of the MDOT Superior Region Office at 1818 Third Avenue North, Escanaba, MI 49829, Phone: 906-786-1800.

This coordinated approach will ensure compliance with the current state and federal permit requirements and allow for efficient processing of MDOT applications by MDEQ.

5.2 Permit Requirements

One or more of the following permits may be required for a construction project, maintenance project or maintenance activity.

5.2.1 Floodplain and Floodways - Part 31 of Act 451 requires a Floodplain Permit from MDEQ for construction in a floodplain of any river or stream having a contributing

drainage area of two square miles or more upstream of the crossing. In addition, MDOT must comply with the Governor's State Executive Order 1977-4, "State Flood Hazard Management Plan" which establishes flood standards and design requirements.

- 5.2.2 Inland Lakes and Streams** - Part 301 of Act 451 requires an Inland Lakes and Streams Permit from MDEQ for construction in, over or adjacent to inland lakes or streams.
- 5.2.3 Wetland Protection** - Part 303 of Act 451 requires a state wetland permit from MDEQ for construction in wetland areas. Any unavoidable wetland impacts resulting from construction activities in a regulated wetland must be properly mitigated based on specific ratios. Wetland mitigation plans must be developed and coordinated with MDEQ during the project development stage.
- 5.2.4 Dam Safety** - Part 315 of Act 451 requires a Dam Safety permit from MDEQ for construction, enlargement, repair, reconstruction, alteration, removal or abandonment of any dam in the State of Michigan.
- 5.2.5 Shorelines Protection and Management** - Part 323 of Act 451 may require a permit for work in MDEQ designated high-risk erosion areas, environmental areas, and flood risk areas. Such work includes erection of permanent structures in designated high-risk erosion areas or flood plain areas, or grading, dredging and filling in designated environmental areas.
- 5.2.6 Great Lakes Submerged Lands** - Part 325 of Act 451 requires a Great Lakes Submerged Land permit from MDEQ for any dredging, filling or related construction activities in, over, or adjacent to any of the Great Lakes.
- 5.2.7 Sand Dunes Protection and Management** - Part 353 of Act 451 may require MDEQ permits for uses in critical dunes areas, as designated by the MDEQ, which would include grading, filling or excavating activity.
- 5.2.8 Section 404C (Federal)** - The Federal 404 Permit Program of the Clean Water Act authorizes coordination of federal permits under the joint permit system with the U.S. Army Corps of Engineers (USACE). MDEQ is the responsible agency for this coordination of permits. A separate permit from the USACE is required for navigable watercourses.

6. SESC MEASURES (E & S DETAILS)

This section contains the current MDOT soil erosion and sedimentation control measures for use on construction and maintenance projects. All measures shown reflect MDOT's experience with soil erosion and sedimentation control for road and bridge construction and, as such, are considered best management practices. Additional design and placement considerations for these measures are found in Chapter 9 of the MDOT Drainage Manual.

Refer to Standard Plan R-96 Series for the key numbers to be shown on plan sheets and information on when to use various control measures. Discussion of measurement and payment is included on the E&S details for information only. In the case of conflict between the contract items shown on these details and contract items included in the contract documents for a specific project, the contract documents will prevail.

Dimensions on E&S Details not shown as maximum or minimum dimensions may be modified to fit existing field conditions or to improve the effectiveness of the soil erosion or sedimentation control of the device. Dimensions shown as maximum or minimum dimensions must be adhered to unless modifications are discussed with region or Lansing SESC staff and approved changes are noted in the inspection reports. The designer and project engineer will determine the need for all items shown as optional on the E&S Details. Refer to the contract documents for additional information on the materials, construction or placement of these devices.



Individual erosion control devices will be constructed to provide the most effective and efficient soil erosion and sedimentation control for a specific construction or maintenance site. Based on site conditions, the Engineer or the Part 91 Inspector may authorize minor adjustments to the E&S Details. Any major deviations, especially in areas of concentrated flows, will be discussed with the appropriate staff and approved changes must be noted in the inspection reports. Prior review and approval is not required if the changes are needed to mitigate the effects of a pending sediment release.

THIS PAGE BLANK



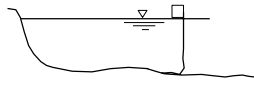
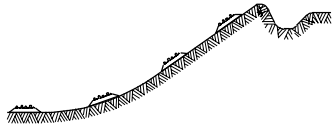

APPLICABLE SOIL EROSION AND SEDIMENTATION CONTROL MEASURES
 (COMPREHENSIVE DETAILS ARE LOCATED IN SECTION 7 OF)
 (THE SOIL EROSION & SEDIMENTATION CONTROL MANUAL)

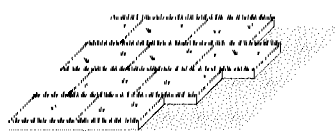
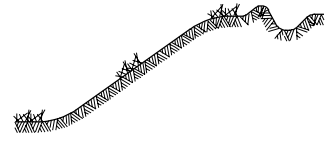
- A = SLOPES
- B = STREAMS AND WATERWAYS
- C = SURFACE DRAINAGEWAYS
- D = ENCLOSED DRAINAGE (INLET & OUTFALL CONTROL)
- E = LARGE FLAT SURFACE AREAS
- F = BORROW AND STOCKPILE AREAS
- G = MDEQ PERMIT MAY BE REQUIRED

KEY	DETAIL	CHARACTERISTICS	A	B	C	D	E	F	G
1	 TURBIDITY CURTAIN	A Turbidity Curtain is used when slack water area is necessary to isolate construction activities from the watercourse. The still water area contains the sediments within the construction limits.		•					
2	 GRUBBING OMITTED	Retains existing root mat which assists in stabilizing slopes. Assists in the revegetation process by providing sprout growth. Reduces sheet flow velocities preventing rilling and gullyng. Discourages off-road vehicle use.		•			•		
3	 PERMANENT/TEMPORARY SEEDING	Inexpensive but effective erosion control measure to stabilize flat areas and mild slopes. Permits runoff to infiltrate soil, reducing runoff volumes. Proper preparation of the seed bed, fertilizing, mulching and watering is critical to its success.		•	•		•	•	
4	 DUST CONTROL	Dust control can be accomplished by watering, and/or applying calcium chloride. The disturbed areas should be kept to a minimum. PERMANENT/TEMPORARY SEEDING (KEY 3) should be applied as soon as possible.		•			•	•	
5	 SODDING	Provides immediate vegetative cover such as at spillways and ditch bottoms. Proper preparation of the topsoil, placement of the sod, and watering is critical to its success.		•			•	•	
6	 VEGETATED BUFFER STRIPS	Reduces sheet flow velocities preventing rilling and gullyng. Assists in the collection of sediments by filtering runoff. Assists in the establishment of a permanent vegetative cover.		•			•		

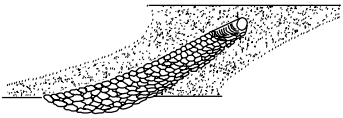
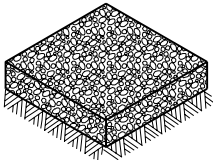
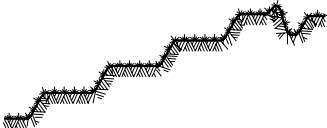
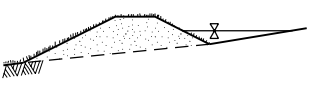
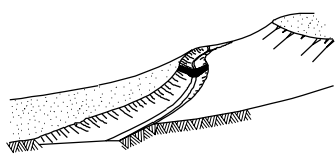
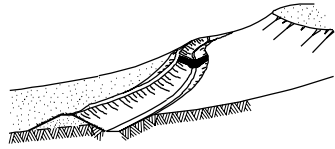
 PREPARED BY DESIGN SUPPORT AREA	ENGINEER OF CONSTRUCTION & TECHNOLOGY	ENGINEER OF DESIGN SUPPORT AREA DEPARTMENT DIRECTOR Gloria J. Jeff	MICHIGAN DEPARTMENT OF TRANSPORTATION BUREAU OF HIGHWAY DEVELOPMENT STANDARD PLAN FOR			
	ENGINEER OF MAINTENANCE		SOIL EROSION & SEDIMENTATION CONTROL MEASURES			
DRAWN BY: <u>B.L.T.</u> CHECKED BY: <u>W.K.P.</u>	ENGINEER OF TRAFFIC AND SAFETY	ENGINEER OF DEVELOPMENT	F.H.W.A. APPROVAL	3-20-2003 PLAN DATE	R-96-D	SHEET 1 OF 6

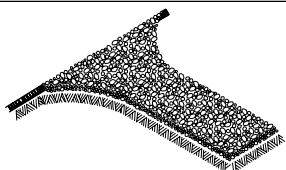
KEY	DETAIL	CHARACTERISTICS	A	B	C	D	E	F	G
7	 <p>RIPRAP</p>	Used where vegetation cannot be established. Very effective in protecting against high velocity flows. Should be placed over a geotextile blanket.	•	•	•	•			•
8	 <p>AGGREGATE COVER</p>	Can be used in any area where a stable condition is needed for construction operations, equipment storage or in heavy traffic areas. Reduces potential soil erosion and fugitive dust by stabilizing raw areas.	•				•	•	
9	 <p>BENCHES</p>	Reduces sheet flow velocities preventing rilling and gulying. Assists in the collection and filtering of sediments. Provides access for stabilizing slopes.	•						•
10	 <p>DIVERSION DIKE</p>	Assists in the diversion of runoff to a stable outlet or sediment control device. Reduces sheet flow velocities preventing rilling and gulying. Collects and diverts runoff to properly stabilized drainage ways. Works well with INTERCEPTING DITCH (KEY 11)	•				•	•	
11	 <p>INTERCEPTING DITCH</p>	Assists in the diversion of runoff to a stable outlet or sediment control device. Reduces sheet flow velocities preventing rilling and gulying. Works well with DIVERSION DIKE (KEY 10)	•				•	•	
12	 <p>INTERCEPTING DITCH AND DIVERSION DIKE</p>	Assists in the diversion of runoff to a stable outlet or sediment control device. Reduces sheet flow velocities preventing rilling and gulying.	•				•	•	
13	 <p>GRAVEL FILTER BERM</p>	Useful in filtering flow prior to its reentry into a lake, stream or wetland. Works well with SEDIMENT TRAP (KEY 20) and TEMPORARY BYPASS CHANNEL (KEY 35). Not to be used in lieu of a CHECK DAM (KEY 37) in a ditch.	•		•				•
14	 <p>GRAVEL ACCESS APPROACH</p>	Provides a stable access to roadways minimizing fugitive dust and tracking of materials onto public streets and highways.						•	•

MICHIGAN DEPARTMENT OF TRANSPORTATION
BUREAU OF HIGHWAY DEVELOPMENT STANDARD PLAN FOR





SOIL EROSION & SEDIMENTATION
CONTROL MEASURES

F.H.W.A. APPROVAL

3-20-2003
PLAN DATE

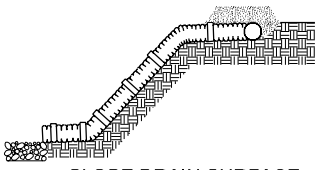
R-96-D

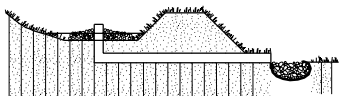
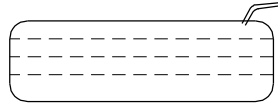
SHEET
2 OF 6

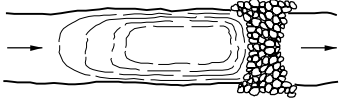
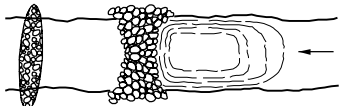
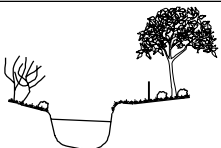
KEY	DETAIL	CHARACTERISTICS	A	B	C	D	E	F	G
15	 <p>SLOPE DRAIN SURFACE</p>	<p>Excellent device for carrying water down slopes without creating an erosive condition.</p> <p>Generally used in conjunction with DIVERSION DIKE (KEY 10), INTERCEPTING DITCH (KEY 11) and INTERCEPTING DITCH AND DIVERSION DIKE (KEY 12) to direct flow to a stable discharge area or SEDIMENT TRAP (KEY 20).</p>		•		•			
16	 <p>TREES, SHRUBS, VINES AND GROUNDCOVER</p>	<p>Trees, shrubs, vines and groundcover can provide low maintenance long term erosion protection. These plants may be particularly useful where site aesthetics are important along the roadside slopes.</p>		•				•	
17	 <p>PIPE DROP</p>	<p>Effective way to allow water to drop in elevation very rapidly without causing an erosive condition.</p> <p>Also works as a sediment collector device.</p> <p>May be left in place as a permanent erosion control device.</p>		•		•			
18	 <p>DEWATERING BY FILTER BAG / SEDIMENT BASIN</p>	<p>It may be necessary to dewater from behind a cofferdam or construction dam to create a dry work site.</p> <p>Discharged water must be pumped to a filter bag.</p> <p>A GRAVEL FILTER BERM (KEY 13) may be placed downslope of the filter bag to provide additional filtration prior to entering any stream or wetland.</p>			•				•
19	 <p>ENERGY DISSIPATORS</p>	<p>A device to prevent the erosive force of water from eroding soils.</p> <p>Used at outlets of culverts, drainage pipes or other conduits to reduce the velocity of the water.</p> <p>Prevents structure scouring and undermining.</p>		•	•	•	•		
20	 <p>SEDIMENT TRAP</p>	<p>Used to intercept concentrated flows and prevent sediments from being transported off site or into a watercourse or wetland.</p> <p>The size of a Sediment Trap is 5 cubic yards or less.</p> <p>Works well when used with CHECK DAM (KEY 37).</p>		•		•	•		
21	 <p>SEDIMENT BASIN</p>	<p>A Sediment Basin is used to trap sediments from an upstream construction site.</p> <p>Requires periodic inspections, repairs, and maintenance.</p> <p>Where practical, sediments should be contained on site.</p> <p>A Sediment Basin should be the last choice of sediment control.</p> <p>The size of a Sediment Basin is greater than 5 cubic yards.</p>			•				•
22	 <p>VEGETATIVE BUFFER AT WATERCOURSE</p>	<p>This practice is used to maintain a vegetative buffer adjacent to a watercourse.</p> <p>When utilized with GEOTEXTILE SILT FENCE (KEY 26) it will prevent siltation from leaving the construction site.</p>		•	•	•		•	•

MICHIGAN DEPARTMENT OF TRANSPORTATION
BUREAU OF HIGHWAY DEVELOPMENT STANDARD PLAN FOR



**SOIL EROSION & SEDIMENTATION
CONTROL MEASURES**

F.H.W.A. APPROVAL

3-20-2003
PLAN DATE

R-96-D

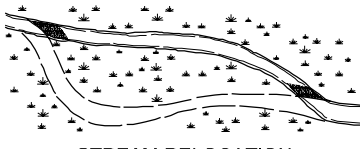
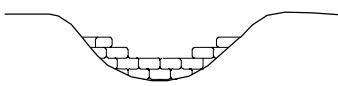
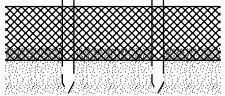
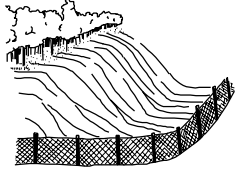
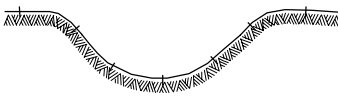
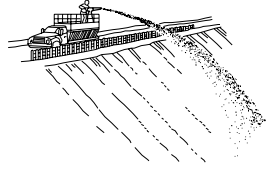
SHEET
3 OF 6

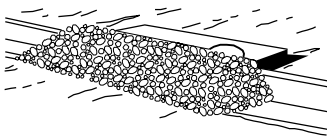
KEY	DETAIL	CHARACTERISTICS	A	B	C	D	E	F	G
23	 <p>STREAM RELOCATION</p>	A detail depicting the proper procedures for STREAM RELOCATION. Maintains same width, depth, and flow velocity as the natural stream. Revegetate banks with RIPRAP (KEY 7), PERMANENT/TEMPORARY SEEDING (KEY 3), MULCH BLANKETS AND HIGH VELOCITY MULCH BLANKETS (KEY 33) and woody plants to shade the stream.		•					•
24	 <p>SAND AND STONE BAGS</p>	Sand and stone bags are a useful tool in the prevention of erosion. Can be used to divert water around a construction site by creating a DIVERSION DIKE (KEY 10). Works well for creating a CONSTRUCTION DAM (KEY 36) and temporary culvert end fill.	•	•	•	•	•	•	•
25	 <p>SAND FENCE AND DUNE STABILIZATION</p>	A Sand Fence traps blowing sand by reducing wind velocities. Can be used to prevent sand from blowing onto roads. Must be maintained until sand source is stabilized.	•				•	•	
26	 <p>GEOTEXTILE SILT FENCE</p>	A permeable barrier erected below disturbed areas to capture sediments from sheet flow. Can be used to divert small volumes of water to stable outlets. Ineffective as a filter and should never be placed across streams or ditches where flow is concentrated.	•				•	•	
27	 <p>PLASTIC SHEETS OR GEOTEXTILE COVER</p>	Plastic Sheets can be used to create a liner in temporary channels. Can also be used to create a temporary cover to prevent erosion of stockpiled materials.	•	•	•				•
28	 <p>MULCHING AND MULCH ANCHORING</p>	Anchored mulch provides erosion protection against rain and wind. Mulch must be used on seeded areas to promote water retention and growth. Should be inspected after every rainstorm and repaired as necessary until vegetation is well established.	•		•		•	•	
29	 <p>INLET PROTECTION FABRIC DROP</p>	Provides settling and filtering of silt laden water prior to its entry into the drainage system. Can be used in median and side ditches where vegetation will be disturbed. Allows for early use of drainage systems prior to project completion.			•		•		
30	 <p>INLET PROTECTION GEOTEXTILE AND STONE</p>	Provides settling and filtering of silt laden water prior to its entry into the drainage system. Should be used in paved areas where drainage structures are existing or proposed. Allows for early use of drainage systems prior to project completion.			•		•		

MICHIGAN DEPARTMENT OF TRANSPORTATION
BUREAU OF HIGHWAY DEVELOPMENT STANDARD PLAN FOR





**SOIL EROSION & SEDIMENTATION
CONTROL MEASURES**

F.H.W.A. APPROVAL

3-20-2003
PLAN DATE

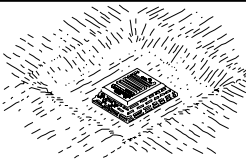
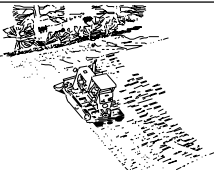
R-96-D

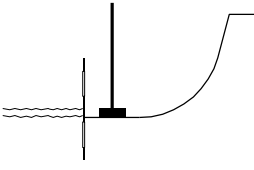
SHEET
4 OF 6

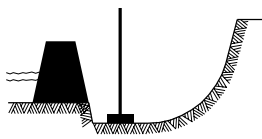
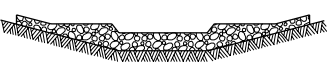
KEY	DETAIL	CHARACTERISTICS	A	B	C	D	E	F	G
31	 <p>DROP INLET SEDIMENT TRAP</p>	<p>A Drop Inlet Sediment Trap is a temporary device that can be used in areas where medium flows are anticipated. Effective in trapping small quantities of sediments prior to water entering the drainage system. Can be used in areas such as median and side ditches.</p>			•		•		
32	 <p>SLOPE ROUGHENING AND SCARIFICATION</p>	<p>A simple and economical way to reduce soil erosion by wind and water. Can be accomplished by harrowing with a disk, back blading, or tracking with a dozer perpendicular to the slope.</p>	•				•	•	
33	 <p>MULCH BLANKETS AND HIGH VELOCITY MULCH BLANKETS</p>	<p>Mulch blankets provide an immediate and effective cover over raw erodible slopes affording excellent protection against rain and wind erosion. High velocity mulch blankets work well for stabilizing the bottom of ditches in waterways.</p>	•		•		•	•	
34	 <p>COFFERDAM</p>	<p>Used to create a dry construction site and protect the stream from raw erodible areas. Must be pumped dry or dewatered according to DEWATERING BY FILTER BAG / SEDIMENT BASIN (KEY 18).</p>		•					•
35	 <p>TEMPORARY BYPASS CHANNEL</p>	<p>Utilized when a dry construction area is needed. Isolates and protects stream flows from raw erodible areas minimizing erosion and subsequent siltation. Can incorporate a large SEDIMENT BASIN (KEY 21) and multiple GRAVEL FILTER BERMS (KEY 13) to remove sediments from water. Construction sequence of events.</p>		•					•
36	 <p>CONSTRUCTION DAM</p>	<p>Used to create a dry or slack water area for construction. Protects the stream from raw erodible areas. Can be created out of any non-erodible materials such as SAND AND STONE BAGS (KEY 24), a gravel dike with clay core or plastic liner, steel plates or plywood.</p>		•					•
37	 <p>CHECK DAM</p>	<p>Can be constructed across ditches or any area of concentrated flow. Protects vegetation in early stages of growth. A Check Dam is intended to reduce water velocities and capture sediment. A Check Dam is not a filtering device.</p>	•		•			•	

MICHIGAN DEPARTMENT OF TRANSPORTATION
BUREAU OF HIGHWAY DEVELOPMENT STANDARD PLAN FOR

**SOIL EROSION & SEDIMENTATION
CONTROL MEASURES**

F.H.W.A. APPROVAL	3-20-2003 PLAN DATE	R-96-D
		SHEET 5 OF 6

NOTES:

THIS STANDARD PLAN WILL SERVE AS A KEY IN THE SELECTION OF THE APPROPRIATE SOIL EROSION AND SEDIMENTATION CONTROL DETAILS. THIS PLAN ALSO PROVIDES THE KEY TO THE NUMBERED EROSION CONTROL ITEMS SPECIFIED ON THE CONSTRUCTION PLANS. REFER TO THE MDOT SOIL EROSION & SEDIMENTATION CONTROL MANUAL, SECTION 7 FOR SPECIFIC DETAILS, CONTRACT ITEMS (PAY ITEMS), AND PAY UNITS.

ACTUAL CONSTRUCTION MAY BE VARIED TO REFLECT MATERIALS USED AND SPECIFIC SITE PROBLEMS, SUBJECT TO APPROVAL OF THE ENGINEER.

COLLECTED SILT AND SEDIMENT SHALL BE REMOVED PERIODICALLY TO MAINTAIN THE EFFECTIVENESS OF THE SEDIMENT TRAP, SEDIMENT BASIN, AND SILT FENCE. AGGREGATES PLACED IN STREAMS SHOULD CONTAIN A MINIMUM OF FINES.

TEMPORARY EROSION AND SEDIMENTATION CONTROL PROVISIONS SHALL BE COORDINATED WITH THE PERMANENT CONTROL MEASURES TO ASSURE EFFECTIVE CONTROL OF WATER POLLUTION DURING CONSTRUCTION OF THE PROJECT.

ALL TEMPORARY/PERMANENT EROSION CONTROL DEVICES SHALL BE REMOVED AFTER VEGETATION ESTABLISHMENT OR AT THE DISCRETION OF THE ENGINEER. CARE SHALL BE TAKEN DURING REMOVAL TO MINIMIZE SILTATION IN NEARBY DRAINAGE COURSES.

MICHIGAN DEPARTMENT OF TRANSPORTATION
BUREAU OF HIGHWAY DEVELOPMENT STANDARD PLAN FOR

**SOIL EROSION & SEDIMENTATION
CONTROL MEASURES**

F.H.W.A. APPROVAL

3-20-2003
PLAN DATE

R-96-D

SHEET
6 OF 6

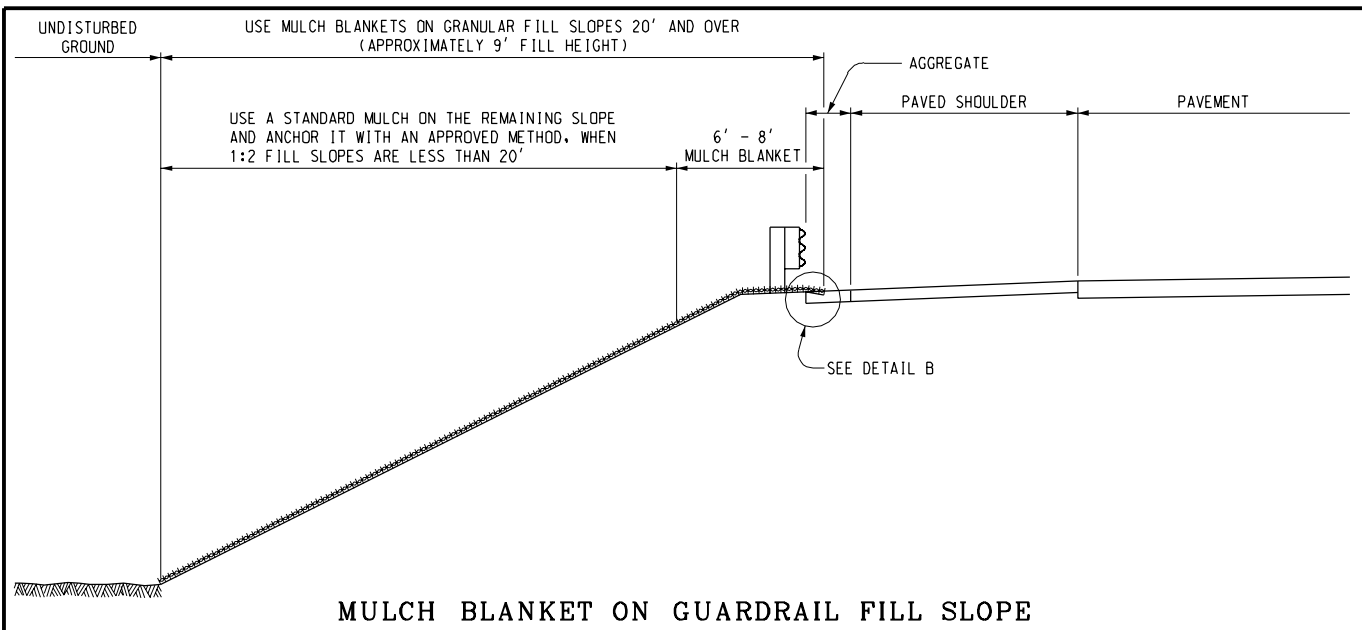

MULCH BLANKET ON GUARDRAIL FILL SLOPE

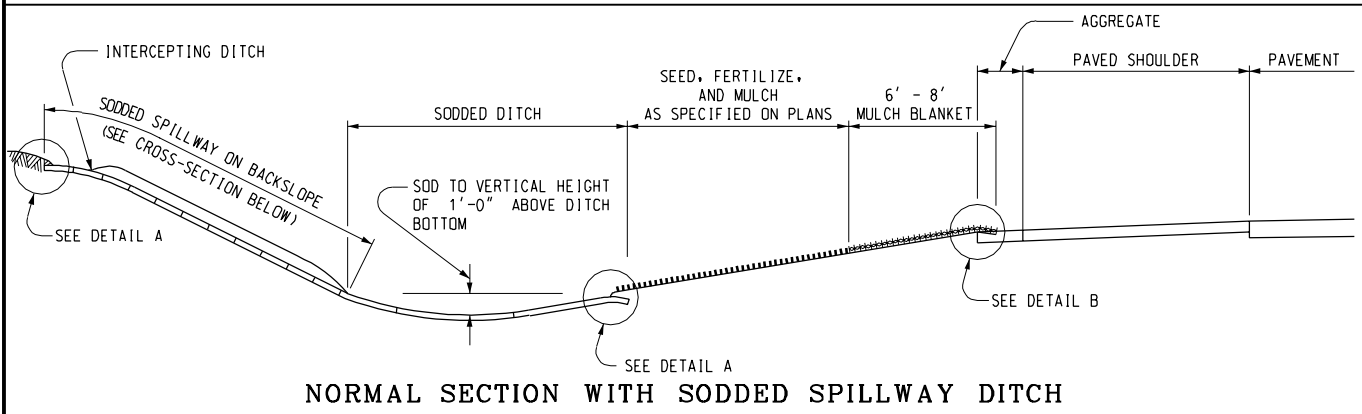

NORMAL SECTION WITH SODDED SPILLWAY DITCH

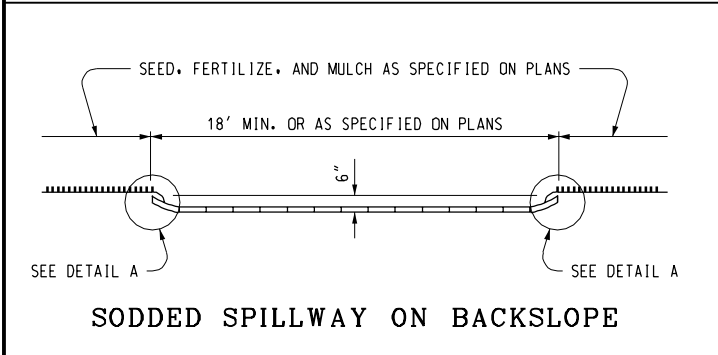

SODDED SPILLWAY ON BACKSLOPE

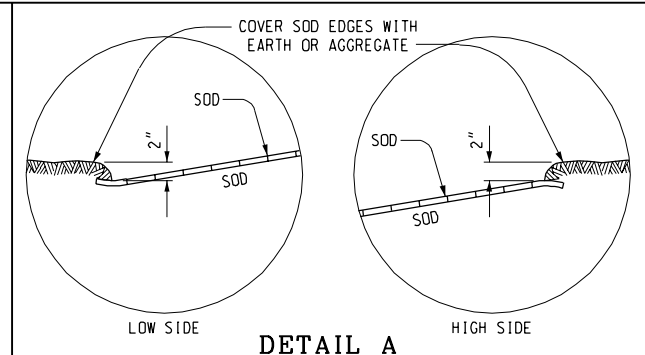

DETAIL A

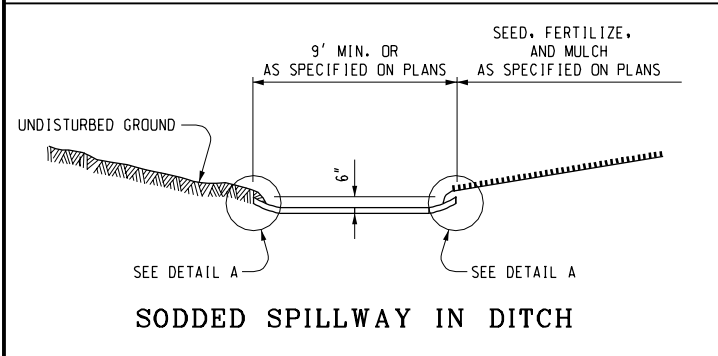

SODDED SPILLWAY IN DITCH

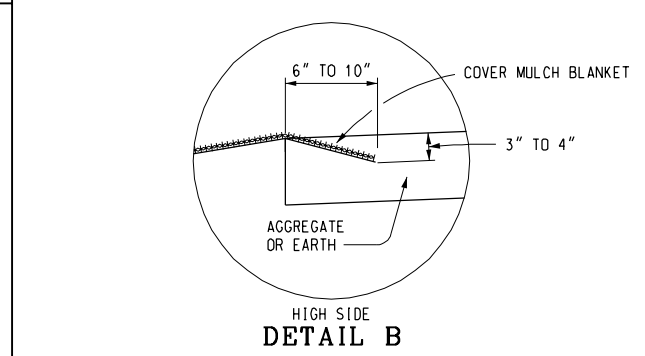

DETAIL B

	ENGINEER OF CONSTRUCTION & TECHNOLOGY	ENGINEER OF DESIGN SUPPORT AREA
	ENGINEER OF MAINTENANCE	DEPARTMENT DIRECTOR Gloria J. Jeff
PREPARED BY DESIGN SUPPORT AREA		ENGINEER OF DEVELOPMENT
DRAWN BY: <u>B.L.T.</u>		
CHECKED BY: <u>W.K.P.</u>	ENGINEER OF TRAFFIC AND SAFETY	

MICHIGAN DEPARTMENT OF TRANSPORTATION BUREAU OF HIGHWAY DEVELOPMENT STANDARD PLAN FOR		
SODDING, SEEDING AND TREE PLANTING		
11-14-2003 F.H.W.A. APPROVAL	7-11-2003 PLAN DATE	R-100-D
		SHEET 1 OF 4

NOTE: THIS PLAN IS NOT A LEGAL ENGINEERING DOCUMENT BUT AN ELECTRONIC DUPLICATE. THE ORIGINAL SIGNED COPY APPROVED FOR PUBLICATION, IS KEPT ON FILE AT THE MICHIGAN DEPARTMENT OF TRANSPORTATION.

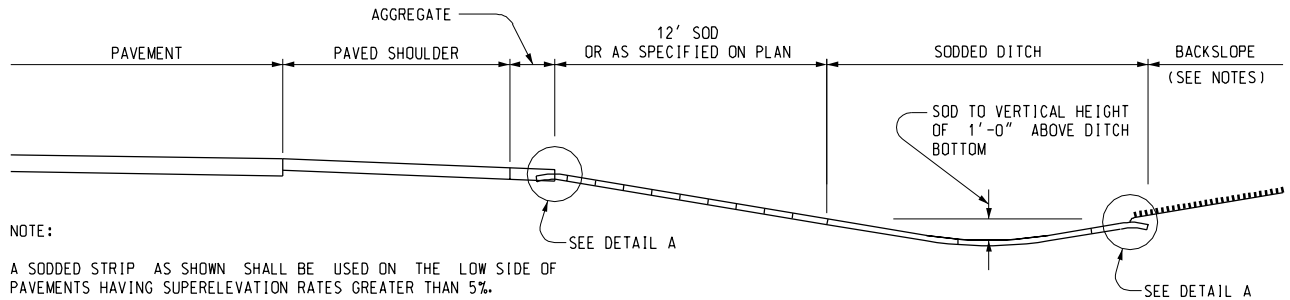
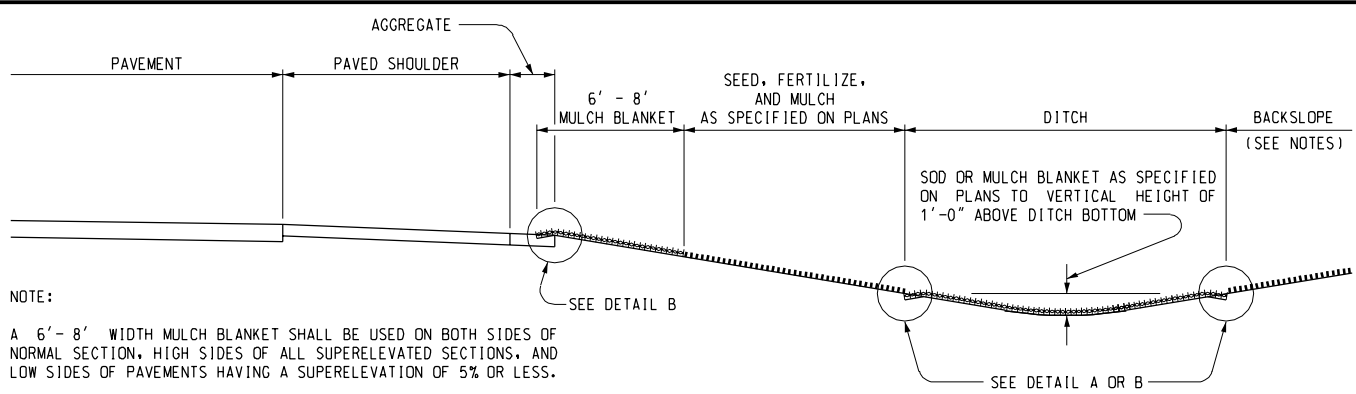

TYPICAL SLOPE AND DITCH PROTECTION

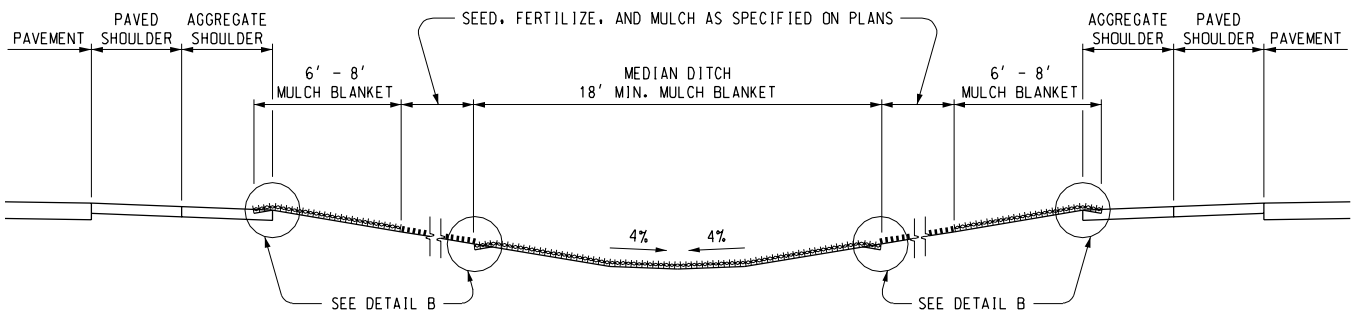

MULCH BLANKET SPILLWAY DITCH

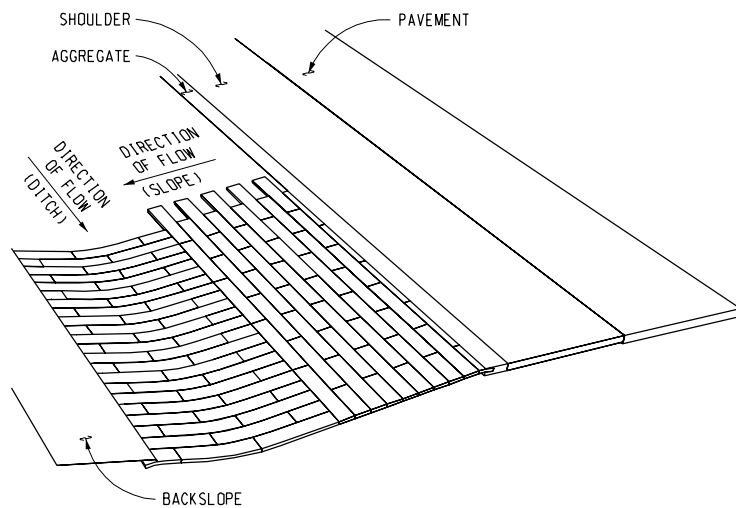

SODDING OF SLOPES & DITCHES

MICHIGAN DEPARTMENT OF TRANSPORTATION
BUREAU OF HIGHWAY DEVELOPMENT STANDARD PLAN FOR

**SODDING, SEEDING
AND TREE PLANTING**

11-14-2003 F.H.W.A. APPROVAL	7-11-2003 PLAN DATE	R-100-D	SHEET 2 OF 4
---------------------------------	------------------------	---------	-----------------

NOTE: THIS PLAN IS NOT A LEGAL ENGINEERING DOCUMENT BUT AN ELECTRONIC DUPLICATE. THE ORIGINAL SIGNED COPY APPROVED FOR PUBLICATION, IS KEPT ON FILE AT THE MICHIGAN DEPARTMENT OF TRANSPORTATION.

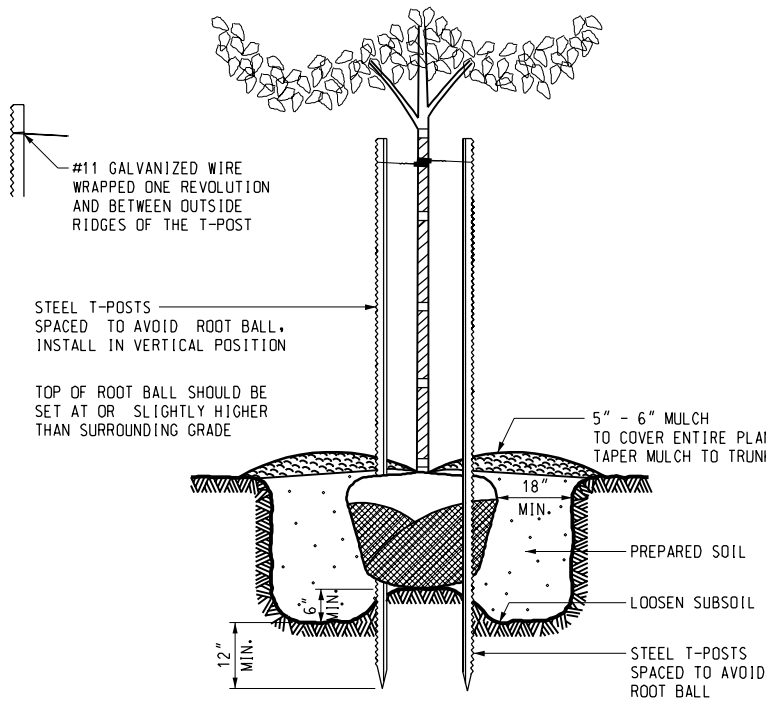

BRACING - VERTICAL STAKES

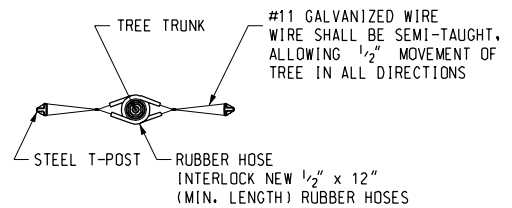

BRACING DETAIL

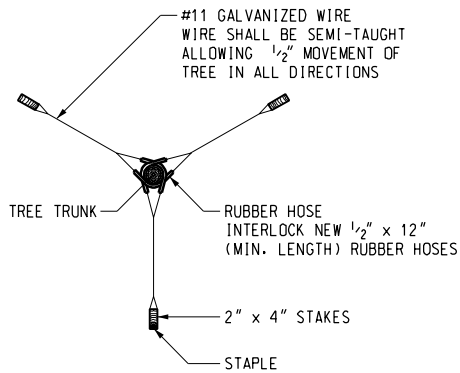

TRIPOD GUYING DETAIL

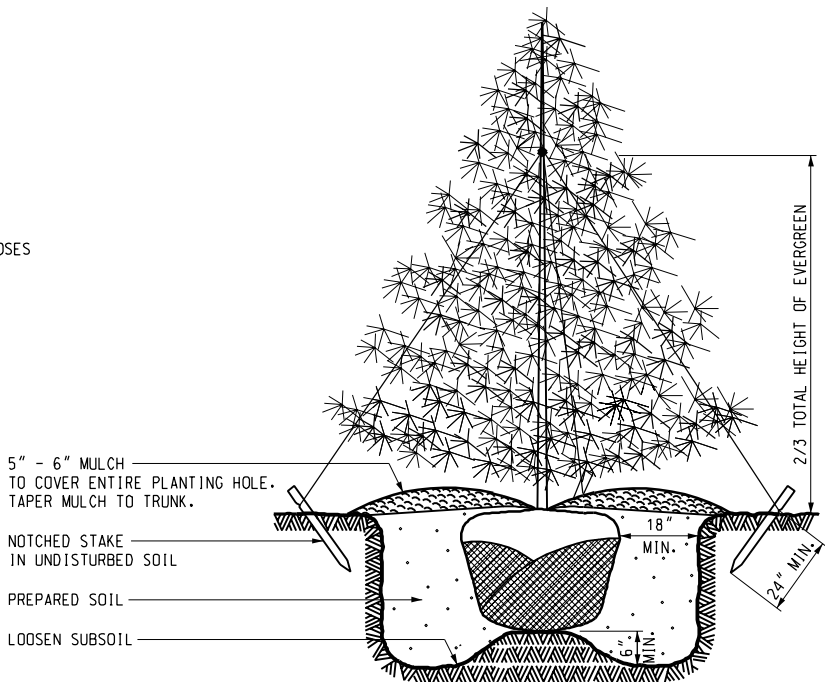

GUYING TRIPOD METHOD

PLANTING NOTES:

LOOSEN SUBSOIL TO A DEPTH OF 4". LOOSEN EARTH ON SIDES OF PLANT POCKET TO BREAK ANY GLAZING CAUSED BY DIGGING.

FILL PREPARED SOIL TO 1/2 THE DEPTH OF THE ROOT BALL. PACK FIRMLY, AND PUDDLE WITH WATER.

BACKFILL WITH PREPARED SOIL WHICH, AFTER COMPACTION, IS FLUSH WITH SURROUNDING GROUND LEVEL.

COVER ENTIRE PLANT POCKET AREA WITH 5"-6" MULCH. PRUNE, WRAP, AND BRACE AND GUY.

MICHIGAN DEPARTMENT OF TRANSPORTATION
BUREAU OF HIGHWAY DEVELOPMENT STANDARD PLAN FOR

**SODDING, SEEDING
AND TREE PLANTING**

11-14-2003
F.H.W.A. APPROVAL

7-11-2003
PLAN DATE

R-100-D

SHEET
3 OF 4

NOTES:

THIS STANDARD ILLUSTRATES THE TYPICAL USE OF SODDING AND/OR SEEDING WITH MULCH, AS THESE ITEMS RELATE TO ROADWAY CONSTRUCTION. THE ACTUAL DESIGN AND MATERIALS USED TO CONSTRUCT THE COMPLETE SECTION, WHICH INCLUDES SODDING AND SEEDING WITH MULCHING, WILL BE ACCORDING TO THE PLANS AND CURRENT SPECIFICATIONS.

ITEMS CALLED FOR ON THIS STANDARD MAY ALSO BE USED DURING CONSTRUCTION AS AN EROSION CONTROL MEASURE. SEE STANDARD PLAN R-96-SERIES.

A SODDED BACKSLOPE IS SIMILAR TO A SODDED FORESLOPE, EXCEPT THE LOWER LIMIT OF SODDING IS AT EDGE OF DITCH.

DITCHES WITH GRADES OF 0.5% TO 4.5% SHOULD HAVE A MINIMUM TREATMENT OF A MULCH BLANKET FOR EROSION CONTROL. SOD SHOULD BE USED IF THERE IS ANY DOUBT THAT THE MULCH BLANKET MIGHT NOT BE ADEQUATE OR IF THE ACCUMULATED DITCH RUNOFF IS LARGE, ESPECIALLY NEAR THE OUTLETS.

THE FIRST 6' BEHIND THE CURB OR SHOULDER IN URBAN MEDIAN AREAS WILL BE SEEDED, FERTILIZED, AND MULCHED WITH MULCH BLANKET. THE REMAINING AREAS WILL BE SEEDED, FERTILIZED, AND MULCHED WITH MULCH BLANKET OR STANDARD MULCH ANCHORED IN PLACE WITH A MULCH ADHESIVE OR WITH A MULCH NET.

ALL AREAS WHERE MULCH BLANKET IS CALLED FOR SHALL BE SEEDED, FERTILIZED, AND TOPSOILED AS SPECIFIED ON PLANS. NO MULCH OR ANCHORING MULCH IS REQUIRED WHERE MULCH BLANKET IS INSTALLED.

TREE HEIGHTS ARE SHOWN BEFORE PRUNING.

TREE PLANTING DEPTHS ARE SHOWN AFTER SETTLING.

MICHIGAN DEPARTMENT OF TRANSPORTATION
BUREAU OF HIGHWAY DEVELOPMENT STANDARD PLAN FOR

SODDING, SEEDING
AND TREE PLANTING

11-14-2003
F.H.W.A. APPROVAL

7-11-2003
PLAN DATE

R-100-D

SHEET
4 OF 4

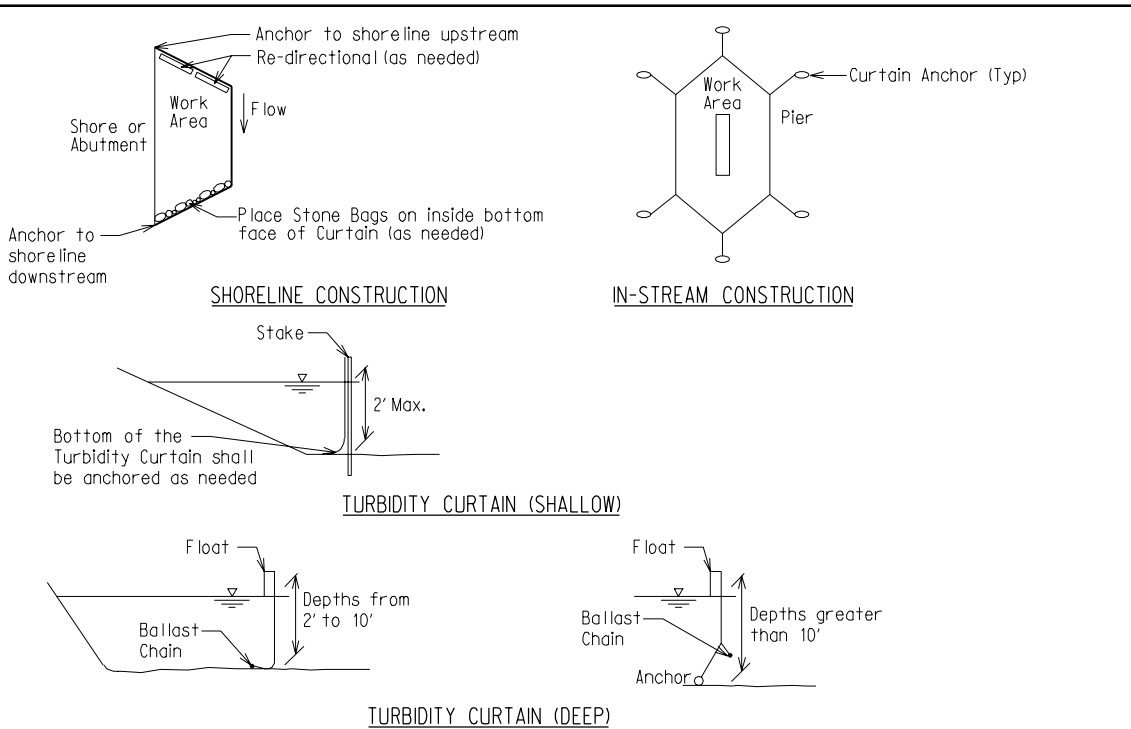

Use:
 A Turbidity Curtain is used when slack water area is necessary to isolate construction activities from the watercourse.

The Turbidity Curtain system shall be designed to handle site specific drainage or flow patterns.
 When water is less than 2 feet deep and has low flow, Turbidity Curtain (Shallow) may be used. Curtain shall be securely fastened to stakes. Water greater than 2 feet deep or where high flow exists requires the use of Turbidity Curtain (Deep).

Installation and Maintenance:
 The Turbidity Curtain shall be installed at the location shown on the plans and according to the special provision.
 The Turbidity Curtain shall be placed parallel to the direction of flow and anchored upstream, downstream, and to the stream bed to maximize protection to the watercourse.

The Contractor shall maintain the Turbidity Curtain until the construction activity within the watercourse is complete or as approved by the Engineer. Retained sediment shall be removed to the maximum extent practicable prior to removing the curtain.

Optional Measures:
 The Turbidity Curtain may include a re-directional barrier on the upstream end of the work area.

Related SESC Measures:
 E & S-18 Dewatering with Filter Bag
 E & S-24 Sand and Stone Bags
 E & S-34 Cofferdam

Measurement and Payment:
 Turbidity Curtain requires inclusion of the appropriate special provision in the contract documents. Payment includes furnishing and installing sufficient anchors, tie-downs, or other mechanisms to ensure proper position and performance of the Turbidity Curtain. Optional work shown, when installed and maintained as directed by the Engineer, will be paid using the associated contract item listed here.

Contract Item (Pay Item)	Pay Unit
Turbidity Curtain (Shallow)	Foot
Turbidity Curtain (Deep)	Foot

MICHIGAN DEPARTMENT OF TRANSPORTATION
 BUREAU OF HIGHWAY DEVELOPMENT SESC DETAIL FOR

Turbidity Curtain

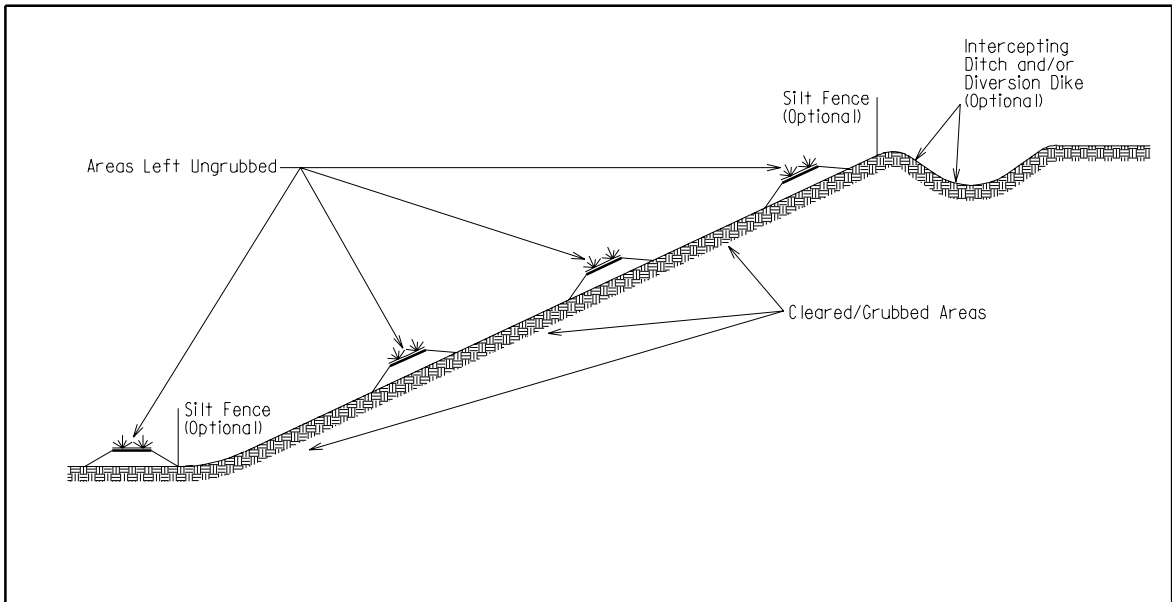

Use:

When long, steep slopes are proposed to be cleared and grubbed, it is a good soil erosion control practice to leave strips of ungrubbed slopes running perpendicular to the flow of water. This practice will reduce sheet flow velocities and prevent rilling and gullying. This practice works well on all slopes regardless of length.

This practice is similar to Vegetative Buffer Strips (E & S-6) since it leaves a portion of the natural vegetation in place to protect and assist in stabilizing the slope.

This practice is not effective in areas of concentrated flows.

Installation and Maintenance:

The strips of natural vegetation to be left undisturbed should be approximately 20 feet wide and spaced approximately 50 feet apart. The spacing of the strips of natural vegetation may be closer than 50 feet on steep slopes.

Optional Measures:

This grading practice may incorporate the use of Silt Fence (E & S-26) for added protection to off-site areas.

A Diversion Dike (E & S-10), Intercepting Ditch (E & S-11), and Intercepting Ditch and Diversion Dike (E & S-12) may be placed at the top of the slope to prevent water from running over the graded area.

Related SESC Measures:

- E & S-6 Vegetative Buffer Strips
- E & S-10 Diversion Dike
- E & S-11 Intercepting Ditch
- E & S-12 Intercepting Ditch and Diversion Dike
- E & S-26 Silt Fence

Measurement and Payment:

There is no separate contract item for this E & S measure. Payment for Grubbing Omitted will be included in related items of work. Optional work shown, when installed and maintained as directed by the engineer, will be paid using the associated contract item listed here.

Contract Item (Pay Item)	Pay Unit
Ditch, Intercepting	Station
Embankment, LM	Cubic Yard
Erosion Control, Silt Fence	Foot

MICHIGAN DEPARTMENT OF TRANSPORTATION BUREAU OF HIGHWAY DEVELOPMENT SESC DETAIL FOR			
Grubbing Omitted			
	04-07-2006 PLAN DATE	E&S-2-A	SHEET 1 OF 1

Use:

Permanent/Temporary Seeding of grasses and legumes is the most common and economical means of establishing protective cover. The advantages of seeding over other means of establishing vegetation includes low initial cost, a wide variety of available grasses and legumes, lower labor input and ease of application.

Permanent/Temporary Seeding controls erosion by physically protecting bare soil from raindrop impact, flowing water and wind. Vegetation binds soil particles together with a dense root system and reduces the velocity and volume of overland flow. Wherever site conditions permit, this is the preferred method of surface stabilization.

Problems to consider are: the potential for erosion during the establishment period, the need to reseed areas, seasonal limitations on seeding, weed competition, and the need for water during germination and early growth.

Installation and Maintenance:

Permanent/Temporary seedbed preparation, seeding mixtures, rate of application for seed, fertilizer, mulch and water, as well as seeding limitations, shall be in accordance with the Michigan Department of Transportation Standard Specifications for Construction Section 816 Turf Establishment and the Standard Plans, R-100 Series.

Optional Measures:

Temporary seeding shall only be done with the approval of the Engineer.

Related SESC Measures:

- E & S-28 Mulching & Mulch Anchoring
- E & S-32 Surface Roughening & Scarification
- E & S-33 Mulch Blankets and High Velocity Mulch Blankets

Measurement and Payment:

Optional measures, when installed and maintained as directed by the Engineer, will be paid using the associated pay items listed here.

<u>Contract Item (Pay Item)</u>	<u>Pay Unit</u>
Seeding, Mixture --*	Pound
Water, Sodding/Seeding	Unit

* Note: Seeding Mixture may be modified by Special Provision.

MICHIGAN DEPARTMENT OF TRANSPORTATION
BUREAU OF HIGHWAY DEVELOPMENT SESC DETAIL FOR

Permanent/Temporary Seeding



09-30-2005
PLAN DATE

E&S-3-A

SHEET
1 OF 1

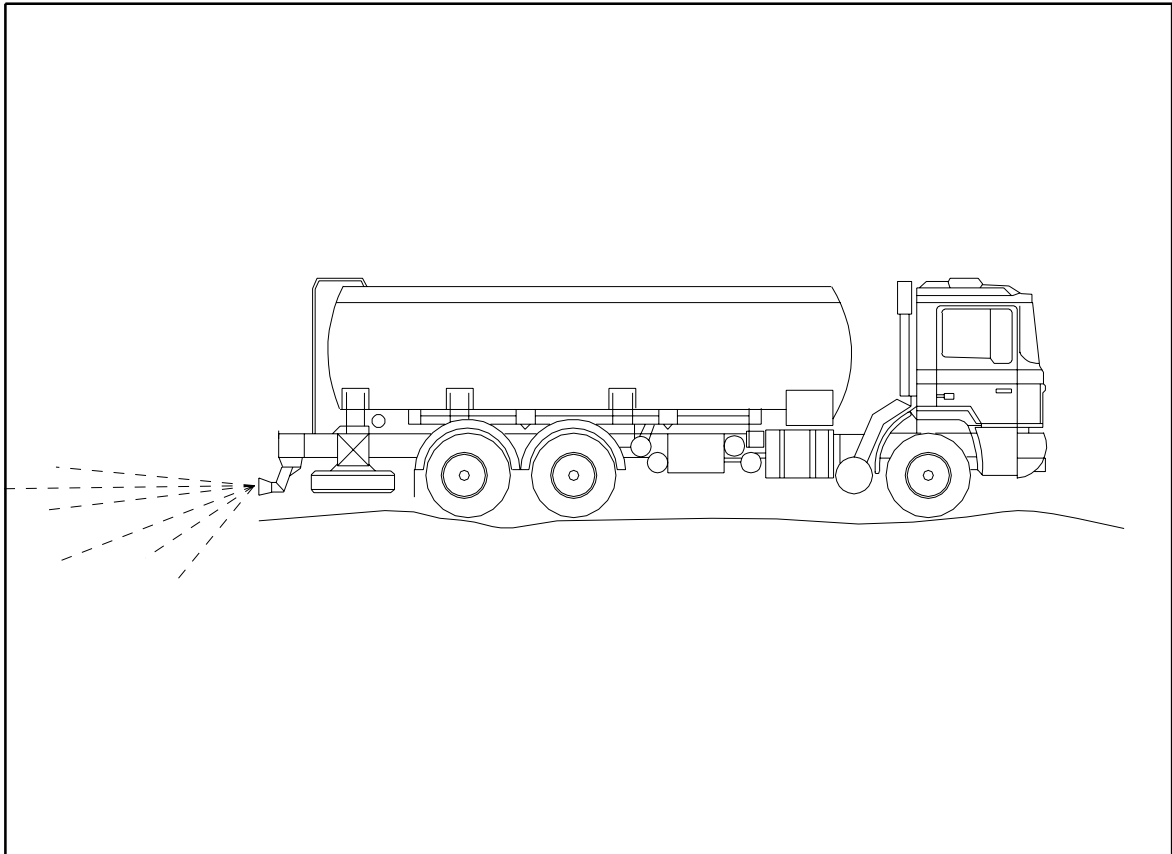

Use:

For disturbed areas not subject to traffic, vegetation (temporary or permanent) provides the most practical and effective means of Dust Control. For other areas, Dust Control measures include, but are not limited to, mulching, sweeping, watering, and applying calcium chloride or polymers.

Installation and Maintenance:

For off-road areas where vegetation will be the final stabilization method, calcium chloride shall not be used since it would inhibit vegetation establishment.

Optional Measures:

Related SESC Measures:

- E & S-3 Permanent/Temporary Seeding
- E & S-8 Aggregate Cover
- E & S-14 Gravel Access Approach
- E & S-28 Mulching and Mulch Anchoring
- E & S-32 Surface Roughening and Scarification
- E & S-33 Mulch Blankets and High Velocity Mulch Blankets

Measurement and Payment:

If not shown as a pay item, payment for Dust Control will be included in related items of work.

<u>Contract Item (Pay Item)</u>	<u>Pay Unit</u>
Dust Palliative, Applied	Ton

MICHIGAN DEPARTMENT OF TRANSPORTATION
BUREAU OF HIGHWAY DEVELOPMENT SESC DETAIL FOR

Dust Control



04-07-2006
PLAN DATE

E&S-4-A

SHEET
1 OF 1

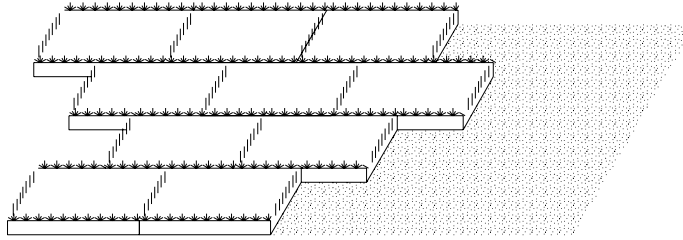

Lay sod in a staggered pattern with strips butted tightly against each other. A sharpened mason's trowel can be used to tuck down the ends and trim pieces.

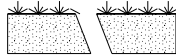

Correct

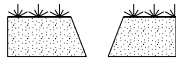

Incorrect

Angled Ends must be matched correctly.

Use:

Sodding provides an immediate vegetative cover for spillways and ditches.

Installation and Maintenance:

Due to high maintenance and difficult roadside establishment conditions, Sodding should only be used in areas where Permanent/Temporary Seeding (E & S-3) or Mulch Blankets (E & S-33) will not work. Since Sod requires frequent watering for its survival, it is not a good substitute for seeding.

Optional Measures:

In areas of concentrated ditch flow, seed and High Velocity Mulch Blankets (E & S-33) may be used.

See subsection 816.03 of the Standard Specifications for details and limitations for sodding.

Related SESC Measures:

E & S-33 Mulch Blankets and High Velocity Mulch Blankets

Measurement and Payment:

Contract Item (Pay Item)	Pay Unit
Sodding	Square Yard
Water, Sodding/Seeding	Unit

MICHIGAN DEPARTMENT OF TRANSPORTATION
BUREAU OF HIGHWAY DEVELOPMENT SESC DETAIL FOR

Sodding



04-07-2006
PLAN DATE

E&S-5-A

SHEET
1 OF 1

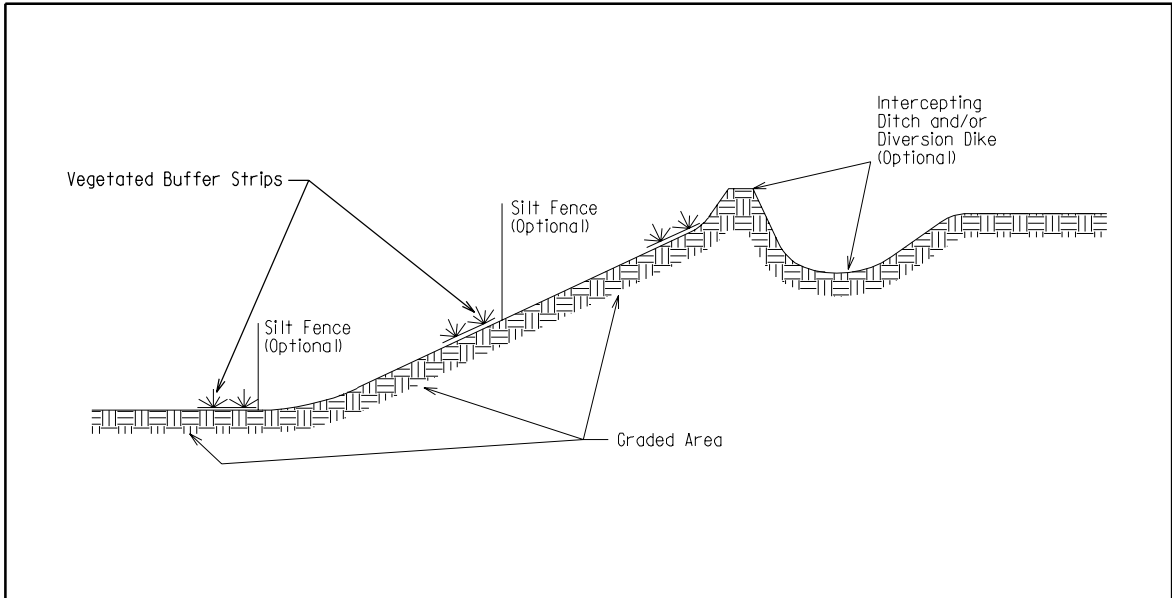

Use:

When slopes are proposed to be graded, it is a good practice to leave Vegetated Buffer Strips or undisturbed areas running perpendicular to the flow of water. This practice will reduce sheet flow velocities and prevent rilling and gullyling.

Vegetated Buffer Strips will also assist in the establishment of a permanent vegetative cover, preventing slope sloughing and loss of seed and mulch. Vegetative Buffer Strips also provide wind breaks, reducing the potential for wind erosion.

This practice is similar to Grubbing Omitted (E & S-2) since it leaves a portion of the natural vegetation in place to protect and assist in stabilizing the slope.

This practice is not effective in areas of concentrated flows.

Installation and Maintenance:

The strips of natural vegetation to be left undisturbed should be approximately 20 feet wide and spaced approximately 50 feet apart. The spacing of the strips of natural vegetation may be closer than 50 feet on steep slopes.

Optional Measures:

For added protection to off-site areas, this grading practice may include the use of Silt Fence (E & S-26).

A Diversion Dike (E & S-10), Intercepting Ditch (E & S-11), and Intercepting Ditch and Diversion Dike (E & S-12) may be placed at the top of the slope to prevent water from running over the graded area.

Related SESC Measures:

- E & S-2 Grubbing Omitted
- E & S-10 Diversion Dike
- E & S-11 Intercepting Ditch
- E & S-12 Intercepting Ditch and Diversion Dike
- E & S-26 Silt Fence

Measurement and Payment:

There is no separate contract item for this E & S measure. Payment for Vegetated Buffer Strips will be included in related items of work. Optional work shown, when installed and maintained as directed by the Engineer, will be paid using the associated contract item listed here.

<u>Contract Item (Pay Item)</u>	<u>Pay Unit</u>
Ditch, Intercepting	Station
Erosion Control, Silt Fence	Foot
Embankment, LM	Cubic Yard
Embankment, CIP	Cubic Yard

MICHIGAN DEPARTMENT OF TRANSPORTATION BUREAU OF HIGHWAY DEVELOPMENT SESC DETAIL FOR			
<h2 style="margin: 0;">Vegetated Buffer Strips</h2>			
	04-07-2006 PLAN DATE	E&S-6-A	SHEET 1 OF 1

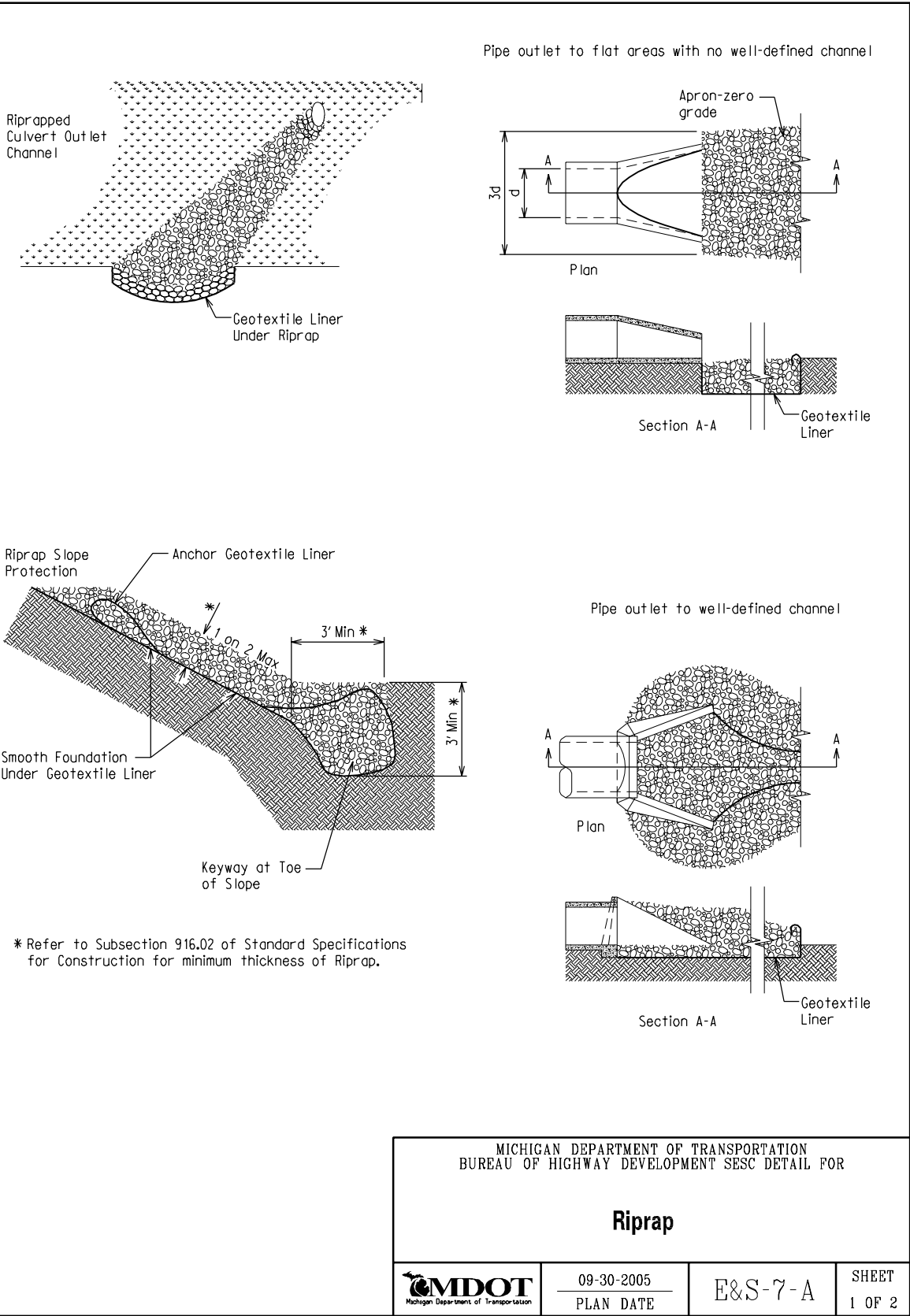

Pipe outlet to flat areas with no well-defined channel

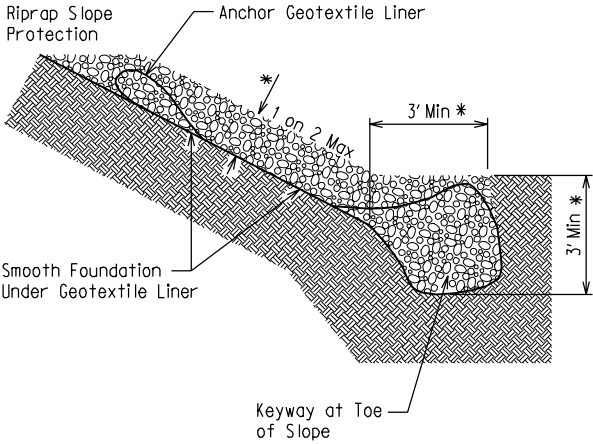
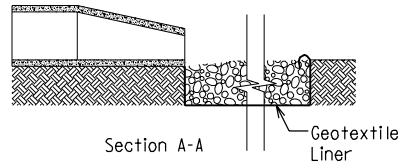
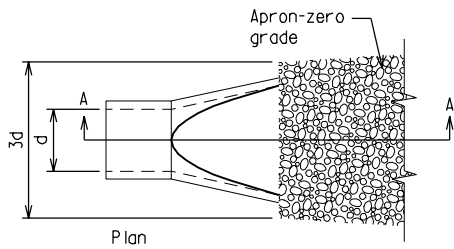
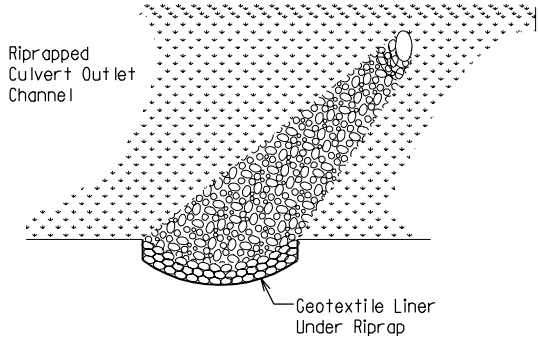

Pipe outlet to well-defined channel

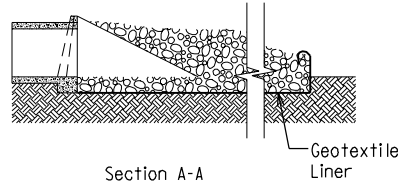
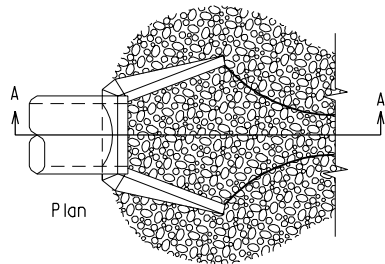

* Refer to Subsection 916.02 of Standard Specifications for Construction for minimum thickness of Riprap.

MICHIGAN DEPARTMENT OF TRANSPORTATION
BUREAU OF HIGHWAY DEVELOPMENT SESC DETAIL FOR

Riprap



09-30-2005
PLAN DATE

E&S-7-A

SHEET
1 OF 2

Use:

Riprap should be sized to ensure that the size of stone is adequate to protect the area from erosion and subsequent siltation to off-site locations. Refer to Chapter 9 of the Drainage Manual for additional information on specifying Riprap.

Riprap provides an immediate and effective, non-erodible cover over raw erodible areas. A properly designed layer of stone can be used to control erosion. Riprap protects the soil surface from direct erosive forces such as wind, rain and surface runoff. It is often used on steep slopes subject to weathering or seepage, for channel liners, inlet and outlet protection at culverts, streambank protection and to protect shorelines subjected to wave action.

Clean, well-graded Riprap forms a dense, flexible, self-healing cover that will adapt well to uneven surfaces. Care must be exercised in the design and installation process so that the Riprap is clean, free of visible rebar, sized correctly and placed to the proper thickness.

Riprap placed at culvert outlets can be used to protect the stream bed and channel, thus reducing the flow velocity to a level that is non-erosive.

Riprap is used at the outlet of storm drains and as channel linings when flow velocities and concentrations are high and/or the channel slope is steep. Riprap is effective on the banks of channels, at changes in flow direction and to stabilize erodible slopes.

Installation and Maintenance:

Riprap shall be placed on Geotextile Liner to prevent soil 'piping' from seepage or runoff. The edges of the Geotextile Liner shall be overlapped a minimum of 2 feet. Place Riprap immediately after installing Geotextile Liner.

When Riprap, Heavy is specified, Geotextile Liner, Heavy must be used.

Refer to Subsection 813.03.E of the Standard Specifications for Construction for additional installation details.

Care must be taken to properly secure edges of Geotextile Liner to prevent piping.

When Riprap is placed as a permanent erosion control measure, the top of Riprap should be approximately level with surrounding soil surface.

Do not mix erodible soil with Riprap during placement.

Optional Measures:

Related SESC Measures:

S & E-19 Energy Dissipators

Measurement and Payment:

<u>Contract Item (Pay Item)</u>	<u>Pay Unit</u>
Riprap, Heavy	Square Yard
Riprap, Heavy, LM	Cubic Yard
Riprap, Plain	Square Yard
Riprap, Plain LM	Cubic Yard
Grouted Riprap	Square Yard

Note: Gradations and dimensions of Riprap may be modified by Special Provision.

PERMITS FROM THE MICHIGAN DEPARTMENT OF ENVIRONMENTAL QUALITY MAY BE REQUIRED.

MICHIGAN DEPARTMENT OF TRANSPORTATION
BUREAU OF HIGHWAY DEVELOPMENT SESC DETAIL FOR

Riprap



04-07-2006
PLAN DATE

E&S-7-A

SHEET
2 OF 2

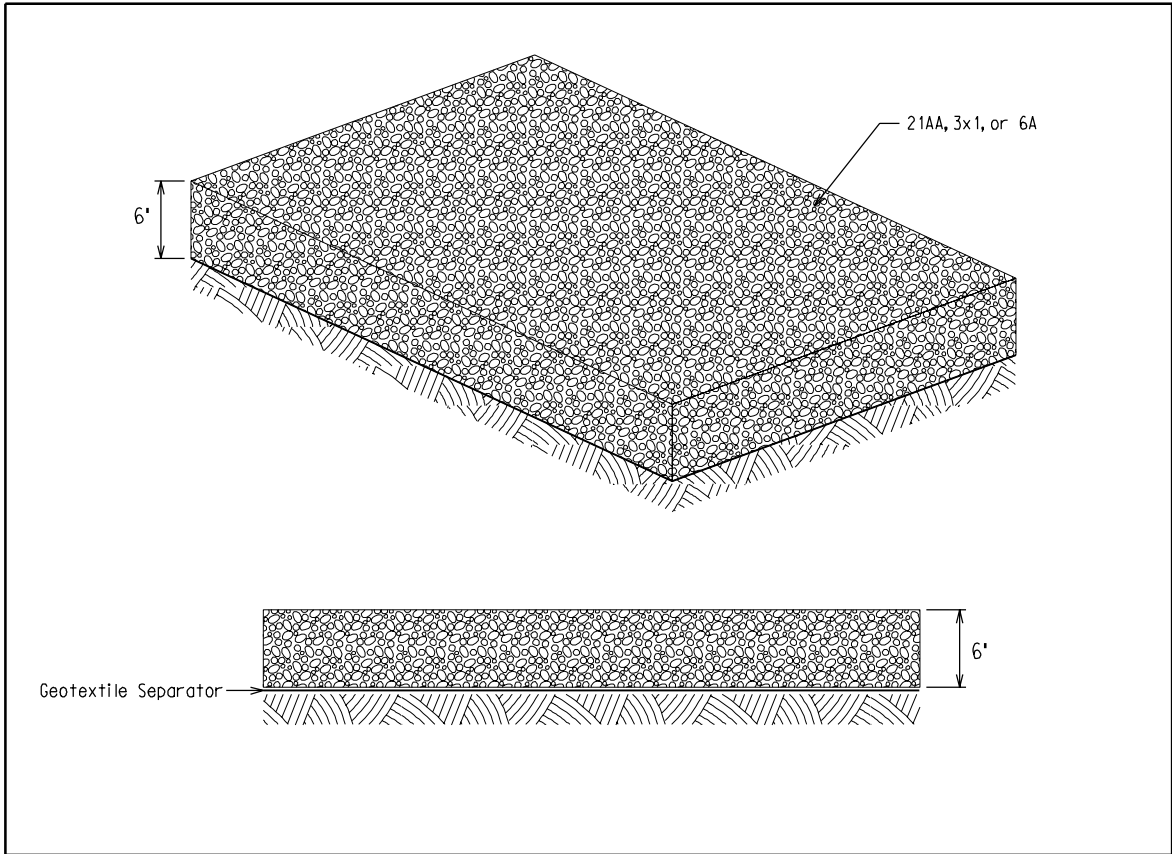

Use:

Temporary Aggregate Cover can be used anywhere on a construction site where a stable area is desired for construction operations, equipment storage, heavy traffic use, or any areas which could develop into a soil erosion problem, as a result of intensive activities and loss of vegetative cover.

Aggregate Cover may be used in conjunction with Gravel Access Approach (E & S-14).

Installation and Maintenance:

Replace or replenish aggregate cover during construction if it is no longer preventing soil erosion.

Optional Measures:

Related SESC Measures:

E & S-14 Gravel Access Approach

Measurement and Payment:

<u>Contract Item (Pay Item)</u>	<u>Pay Unit</u>
Erosion Control, Aggregate Cover	Square Yard
Erosion Control, Gravel Access Approach	Each

MICHIGAN DEPARTMENT OF TRANSPORTATION BUREAU OF HIGHWAY DEVELOPMENT SESC DETAIL FOR			
Aggregate Cover			
 Michigan Department of Transportation	04-07-2006 PLAN DATE	E&S-8-A	SHEET 1 OF 1

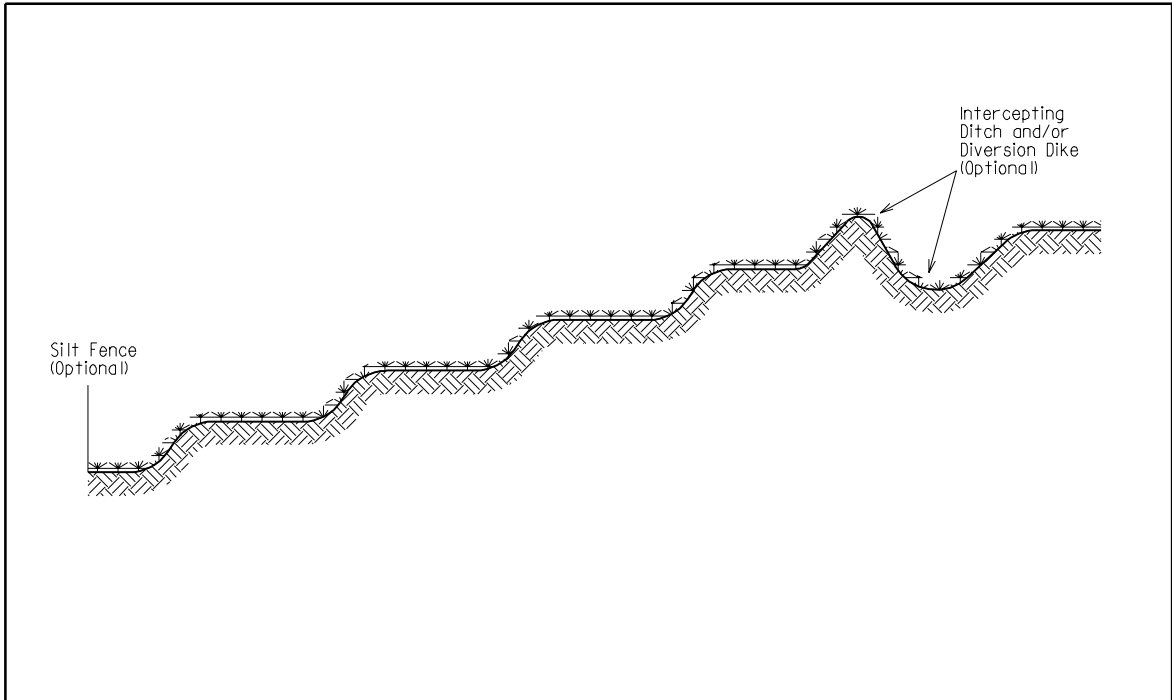

Use:

Benches are generally placed on long slopes to reduce runoff velocity by reducing the effective slope length. Benches prevent sheet flow from gaining velocity and developing concentrated flows, preventing rilling and gullyng.

Installation and Maintenance:

Bench dimensions to be determined by the engineer in field to maximize effectiveness.

If sediment is being transported by sheet flow coming down the slopes, it will be deposited on the benched area and not transported to the toe of slope or off-site. Sediment can then be removed or stabilized in place by the use of seed, fertilizer and mulch.

Optional Measures:

A Diversion Dike (E & S-10), Intercepting Ditch (E & S-11), and Intercepting Ditch and Diversion Dike (E & S-12) may be used at the top of slopes to minimize flow over the benched areas.

A Silt Fence (E & S-26) may be installed at the toe of slope for added protection to off-site areas.

Related SESC Measures:

- E & S-3 Permanent/Temporary Seeding
- E & S-10 Diversion Dike
- E & S-11 Intercepting Ditch
- E & S-12 Intercepting Ditch and Diversion Dike
- E & S-26 Silt Fence

Measurement and Payment:

There is no separate contract item for this E & S measure. Payment for Benches will be included in related items of work. Optional work shown, when installed and maintained as directed by the Engineer, will be paid using the associated contract item listed here.

<u>Contract Item (Pay Item)</u>	<u>Pay Unit</u>
Ditch, Intercepting	Station
Erosion Control, Silt Fence	Foot
Embankment, LM	Cubic Yard
Embankment, CIP	Cubic Yard

MICHIGAN DEPARTMENT OF TRANSPORTATION BUREAU OF HIGHWAY DEVELOPMENT SESC DETAIL FOR			
<h2 style="margin: 0;">Benches</h2>			
	04-07-2006 PLAN DATE	E&S-9-A	SHEET 1 OF 1

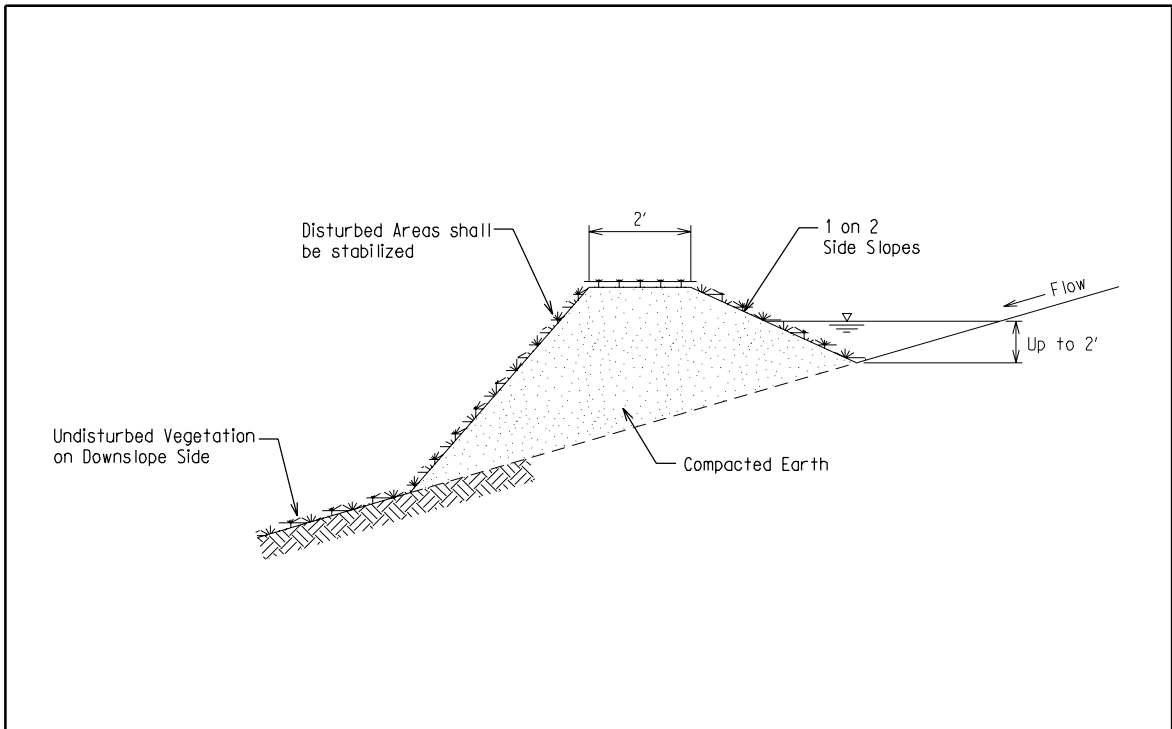

Use:

Refer to the Drainage Manual for additional design considerations when specifying this device.

A Diversion Dike is a temporary or permanent ridge of compacted earth constructed across sloping land, on a predetermined grade, to protect work areas or sensitive areas from upslope runoff by diverting flow away from the site to an appropriate outlet. The Diversion Dike shall be stabilized.

Installation and Maintenance:

This practice is best utilized in construction areas where runoff can be diverted and properly outletted to control erosion, sedimentation or flood damage. Specific locations and conditions may include:

- Above disturbed slopes to prevent runoffs over the slope;
- Across unprotected slopes or at slope breaks to reduce slope length;
- Below slopes to divert excess runoff to stabilized outlets;
- Diversion of sediment-laden water to sediment traps;
- At or near the perimeter of the construction area to keep sediment from leaving the site;

Optional Measures:

Related SESC Measures:

- E & S-11 Intercepting Ditch
- E & S-12 Intercepting Ditch and Diversion Dike
- E & S-13 Gravel Filter Berm
- E & S-15 Slope Drain Surface
- E & S-20 Sediment Trap
- E & S-37 Check Dam

Measurement and Payment:

There is no separate contract item for this E & S measure. Payment for Diversion Dike will be included in related items of work. Optional work shown, when installed and maintained as directed by the Engineer, will be paid using the associated contract items listed here.

Contract Item (Pay Item)	Pay Unit
Embankment, LM	Cubic Yard
Embankment, CP	Cubic Yard

MICHIGAN DEPARTMENT OF TRANSPORTATION BUREAU OF HIGHWAY DEVELOPMENT SESC DETAIL FOR			
Diversion Dike			
	04-07-2006 PLAN DATE	E&S-10-A	SHEET 1 OF 1

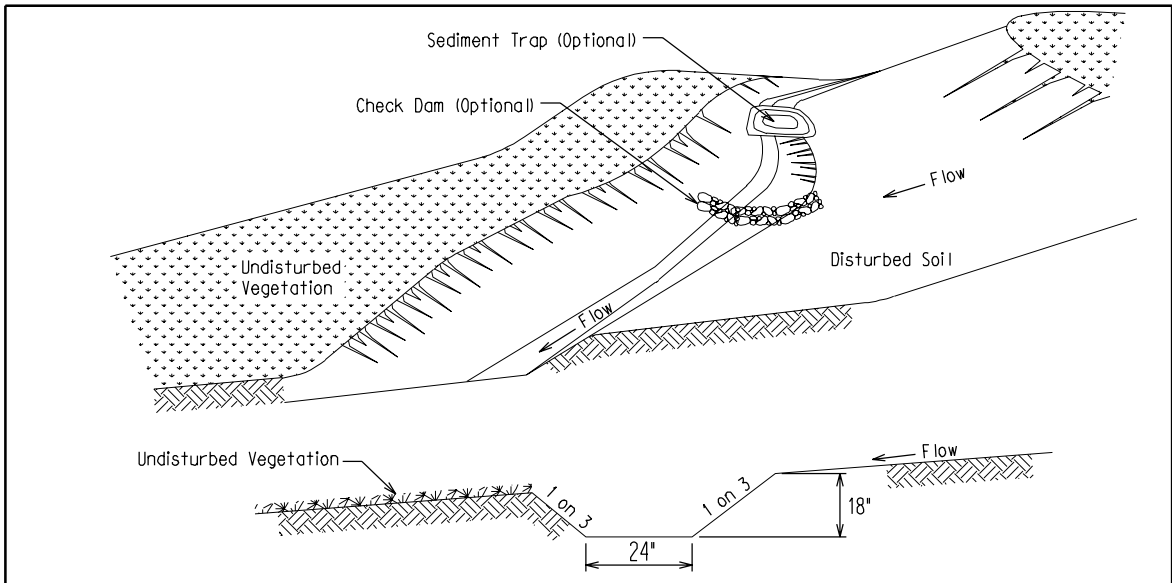

Use:

Refer to the Drainage Manual for additional design considerations when specifying this device.

An Intercepting Ditch is a long, narrow ditch excavated into the earth on the upslope or downslope side of a drainage area. It is used to intercept storm runoff and divert it to a safe outlet location where sediment can be removed by reducing water velocity.

Installation and Maintenance:

This practice is best utilized in construction areas where runoff can be diverted to control erosion, sedimentation or flood damage. Specific locations and conditions may include:

- Above disturbed slopes to prevent runoff over the slope;
- Across unprotected slopes or at slope breaks to reduce the slope length;
- Below slopes to divert excess runoff to stabilized outlets;
- Diversion of sediment-laden water to sediment traps;
- At or near the perimeter of the construction area to keep sediment from leaving the site;

If the Intercepting Ditch (E & S-11) is used as a temporary measure on multi-year projects or remains as a permanent device, exposed areas shall be stabilized throughout the limits of the ditch.

Optional Measures:

Check Dam (E & S-37) and Sediment Trap (E & S-20) may be installed at upstream end of ditch. If Ditch is discharging water containing sediments, discharge to Sediment Trap (E & S-20) or Sediment Basin (E & S-21).

Related SESC Measures:

- E & S-3 Permanent/ Temporary Seeding
- E & S-10 Diversion Dike
- E & S-12 Intercepting Ditch and Diversion Dike
- E & S-13 Gravel Filter Berm
- E & S-15 Slope Drain Surface
- E & S-20 Sediment Trap
- E & S-21 Sediment Basin
- E & S-27 Plastic Sheets or Geotextile Cover
- E & S-33 Mulch Blankets and High Velocity Mulch Blankets
- E & S-37 Check Dam

Measurement and Payment:

Optional work shown, when installed and maintained as directed by the Engineer, will be paid using the associated contract item listed here. Stabilizing exposed slopes for permanent application of this measure will be included in project quantities for similar work.

Contract Item (Pay Item)	Pay Unit
Ditch, Intercepting	Station
Erosion Control, Check Dam, Stone	Foot
Erosion Control, Sediment Trap	Each
Erosion Control, Sediment Basin	Each
Erosion Control, Maintenance, Sediment Removal	Cubic Yard

MICHIGAN DEPARTMENT OF TRANSPORTATION BUREAU OF HIGHWAY DEVELOPMENT SESC DETAIL FOR			
Intercepting Ditch			
	04-07-2006 PLAN DATE	E&S-11-A	SHEET 1 OF 1

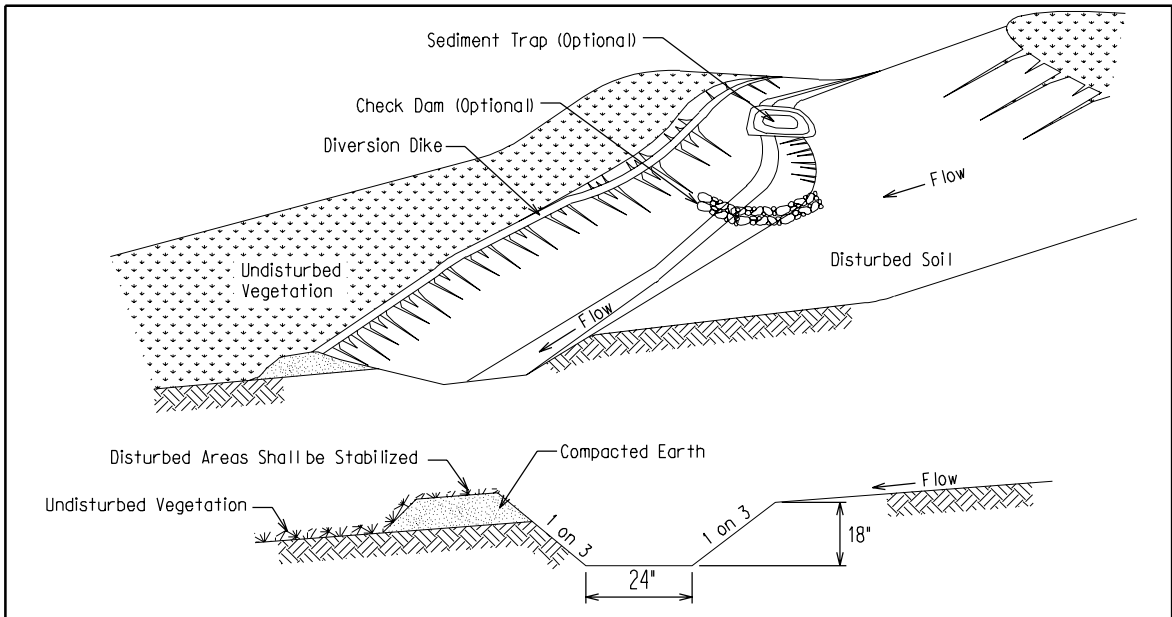

Use:

Refer to the Drainage Manual for additional design considerations when specifying this device.

An Intercepting Ditch and Diversion Dike is used to intercept storm runoff by diverting it to safe outlet areas where sediments can be removed by reducing the water velocity. The ditch is excavated into the earth at the upslope or downslope side of a drainage area. The dike is created and stabilized immediately downslope of the newly created ditch.

Installation and Maintenance:

This measure is best installed in construction areas where Runoff can be diverted to control erosion, sedimentation or flood damage. Specific locations and conditions may include:

- Above disturbed slopes to prevent runoff over the slope;
- Across unprotected slopes or at slope breaks to reduce slope length;
- Below slopes to divert excess runoff to stabilized outlets;
- Diversion of sediment-laden water to sediment traps;
- At or near the perimeter of the construction area to keep sediment from leaving the site;

If the Intercepting Ditch and Diversion Dike is used as a temporary measure on multi-year projects or remains as a permanent device, exposed areas shall be stabilized throughout the limits of the ditch.

If the Engineer determines that excavated soil is suitable, it may be placed and compacted on the downhill side of the ditch to create the dike.

Optional Measures:

Check Dam (E & S-37) and Sediment Trap (E & S-20) may be required at upstream end of ditch. If ditch is discharging water containing sediment, discharge to Sediment Trap (E & S-20) or Sediment Basin (E & S-21).

Related SESC Measures:

- | | |
|-------------------------------------|--|
| E & S-3 Permanent/Temporary Seeding | E & S-20 Sediment Trap |
| E & S-10 Diversion Dike | E & S-33 Mulch Blankets and High Velocity Mulch Blankets |
| E & S-11 Intercepting Ditch | E & S-37 Check Dam |
| E & S-15 Slope Drain Surface | |

Measurement and Payment:

Optional work shown, when installed and maintained as directed by the Engineer, will be paid using the associated contract item listed here. Stabilizing exposed slopes for permanent application of this measure will be included in project quantities for similar work. Additional material and work required to construct the Diversion Dike will be paid as Embankment.

Contract Item (Pay Item)	Pay Unit
Erosion Control, Check Dam, Stone	Foot
Erosion Control, Sediment Trap	Each
Ditch, Intercepting	Station
Embankment, LM	Cubic Yard
Embankment, CP	Cubic Yard

MICHIGAN DEPARTMENT OF TRANSPORTATION
BUREAU OF HIGHWAY DEVELOPMENT SESC DETAIL FOR

Intercepting Ditch and Diversion Dike

MDOT <small>Michigan Department of Transportation</small>	04-07-2006 PLAN DATE	E&S-12-A	SHEET 1 OF 1
---	-------------------------	----------	-----------------

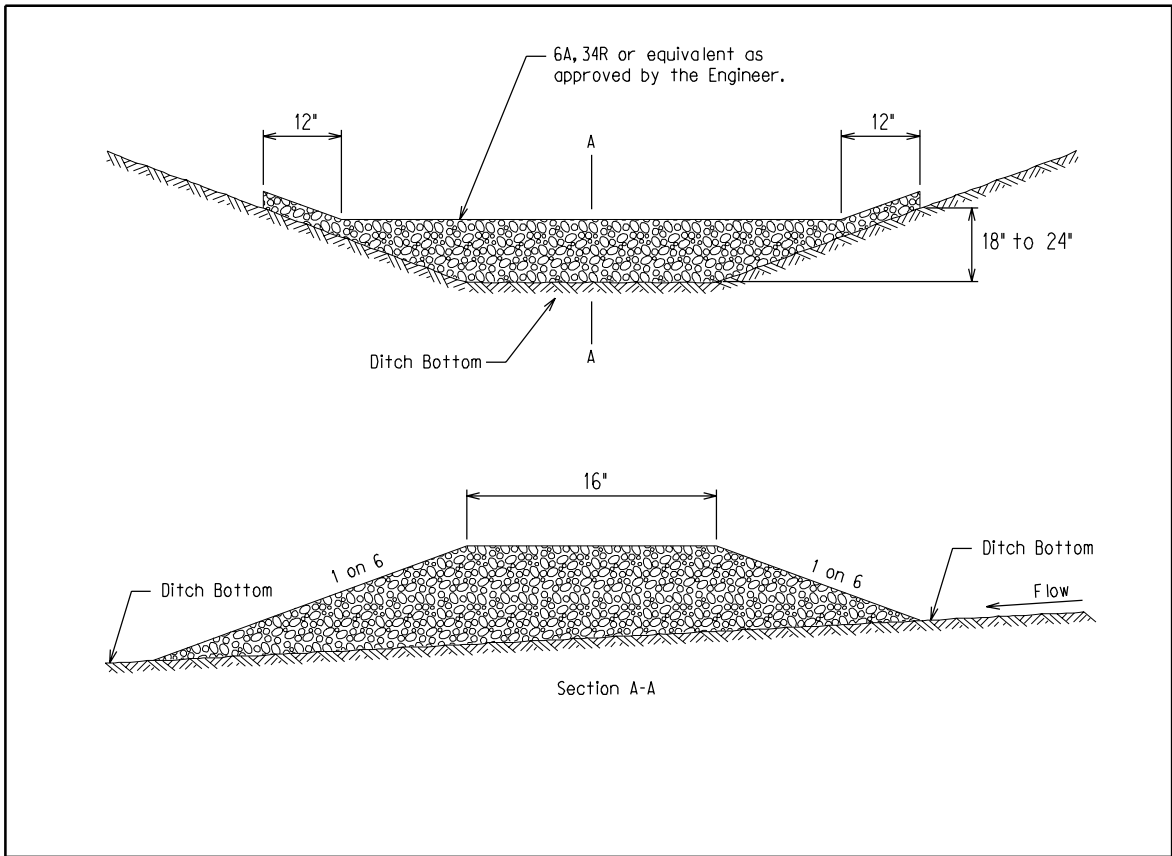

Use:

Refer to the Drainage Manual for additional considerations when specifying this device.

A Gravel Filter Berm is a temporary structure to be placed wherever water flow requires filtering before leaving a construction site.

Gravel Filter Berm shall not be used in lieu of a Check Dam (E & S-37). Check Dams may provide some filtration, but the primary function is to dissipate energy to allow particle settlement.

Installation and Maintenance:

This device may require periodic maintenance to ensure adequate filtration.

Optional Measures:

Larger stone may be used as coarse aggregate to provide stable berm on steep slopes.

Related SESC Measures:

- E & S-18 Dewatering with Filter Bag
- E & S-20 Sediment Trap

Measurement and Payment:

Payment for Gravel Filter Berm includes larger stone use to stabilize berm.

<u>Contract Item (Pay Item)</u>	<u>Pay Unit</u>
Erosion Control, Gravel Filter Berm	Foot

MICHIGAN DEPARTMENT OF TRANSPORTATION
BUREAU OF HIGHWAY DEVELOPMENT SESC DETAIL FOR

Gravel Filter Berm

	04-07-2006 PLAN DATE	E&S-13-A	SHEET 1 OF 1
---	-------------------------	----------	-----------------

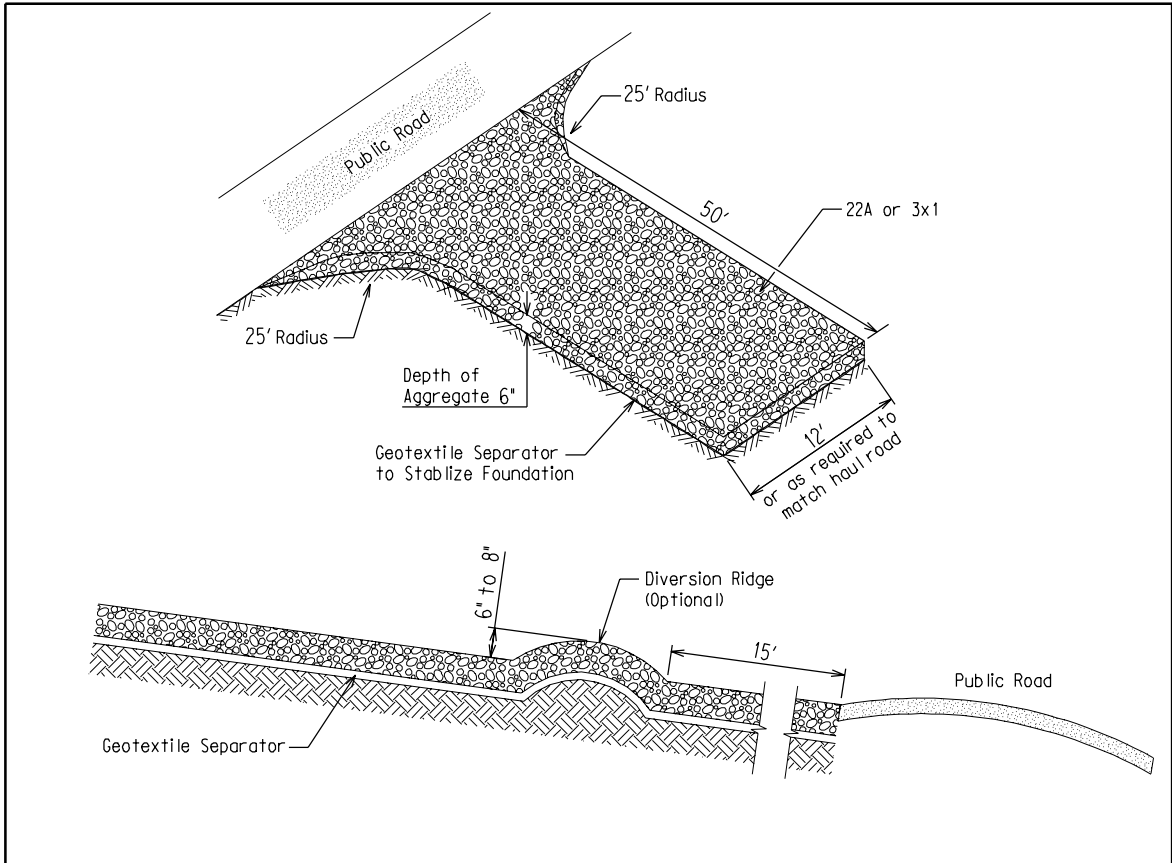

Use:

Providing a stable Gravel Access Approach, minimizes the tracking of loose materials from the construction site onto public roadways. Coarser aggregate is more effective in reducing tracking. Any materials tracked onto public roadways shall be removed as specified in the Standard Specifications for Construction, or as directed by the Engineer.

Installation and maintenance of Gravel Access Approach is effective in reducing sediment loading to inlet protection devices.

Installation and Maintenance:

The Gravel Access Approach should be located in accordance with the plans or as directed by the Engineer. All vegetation and other objectionable material shall be removed from the foundation area. Geotextile Separator must be placed beneath the aggregate to stabilize the foundation.

Replace or replenish aggregate if it is no longer preventing tracking.

Optional Measures:

A Gravel Access with Diversion Ridge is recommended where access grade exceeds 2%. This will also aid in dislodging soil or debris from tires.

Related SESC Measures:

Measurement and Payment:

Optional work shown, when installed and maintained as directed by the Engineer, will be included in the item Gravel Access Approach

Contract Item (Pay Item)	Pay Unit
Erosion Control, Gravel Access Approach	Each

MICHIGAN DEPARTMENT OF TRANSPORTATION
BUREAU OF HIGHWAY DEVELOPMENT SESC DETAIL FOR

Gravel Access Approach



04-07-2006
PLAN DATE

E&S-14-A

SHEET
1 OF 1

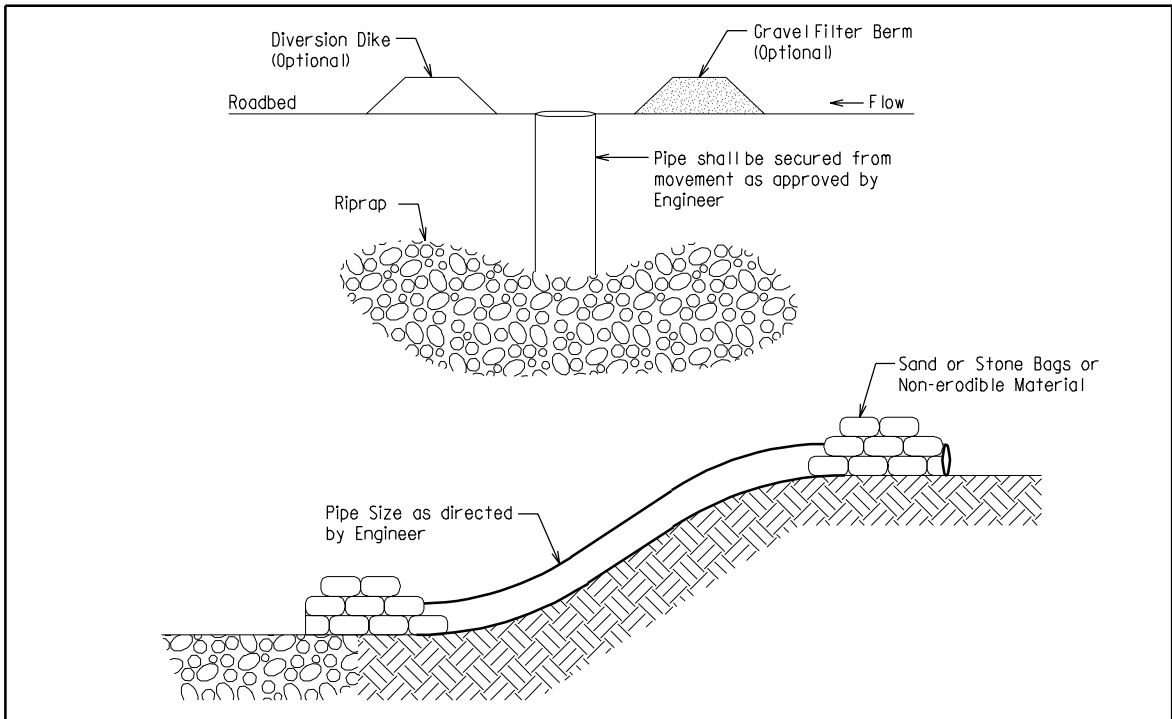

Use:

Refer to the Drainage Manual for additional design considerations when specifying this device.

Slope Drain Surface is a temporary device intended to carry water down slope in a controlled manner, to prevent slope erosion and subsequent sedimentation.

Installation and Maintenance:

The pipe shall be secured to prevent movement. The material used to secure the pipe shall be approved by the Engineer. Place the Slope Drain Surface on undisturbed soil or well compacted fill. It is important to properly size the pipe and stabilize the outlet of these devices.

Material to be recommended or approved by the Engineer.

Optional Measures:

A Slope Drain Surface pipe may be used in conjunction with a Intercepting Ditch and Diversion Dike (E & S-10, 11, and 12).

A Gravel Filter Berm (E & S-13) may be used prior to entering the conduit when a bridge deck is undergoing hydrodemolition.

Related SESC Measures:

- E & S-7 Riprap
- E & S-10 Diversion Dike
- E & S-11 Intercepting Ditch
- E & S-12 Intercepting Ditch and Diversion Dike
- E & S-19 Energy Dissipators
- E & S-24 Sand and Stone Bags
- E & S-26 Silt Fence

Measurement and Payment:

There is no separate contract item for this E & S measure. Payment for Slope Drain Surface will be included in related items of work. Optional work shown, when installed and maintained as directed by the Engineer, will be paid using the associated contract item listed here.

<u>Contract Item (Pay Item)</u>	<u>Pay Unit</u>
Riprap, Plain	Square Yard
Riprap, Plain, LM	Cubic Yard
Erosion Control, Gravel Filter Berm	Foot
Erosion Control, Sand Bag	Each
Erosion Control, Stone Bag	Each

MICHIGAN DEPARTMENT OF TRANSPORTATION
BUREAU OF HIGHWAY DEVELOPMENT SESC DETAIL FOR

Slope Drain Surface

	04-07-2006 PLAN DATE	E&S-15-A	SHEET 1 OF 1
---	-------------------------	----------	-----------------

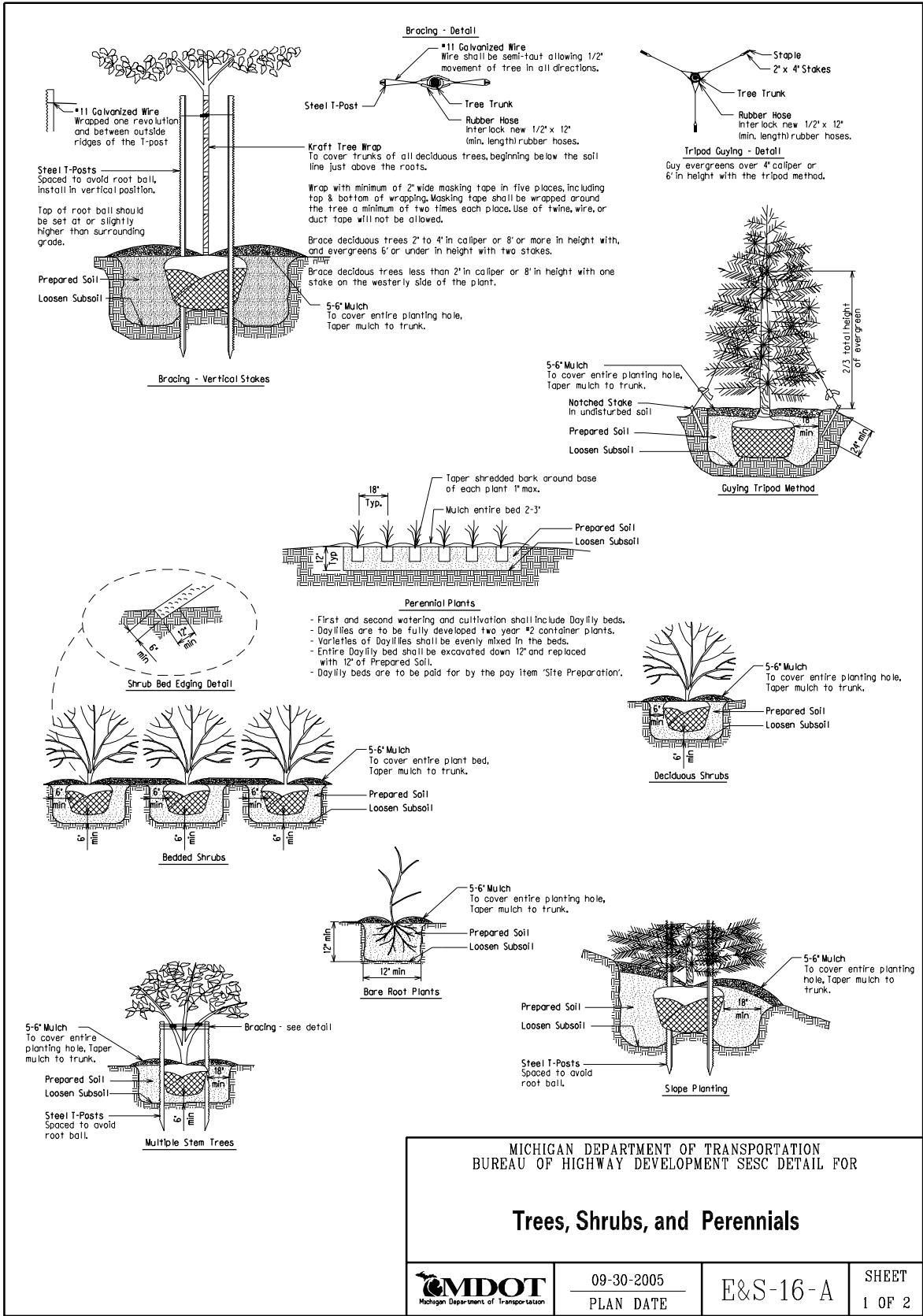

MICHIGAN DEPARTMENT OF TRANSPORTATION
BUREAU OF HIGHWAY DEVELOPMENT SESC DETAIL FOR

Trees, Shrubs, and Perennials



09-30-2005
PLAN DATE

E&S-16-A

SHEET
1 OF 2

Use:

Trees, shrubs, and some selected grasses and legumes can provide low maintenance, long-term erosion protection. These plants may be particularly useful where site aesthetics are important. There are many different species of plants to choose from and care must be taken in their selection. Assistance in selecting proper types of vegetation can be obtained from the Roadside Development Unit of the Design Support Area, or the Region Resource Specialist.

Woody plants are particularly adaptable for use on steep or rocky slopes where maintenance is difficult. They provide long-term erosion protection to slopes, including steep slopes (1 on 3 or greater).

Installation and Maintenance:

Planting trees, shrubs and evergreens

Specific planting requirements are as follows:

1. Dig plant pocket for deciduous and evergreen trees a minimum of 36" wider and 6" deeper than root ball unless otherwise specified.
2. Dig plant pocket for shrubs a minimum of 12" wider and 6" deeper than the root ball unless otherwise specified.
3. Loosen subsoil to a depth of 4". Loosen earth on sides of plant pocket to break any glazing caused by digging.
4. Set plant at the same or slightly higher depth than that at the nursery.
5. Fill prepared soil 1/2 the depth of the root ball, pack firmly and puddle with water.
6. Loosen and remove burlap and all lacing from upper half of the root ball.
7. Backfill remaining plant pocket with prepared soil and pack firmly. After compaction, the disturbed area should be flush with the surrounding ground.
8. Cover entire plant pocket area with 2 to 4 inches of mulch. Prune, wrap, brace and guy as specified.

Optional Measures:

Related SESC Measures:

- E & S-3 Permanent/Temporary Seeding
- E & S-28 Mulching and Mulch Anchoring
- E & S-33 Mulch Blankets and High Velocity Mulch Blankets

Measurement and Payment:

<u>Contract Item (Pay Item)</u>	<u>Pay Unit</u>
(Botanical Name)	Each

Refer to plans or contract documents for specific items as determined by the Roadside Development Unit of the Design Support Area. Refer to section 815 of the Standard Specifications for Construction for requirements for site preparation, watering and cultivating.

MICHIGAN DEPARTMENT OF TRANSPORTATION
BUREAU OF HIGHWAY DEVELOPMENT SESC DETAIL FOR

Trees, Shrubs, and Perennials



09-30-2005
PLAN DATE

E&S-16-A

SHEET
2 OF 2

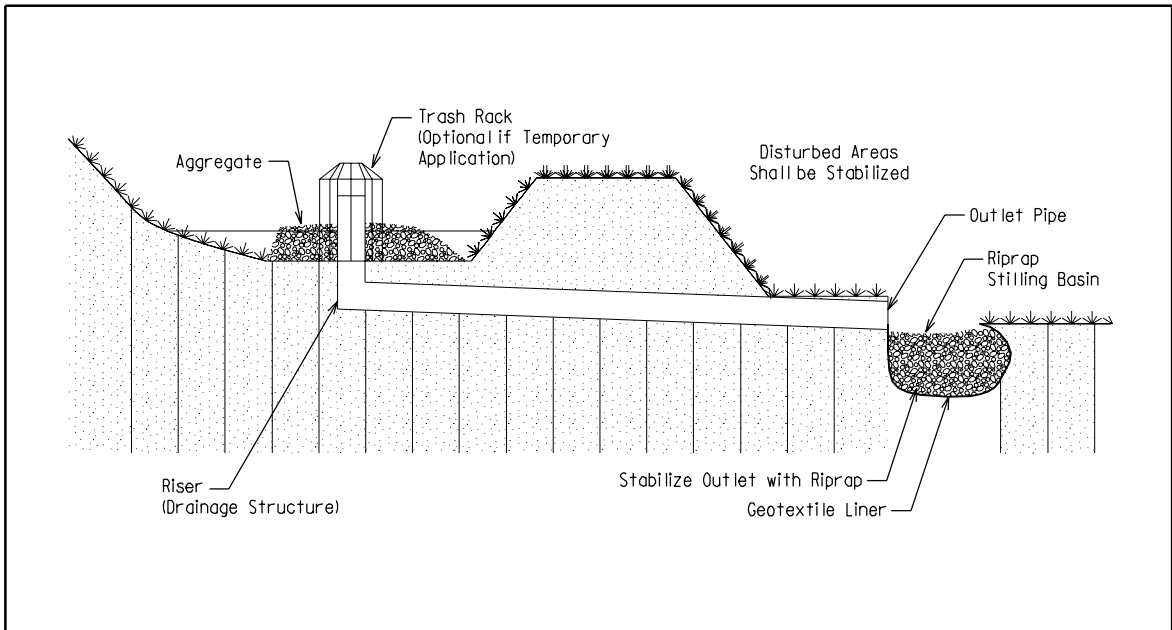

Use:

Refer to the Drainage Manual for additional design considerations when specifying this device.

A Pipe Drop is an effective way to allow water to drop or flow very rapidly down elevation without causing erosion and sedimentation to the down slope area. In addition, they function effectively as a sediment trap. A Pipe Drop is generally a permanent soil erosion and sedimentation control device.

Installation and Maintenance:

The size of the riser and outlet pipes shall be approved by the Engineer. If high outlet velocities are anticipated, the size and quantity of Riprap will also be determined by the Engineer. Energy Dissipators (E & S-19) may be required.

This device will require consultation with the Hydraulic/Hydrology Unit of the Design Support Area prior to specifying on the plans.

Optional Measures:

Energy Dissipators (E & S-19) may be required. For additional Energy Dissipators reference Standard Plan R-85 Series (outlet headwalls with baffles).

Installation of Trash Rack is optional for temporary Pipe Drop.

Related SESC Measures:

- E & S-7 Riprap
- E & S-19 Energy Dissipators

Measurement and Payment:

Pipe Drop requires inclusion of the appropriate Special Provision in the contract documents. Payment includes furnishing and installing Trash Rack, when specified, and stabilization of all disturbed area.

Refer to Special Provision for additional details.

<u>Contract Item (Pay Item)</u>	<u>Pay Unit</u>
---------------------------------	-----------------

MICHIGAN DEPARTMENT OF TRANSPORTATION BUREAU OF HIGHWAY DEVELOPMENT SESC DETAIL FOR			
Pipe Drop			
	04-07-2006 PLAN DATE	E&S-17-A	SHEET 1 OF 1

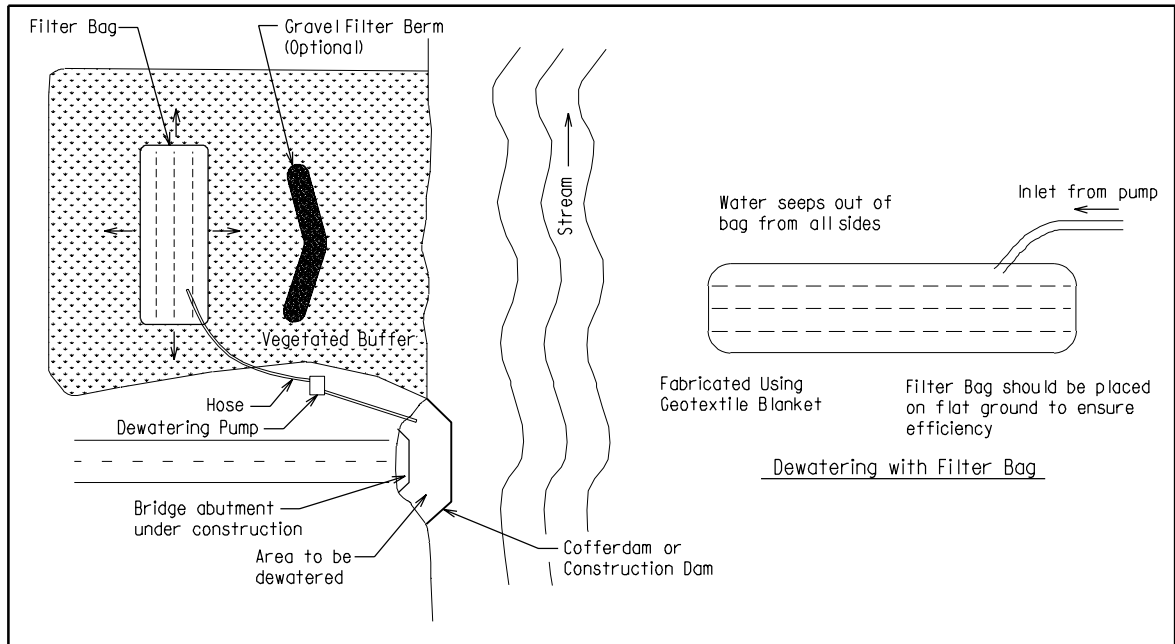

Use:

Dewatering operations may utilize a Filter Bag located a sufficient distance from the watercourse or wetland to allow for proper settling or filtering through natural vegetation.

Installation and Maintenance:

The Filter Bag must be of adequate size or the pumping rate must be reduced to still the water for a sufficient time to allow particles to settle.

When Dewatering with a Filter Bag on a barge, care shall be taken during the removal of the Filter Bag to ensure that sediment does not enter the watercourse.

Optional Measures:

Installation of a Gravel Filter Berm (E & S-13) may be required to provide additional sediment removal. Placement of a Sediment Basin (E & S-21) may be required if the water returning to the streams or wetland area remains turbid.

Related SESC Measures:

- E & S-13 Gravel Filter Berm
- E & S-20 Sediment Trap
- E & S-21 Sediment Basin
- E & S-34 Cofferdam
- E & S-36 Construction Dam

Measurement and Payment:

Dewatering and associated E & S measures are generally not paid for separately but are included in related items of work. When a Filter Bag is used to aid in removing sediment, it will be paid for separately. Optional work shown, when installed and maintained as directed by the Engineer, will be paid using the associated contract items listed here unless otherwise specified.

<u>Contract Item (Pay Item)</u>	<u>Pay Unit</u>
Erosion Control, Sediment Basin	Cubic Yard
Erosion Control, Maintenance, Sediment Removal	Cubic Yard
Erosion Control, Gravel Filter Berm	Foot
Erosion Control, Filter Bag	Each

PERMITS FROM THE MICHIGAN DEPARTMENT OF ENVIRONMENTAL QUALITY MAY BE REQUIRED.

MICHIGAN DEPARTMENT OF TRANSPORTATION
BUREAU OF HIGHWAY DEVELOPMENT SESC DETAIL FOR

Dewatering with Filter Bag

	04-07-2006	E&S-18-A	SHEET 1 OF 1
	PLAN DATE		

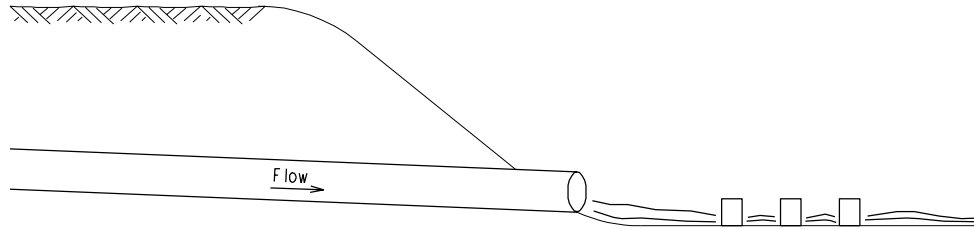

Use:

Refer to the Drainage Manual for additional design considerations when specifying this device.

Energy Dissipators must be designed by a Hydraulic Engineer. The Hydraulic Engineer will determine the outlet velocities and the size and type of the structural device.

Energy Dissipators are structures used to control erosion at the outlet of a channel or conduit. Energy Dissipators reduce the velocity of flow and dissipate the energy. This practice applies where the discharge velocity of a pipe, box culvert, diversion, open channel or other water conveyance structure exceeds the erodible velocity of the receiving channel or disposal area.

Energy Dissipators are generally not required or recommended on natural watercourses since stream crossing structures must be designed without excessive stream velocities or potentially damaging back water.

Riprap (E & S-7) stilling basins or plunge pools work well and rapidly reduce flow velocity. They should be considered in lieu of concrete aprons or other rigid structures.

For other Energy Dissipator details, reference Standard Plan R-85 Series (outlet headwalls with baffles).

Installation and Maintenance:

Follow manufacturer's recommendations and contract documents for installation and maintenance of prefabricated or site built Energy Dissipators.

Optional Measures:

Related SESC Measures:

E & S-7 Riprap

Measurement and Payment:

Unless otherwise specified, there is no separate Pay Item for this E & S measure.

Riprap may be included as a Pay Item using one of the following contract items.

Contract Item (Pay Item)	Pay Unit
Riprap, Heavy	Square Yard
Riprap, Heavy, LM	Cubic Yard
Riprap, Plain	Square Yard
Riprap, Plain, LM	Cubic Yard
Riprap, Grouted	Square Yard

Note: Gradations and dimensions of Riprap may be modified by Special Provision

PERMITS FROM THE MICHIGAN DEPARTMENT OF ENVIRONMENTAL QUALITY MAY BE REQUIRED.

MICHIGAN DEPARTMENT OF TRANSPORTATION
BUREAU OF HIGHWAY DEVELOPMENT SESC DETAIL FOR

Energy Dissipators



04-07-2006
PLAN DATE

E&S-19-A

SHEET
1 OF 1

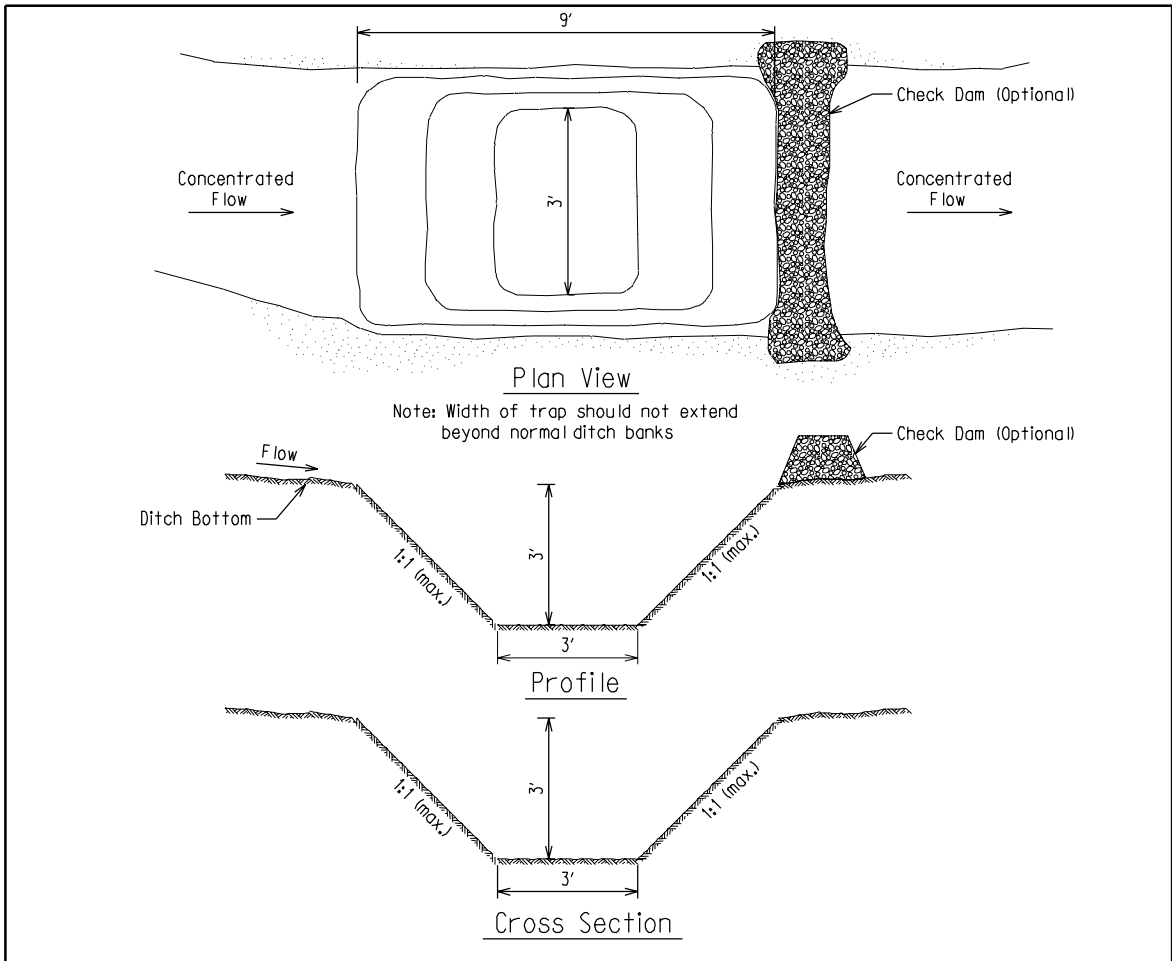

Use:

Refer to the Drainage Manual for additional design considerations when specifying this device.

A Sediment Trap can be used in any area where concentrated flow would result in the transport of sediments off site into a body of water or wetland area. A Sediment Trap is an effective device used to settle out sand sized particles and larger. The size of a Sediment Trap is 5 cubic yards or less.

Installation and Maintenance:

Sediment Trap dimensions are highly variable as required by project site conditions. Sediment should be removed and the Sediment Trap restored to its original design when the sediment has accumulated up to approximately 50 percent of its capacity.

Optional Measures:

A Check Dam (E & S-37) may be used in conjunction with the Sediment Trap. The Check Dam should be located immediately down slope of the Sediment Trap. Multiple traps may be required, as recommended by the Engineer.

Related SESC Measures:

E & S-37 Check Dam

Measurement and Payments:

Optional work shown, when installed and maintained as directed by the Engineer, will be paid using the associated contract item listed here.

<u>Contract Item (Pay Item)</u>	<u>Pay Unit</u>
Erosion Control, Sediment Trap	Each
Erosion Control, Maintenance, Sediment Removal	Cubic Yard
Erosion Control, Check Dam, Stone	Foot

MICHIGAN DEPARTMENT OF TRANSPORTATION
BUREAU OF HIGHWAY DEVELOPMENT SESC DETAIL FOR

Sediment Trap

PERMITS FROM THE MICHIGAN DEPARTMENT OF ENVIRONMENTAL QUALITY MAY BE REQUIRED.



04-07-2006
PLAN DATE

E&S-20-A

SHEET
1 OF 1

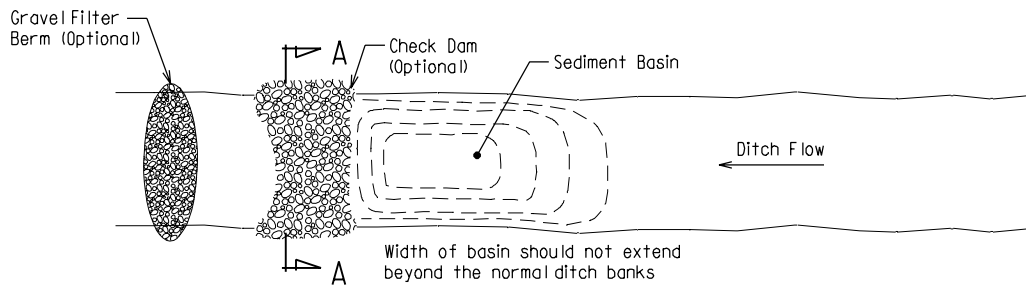

Plan View

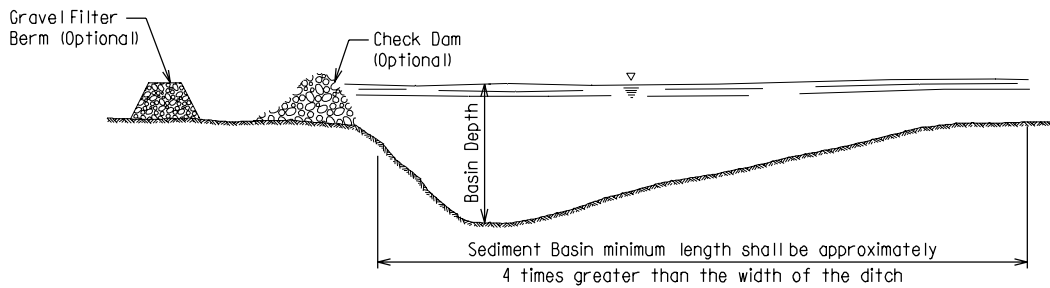

Profile View

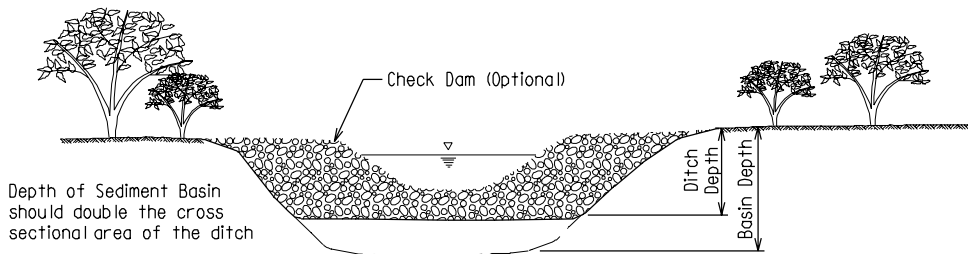

Section A-A

MICHIGAN DEPARTMENT OF TRANSPORTATION
BUREAU OF HIGHWAY DEVELOPMENT SESC DETAIL FOR

Sediment Basin



04-07-2006
PLAN DATE

E&S-21-A

SHEET
1 OF 2

Use:

Refer to the Drainage Manual for additional design considerations when specifying this device.

A Sediment Basin should be used as a last effort to collect sediments. Whenever possible, sediments shall be prevented from reaching the ditch (or watercourse if basin is permitted) by the use of Construction Dam (E & S-36), Cofferdam (E & S-34), Gravel Filter Berm (E & S-13), Sediment Trap (E & S-20), Silt Fence (E & S-26), Temporary Bypass Channel (E & S-35), Dewatering with Filter Bag (E & S-18), or Diversion Dike (E & S-10), Intercepting Ditch (E & S-11), or Intercepting Ditch and Diversion Dike (E & S-12). These devices will isolate the construction activity from the ditch (or watercourse if permitted).

NOTE: Sediment Basins are allowed in streams by permit only.

Installation and Maintenance:

A Sediment Basin is an effective device used to settle out sand sized particles and larger. Sediment Basin is greater than 5 cubic yards.

The width of the Sediment Basin should not extend beyond the ditch slope. The length of the Sediment Basin shall be approximately four times greater than the stream width.

The Basin must be periodically cleaned when it reaches approximately 50 percent of its capacity under the pay item Erosion Control, Maintenance, Sediment Removal. Upon stabilization of the construction area, the basin shall receive a final cleaning and the Check Dam removed.

Optional Measures:

A Check Dam (E & S-37), may be used and shall be located immediately downslope of the Sediment Basin.

A Gravel Filter Berm (E & S-13) may be installed downslope of the Sediment Basin and Check Dam to provide additional sediment removal.

Related SESC Measures:

- E & S-10 Diversion Dike
- E & S-11 Intercepting Ditch
- E & S-12 Intercepting Ditch and Diversion Dike
- E & S-13 Gravel Filter Berm
- E & S-18 Dewatering with Filter Bag
- E & S-20 Sediment Trap
- E & S-24 Sand and Stone Bags
- E & S-26 Silt Fence
- E & S-34 Cofferdam
- E & S-35 Temporary Bypass Channel
- E & S-36 Construction Dam
- E & S-37 Check Dam

Measurement and Payment:

Optional work shown, when installed and maintained as directed by the Engineer, will be paid using the associated contract item listed here.

<u>Contract Item (Pay Item)</u>	<u>Pay Unit</u>
Erosion Control, Sediment Basin	Cubic Yard
Erosion Control, Maintenance, Sediment Removal	Cubic Yard
Erosion Control, Check Dam, Stone	Foot
Erosion Control, Gravel Filter Berm	Foot

PERMITS FROM THE MICHIGAN DEPARTMENT OF ENVIRONMENTAL QUALITY WILL BE REQUIRED.

MICHIGAN DEPARTMENT OF TRANSPORTATION
BUREAU OF HIGHWAY DEVELOPMENT SESC DETAIL FOR

Sediment Basin



04-07-2006
PLAN DATE

E&S-21-A

SHEET
2 OF 2

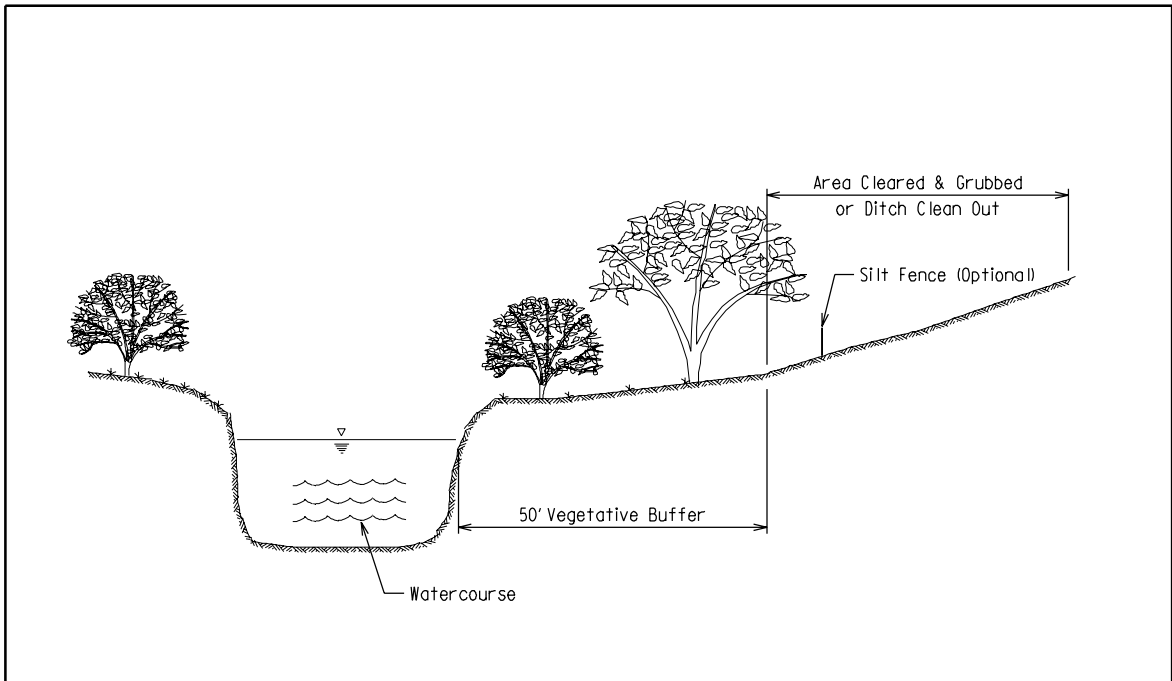

Use:

Vegetative Buffer at Watercourse is used along the toe of slopes to filter sediment from runoff. Vegetative Buffer is also used during ditch clean out operations.

Installation and Maintenance:

Silt Fence, if used, should be placed down slope and immediately adjacent to the Vegetative Buffer at Watercourse to ensure that sediments do not migrate into the watercourse or wetland. If clearing and grubbing is necessary up to the waters edge, the clearing adjacent to the watercourse should be done after the up-slope area is adequately stabilized to prevent erosion and subsequent siltation.

Optional Measures:

A Silt Fence (E & S-26) or Diversion Dike (E & S-10), Intercepting Ditch (E & S-11) or Intercepting Ditch and Diversion Dike (E & S-12) can also be used at the top of the graded area to prevent runoff from flowing down the raw slope.

Related SESC Measures:

- E & S-2 Grubbing Omitted
- E & S-3 Permanent/Temporary Seeding
- E & S-10 Diversion Dike
- E & S-11 Intercepting Ditch
- E & S-12 Intercepting Ditch and Diversion Dike
- E & S-26 Silt Fence

Measurement and Payment:

There is no separate contract item for this E & S measure. Payment for Vegetative Buffer at Watercourse will be included in related items of work. Optional work shown, when installed and maintained as directed by the Engineer, will be paid using the associated contract item listed here.

<u>Contract Item (Pay Item)</u>	<u>Pay Unit</u>
Erosion Control, Silt Fence	Foot

MICHIGAN DEPARTMENT OF TRANSPORTATION
BUREAU OF HIGHWAY DEVELOPMENT SESC DETAIL FOR

Vegetative Buffer at Watercourse



04-07-2006
PLAN DATE

E&S-22-A

SHEET
1 OF 1

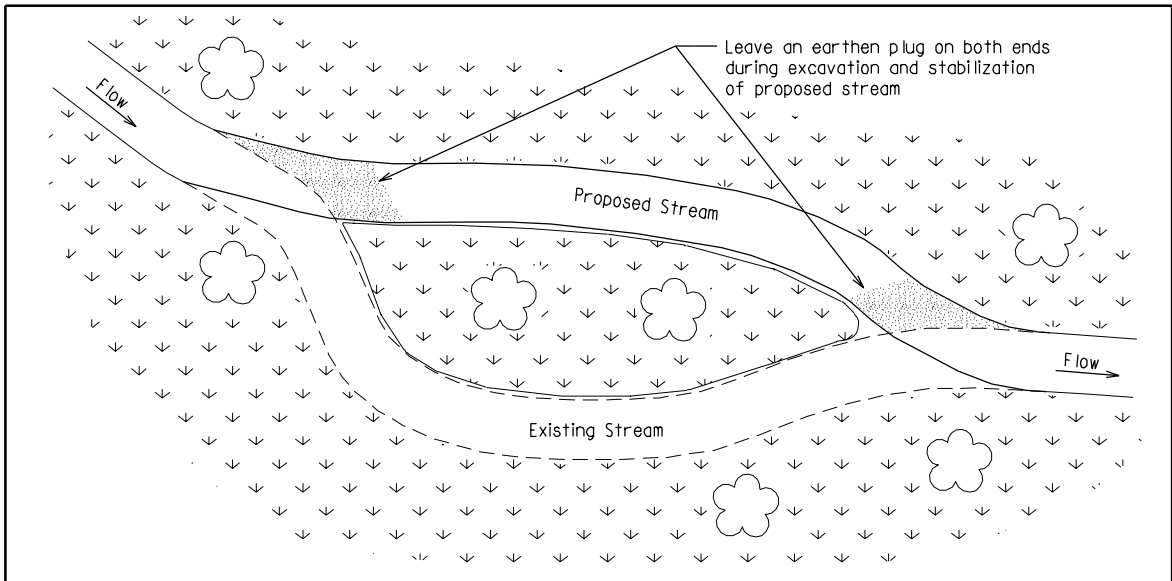

Use:

Refer to the Drainage Manual for additional design considerations when specifying this device.

When a Stream Relocation is specified it shall be designed by an Engineer. Certain habitat structures may be incorporated into its design to mitigate for habitat impacts. These structures include, but are not limited to, rock weirs, plumbs, and others as specified by the Michigan Department of Environmental Quality (MDEQ) Permit Provisions. This device requires consultation with the Hydraulics/Hydrology Unit of the Design Support Area prior to specifying on the plans.

Installation and Maintenance:

Example of Construction Sequence and Controls:

1. Excavate new stream leaving an earthen plug at the upstream and downstream ends.
2. Dewater new stream in accordance with Dewatering with Filter Bag (E & S-18).
3. Install structures if required by MDEQ Permit Provisions and plans.
4. Place Geotextile Blanket over the entire stream bed and banks.
5. Place Stream Bed Protection.
6. Stabilize all disturbed areas.
7. When the stream is stable, remove the downstream plug, then remove the upstream plug.
8. Create a plug at the upstream and downstream end of the old channel and backfill old channel.
9. Stabilize backfill areas.

Optional Measures:

Dewatering with Filter Bag (E & S-18) may be required where vegetated area is not available for filtering.

Related SESC Measures:

- E & S-3 Permanent/Temporary Seeding
- E & S-7 Riprap
- E & S-18 Dewatering with Filter Bag
- E & S-28 Mulching and Mulch Anchoring
- E & S-33 Mulch Blankets and High Velocity Mulch Blankets
- E & S-37 Check Dam

Measurement and Payment:

Stream Relocation, including optional work shown, when installed and maintained as directed by the Engineer, will be paid using the associated contract item listed here.

Contract Item (Pay Item)	Pay Unit
Excavation, Channel	Cubic Yard
Riprap, Heavy	Square Yard
Riprap, Heavy, LM	Cubic Yard
Riprap, Special	By Special Provision
Erosion Control, Streambed Protection	By Special Provision
Erosion Control, Filter Bag	Each

PERMITS FROM THE MICHIGAN DEPARTMENT OF ENVIRONMENTAL QUALITY WILL BE REQUIRED.

MICHIGAN DEPARTMENT OF TRANSPORTATION BUREAU OF HIGHWAY DEVELOPMENT SESC DETAIL FOR			
Stream Relocation			
	04-07-2006 PLAN DATE	E&S-23-A	SHEET 1 OF 1

Examples showing Sand or Stone Bags

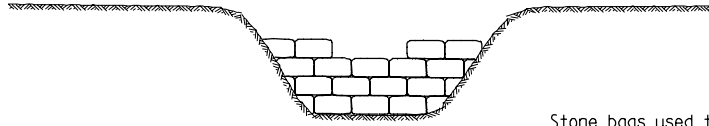

Stone bags used to create a Check Dam

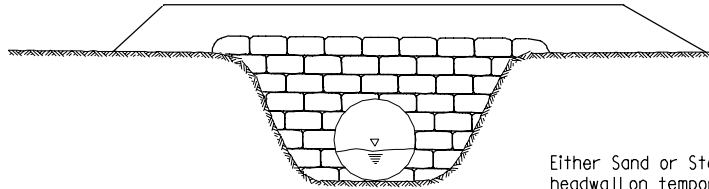

Either Sand or Stone Bags used as headwall on temporary culvert crossing

Use:

Sand and Stone Bags are a useful tool in the prevention of erosion and subsequent sedimentation. Sand Bags can be used to divert water around a construction area or create a Construction Dam (E & S-36) to afford a slack water area or dry construction site.

Stone Bags also work well as temporary Check Dam. Sand or Stone Bags may be used as temporary Culvert Headwalls.

Sand and Stone Bags should never be used as a filtering device since they do not allow for adequate movement of water and are subject to failure.

Installation and Maintenance:

Layers of stone or sand bags should be staggered and placed tightly together. Bottom layer of bags should be trenched in.

Optional Measures:

Related SESC Measures:

- E & S-10 Diversion Dike
- E & S-23 Stream Relocation
- E & S-35 Temporary Bypass Channel
- E & S-36 Construction Dam

Measurement and Payment:

<u>Contract Item (Pay Item)</u>	<u>Pay Unit</u>
Erosion Control, Sand Bag	Each
Erosion Control, Stone Bag	Each

PERMITS FROM THE MICHIGAN DEPARTMENT OF ENVIRONMENTAL QUALITY MAY BE REQUIRED.

MICHIGAN DEPARTMENT OF TRANSPORTATION
BUREAU OF HIGHWAY DEVELOPMENT SESC DETAIL FOR

Sand and Stone Bags



04-07-2006
PLAN DATE

E&S-24-A

SHEET
1 OF 1

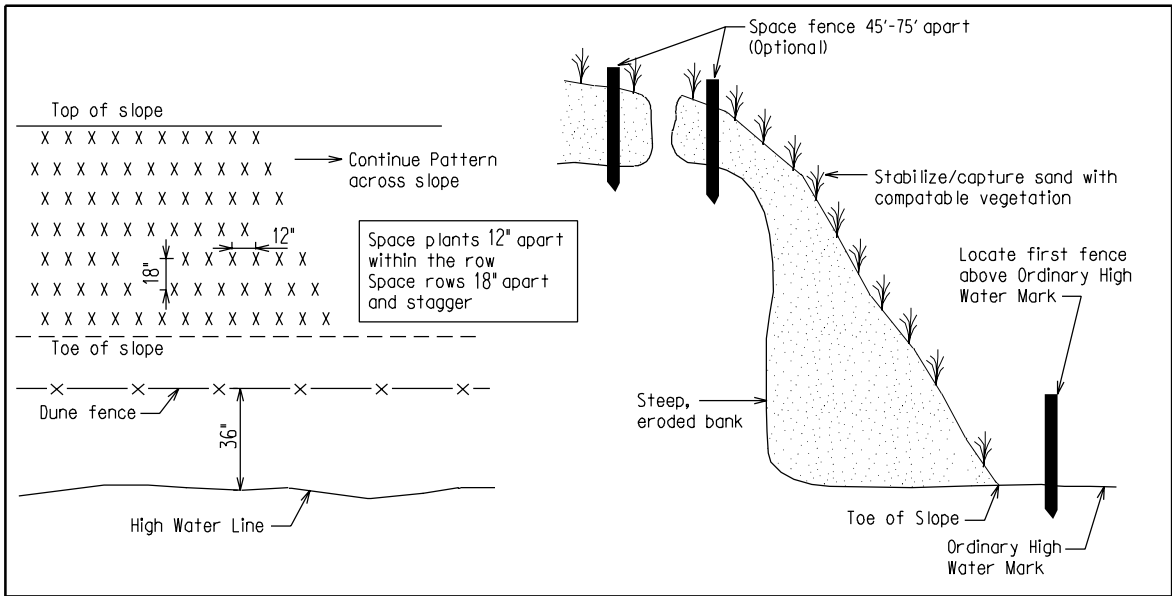

Use:

A Sand Fence is made of wood or plastic and is installed perpendicular to the prevailing wind. The fence traps blowing sand by reducing the wind velocity at the ground surface. Dune grass is planted to stabilize the area.

Installation and Maintenance:

These fences can be used to prevent sand from blowing onto roads or off-site areas. A Sand Fence works well for building up areas of sand where blowouts have occurred. When re-establishing a dune, a Sand Fence should be installed in spring or early summer. Install a windward Sand Fence parallel to the existing dune, generally perpendicular to the prevailing on-shore wind, above the ordinary high water mark. Support fencing material with sturdy posts. Revegetation of the dune shall be in accordance with the Standard Specifications for Construction Section 818, Dune Grass Planting and the contract documents.

Optional Measures:

Additional parallel fences may be needed.

Related SESC Measures:

Measurement and Payment:

Optional work shown, when installed and maintained as directed by the Engineer, will be paid using the associated contract item listed here.

Contract Item (Pay Item)	Pay Unit
Erosion Control, Sand Fence	Foot
Dune Grass Planting	Square yard

MICHIGAN DEPARTMENT OF TRANSPORTATION
BUREAU OF HIGHWAY DEVELOPMENT SESC DETAIL FOR

Sand Fence and Dune Stabilization



09-30-2005
PLAN DATE

E&S-25-A

SHEET
1 OF 1

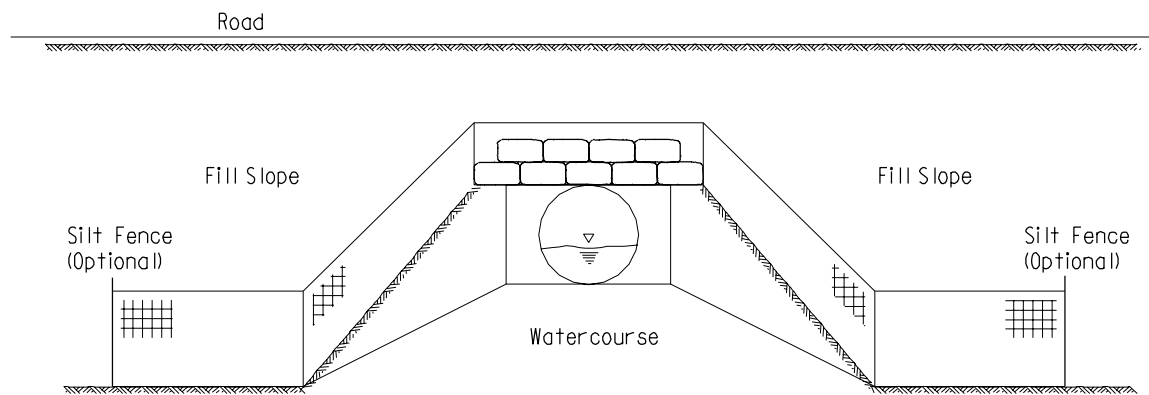
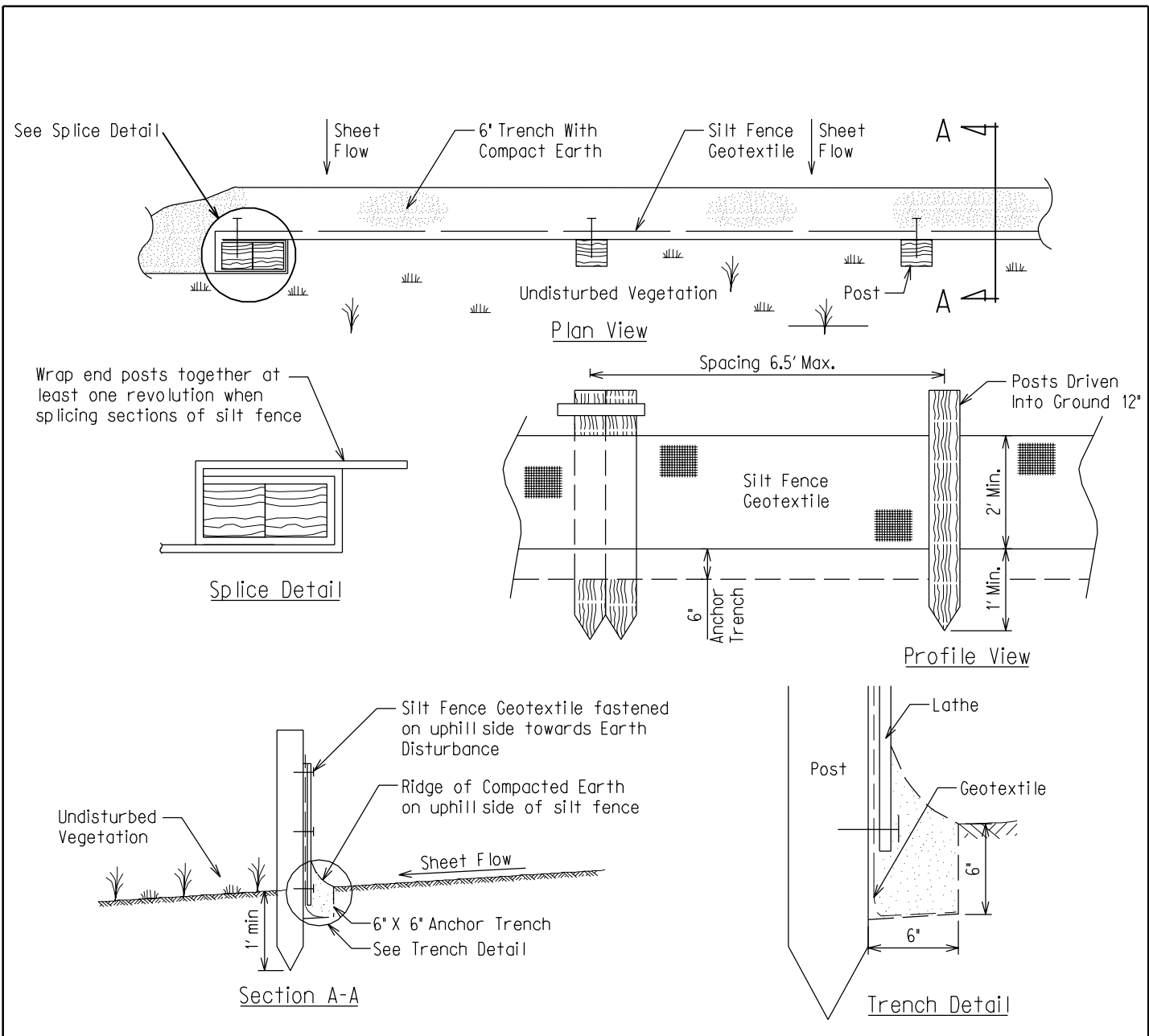

MICHIGAN DEPARTMENT OF TRANSPORTATION
BUREAU OF HIGHWAY DEVELOPMENT SESC DETAIL FOR

Silt Fence



09-30-2005
PLAN DATE

E&S-26-A

SHEET
1 OF 2

Use:

A Silt Fence is a permeable barrier erected adjacent to disturbed areas to capture sediment from sheet flow. It is made of woven geotextile fabric which is stretched and supported by wooden posts and trenched in at the bottom.

The Silt Fence retards the movement of sediment-laden water allowing the deposition and retention of sediment.

Do not install Silt Fence across streams or ditches where flows are concentrated.

The use of a Silt Fence should never be substituted for the application of permanent or temporary vegetative cover.

Installation and Maintenance:

It is critical to thoroughly trench in the bottom of Silt Fence as shown to maximize its performance and to prevent failure from undercutting, overtopping or collapsing. Geotextile should extend along side and bottom of trench.

Ensure that stable overflow outlets are available.

Remove all sediment from behind Silt Fence when it reaches approximately 50 percent of its capacity and make repairs promptly.

Silt Fence shall remain in place and properly maintained until the disturbed area is completely stabilized.

Optional Measures:

As an extra precautionary measure when there is a steep disturbed area adjacent to a watercourse, two rows of Silt Fence may be placed.

Sand and Stone Bags (E & S-24) may be used to provide additional support for Silt Fence. Installed at culvert extensions as shown in the detail above

Related SESC Measures:

- E & S-2 Grubbing Omitted
- E & S-6 Vegetative Buffer Strips
- E & S-9 Benches
- E & S-24 Sand and Stone Bags
- E & S-28 Mulching and Mulch Anchoring
- E & S-32 Surface Roughening and Scarification
- E & S-33 Mulch Blankets and High Velocity Mulch Blankets.

Measurement and Payment:

Optional work shown, when installed and maintained as directed by the Engineer, will be paid using the associated contract item listed here.

<u>Contract Item (Pay Item)</u>	<u>Pay Unit</u>
Erosion Control, Silt Fence	Foot
Erosion Control, Maintenance, Sediment Removal	Cubic Yard
Erosion Control, Sand Bag	Each
Erosion Control, Stone Bag	Each

MICHIGAN DEPARTMENT OF TRANSPORTATION
BUREAU OF HIGHWAY DEVELOPMENT SESC DETAIL FOR

Silt Fence



04-07-2006
PLAN DATE

E&S-26-A

SHEET
2 OF 2

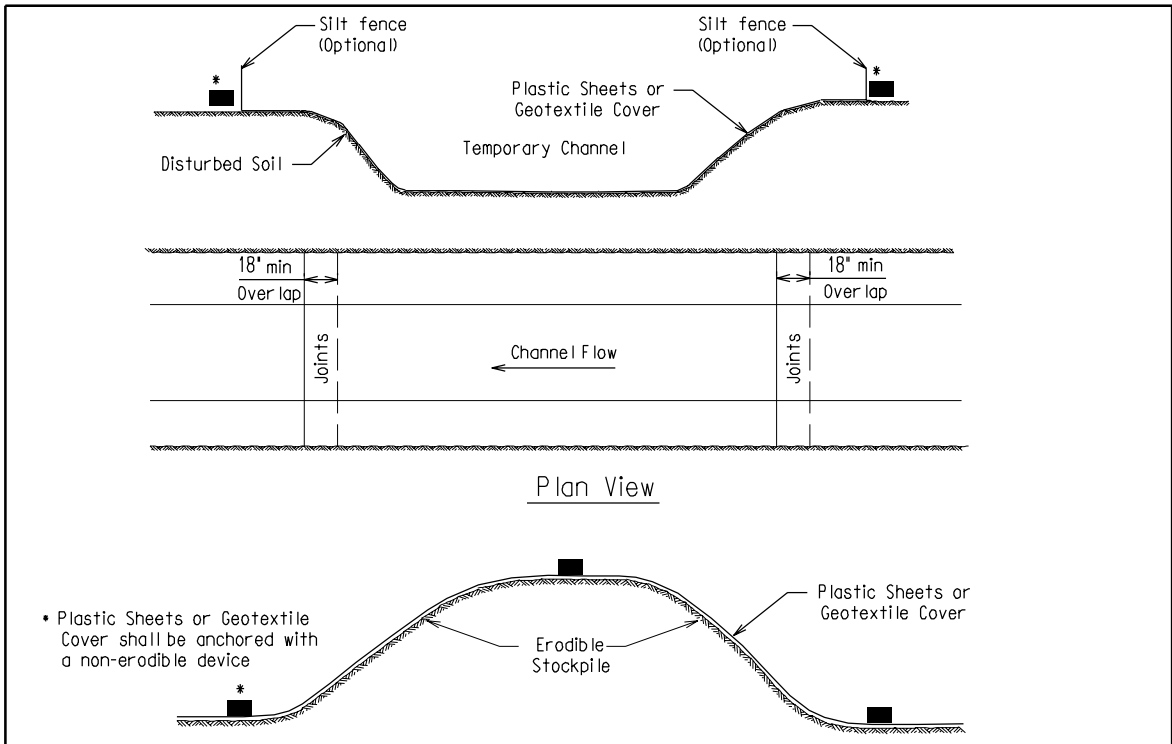

Use:

Plastic Sheets or Geotextile Cover can be used to create a liner in temporary channels or to create a temporary cover to prevent erosion from rain or wind on stockpiled materials or other small erodible areas.

Plastic Sheets or Geotextile Cover should not be used in lieu of permanent stabilization measures.

Installation and Maintenance:

When used as a temporary channel liner the plastic sheeting should be laid in a manner which will minimize the number of joints. Where two pieces of plastic must be joined they shall be overlapped a minimum of 18 inches in the downstream direction. Joints should be secured with non-erodible device as approved by the Engineer.

Plastic Sheets or Geotextile Cover shall be held down by use of Sand and Stone Bags (E & S-24) or other non-erodible device approved by the Engineer.

Optional Measures:

Silt fence may be installed on one or both sides of the temporary channel as shown.

Related SESC Measures:

- E & S-3 Permanent/Temporary Seeding
- E & S-24 Sand and Stone Bags
- E & S-26 Silt Fence

Measurement and Payment:

Optional work shown, when installed and maintained as directed by the Engineer, will be paid using the associated contract item listed here.

Stone or Sand Bags used to anchor Plastic Sheets or Geotextile Cover as shown will be included in payment for Erosion Control, Temp. Plastic Sheets/Geotextile Cover unless specified otherwise and approved by the Engineer.

Contract Item (Pay Item)	Pay Unit
Erosion Control, Temp. Plastic Sheet/Geotextile Cover	Square Yard
Erosion Control, Sand Bag	Each
Erosion Control, Stone Bag	Each
Erosion Control, Silt Fence	Foot

PERMITS FROM THE MICHIGAN DEPARTMENT OF ENVIRONMENTAL QUALITY MAY BE REQUIRED.

MICHIGAN DEPARTMENT OF TRANSPORTATION BUREAU OF HIGHWAY DEVELOPMENT SESC DETAIL FOR			
Plastic Sheets or Geotextile Cover			
	04-07-2006 PLAN DATE	E&S-27-A	SHEET 1 OF 1

Use:

Mulching and Mulch Anchoring provides erosion protection and promotes growth of vegetation. This is one of the most important, effective and economical erosion control practices available.

Installation and Maintenance:

The in-place mulch shall be loose or open enough to allow some sunlight and air to penetrate to the soil. The mulch should be thick enough to shade the ground, conserve soil moisture and prevent or reduce wind and water erosion.

Mulch should be anchored.

Mulch should not be used in areas where flowing water will occur or adjacent to the shoulder of the roadway, unless approved by the Engineer.

Loose mulch material shall consist of any straw or marsh hay in an air-dry condition. Hay in an air-dry condition will be permitted only when straw mulch or marsh hay is unavailable. Mulch material shall be clean, undamaged and rot free. It shall be substantially free of weeds and other objectionable foreign matter.

Optional Measures:

When hay is permitted, herbicide application, if necessary, shall be applied as per specification. Herbicide application shall be made at the contractor's expense.

Mulching and Mulch Anchoring shall be in accordance with Michigan Department of Transportation Standard Specifications for Construction Section 816 Turf Establishment and Standard Plan R-100 Series.

Related SESC Measures:

- E & S-3 Permanent/Temporary Seeding
- E & S-33 Mulch Blankets and High Velocity Mulch Blankets

Measurement and Payment:

<u>Contract Item (Pay Item)</u>	<u>Pay Unit</u>
Mulch	Square Yard
Mulch Anchoring	Square Yard

MICHIGAN DEPARTMENT OF TRANSPORTATION
BUREAU OF HIGHWAY DEVELOPMENT SESC DETAIL FOR

Mulching and Mulch Anchoring



09-30-2005
PLAN DATE

E&S-28-A

SHEET
1 OF 1

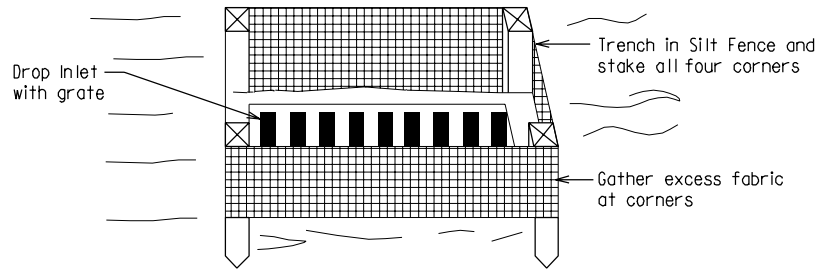

Inlet Protection in Unpaved Area

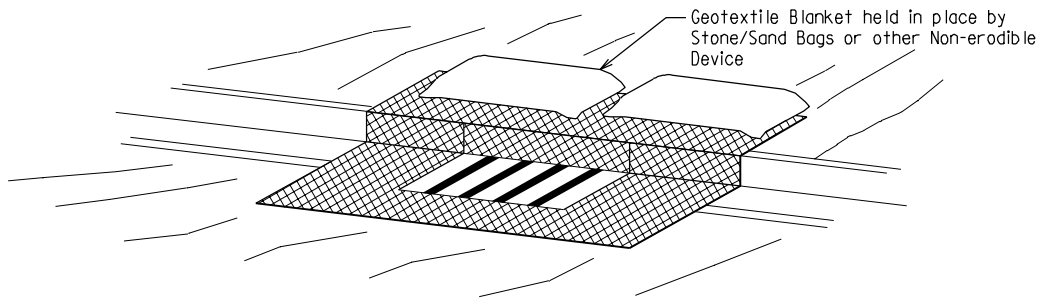

Plan View Inlet in Curb - Paved Area Behind Curb

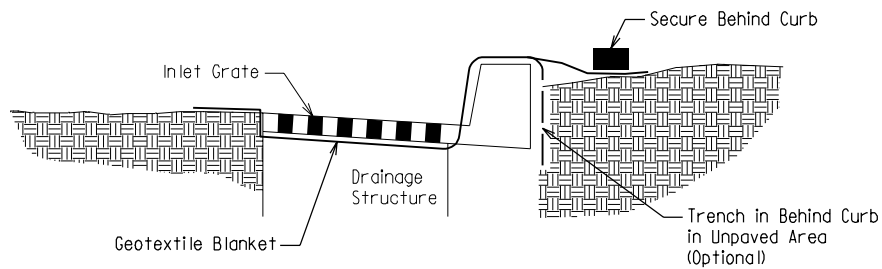

Cross Section Inlet in Curb - Paved or Unpaved Area Behind Curb

MICHIGAN DEPARTMENT OF TRANSPORTATION
BUREAU OF HIGHWAY DEVELOPMENT SESC DETAIL FOR

Inlet Protection Fabric Drop



04-07-2006
PLAN DATE

E&S-29-A

SHEET
1 OF 2

Use:

Inlet Protection Fabric Drop is a temporary device used to prevent sediment from entering drainage structure inlets.

Installation and Maintenance:

Inlet Protection Fabric Drop requires frequent maintenance to function properly.

For drainage structures not located in the curb, Silt Fence (E & S-26) is installed around the outside of the drainage structure. The Silt Fence must be trenched in on all sides.

For drainage structures with covers located in the curb, a nonwoven geotextile blanket is installed between the cover and the frame of the drainage structure cover. The Geotextile Blanket must be trenched in or otherwise held in place behind the curb line.

If the inlet protection is placed prior to the installation of the cover, wire mesh shall be placed over the opening to support the Geotextile Blanket.

Care must be taken when removing fabric to prevent loss of sediment into the inlet.

Optional Measures:

For those instances where the volume of storm water may be high, a Gravel Filter Berm (E & S-13) may be installed in one corner of the Inlet Protection Fabric Drop to enable storm water to be filtered prior to entering the drainage structure.

Trench in fabric behind curb in unpaved areas if this will not result in exposing undisturbed area to accelerated erosion.

Related SESC Measures:

- E & S-13 Gravel Filter Berm
- E & S-31 Drop Inlet Protection Sediment Trap

Measurement and Payment:

Payment for Inlet Protection Fabric Drop includes all labor and materials required to secure Geotextile Fabric as shown. Optional work shown, when installed and maintained as directed by the Engineer, will be paid using the associated contract items listed here.

<u>Contract Item (Pay Item)</u>	<u>Pay Unit</u>
Erosion Control, Inlet Protection, Fabric Drop	Each
Erosion Control, Gravel Filter Berm	Foot
Erosion Control, Silt Fence	Foot
Erosion Control, Maintenance, Sediment Removal	Cubic Yard

MICHIGAN DEPARTMENT OF TRANSPORTATION
BUREAU OF HIGHWAY DEVELOPMENT SESC DETAIL FOR

Inlet Protection Fabric Drop



04-07-2006
PLAN DATE

E&S-29-A

SHEET
2 OF 2

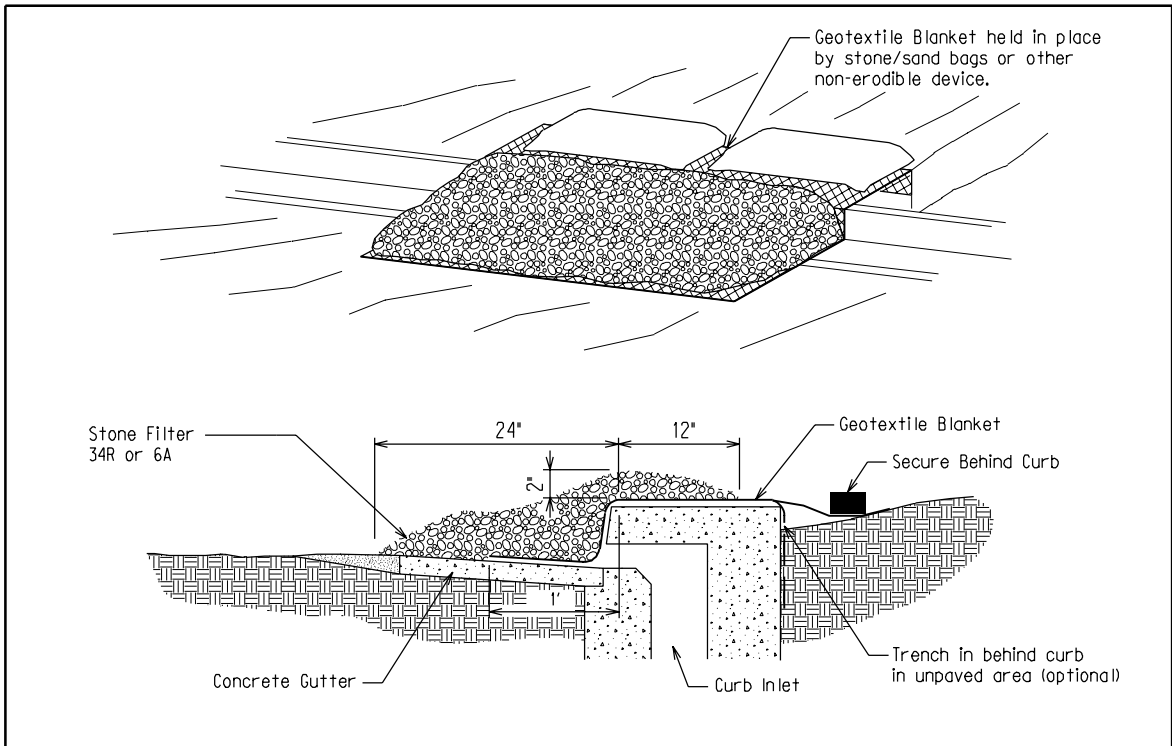

Use:

The Inlet Protection Geotextile and Stone is a recommended sedimentation control device in paved areas and some small drainage areas. Especially useful where there is no cover or inlet as in the curb inlet shown.

Installation and Maintenance:

This device can be used on storm inlets at curb openings where flows are minimal. It consists of geotextile blanket placed on top of the structure covered with clean stone such as 34R or 6A aggregate. The Geotextile Blanket must be trenched in or otherwise held in place behind the curb line.

This method of inlet protection is applicable at curb inlets, where ponding in front of the structure is not likely to cause inconvenience or damage to adjacent structures and unprotected areas.

If the device is to be placed prior to the installation of the grate, a wire mesh shall be placed over the opening to support the Geotextile Blanket and Stone.

Care must be taken when removing stone and fabric to prevent loss of sediment into the inlet.

Optional Measures:

Trench in fabric behind curb in unpaved areas if this will not result in exposing undisturbed area to accelerated erosion.

Related SESC Measures:

Measurement and Payment:

Payment for Inlet Protection Geotextile and Stone includes all labor and materials required to secure Geotextile Fabric as shown and to maintain the device as necessary.

Contract Item (Pay Item)	Pay Unit
Erosion Control, Inlet Protection, Geotextile and Stone	Each

MICHIGAN DEPARTMENT OF TRANSPORTATION BUREAU OF HIGHWAY DEVELOPMENT SESC DETAIL FOR			
Inlet Protection Geotextile and Stone			
	04-07-2006 PLAN DATE	E&S-30-A	SHEET 1 OF 1

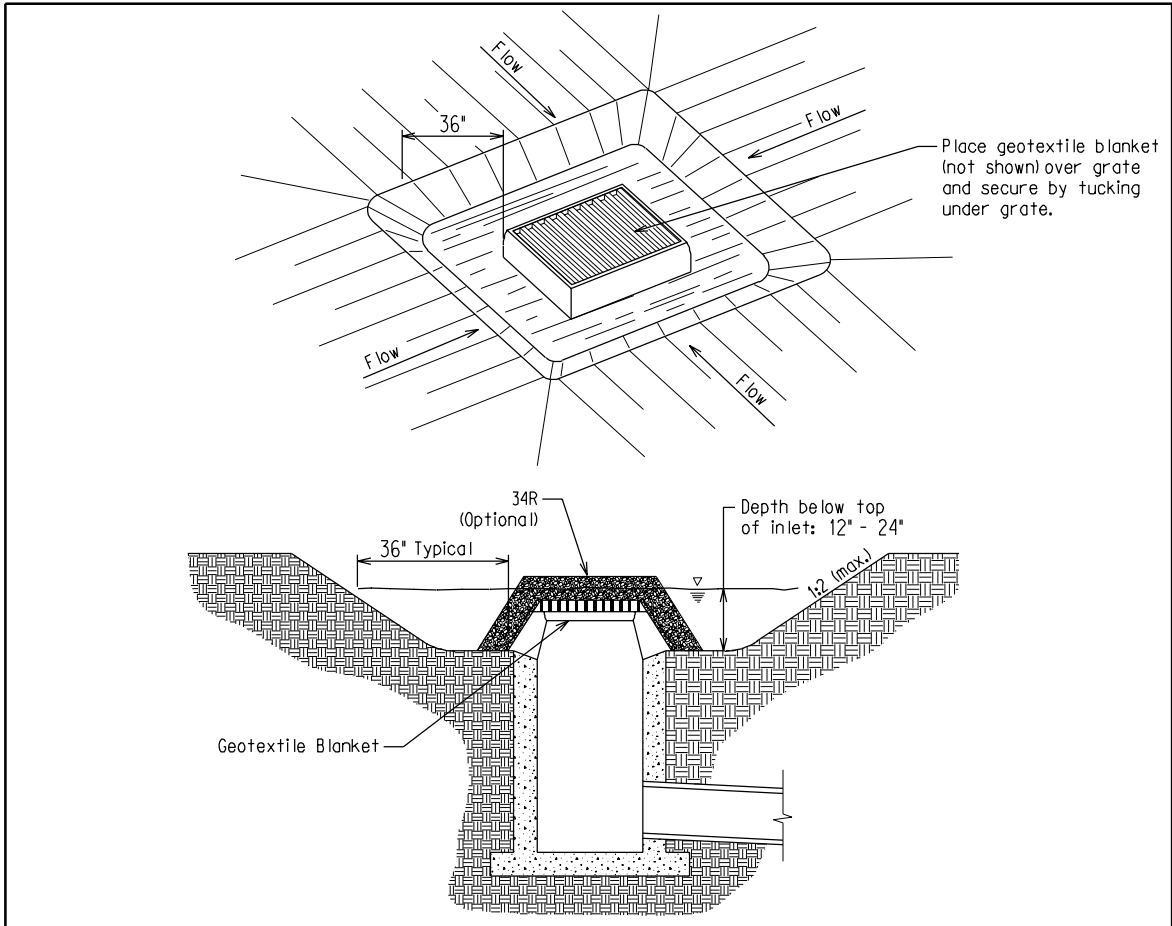

Use:

An Inlet Protection Sediment Trap is a temporary device that can be used in areas where minimal flows are anticipated.

Installation and Maintenance

At all times the inlet shall be protected with a nonwoven geotextile blanket. The nonwoven geotextile blanket shall be placed over the inlet of the structure and tucked under the grate to hold it in place.

When the sediment has accumulated to approximately 50 percent the design depth of the trap, it should be removed and the trap restored to the original dimensions. The trap should be maintained daily as needed.

Optional Measures:

A layer of 34R aggregate may be installed over the geotextile and grate to provide additional sedimentation control. Support for the Pea Stone layer must be provided while allowing inlet to function.

Related SESC Measures:

- E & S-3 Permanent/Temporary Seeding
- E & S-29 Inlet Protection Fabric Drop
- E & S-30 Inlet Protection Geotextile and Stone

Measurement and Payment:

Payment for Inlet Protection, Sediment Trap includes furnishing and placing Geotextile Blanket.

Unless otherwise specified, Class 34R aggregate placed as shown will be included in the payment for this E & S measure.

Contract Item (Pay Item)	Pay Unit
Erosion Control, Maintenance, Sediment Removal	Cubic Yard
Erosion Control, Inlet Protection, Sediment Trap	Each

MICHIGAN DEPARTMENT OF TRANSPORTATION BUREAU OF HIGHWAY DEVELOPMENT SESC DETAIL FOR			
<h2 style="margin: 0;">Inlet Protection Sediment Trap</h2>			
 Michigan Department of Transportation	04-07-2006 PLAN DATE	E&S-31-A	SHEET 1 OF 1

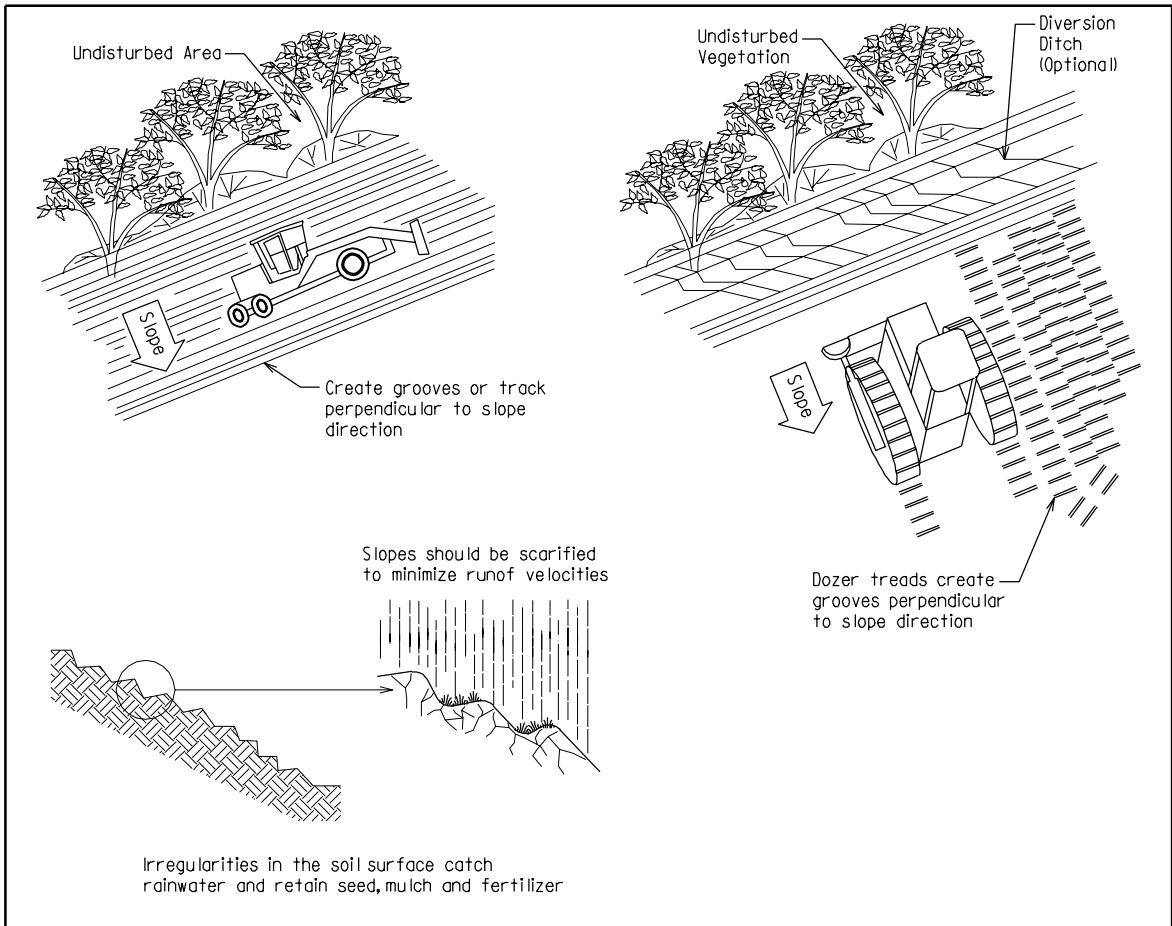

Use:

Surface Roughening and Scarification is accomplished by placing horizontal grooves in a slope perpendicular to the direction of runoff.

Installation and Maintenance:

This can be done by either disc harrowing, back blading, or running the treads of a dozer perpendicular to the slope.

Optional Measures:

A Diversion Ditch (E & S-10), Intercepting Ditch (E & S-11) and Intercepting Ditch and Diversion Dike (E & S-12) may be placed at the top of the slope to minimize the amount of runoff draining from the undisturbed area onto the new slope.

Related SESC Measures:

- E & S-3 Permanent/Temporary Seeding
- E & S-10 Diversion Dike
- E & S-11 Intercepting Ditch
- E & S-12 Intercepting Ditch and Diversion Dike
- E & S-28 Mulching and Mulch Anchoring

Measurement and Payment:

There is no separate contract item for this E & S measure. Payment for Surface Roughening and Scarification will be included in related items of work. Optional work shown, when installed and maintained as directed by the Engineer, will be paid using the associated contract item listed here.

MICHIGAN DEPARTMENT OF TRANSPORTATION
BUREAU OF HIGHWAY DEVELOPMENT SESC DETAIL FOR

Surface Roughening and Scarification



09-30-2005
PLAN DATE

E&S-32-A

SHEET
1 OF 1

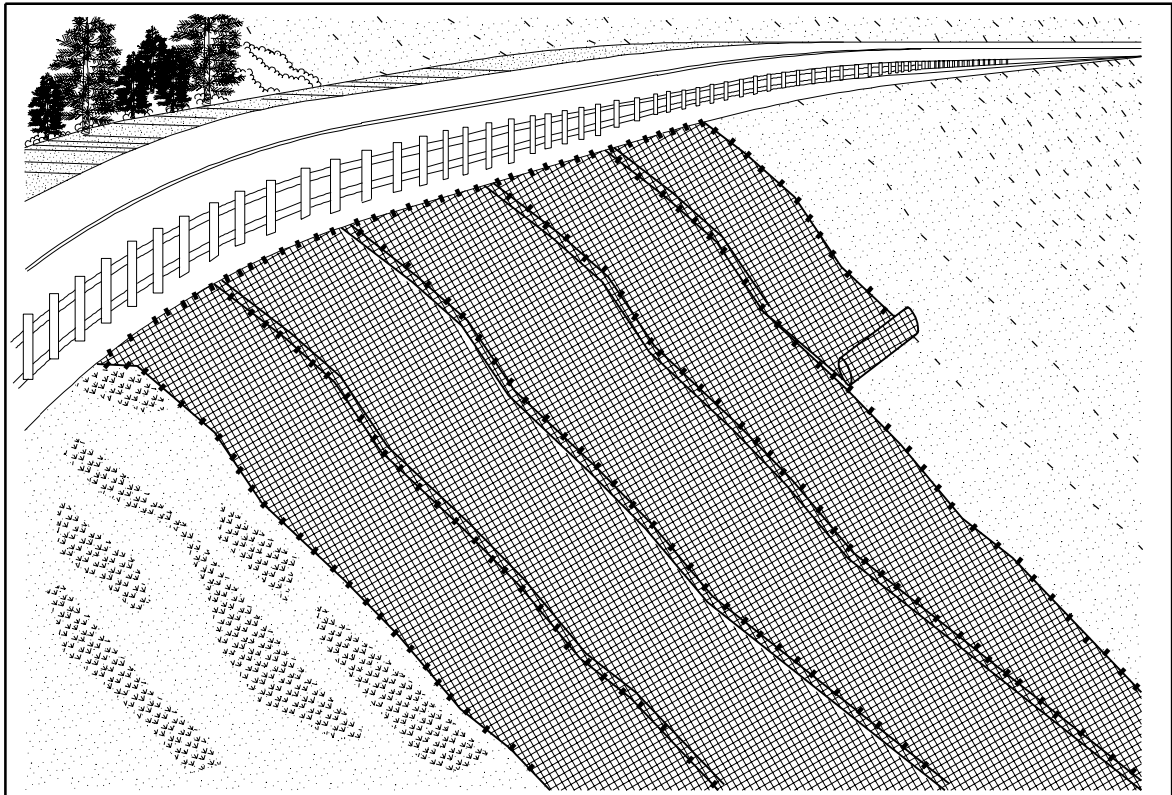

Use:

Refer to the Drainage Manual for additional design considerations when specifying this device.

Mulch Blankets and High Velocity Mulch Blankets provide an immediate and effective cover over raw erodible slopes and in ditch bottoms.

There are currently two types of mulch blankets acceptable for stabilizing slopes and ditch bottoms.

Mulch blankets have netting on one side and shall be used on slopes flatter than 1:2 along shoulders, ditch, and behind curbs. These mulch blankets shall be placed with the netting on top and the fibers in contact with the soil.

High velocity mulch blankets have netting on both sides and shall be used on 1:2 slopes or steeper and in ditch bottoms.

Installation and Maintenance:

In waterways and ditches, High Velocity Mulch Blankets shall be placed in the direction of the flow and extend 12 inches up the slope.

On backslopes, the blankets shall be placed perpendicular to the roadbed.

On foreslopes, the first strip adjacent to the road shall be laid parallel to the road. The remainder of the strips shall be placed either parallel or transverse to the road.

Install according to Standard Specifications for Construction and Standard Plan R-100 Series.

Optional Measures:

Related SESC Measures:

- E & S-3 Permanent/Temporary Seeding
- E & S-28 Mulching and Mulch Anchoring

Measurement and Payment:

Contract Item (Pay Item)	Pay Unit
Mulch Blanket	Square Yard
Mulch Blanket, High Velocity	Square Yard

MICHIGAN DEPARTMENT OF TRANSPORTATION
BUREAU OF HIGHWAY DEVELOPMENT SESC DETAIL FOR

**Mulch Blankets and High Velocity
Mulch Blankets**



04-07-2006
PLAN DATE

E&S-33-A

SHEET
1 OF 1

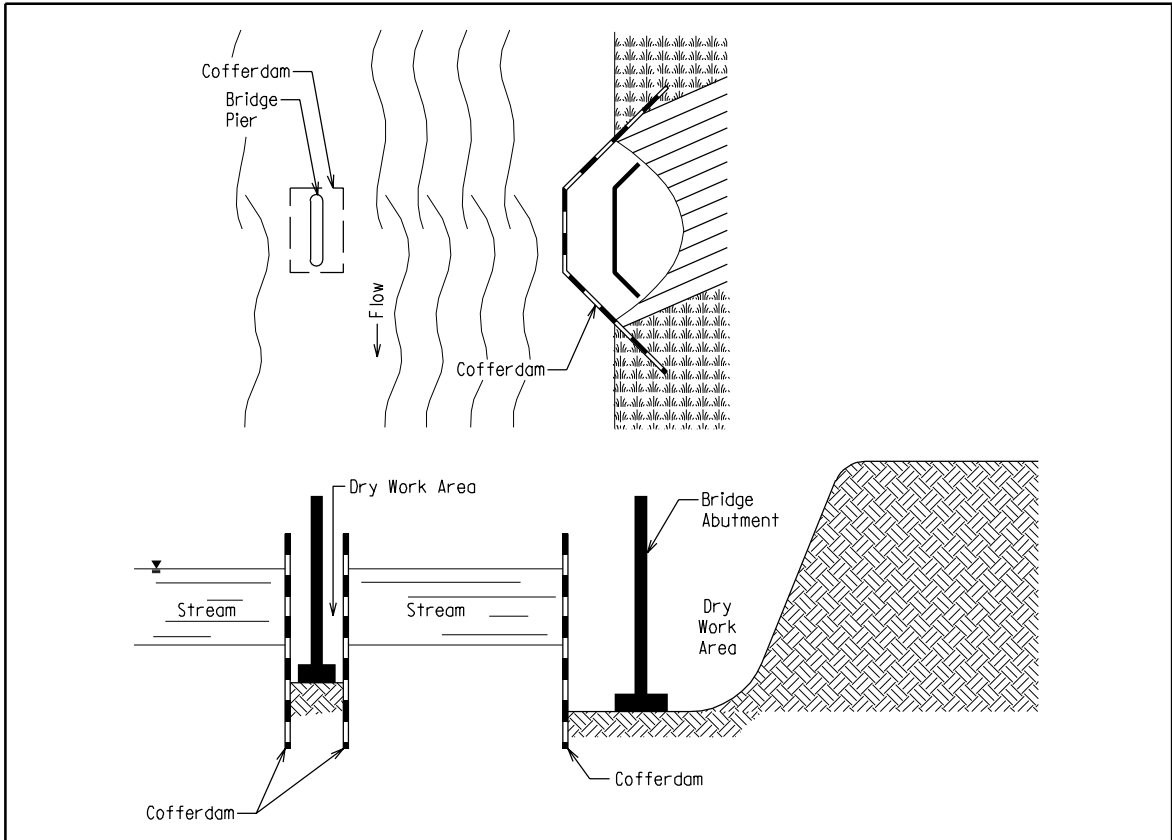

Use:

A Cofferdam is the preferred method to isolate stream flow from a construction site when a dry work condition must exist for a prolonged period of time or in a deep water condition.

A major benefit of the Cofferdam is that it results in a minimum amount of disturbance to the stream bottom during the installation and removal process.

Installation and Maintenance:

Cofferdams are generally constructed using steel sheet pile. Refer to section 704 of the Standard Specifications for Construction and the contract documents for additional information on Cofferdam design and construction.

Dewater Cofferdams in accordance with the Standard Specifications for Construction and contract documents.

Care must be taken when removing Cofferdam to prevent sedimentation to the extent practicable.

Optional Measures:

Related SESC Measures:

- E & S-7 Riprap
- E & S-13 Gravel Filter Berm
- E & S-18 Dewatering with Filter Bag
- E & S-21 Sediment Basin
- E & S-36 Construction Dam

Measurement and Payment:

Contract Item (Pay Item)	Pay Unit
Cofferdam	Lump sum
Erosion Control, Filter Bag	Each

MICHIGAN DEPARTMENT OF TRANSPORTATION BUREAU OF HIGHWAY DEVELOPMENT SESC DETAIL FOR			
Cofferdam			
	04-07-2006	E&S-34-A	SHEET 1 OF 1
	PLAN DATE		

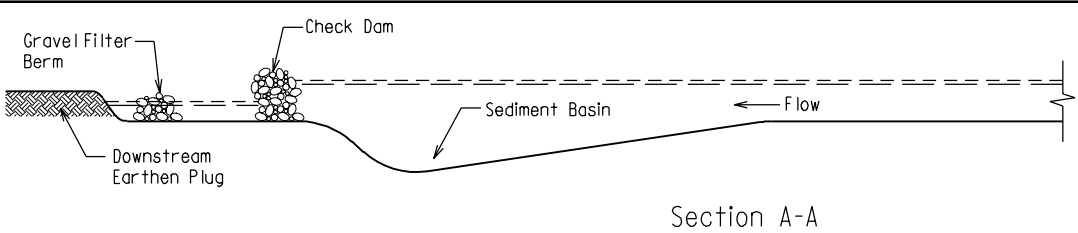

Section A-A

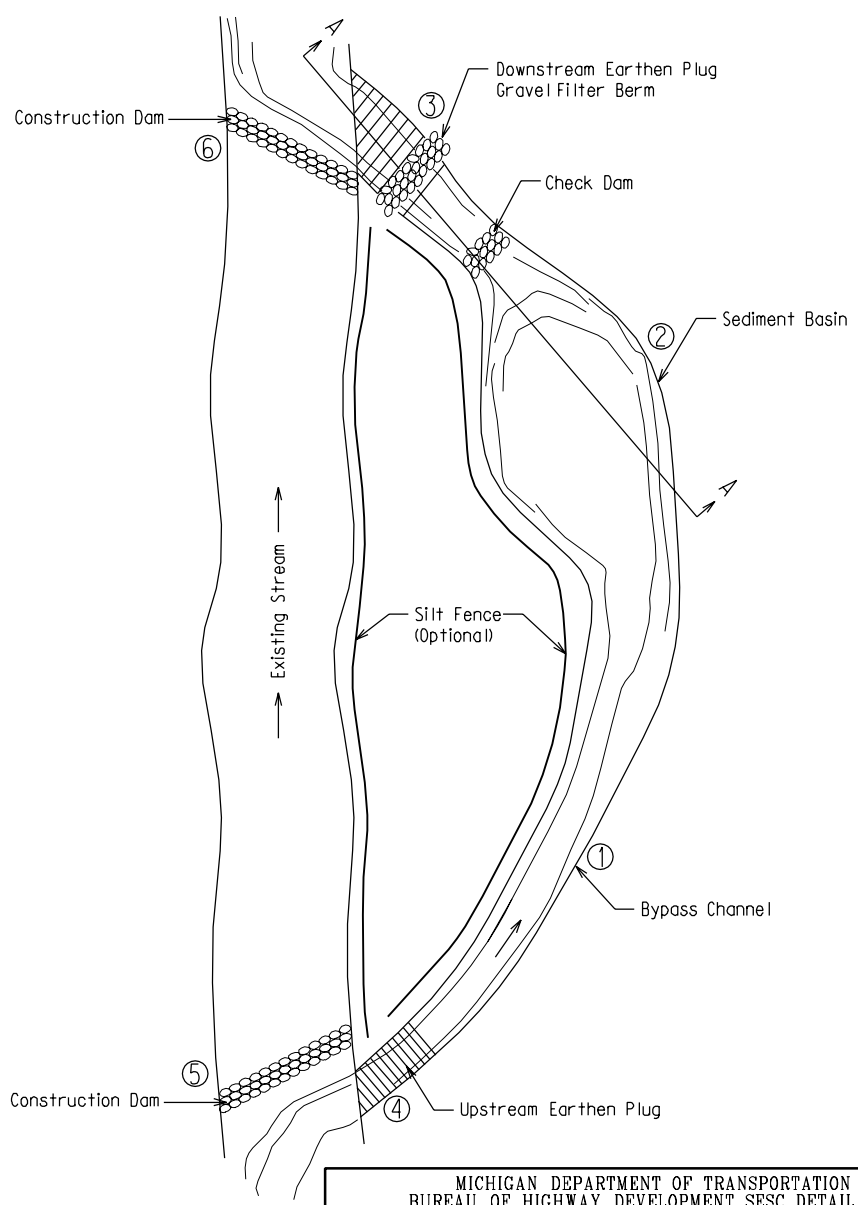

MICHIGAN DEPARTMENT OF TRANSPORTATION
BUREAU OF HIGHWAY DEVELOPMENT SESC DETAIL FOR

Temporary Bypass Channel

	09-30-2005	E&S-35-A	SHEET 1 OF 2
	PLAN DATE		

Use:

A Temporary Bypass Channel is used when a dry construction site is needed. The Temporary Bypass Channel must be properly sequenced and made an integral part of the construction plans.

This device requires consultation with the Hydraulics/Hydrology Unit of Design Support Area prior to specifying on the plans.

Refer to the Drainage Manual for additional design considerations when specifying this device.

The erosion control devices shown in this detail may be used only when included in the MDEQ permit.

Installation and Maintenance:

Example Construction Sequence and Controls:

1. Dredge Bypass Channel (1), leaving an earthen plug at the upstream (4) and downstream (3) ends.
2. Construct a large Sediment Basin (E & S-21) at the downstream limits of the Bypass Channel (2), leaving sufficient distance between the outlet of the Sediment Basin and the stream to allow placement of a Check Dam (E & S-37) and Gravel Filter Berm (E & S-13). See Section A-A. Install Check Dam and Gravel Filter Berm (E & S-13).
3. As directed by the Engineer, line the Temporary Bypass Channel with Plastic Sheets (E & S-27) with joints overlapping 18 inches in the downstream direction.
4. Remove the Downstream Plug (3) and stabilize channel from the Check Dam to the stream using Geotextile Blanket and a sturdy, non-erodible material such as Riprap (E & S-7).
5. Remove the Upstream Plug (4), allowing water to pass through the Temporary Bypass Channel.
6. Install Construction Dam (E & S-36) (5) in the existing stream at the upstream end.
7. Install Construction Dam (6) at the downstream end of the natural stream.
8. Dewater site in accordance with Dewatering with Filter Bag (E & S-18).
9. When construction is complete and all areas are stabilized, the removal process shall begin with the removal of the Construction Dam (6) at the downstream end of the natural stream.
10. Remove Construction Dam (5) at the upstream end of the natural stream. This will allow the stream flow to pass through the natural streambed.
11. Place an earthen plug at the upstream (4) and downstream (3) limits of the Temporary Bypass Channel. Stabilize earthen plug with Riprap.
12. Backfill Temporary Bypass Channel. If dewatering is necessary, reference Dewatering with Filter Bag (E & S-18).
13. Stabilize all disturbed areas.

Optional Measures:

Silt Fence may be installed adjacent to existing stream and/or Bypass channel if existing vegetation is not sufficient to prevent sediment from entering watercourse.

Related SESC Measures:

E & S-3 Permanent/Temporary Seeding	E & S-26 Silt Fence
E & S-7 Riprap	E & S-27 Plastic Sheets or Geotextile Cover
E & S-13 Gravel Filter Berm	E & S-28 Mulching and Mulch Anchoring
E & S-18 Dewatering with Filter Bag	E & S-33 Mulch Blankets and High Velocity Mulch Blankets
E & S-21 Sediment Basin	E & S-36 Construction Dam
E & S-24 Sand and Stone Bags	E & S-37 Check Dam

Measurement and Payment:

Temporary Bypass Channel, including optional work shown, when installed and maintained as directed by the Engineer, will be paid using the associated contract item listed here.

<u>Contract Item (Pay Item)</u>	<u>Pay Unit</u>
Excavation, Channel	Cubic Yard
Erosion Control, Stone Bag	Each
Erosion Control, Sand Bag	Each
Erosion Control, Sediment Basin	Cubic Yard
Erosion Control, Filter Bag	Each
Erosion Control, Check Dam, Stone	Foot
Erosion Control, Maintenance, Sediment Removal	Cubic Yard
Erosion Control, Silt Fence	Foot
Erosion Control, Temp Plastic Sheet/Geotextile Cover	Square Yard

PERMITS FROM THE MICHIGAN DEPARTMENT OF ENVIRONMENTAL QUALITY WILL BE REQUIRED.

MICHIGAN DEPARTMENT OF TRANSPORTATION
BUREAU OF HIGHWAY DEVELOPMENT SESC DETAIL FOR

Temporary Bypass Channel



04-07-2006
PLAN DATE

E&S-35-A

SHEET
2 OF 2

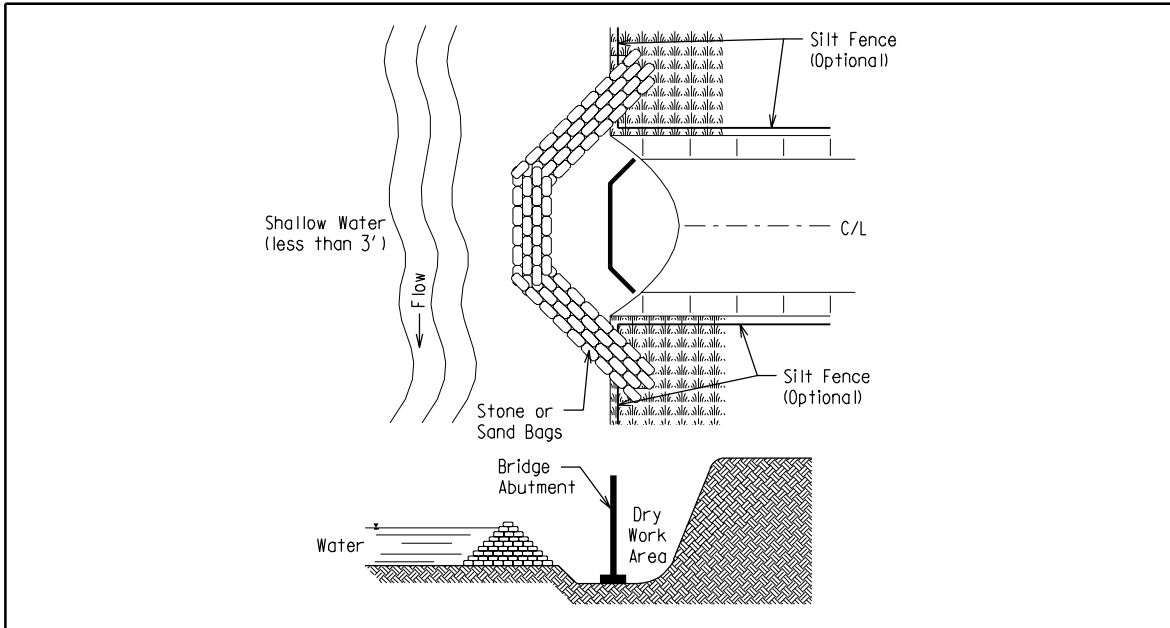

Use:

Refer to the Drainage Manual for additional design considerations when specifying this device.

A Construction Dam is used when a dry or slack water area is necessary to isolate construction activities from the watercourse.

Installation and Maintenance:

A Construction Dam can be created out of any non-erodible material. Sand or Stone Bags (E & S-24) is an effective device for a Construction Dam. Steel sheet piling, steel plates, or concrete barriers with a geotextile membrane may also be used to construct Construction Dams in lieu of sand and stone bags, if allowed by the Engineer.

Prior to the removal of the Construction Dam, remove sediment and stabilize all disturbed areas.

Care must be taken when removing Construction Dam to prevent sedimentation to the extent practicable.

Optional Measures:

If dewatering is necessary to create a dry work area, all dewatering operations may be carried out utilizing Dewatering with Filter Bag (E & S-18). Locate the filter bag a sufficient distance from the watercourse or wetland to allow for proper filtering through natural vegetation or Gravel Filter Berm (E & S-13).

Silt Fence (E & S-26) may be installed as shown to provide additional Erosion and Sedimentation Control.

All excavated or surplus soils, including filter bags, shall be disposed of in an upland area outside any floodplain or wetland areas. Excavated or surplus soils must be adequately stabilized with seed and mulch or mulch blankets in sufficient quantity to prevent erosion and subsequent sedimentation to any off-site areas, floodplains, wetlands, lakes, or streams.

Related SESC Measures:

- E & S-13 Gravel Filter Berm
- E & S-18 Dewatering with Filter Bag
- E & S-24 Sand and Stone Bags
- E & S-33 Mulch Blankets and High Velocity Mulch Blankets
- E & S-34 Cofferdam

Measurement and Payment:

Payment for Construction Dam will be included in related items of work. Optional work shown, when installed and maintained as directed by the Engineer, will be paid using the associated contract item listed here. Stabilizing exposed slopes for permanent application of this measure will be included in project quantities for similar work.

Contract Item (Pay Item)	Pay Unit
Erosion Control, Sand Bag	Each
Erosion Control, Stone Bag	Each
Erosion Control, Silt Fence	Foot

PERMITS FROM THE MICHIGAN DEPARTMENT OF ENVIRONMENTAL QUALITY WILL BE REQUIRED.

MICHIGAN DEPARTMENT OF TRANSPORTATION BUREAU OF HIGHWAY DEVELOPMENT SESC DETAIL FOR			
Construction Dam			
	04-07-2006 PLAN DATE	E&S-36-A	SHEET 1 OF 1

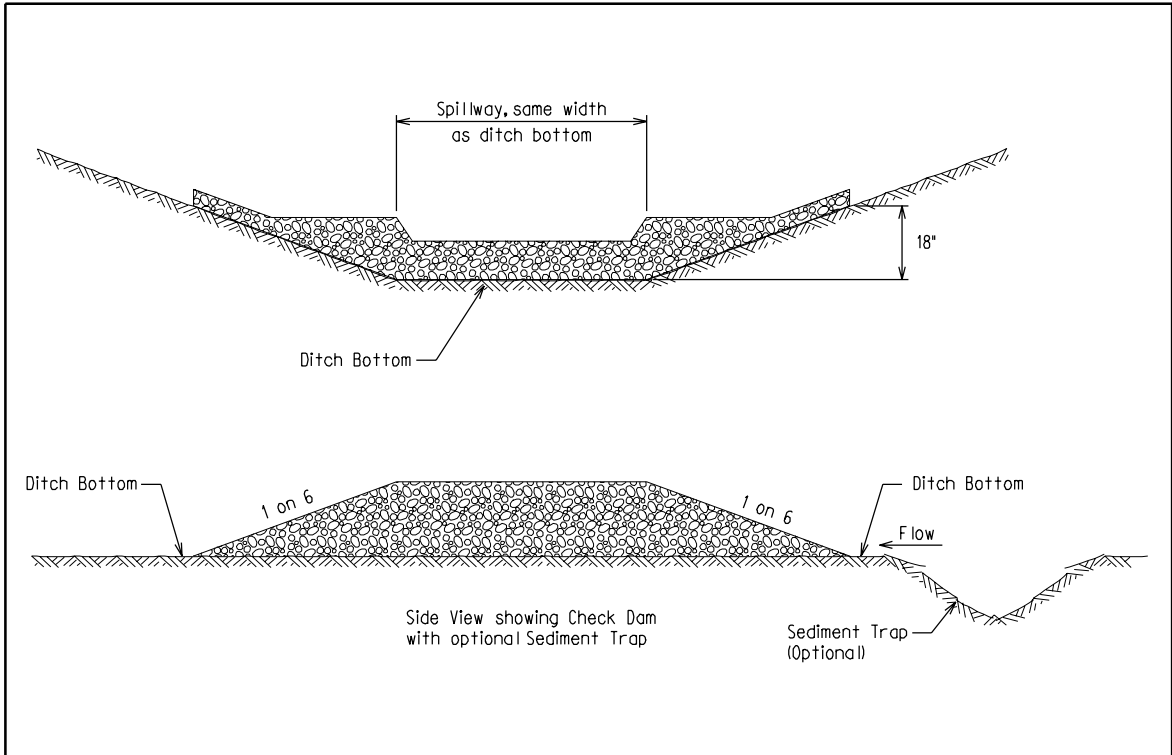

Use:

Refer to the Drainage Manual for additional design considerations when specifying this device.

Check Dams are often used in ditches to reduce flow velocity.

Check Dams are temporary and shall be completely removed after vegetation becomes established, or as directed by the Engineer.

Installation and Maintenance:

If conditions require multiple Check Dams to be placed in series, the proper spacing shall be determined based on the steepness of the ditch grade. As a general guideline, the crest elevation of the downstream Check Dam should be equal in elevation to the toe of the upstream Check Dam.

A notch should be formed in the top of the Check Dam to direct flow over the center of the dam and prevent erosion of the ditch slopes.

Stone size for Check Dam is per subsection 916.01 of the Standard Specifications for Construction.

Optional Measures:
Sediment Traps (E & S-20) may be installed directly up stream of the Check Dam to improve sediment collection.

Related SESC Measures:
E & S-7 Riprap
E & S-20 Sediment Trap

Measurement and Payment:
Optional work shown, when installed and maintained as directed by the Engineer, will be paid using the associated contract item listed here.

Contract Item (Pay Item)	Pay Unit
Erosion Control, Check Dam, Stone	Foot
Erosion Control, Sediment Trap	Each
Erosion Control, Maintenance, Sediment Removal	Cubic Yard

MICHIGAN DEPARTMENT OF TRANSPORTATION
BUREAU OF HIGHWAY DEVELOPMENT SESC DETAIL FOR

Check Dam

	04-07-2006	E&S-37-A	SHEET 1 OF 1
	PLAN DATE		

APPENDIX
REFERENCE INFORMATION

THIS PAGE BLANK

Activity Name: Ditch Clean-Out		Activity #: 12300																																					
Description/Purpose: Roadside ditch clean-out includes the removal and disposal of debris to ensure proper drainage																																							
<p align="center"><u>Recommended Crew Size</u> 5 (2 traffic regulators included)</p> <p align="center"><u>Material</u> As required for soil erosion procedures and/or sedimentation control</p> <p align="center"><u>Average Daily Production</u> 400-800 lineal feet (excavator) 300-500 lineal feet (tractor/backhoe) 400-800 lineal feet (grader/dozer)</p>	<table border="1"> <thead> <tr> <th><u>Qty</u></th> <th><u>Code</u></th> <th><u>Equipment Description</u></th> </tr> </thead> <tbody> <tr> <td>1</td> <td>02/03</td> <td>Pickup</td> </tr> <tr> <td>3</td> <td>04</td> <td>Trucks (see Table below)</td> </tr> <tr> <td>1</td> <td>12</td> <td>Flashing arrow</td> </tr> <tr> <td>1</td> <td>26</td> <td>Gradall (if available) or</td> </tr> <tr> <td>1</td> <td>05</td> <td>Tractor/backhoe/extendahoe (alternate)</td> </tr> <tr> <td colspan="3"><u>Optional</u></td> </tr> <tr> <td>1</td> <td>32</td> <td>Grader</td> </tr> <tr> <td>1</td> <td>05</td> <td>Bulldozer</td> </tr> <tr> <td>1</td> <td>12</td> <td>Flashing Arrow</td> </tr> <tr> <td>1</td> <td>38</td> <td>Loader</td> </tr> <tr> <td>1</td> <td>67</td> <td>Trailer</td> </tr> </tbody> </table>	<u>Qty</u>	<u>Code</u>	<u>Equipment Description</u>	1	02/03	Pickup	3	04	Trucks (see Table below)	1	12	Flashing arrow	1	26	Gradall (if available) or	1	05	Tractor/backhoe/extendahoe (alternate)	<u>Optional</u>			1	32	Grader	1	05	Bulldozer	1	12	Flashing Arrow	1	38	Loader	1	67	Trailer		
<u>Qty</u>	<u>Code</u>	<u>Equipment Description</u>																																					
1	02/03	Pickup																																					
3	04	Trucks (see Table below)																																					
1	12	Flashing arrow																																					
1	26	Gradall (if available) or																																					
1	05	Tractor/backhoe/extendahoe (alternate)																																					
<u>Optional</u>																																							
1	32	Grader																																					
1	05	Bulldozer																																					
1	12	Flashing Arrow																																					
1	38	Loader																																					
1	67	Trailer																																					
<u>Recommended Work Method</u>																																							
<p>Caution : Check with utility companies for buried gas lines, telephone or electric cables, etc. Call MISS DIG</p> <p>Contact your resource staff or appointed region representative if questions arise regarding storm water or soil erosion control and to determine if any permits are required. (Act 451, specifically, disturbing land area of one acre or more or within 500 feet of a lake or stream.) NOTE: When performing this operation, follow the procedure in the appendix of the Soil Erosion and Sedimentation Control (SESC) Manual.</p> <p>Complete <u>MDOT forms</u> 1126 (National Pollutant Discharge Elimination System Inspection Report) and 0408 (Work Schedule) when performing this operation.</p> <ol style="list-style-type: none"> 1. Review <u>environmental training and safety precautions</u>. 2. Establish the ditch flow line (use appropriate measuring device). 3. Determine the location the water will outlet to. 4. If spoils will be taken off-site, provide a dump site for the spoils to be removed to. (i.e. use spoils to flatten slopes behind guardrails that will be removed in the future.) 5. If spoils are left on site, remove all debris, grade properly, and prepare spoils for seeding. 6. Remove spoils and load into trucks with minimum interference with traffic. 7. Avoid creating a "V" bottom ditch; a 2-foot round-bottom ditch is the minimum requirement. 3 feet or wider ditches are desirable for drainage and snow storage. 8. As required, dress, mulch, seed and/or sod slopes to prevent erosion. See sections 816 and 917 of the standard specifications. 																																							
Equipment Requirements																																							
Crew Size	Round Trip Distance Stockpile to Dumpsite	Number of 04 Trucks Needed																																					
4	0-5 miles	2																																					
5	6- 10 miles	3																																					
6	11-15 miles	4																																					

DITCH CLEAN OUT (Activity #12300)

1. Notifications: If the operation disturbs more than one acre of earth and is to restore the ditch to original ditch grades (match inlet and outlet grades) a National Pollutant Discharge Elimination System (NPDES) Notice of Coverage (NOC) is not required. If the project disturbs five acres or more of earth and is to alter the original ditch grade (new outlet or inlet grade) an NOC and notification of the municipal enforcing agency (MEA) or county enforcing agency (CEA) is required.

2. Inspections: For earth disturbances greater than one acre, a certified storm water operator (SWO) will inspect the project once per week and within 24-hours after each precipitation event, that results in a discharge from the right-of-way. NPDES Inspection Report (Form 1126) will be used to document these inspections. Any deficiencies or corrective actions will be recorded on the form and will be brought to the attention of the Contractor or maintenance staff performing the work. The SWO is responsible for ensuring that corrective actions are completed within the time allotted. A log of the inspections will be maintained on file for review and retained for a period of three years from the date of the inspection or the date corrective actions were complete, whichever is longer.

Non-emergency corrective actions will be completed by those doing the ditch clean out, or by others if necessary, within five calendar days. If the Maintenance Coordinator determines that an emergency condition exists, corrective actions will be completed by those doing the work within 24 hours of the inspection. Emergency conditions include sediment entering drainage structures or the waters of the state and erosion that affects the support of the roadbed or the safety of the public. Emergency action will be documented as such on Form 1126.

3. SESC Plan: The following soil erosion and sedimentation control (SESC) procedure has been reviewed by MDEQ and is approved for this activity. This procedure is intended to minimize soil erosion and off right-of-way sedimentation during ditch clean out activities. If this procedure is not followed, a site-specific SESC plan meeting the requirements of rule R323.1703, promulgated in accordance with Part 91 of Act 451, is required.

If spoils are taken to an off right-of-way location, the Standard Specifications for Construction controls the disposal of the surplus material. The property owner or easement holder where the material is to be placed must obtain a SESC permit from the appropriate enforcing agency if the placement covers one acre or more or if the material is placed within 500 feet of the waters of the state. If excess materials will be transported off the right-of-way for disposal, notify the maintenance coordinator or region resource staff prior to beginning the ditch clean out operation and request that they contact the enforcing agency to determine if a permit is required. If a permit is required, the permit must be obtained prior to beginning this work.

- If the ditch slope is one percent or more, install sediment traps (E&S-20) in the ditch bottom, spaced approximately 300 feet apart (\pm 50 feet).
- Maintain a vegetative buffer (E&S-6) between the lower limit of the ditch clean out operation and the outfall to the watercourse. If the vegetative buffer cannot be left in place while the disturbed area upstream stabilizes, place high velocity mulch blanket (E&S-33) on the ditch bottom a minimum of 150 feet upstream from the lower limit of the ditch clean out operation.
- If the ditch carries water continuously, install a check dam (E&S-37) and sediment trap (E&S - 20) at the downstream end of the ditch.
- Begin ditching operation at the highest elevation and progress downstream.
- Remove the vegetative buffer only after the disturbed area has been stabilized. After removing the vegetative buffer, stabilize that area with high velocity mulch blanket.
- Within five days of completing the work, seed and mulch (E&S-3) all exposed areas resulting from the ditch cleanout activities. If the work is completed outside of the seasonal limitations for seeding, place high velocity mulch blanket over the entire disturbed area. Contact appropriate region resource staff for alternative restoration recommendations.

Sample NPDES/SESC Inspection Report (Form 1126)



Michigan Department
of Transportation
1126 (10/05)

NATIONAL POLLUTANT DISCHARGE ELIMINATION SYSTEM (NPDES) AND SOIL EROSION AND SEDIMENTATION CONTROL (SESC)

Page 1 of 2

INSPECTION REPORT

FILE 108

Completed form to
Project Files ONLY.

CONTROL SECTION 00001	JOB NUMBER 12345A	ROUTE M-300	REPORT NUMBER 6	DATE 06-08-06
RESIDENT/DELIVERY ENGINEER OR MAINTENANCE COORDINATOR N. Charge		SESC CERTIFICATE NO. #001122	NPDES CERTIFIED STORM WATER OPERATOR NO. #123456	
INSPECTOR NAME (Please print) I. M. Certified		INSPECTOR (Signature) sign copy in project file		
AMOUNT, TYPE & DATE OF LAST PRECIPITATION Trace of rain 06-06-06			DATE OF LAST INSPECTION 06-01-06	

CONTRACTOR
Dirt Movers, Inc.

LOCATION/ STATION	TYPE OF CONTROL	INSTALLATION DATE	CORRECTIVE ACTION REQUIRED (See Note 3)	NOTIFICATION DATE	COMPLETION DATE
Sta. 102+50 Rt	Silt fence @ wetland	05-20-06	None Good Condition		
Sta 103+25 Rt	Silt fence @ wetland	05-20-06	None Good Condition		
M-300 @ Adams	Inlet protection NE Quadrant	05-20-06	None Good Condition		
M-300 @ Adams	Inlet protection NE Quadrant	05-20-06	Needs replacement	06-08-06	06-09-06
M-300 @ Adams	Inlet protection NE Quadrant	05-20-06	None Good Condition		
M-300 @ Adams	Inlet protection NE Quadrant	05-20-06	Remove Sediment / Replace	06-08-06	06-09-06

REMARKS

Inlets at Adams St discharge to wetland - 24 hour corrective action required - Follow up on 6-09-06 to confirm

Remainder of project SESC measures are in good condition

Silt fence at wetland installed properly and maintained

NOTES *SKETCHES ON BACK AS NEEDED*

1. Inspectors must have valid certification for both SESC and NPDES.
2. Site shall be inspected every seven days and within 24 hours after every precipitation event resulting in discharge from the right of way.
3. Corrective action shall be made within 24 hours if sedimentation has occurred into a watercourse or public safety may be compromised. Otherwise corrective action shall be made within 5 calendar days.

SKETCHES



REMARKS

CONTROL SECTION 00001	JOB NUMBER 12345A	ROUTE M-300	REPORT NUMBER 6	DATE 06-08-06
RESIDENT/DELIVERY ENGINEER OR MAINTENANCE COORDINATOR N. Charge		SESC CERTIFICATE NO. 001122	NPDES CERTIFIED STORM WATER OPERATOR NO. 123456	
INSPECTOR NAME (Please print) I. M. Certified		INSPECTOR (Signature) signed copy in project file		

SAMPLE SESC Plan (Rule 1703)

(may be hand drawn)

Example: Placement of a concrete plant between Ramp C slope stake line and Ramp C right of way

Soils: Sandy loam  Gradient: 0.6%  **XXXXXX** Limits of earth change covered by this Plan 

Notes:

1. Install SESC measures prior to grading the site.
2. Strip sod and topsoil and stockpile as directed by the engineer.
3. Grade and spread gravel base on the site.
4. When project is complete:
 - a. Remove concrete plant, gravel base, and gravel access approach.
 - b. Spread topsoil.
 - c. Seed and mulch at 3 tons per acre between November 15 and before the ground freezes.
5. Silt fence shall not be removed until vegetation is well established.
6. Nearest lake or stream is 3/4 mile south of site.

 Start: May 15, 2005
 Finish: October 20, 2005

Erosion Control Measures:



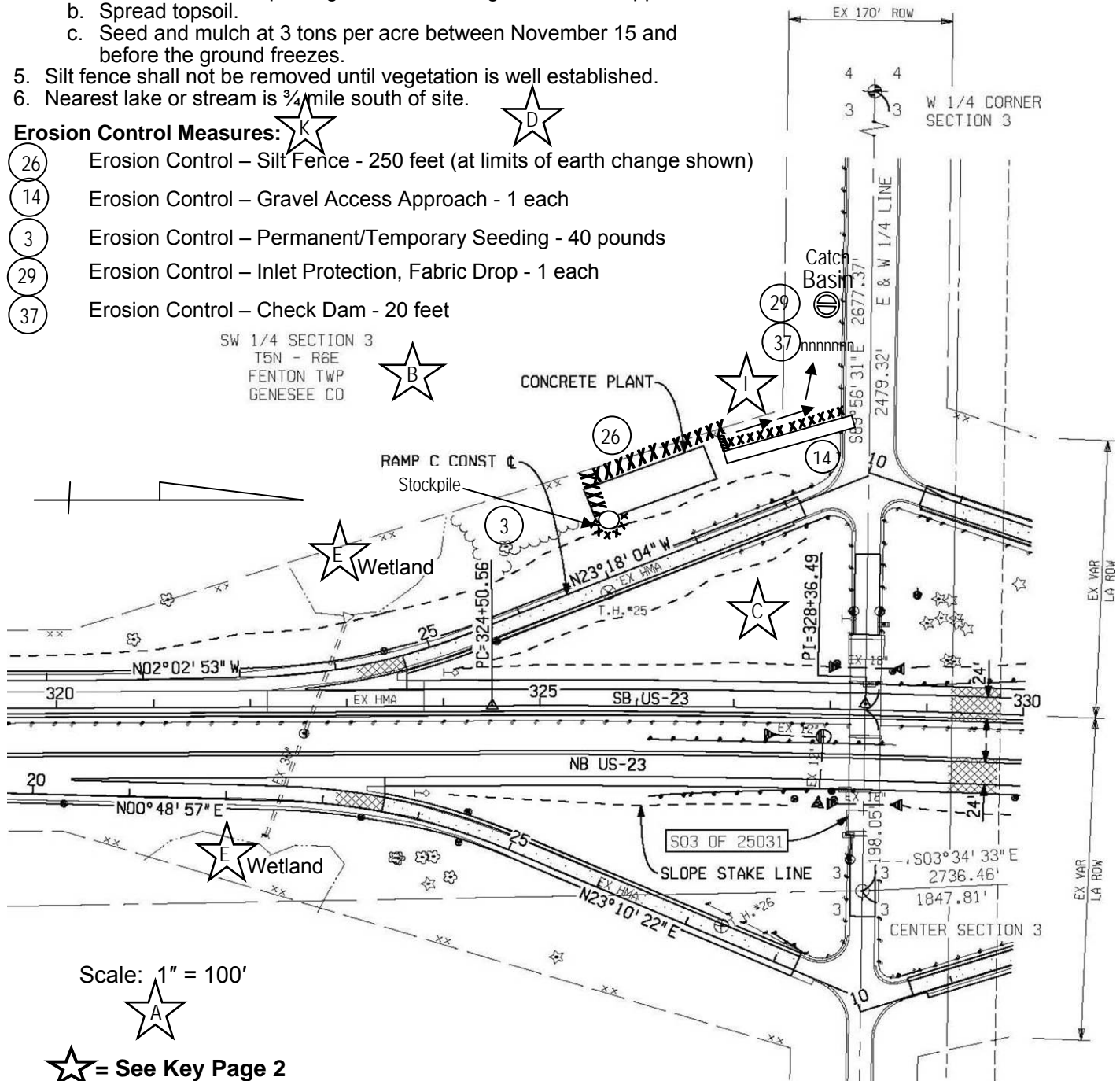









-  Erosion Control – Silt Fence - 250 feet (at limits of earth change shown)
-  Erosion Control – Gravel Access Approach - 1 each
-  Erosion Control – Permanent/Temporary Seeding - 40 pounds
-  Erosion Control – Inlet Protection, Fabric Drop - 1 each
-  Erosion Control – Check Dam - 20 feet



Scale: 1" = 100'

 = See Key Page 2

Key to SESC Plan Components

-  Scaled drawing.
-  Legal description.
-  Site location sketch.
-  Proximity to lakes and streams.
-  Predominant land features.
-  Contour intervals or slope descriptions.
-  Description of soil types.
-  Physical limits of the earth change.
-  Drainage and dewatering facilities.
-  Timing and sequence of earth change.
-  Description and location of control measures.
-  Maintenance plan (temporary and permanent).

