

# CONSTRUCTION REQUEST FOR PROPOSAL

**RFP# 22-82**

## **S. Main Street Water Main Replacement and Resurfacing Project**

City of Ann Arbor  
Public Services / Engineering Unit



**Due Date: December 20, 2022 by 10:00 a.m. (local time)**

Issued By:

City of Ann Arbor  
Procurement Unit  
301 E. Huron Street  
Ann Arbor, MI 48104

**TABLE OF CONTENTS**

SECTION I: GENERAL INFORMATION .....3

SECTION II: SCOPE OF WORK..... 11

SECTION III: MINIMUM INFORMATION REQUIRED ..... 12

SECTION IV: ATTACHMENTS ..... 24

## **SECTION I - GENERAL INFORMATION**

### **A. OBJECTIVE**

The purpose of this Request for Proposal (RFP) is to select a firm to provide the construction of S. Main Street Water Main Replacement and Resurfacing Project as described in the plans and specifications.

### **B. QUESTIONS AND CLARIFICATIONS / DESIGNATED CITY CONTACTS**

All questions regarding this Request for Proposal (RFP) shall be submitted via e-mail. Questions will be accepted and answered in accordance with the terms and conditions of this RFP.

**All questions shall be submitted on or before December 1, 2022 at 5:00 p.m. (local time)**, and should be addressed as follows:

Scope of Work/Proposal Content questions shall be e-mailed to **Christopher Wall, PE, [cwall@a2gov.org](mailto:cwall@a2gov.org)**

RFP Process and Compliance questions shall be e-mailed to Colin Spencer, Buyer - [CSpencer@a2gov.org](mailto:CSpencer@a2gov.org)

Should any prospective bidder be in doubt as to the true meaning of any portion of this RFP, or should the prospective bidder find any ambiguity, inconsistency, or omission therein, the prospective bidder shall make a written request for an official interpretation or correction by the due date for questions above.

All interpretations, corrections, or additions to this RFP will be made only as an official addendum that will be posted to [a2gov.org](http://a2gov.org) and [MITN.info](http://MITN.info) and it shall be the prospective bidder's responsibility to ensure they have received all addenda before submitting a proposal. Any addendum issued by the City shall become part of the RFP, and must be incorporated in the proposal where applicable.

### **C. PRE-PROPOSAL MEETING**

A pre-proposal conference for this project will be held on December 1, 2022 at 2:00 p.m. virtually via Microsoft Teams. If you would like to attend the Microsoft Teams pre-proposal meeting, please email [cwall@a2gov.org](mailto:cwall@a2gov.org) to request a meeting invite by 5:00 p.m. on November 30, 2022.

Attendance at this conference is highly recommended. Administrative and technical questions regarding this project will be answered at this time. The pre-proposal conference is for information only. Any answers furnished will not be official until verified in writing by the Financial Service Area, Procurement Unit. Answers that change or substantially clarify the proposal will be affirmed in an addendum.

#### **D. PROPOSAL FORMAT**

To be considered, each firm must submit a response to this RFP using the format provided in Section III. No other distribution of proposals is to be made by the prospective bidder. An official authorized to bind the bidder to its provisions must sign the proposal. Each proposal must remain valid for at least one hundred and twenty (120) days from the due date of this RFP.

Proposals should be prepared simply and economically providing a straightforward, concise description of the bidder's ability to meet the requirements of the RFP. No erasures are permitted. Mistakes may be crossed out and corrected and must be initialed in ink by the person signing the proposal.

#### **E. SELECTION CRITERIA**

Responses to this RFP will be evaluated using a point system as shown in Section III. A selection committee comprised primarily of staff from the City will complete the evaluation.

If interviews are desired by the City, the selected firms will be given the opportunity to discuss their proposal, qualifications, past experience, and their fee proposal in more detail. The City further reserves the right to interview the key personnel assigned by the selected bidder to this project.

All proposals submitted may be subject to clarifications and further negotiation. All agreements resulting from negotiations that differ from what is represented within the RFP or in the proposal response shall be documented and included as part of the final contract.

#### **F. SEALED PROPOSAL SUBMISSION**

**All proposals are due and must be delivered to the City on or before December 20, 2022 by 10:00a.m. (local time).** Proposals submitted late or via oral, telephonic, telegraphic, electronic mail or facsimile **will not** be considered or accepted.

**Each respondent should submit in a sealed envelope**

- **one (1) original proposal**
- **one (1) additional proposal copy**
- **one (1) digital copy of the proposal preferably on a USB/flash drive as one file in PDF format**



Proposals submitted should be clearly marked: **RFP No. 22-82 – S. Main Street Water Main Replacement and Resurfacing Project** and list the bidder's name and address.

Proposals must be addressed and delivered to:  
City of Ann Arbor  
c/o Customer Service  
301 East Huron Street  
Ann Arbor, MI 48107

All proposals received on or before the due date will be publicly opened and recorded on the due date. No immediate decisions will be rendered.

Hand delivered proposals may be dropped off in the Purchasing drop box located in the Ann Street (north) vestibule/entrance of City Hall which is open to the public Monday through Friday from 8am to 5pm (except holidays). The City will not be liable to any prospective bidder for any unforeseen circumstances, delivery, or postal delays. Postmarking on the due date will not substitute for receipt of the proposal.

Bidders are responsible for submission of their proposal. Additional time will not be granted to a single prospective bidder. However, additional time may be granted to all prospective bidders at the discretion of the City.

**A proposal may be disqualified if the following required forms are not included with the proposal:**

- **Attachment D - Prevailing Wage Declaration of Compliance**
- **Attachment E - Living Wage Declaration of Compliance**
- **Attachment G - Vendor Conflict of Interest Disclosure Form**
- **Attachment H - Non-Discrimination Declaration of Compliance**

***Proposals that fail to provide these forms listed above upon proposal opening may be deemed non-responsive and may not be considered for award.***

## **G. DISCLOSURES**

Under the Freedom of Information Act (Public Act 442), the City is obligated to permit review of its files, if requested by others. All information in a proposal is subject to disclosure under this provision. This act also provides for a complete disclosure of contracts and attachments thereto.

## **H. TYPE OF CONTRACT**

A sample of the Construction Agreement is included as Attachment A. Those who wish to submit a proposal to the City are required to review this sample agreement carefully. **The City will not entertain changes to its Construction Agreement.**

For all construction work, the respondent must further adhere to the City of Ann Arbor General Conditions. The General Conditions are included herein. Retainage will be held as necessary based on individual tasks and not on the total contract value. The Contractor shall provide the required bonds included in the Contract Documents for the duration of the Contract.

The City reserves the right to award the total proposal, to reject any or all proposals in whole or in part, and to waive any informality or technical defects if, in the City's sole judgment, the best interests of the City will be so served.

This RFP and the selected bidder's response thereto, shall constitute the basis of the scope of services in the contract by reference.

## **I. NONDISCRIMINATION**

All bidders proposing to do business with the City shall satisfy the contract compliance administrative policy adopted by the City Administrator in accordance with the Section 9:158 of the Ann Arbor City Code. Breach of the obligation not to discriminate as outlined in Attachment G shall be a material breach of the contract. Contractors are required to post a copy of Ann Arbor's Non-Discrimination Ordinance attached at all work locations where its employees provide services under a contract with the City.

## **J. WAGE REQUIREMENTS**

The Attachments provided herein outline the requirements for payment of prevailing wages or of a "living wage" to employees providing service to the City under this contract. The successful bidder must comply with all applicable requirements and provide documentary proof of compliance when requested.

Pursuant to Resolution R-16-469 all public improvement contractors are subject to prevailing wage and will be required to provide to the City payroll records sufficient to demonstrate compliance with the prevailing wage requirements. Use of Michigan Department of Transportation Prevailing Wage Forms (sample attached hereto) or a City-approved equivalent will be required along with wage rate interviews.

For laborers whose wage level are subject to federal, state and/or local prevailing wage law the appropriate Davis-Bacon wage rate classification is identified based upon the work including within this contract. **The wage determination(s) current on the date 10 days before proposals are due shall apply to this contract.** The U.S. Department of Labor (DOL) has provided explanations to assist with classification in the following resource link: [www.wdol.gov](http://www.wdol.gov).

For the purposes of this RFP the Construction Type of Highway will apply.

#### **K. CONFLICT OF INTEREST DISCLOSURE**

The City of Ann Arbor Purchasing Policy requires that the consultant complete a Conflict of Interest Disclosure form. A contract may not be awarded to the selected bidder unless and until the Procurement Unit and the City Administrator have reviewed the Disclosure form and determined that no conflict exists under applicable federal, state, or local law or administrative regulation. Not every relationship or situation disclosed on the Disclosure Form may be a disqualifying conflict. Depending on applicable law and regulations, some contracts may awarded on the recommendation of the City Administrator after full disclosure, where such action is allowed by law, if demonstrated competitive pricing exists and/or it is determined the award is in the best interest of the City. A copy of the Conflict of Interest Disclosure Form is attached.

#### **L. COST LIABILITY**

The City of Ann Arbor assumes no responsibility or liability for costs incurred by the bidder prior to the execution of an Agreement. The liability of the City is limited to the terms and conditions outlined in the Agreement. By submitting a proposal, bidder agrees to bear all costs incurred or related to the preparation, submission, and selection process for the proposal.

#### **M. DEBARMENT**

Submission of a proposal in response to this RFP is certification that the Respondent is not currently debarred, suspended, proposed for debarment, and declared ineligible or voluntarily excluded from participation in this transaction by any State or Federal departments or agency. Submission is also agreement that the City will be notified of any changes in this status.

#### **N. PROPOSAL PROTEST**

All proposal protests must be in writing and filed with the Purchasing Manager within five (5) business days of the award action. The bidder must clearly state the reasons for the protest. If any bidder contacts a City Service Area/Unit and indicates a desire to protest an award, the Service Area/Unit shall refer the bidder to the Purchasing Manager. The Purchasing Manager will provide the bidder with the appropriate instructions for filing the protest. The protest shall be reviewed by the City Administrator or designee, whose decision shall be final.

Any inquiries or requests regarding this procurement should be only submitted in writing to the Designated City Contacts provided herein. Attempts by the bidder to initiate contact with anyone other than the Designated City Contacts provided herein that the bidder believes can influence the procurement decision, e.g., Elected Officials,

City Administrator, Selection Committee Members, Appointed Committee Members, etc., may lead to immediate elimination from further consideration.

## **O. SCHEDULE**

The following is the schedule for this RFP process.

<b>Activity/Event</b>	<b>Anticipated Date</b>
Pre-Proposal Meeting	Dec. 1, 2022, 2:00 p.m.(Local Time)
Written Question Deadline	Dec. 1, 2022, 5:00 p.m.(Local Time)
Addenda Published (if needed)	Week of December 5, 2022
Proposal Due Date	Dec. 20, 2022, 10:00 a.m. (Local Time)
Selection/Negotiations	December 2022
Expected City Council Authorizations	February 2023

The above schedule is for information purposes only and is subject to change at the City's discretion.

## **P. IRS FORM W-9**

The selected bidder will be required to provide the City of Ann Arbor an IRS form W-9.

## **Q. RESERVATION OF RIGHTS**

1. The City reserves the right in its sole and absolute discretion to accept or reject any or all proposals, or alternative proposals, in whole or in part, with or without cause.
2. The City reserves the right to waive, or not waive, informalities or irregularities in terms or conditions of any proposal if determined by the City to be in its best interest.
3. The City reserves the right to request additional information from any or all bidders.
4. The City reserves the right to reject any proposal that it determines to be unresponsive and deficient in any of the information requested within RFP.
5. The City reserves the right to determine whether the scope of the project will be entirely as described in the RFP, a portion of the scope, or a revised scope be implemented.
6. The City reserves the right to select one or more contractors or service providers to perform services.
7. The City reserves the right to retain all proposals submitted and to use any ideas in a proposal regardless of whether that proposal is selected. Submission of a proposal indicates acceptance by the firm of the conditions contained in this RFP, unless clearly and specifically noted in the proposal submitted.
8. The City reserves the right to disqualify proposals that fail to respond to any requirements outlined in the RFP, or failure to enclose copies of the required documents outlined within the RFP.

## **R. IDLEFREE ORDINANCE**

The City of Ann Arbor adopted an idling reduction Ordinance that went into effect July 1, 2017. The full text of the ordinance (including exemptions) can be found at: [www.a2gov.org/idlefree](http://www.a2gov.org/idlefree).

Under the ordinance, No Operator of a Commercial Vehicle shall cause or permit the Commercial Vehicle to Idle:

- (a) For any period of time while the Commercial Vehicle is unoccupied; or
- (b) For more than 5 minutes in any 60-minute period while the Commercial Vehicle is occupied.

In addition, generators and other internal combustion engines are covered

- (1) Excluding Motor Vehicle engines, no internal combustion engine shall be operated except when it is providing power or electrical energy to equipment or a tool that is actively in use.

## **S. ENVIRONMENTAL COMMITMENT**

The City of Ann Arbor recognizes its responsibility to minimize negative impacts on human health and the environment while supporting a vibrant community and economy. The City further recognizes that the products and services the City buys have inherent environmental and economic impacts and that the City should make procurement decisions that embody, promote, and encourage the City's commitment to the environment.

The City encourages potential vendors to bring forward emerging and progressive products and services that are best suited to the City's environmental principles.

## **T. BID SECURITY**

Each bid must be accompanied by a certified check, or Bid Bond by a surety licensed and authorized to do business within the State of Michigan, in the amount of 5% of the total of the bid price.

## **U. MAJOR SUBCONTRACTORS**

The Bidder shall identify each major subcontractor it expects to engage for this Contract if the work to be subcontracted is 15% or more of the bid sum or over \$50,000, whichever is less. The Bidder also shall identify the work to be subcontracted to each major subcontractor. The Bidder shall not change or replace a subcontractor without approval by the City.

## **V. LIQUIDATED DAMAGES**

A liquidated damages clause, as given on page C-2, Article III of the Contract, provides that the Contractor shall pay the City as liquidated damages, and not as a penalty, a sum certain per day for each and every day that the Contractor may be in default of completion of the specified work, within the time(s) stated in the Contract, or written extensions.

Liquidated damages clauses, as given in the General Conditions, provide further that the City shall be entitled to impose and recover liquidated damages for breach of the obligations under Chapter 112 of the City Code.

The liquidated damages are for the non-quantifiable aspects of any of the previously identified events and do not cover actual damages that can be shown or quantified nor are they intended to preclude recovery of actual damages in addition to the recovery of liquidated damages.

## **SECTION II - SCOPE OF WORK**

**Please see the plan set and specifications for more details.**

## **SECTION III - MINIMUM INFORMATION REQUIRED**

### **PROPOSAL FORMAT**

The following describes the elements that should be included in each of the proposal sections and the weighted point system that will be used for evaluation of the proposals.

Bidders should organize Proposals into the following Sections:

- A. Qualifications, Experience and Accountability
- B. Workplace Safety
- C. Workforce Development
- D. Social Equity and Sustainability
- E. Schedule of Pricing/Cost
- F. Authorized Negotiator
- G. Attachments

*Bidders are strongly encouraged to provide details for all of the information requested below within initial proposals. Backup documentation may be requested at the sole discretion of the City to validate all of the responses provided herein by bidders. False statements by bidders to any of the criteria provided herein will result in the proposal being considered non-responsive and will not be considered for award.*

Pursuant to Sec 1:314(9) of the City Code which sets forth requirements for evaluating construction bids, Bidders should submit the following:

#### **A. Qualifications, Experience and Accountability - 20 Points**

1. Qualifications and experience of the bidder and of key persons, management, and supervisory personnel to be assigned by the bidder.
2. References from individuals or entities the bidder has worked for within the last five (5) years including information regarding records of performance and job site cooperation.
3. Evidence of any quality assurance program used by the bidder and the results of any such program on the bidder's previous projects.
4. A statement from the bidder as to any major subcontractors it expects to engage including the name, work, and amount.



**B. Workplace Safety – 20 Points**

1. Documentation of an on-going, Michigan OSHA-approved safety-training program for employees to be used on the proposed job site.
2. Evidence of the bidder's worker's compensation Experience Modification Rating ("EMR"). Preference within this criterion will be given to an EMR of 1.0 or less based on a three-year average.
3. Evidence that all craft labor that will be employed by the bidder for the project has, or will have prior to project commencement, completed at least the OSHA 10-hour training course for safety established by the U.S. Department of Labor, Occupational Safety & Health Administration.
4. The safety record of bidder and major subcontractors, including OSHA, MIOSHA, or other safety violations.

**C. Workforce Development – 20 Points**

1. The ratio of masters or journeypersons to apprentices proposed to be used on the construction project job site, if apprentices are to be used on the project.
2. Documentation as to bidder's pay rates, health insurance, pension or other retirement benefits, paid leave, or other fringe benefits to its employees.
3. Documentation that the bidder participates in a Registered Apprenticeship Program that is registered with the United States Department of Labor Office of Apprenticeship or by a State Apprenticeship Agency recognized by the USDOL Office of Apprenticeship.

**D. Social Equity and Sustainability – 20 Points**

1. A statement from the bidder as to what percentage of its workforce resides in the City of Ann Arbor and in Washtenaw County, Michigan. The City will consider in evaluating which bids best serve its interests, the extent to which responsible and qualified bidders are able to achieve this goal.
2. Evidence of Equal Employment Opportunity Programs for minorities, women, veterans, returning citizens, and small businesses.

3. Evidence that the bidder is an equal opportunity employer and does not discriminate on the basis of race, sex, pregnancy, age, religion, national origin, marital status, sexual orientation, gender identity or expression, height, weight, or disability.
4. The bidder's proposed use of sustainable products, technologies, or practices for the project, which reduce the impact on human health and the environment, including raw materials acquisition, production, manufacturing, packaging, distribution, reuse, operation, maintenance, and waste management.
5. The bidder's environmental record, including findings of violations and penalties imposed by government agencies.

**E. Schedule of Pricing/Cost – 20 Points**

Company: \_\_\_\_\_

**Unit Price Bid –**

<b>Item Code</b>	<b>Item Description</b>	<b>Unit</b>	<b>Est Qty</b>	<b>Unit Price</b>	<b>Total Price</b>
101	Allowance for Incentives for Timely Completion of Work Phase 1	LSum	1		
102	Allowance for Incentives for Timely Completion of Work Phase 2	LSum	1		
103	Allowance for Incentives for Timely Completion of Work Phase 3	LSum	1		
201	General Conditions, Max \$400,000	LSum	1		
202	Certified Payroll Compliance and Reporting	LSum	1		
204	Minor Traffic Devices, Max \$160,000	LSum	1		
205	Audio-visual Recording	LSum	1		
206	Exploratory Excavation, (0-10 ft. deep) (Trench Det 1, Modified)	Ea	17		
207	Erosion Control, Inlet Filter	Ea	28		
208	Sewer, Any Size or Depth, Rem	Ft	208		
209	Dr Structure, Any Size or Depth, Rem	Ea	17		
210	Curb and Gutter, Any Type or Size, Rem	Ft	1308		
211	Sidewalk and Ramps, Rem	Sft	6833		
212	Pav't, Rem	Syd	4078		
213	Pav't, Rem, Special	Syd	2721		
214	Machine Grading, Modified, S Main	Sta	13.2		
215	Non-Hazardous Contam'd Mat'l Handling and Disposal (LM)	Cyd	200		
216	Subgrade Undercutting, Type II	Cyd	150		
217	Subgrade Undercutting, Type IV	Cyd	150		
218	Dr Structure Cover, Type Q, Special	Ea	35		
219	Dr Structure Cover, Type K, Special	Ea	16		

220	6 inch, Wrapped Underdrain	Ft	300		
221	Aggregate Base Course, 21AA, Modified	Ton	4500		
222	Subbase, CI II CIP	Cyd	1600		
223	Curb and Gutter, Conc, Match Existing, Special	Ft	1456		
224	Mountable Curb and Gutter	Ft	84		
225	Maintenance Gravel, 21AA, Modified	Ton	400		
226	Sidewalk, Concrete, 4 inch, Special	Sft	2627		
227	Sidewalk Ramp, Concrete, 6 inch, Special	Sft	1823		
228	Sidewalk, Concrete, 8 inch, Special	Sft	358		
229	Detectable Warning Surface, Modified	Ft	150		
230	Conc Base, 4 inch, Perforated	Sft	1857		
231	Brick Pavers, Rem, Sort and Salv	Sft	1956		
232	Brick Pavers, Install Salvaged	Sft	1857		
233	Trench Drain	LSum	1		
234	Hand Patching, Modified	Ton	100		
235	HMA, 3C (Base)	Ton	1231		
236	HMA, 4EML (Leveling)	Ton	828		
237	HMA, 5EML (Top)	Ton	828		
238	Band, Sign	Ea	32		
239	Fdn, Perforated Steel Square Tube Breakaway System, Rem	Ea	5		
240	Sign, Type III, Rem	Ea	36		
241	Sign, Type IIIA, Modified	Sft	28.5		
242	Sign, Type IIIB, Modified	Sft	69.5		
243	Reflective Panel for Permanent Sign Support, 3 foot, Modified	Ea	4		
244	Perforated Steel Square Tube Breakaway System, Modified	Ea	8		
247	Parking Meter, Rem	Ea	1		
248	Parking Meter, Install	Ea	1		
250	Rem Spec Mrkg	Sft	412		
251	Pavt Mrkg, Polyurea, 4 inch, White	Ft	358		

252	Pavt Mrkg, Polyurea, 4 inch, Yellow	Ft	3797		
253	Pavt Mrkg, Polyurea, 18 inch, White	Ft	78		
254	Pavt Mrkg, Polyurea, 12 inch, Crosswalk	Ft	1650		
255	Pavt Mrkg, Polyurea, 24 inch, Stop Bar	Ft	172		
256	Pavt Mrkg, Polyurea, Sharrow Sym	Ea	6		
257	Pavt Mrkg, Polyurea, Lt Turn Arrow Sym	Ea	5		
258	Recess Pavt Mrkg, Longit	Ft	6609		
258A	Recess Pavt Mrkg, Spec Mrkg	Sft	2350		
259	Scarification, for Polyurea Spec Mrkg	Sft	200		
260	Pavt Mrkg, Polyurea, 12 inch, Cross Hatching, Yellow	Ft	71		
261	Pavt Mrkg, Polyurea, Bike, Lt Turn Arrow Sym	Ea	2		
262	Pavt Mrkg, Polyurea, Bike, Rt Turn Arrow Sym	Ea	1		
263	Pavt Mrkg, Bike Lane, Green	Sft	572		
263A	Pavt Mrkg, Polyurea, Bike Sym	Ea	1		
263B	Pavt Mrkg, Polyurea, Bike, Stop Bar	Ft	18		
264	Pedestrian Path, Temp	Ft	500		
265	Pedestrian Ramp, Temp	Ea	15		
266	Pedestrian Type II Barricade, Temp	Ea	500		
267	Pedestrian Type II Channelizer, Temp	Ft	3600		
268	Barricade, Type III, High Intensity, Double Sided, Lighted, Furn	Ea	24		
269	Barricade, Type III, High Intensity, Double Sided, Lighted, Oper	Ea	24		
270	Plastic Drum, Fluorescent, Furn	Ea	30		
271	Plastic Drum, Fluorescent, Oper	Ea	30		
272	Sign, Type B, Temp, Prismatic, Furn	Sft	860		

273	Sign, Type B, Temp, Prismatic, Oper	Sft	860		
274	Sign, Type B, Temp, Prismatic, Spec, Furn	Sft	625		
275	Sign, Type B, Temp, Prismatic, Spec, Oper	Sft	625		
276	Sign, Portable, Changeable Message, NTCIP Compliant, Furn & Oper	Ea	2		
277	Lighted Arrow, Type C, Furn & Oper	Ea	4		
278	Sign Cover	Ea	20		
279	Traffic Regulator Control	LSum	1		
280	Project Supervision, Max \$100,000	LSum	1		
281	Pedestrian Barrier with Fence, Temp	Ft	200		
282	Flowable Fill (Backfill)	Cyd	10		
283	No Parking Sign	Ea	10		
284	Temporary Audible Message Device	Ea	36		
901	Line Stop, Ductile/Cast Iron Pipe, 8 inch	Ea	3		
902	Line Stop, Ductile/Cast Iron Pipe, 6 inch	Ea	6		
903	Line Stop, Ductile/Cast Iron Pipe, 10 inch	Ea	2		
904	Line Stop, Ductile/Cast Iron Pipe, 12 inch	Ea	2		
905	Line Stop, Additional Rental Day	Each	10		
906	CL 50, D.I. Water Main, w/Poly Wrap, 12 inch, Tr Det I, Mod	Ft	1464		
907	CL 50, D.I. Water Main, w/Poly Wrap, 8 inch, Tr Det I, Mod	Ft	101		
908	CL 50, D.I. Water Main, w/Poly Wrap, 6 inch, Tr Det I, Mod	Ft	264		
909	CL 50, D.I. Water Main, w/Poly Wrap, 4 inch, Tr Det I, Mod	Ft	342		
910	90 deg Bend, 12 inch	Ea	11		
911	90 deg Bend, 8 inch	Ea	3		
912	45 deg Bend, 12 inch	Ea	43		
913	45 deg Bend, 8 inch	Ea	4		

914	45 deg Bend, 6 inch	Ea	22		
915	45 deg Bend, 4 inch	Ea	30		
916	Reducer, 8 inch x 6 inch	Ea	7		
917	Reducer, 12 inch x 8 inch	Ea	1		
918	Cross, 12 inch x 12 inch	Ea	2		
919	Tee, 12 inch x 12 inch x 4 inch	Ea	13		
920	Tee, 12 inch x 12 inch x 6 inch	Ea	9		
921	Tee, 12 inch x 12 inch x 8 inch	Ea	9		
922	Tee, 12 inch x 12 inch x 12 inch	Ea	1		
923	Fire Hydrant Assembly, w/Extensions, Complete	Ea	8		
924	Gate Valve-in-Well, 12 inch	Ea	15		
925	Gate Valve-in-Box, 6 inch	Ea	16		
926	Gate Valve-in-Box, 4 inch	Ea	13		
927	Sacrificial Anode, 17 LB	Ea	1		
928	Sacrificial Anode, 32 LB	Ea	10		
929	Water Main, Abandon w/Flowable Fill	Ft	1542		
929A	Water Main Pipe Abandonment	Ft	300		
929B	Gate Valve-in-Well, Rem	Ea	5		
930	Gate Valve-in-Box, Abandon	Ea	10		
931	Gate Valve-in-Well, Abandon	Ea	5		
932	Fire Hydrant, Remove	Ea	6		
933	Meter Pit, Complete	Ea	14		
934	Water Fountain, Salv, Rem	Ea	6		
935	Water Fountain, Salv, Install	Ea	6		
936	Water Fountain, Winterization Box, Complete	Ea	6		
937	RCP, Sewer, C76, CL-IV, 12 inch, Tr Det I	Ft	213		
938	RCP, Sewer, C76, CL-IV, 18 inch, Tr Det I	Ft	55		
939	Sewer, SDR 35 PVC Pipe, 6 inch, Tr Det I	Ft	46		
940	Sewer, SDR 35 PVC Pipe, 10 inch, Tr Det I	Ft	38		
941	SDR 35, PVC Service Lead	Ft	50		
942	SDR 35, PVC Tee	Ea	5		
943	SDR 35, PVC Riser	VFt	10		

944	Type I Manhole (4 ft dia) (0-10 ft. Deep)	Ft	4		
945	Single Inlet with 2 Foot Sump	Ea	15		
946	Excavate & Backfill for Water Service Tap and Lead	Ft	493		
947	Adjust Structure Cover	Ea	21		
948	Adjust Monument Box or Gate Valve Box	Ea	4		
949	Hh, Adj	Ea	12		
950	TS Face, Bag	Ea	4		
951	TS Face Bag, Rem	Ea	4		
954	TS, Pedestrian, Bracket Arm Mtd, Rem	Ea	4		
955	TS, Pedestrian, Pedestal Mtd, Rem	Ea	1		
956	Pedestal, Rem	Ea	1		
957	Pedestal Fdn, Rem	Ea	1		
958	Sign, Type III, Rem	Ea	1		
959	Conduit, Rem	Ft	8		
960	TS, Pedestrian, One Way Bracket Arm Mtd (LED) Countdown	Ea	1		
961	TS, Pedestrian, One Way Pedestal Mtd (LED) Countdown	Ea	9		
962	Pedestal, Alum	Ea	9		
963	Pedestal, Fdn	Ea	9		
964	Sign, Type III, Erect, Salv	Ea	1		
966	Wireless Vehicle Sensor Node, Rem	Ea	4		
967	Wireless Vehicle Sensor Node, Salv	Ea	4		
968	Hand Hole Assembly, Remove and Replace, All Sizes	Ea	10		
969	Hand Hole Assembly, 12 inch x 18 inch	Ea	4		
969A	Hand Hole Assembly, 17 inch x 30 inch	Ea	4		
969B	Hand Hole Assembly, 24 inch x 36 inch	Ea	10		
970	Light Fdn, Post, Electrical, Rem, Salv, Reinstall	LSum	1		



971	2 inch Schedule 80 PVC Electrical Conduit	Ft	95		
972	3 inch Schedule 80 PVC Electrical Conduit	Ft	60		
973	Recable, TS	Ft	200		
974	Reconstruct Structure	Ea	6		
975	Additional Depth Structure Adjust/Repair	Ft	10		
976	Protective Fence, Orange, Plastic, 4 foot Ht	Lft	1200		

**TOTAL CONTRACT PRICE**

**\$ \_\_\_\_\_**

## **F. AUTHORIZED NEGOTIATOR / NEGOTIATIBLE ELEMENTS (ALTERNATES)**

Include the name, phone number, and e-mail address of persons(s) in your organization authorized to negotiate the agreement with the City.

The proposal price shall include materials and equipment selected from the designated items and manufacturers listed in the bidding documents. This is done to establish uniformity in bidding and to establish standards of quality for the items named.

If the bidder wishes to quote alternate items for consideration by the City, it may do so under this Section. A complete description of the item and the proposed price differential must be provided. Unless approved at the time of award, substitutions where items are specifically named will be considered only as a negotiated change in Contract Sum.

If the Bidder takes exception to the time stipulated in Article III of the Contract, Time of Completion, page C-2, it is requested to stipulate its proposed time for performance of the work.

Consideration for any proposed alternative items or time may be negotiated at the discretion of the City.

## **G. ATTACHMENTS**

General Declaration, Legal Status of Bidder, Conflict of Interest Form, Living Wage Compliance Form, Prevailing Wage Compliance Form and the Non-Discrimination Form should be completed and returned with the proposal. These elements should be included as attachments to the proposal submission.

## **PROPOSAL EVALUATION**

1. The selection committee will evaluate each proposal by the above-described criteria and point system. The City reserves the right to reject any proposal that it determines to be unresponsive and deficient in any of the information requested for evaluation. A proposal with all the requested information does not guarantee the proposing firm to be a candidate for an interview if interviews are selected to be held by the City. The committee may contact references to verify material submitted by the bidder.
2. The committee then will schedule interviews with the selected firms if necessary. The selected firms will be given the opportunity to discuss in more detail their qualifications, past experience, proposed work plan (if applicable) and pricing.
3. The interview should include the project team members expected to work on the project, but no more than six members total. The interview shall consist of a

presentation of up to thirty minutes (or the length provided by the committee) by the bidder, including the person who will be the project manager on this contract, followed by approximately thirty minutes of questions and answers. Audiovisual aids may be used during the oral interviews. The committee may record the oral interviews.

4. The firms interviewed will then be re-evaluated by the above criteria and adjustments to scoring will be made as appropriate. After evaluation of the proposals, further negotiation with the selected firm may be pursued leading to the award of a contract by City Council, if suitable proposals are received.

The City reserves the right to waive the interview process and evaluate the bidder based on their proposal and pricing schedules alone.

The City will determine whether the final scope of the project to be negotiated will be entirely as described in this RFP, a portion of the scope, or a revised scope.

Work to be done under this contract is generally described through the detailed specifications and must be completed fully in accordance with the contract documents.

Any proposal that does not conform fully to these instructions may be rejected.

## **PREPARATION OF PROPOSALS**

Proposals should have no plastic bindings but will not be rejected as non-responsive for being bound. Staples or binder clips are acceptable. Proposals should be printed double sided on recycled paper.

Each person signing the proposal certifies that they are a person in the bidder's firm/organization responsible for the decisions regarding the fees being offered in the Proposal and has not and will not participate in any action contrary to the terms of this provision.

## **ADDENDA**

If it becomes necessary to revise any part of the RFP, notice of the addendum will be posted to Michigan Inter-governmental Trade Network (MITN) [www.mitn.info](http://www.mitn.info) and/or the City of Ann Arbor web site [www.A2gov.org](http://www.A2gov.org) for all parties to download.

Each bidder should acknowledge in its proposal all addenda it has received on the General Declarations form provided in the Attachments section herein. The failure of a bidder to receive or acknowledge receipt of any addenda shall not relieve the bidder of the responsibility for complying with the terms thereof. The City will not be bound by oral responses to inquiries or written responses other than official written addenda.

## **SECTION IV - ATTACHMENTS**

Attachment A – Sample Standard Contract

Attachment B – General Declarations

Attachment C - Legal Status of Bidder

Attachment D – Prevailing Wage Declaration of Compliance Form

Attachment E – Living Wage Declaration of Compliance Form

Attachment F – Living Wage Ordinance Poster

Attachment G – Vendor Conflict of Interest Disclosure Form

Attachment H – Non-Discrimination Ordinance Declaration of Compliance Form

Attachment I – Non-Discrimination Ordinance Poster

Sample Certified Payroll Report Template

# ATTACHMENT A SAMPLE STANDARD CONTRACT

*If a contract is awarded, the selected contractor will be required to adhere to a set of general contract provisions which will become a part of any formal agreement. These provisions are general principles which apply to all contractors of service to the City of Ann Arbor such as the following:*

**Administrative Use Only**  
Contract Date: \_\_\_\_\_

## CONTRACT

THIS CONTRACT is between the CITY OF ANN ARBOR, a Michigan Municipal Corporation, 301 East Huron Street, Ann Arbor, Michigan 48104 ("City") and \_\_\_\_\_ ("Contractor")

\_\_\_\_\_  
(An individual/partnership/corporation, include state of incorporation) (Address)

Based upon the mutual promises below, the Contractor and the City agree as follows:

### ARTICLE I - Scope of Work

The Contractor agrees to furnish all of the materials, equipment and labor necessary; and to abide by all the duties and responsibilities applicable to it for the project titled **[Insert Title of Bid and Bid Number]** in accordance with the requirements and provisions of the following documents, including all written modifications incorporated into any of the documents, all of which are incorporated as part of this Contract:

- |  |                         |
|--|-------------------------|
| Non-discrimination and Living Wage Declaration of Compliance Forms (if applicable) | General Conditions      |
| Vendor Conflict of Interest Form   | Standard Specifications |
| Prevailing Wage Declaration of Compliance Form (if applicable)                     | Detailed Specifications |
| Bid Forms  | Plans                   |
| Contract and Exhibits  | Addenda                 |
| Bonds  |                         |

### ARTICLE II - Definitions

**Administering Service Area/Unit** means **[Insert Name of Administering Service Unit]**

**Project** means **[Insert Title of Bid and Bid Number]**

**Supervising Professional** means the person acting under the authorization of the manager of the Administering Service Area/Unit. At the time this Contract is executed,

the Supervising Professional is: **[Insert the person's name]** whose job title is **[Insert job title]**. If there is any question concerning who the Supervising Professional is, Contractor shall confirm with the manager of the Administering Service Area/Unit.

**Contractor's Representative** means \_\_\_\_\_ **[Insert name]** whose job title is **[Insert job title]**.

**ARTICLE III - Time of Completion**

- (A) The work to be completed under this Contract shall begin immediately on the date specified in the Notice to Proceed issued by the City.
- (B) The entire work for this Contract shall be completed within \_\_\_\_\_ ( ) consecutive calendar days.
- (C) Failure to complete all the work within the time specified above, including any extension granted in writing by the Supervising Professional, shall obligate the Contractor to pay the City, as liquidated damages and not as a penalty, an amount equal to \$\_\_\_\_\_ for each calendar day of delay in the completion of all the work. If any liquidated damages are unpaid by the Contractor, the City shall be entitled to deduct these unpaid liquidated damages from the monies due the Contractor.

The liquidated damages are for the non-quantifiable aspects of any of the previously identified events and do not cover actual damages that can be shown or quantified nor are they intended to preclude recovery of actual damages in addition to the recovery of liquidated damages.

**ARTICLE IV - The Contract Sum**

**Choose one only.**

- (A) The City shall pay to the Contractor for the performance of the Contract, the lump sum price as given in the Bid Form in the amount of:

\_\_\_\_\_ Dollars (\$\_\_\_\_\_)

**Or**

- (A) The City shall pay to the Contractor for the performance of the Contract, the unit prices as given in the Bid Form for the estimated bid total of:

\_\_\_\_\_ Dollars (\$\_\_\_\_\_)

- (B) The amount paid shall be equitably adjusted to cover changes in the work ordered by the Supervising Professional but not required by the Contract Documents.

Increases or decreases shall be determined only by written agreement between the City and Contractor.

#### **ARTICLE V - Assignment**

This Contract may not be assigned or subcontracted any portion of any right or obligation under this contract without the written consent of the City. Notwithstanding any consent by the City to any assignment, Contractor shall at all times remain bound to all warranties, certifications, indemnifications, promises and performances, however described, as are required of it under this contract unless specifically released from the requirement, in writing, by the City.

#### **ARTICLE VI - Choice of Law**

This Contract shall be construed, governed, and enforced in accordance with the laws of the State of Michigan. By executing this Contract, the Contractor and the City agree to venue in a court of appropriate jurisdiction sitting within Washtenaw County for purposes of any action arising under this Contract. The parties stipulate that the venue referenced in this Contract is for convenience and waive any claim of non-convenience.

Whenever possible, each provision of the Contract will be interpreted in a manner as to be effective and valid under applicable law. The prohibition or invalidity, under applicable law, of any provision will not invalidate the remainder of the Contract.

#### **ARTICLE VII - Relationship of the Parties**

The parties of the Contract agree that it is not a Contract of employment but is a Contract to accomplish a specific result. Contractor is an independent Contractor performing services for the City. Nothing contained in this Contract shall be deemed to constitute any other relationship between the City and the Contractor.

Contractor certifies that it has no personal or financial interest in the project other than the compensation it is to receive under the Contract. Contractor certifies that it is not, and shall not become, overdue or in default to the City for any Contract, debt, or any other obligation to the City including real or personal property taxes. City shall have the right to set off any such debt against compensation awarded for services under this Contract.

#### **ARTICLE VIII - Notice**

All notices given under this Contract shall be in writing, and shall be by personal delivery or by certified mail with return receipt requested to the parties at their respective addresses as specified in the Contract Documents or other address the Contractor may specify in writing. Notice will be deemed given on the date when one of the following first occur: (1) the date of actual receipt; or (2) three days after mailing certified U.S. mail.

**ARTICLE IX - Indemnification**

To the fullest extent permitted by law, Contractor shall indemnify, defend and hold the City, its officers, employees and agents harmless from all suits, claims, judgments and expenses including attorney’s fees resulting or alleged to result, in whole or in part, from any act or omission, which is in any way connected or associated with this Contract, by the Contractor or anyone acting on the Contractor’s behalf under this Contract. Contractor shall not be responsible to indemnify the City for losses or damages caused by or resulting from the City’s sole negligence. The provisions of this Article shall survive the expiration or earlier termination of this contract for any reason.

**ARTICLE X - Entire Agreement**

This Contract represents the entire understanding between the City and the Contractor and it supersedes all prior representations, negotiations, agreements, or understandings whether written or oral. Neither party has relied on any prior representations in entering into this Contract. No terms or conditions of either party’s invoice, purchase order or other administrative document shall modify the terms and conditions of this Contract, regardless of the other party’s failure to object to such form. This Contract shall be binding on and shall inure to the benefit of the parties to this Contract and their permitted successors and permitted assigns and nothing in this Contract, express or implied, is intended to or shall confer on any other person or entity any legal or equitable right, benefit, or remedy of any nature whatsoever under or by reason of this Contract. This Contract may be altered, amended or modified only by written amendment signed by the City and the Contractor.

**ARTICLE XI – Electronic Transactions**

The City and Contractor agree that signatures on this Contract may be delivered electronically in lieu of an original signature and agree to treat electronic signatures as original signatures that bind them to this Contract. This Contract may be executed and delivered by facsimile and upon such delivery, the facsimile signature will be deemed to have the same effect as if the original signature had been delivered to the other party.

**FOR CONTRACTOR**

By \_\_\_\_\_

Its: \_\_\_\_\_

**FOR THE CITY OF ANN ARBOR**

By \_\_\_\_\_  
Christopher Taylor, Mayor

By \_\_\_\_\_  
Jacqueline Beaudry, City Clerk

**Approved as to substance**

By \_\_\_\_\_  
City Administrator



By \_\_\_\_\_

Services Area Administrator

**Approved as to form and content**

\_\_\_\_\_  
Atleen Kaur, City Attorney

**PERFORMANCE BOND**

- (1) \_\_\_\_\_ of \_\_\_\_\_ (referred to as "Principal"), and \_\_\_\_\_, a corporation duly authorized to do business in the State of Michigan (referred to as "Surety"), are bound to the City of Ann Arbor, Michigan (referred to as "City"), for \$ \_\_\_\_\_, the payment of which Principal and Surety bind themselves, their heirs, executors, administrators, successors and assigns, jointly and severally, by this bond.
- (2) The Principal has entered a written Contract with the City entitled \_\_\_\_\_, for RFP No. \_\_\_\_\_ and this bond is given for that Contract in compliance with Act No. 213 of the Michigan Public Acts of 1963, as amended, being MCL 129.201 et seq.
- (3) Whenever the Principal is declared by the City to be in default under the Contract, the Surety may promptly remedy the default or shall promptly:
- (a) complete the Contract in accordance with its terms and conditions; or
  - (b) obtain a bid or bids for submission to the City for completing the Contract in accordance with its terms and conditions, and upon determination by Surety of the lowest responsible bidder, arrange for a Contract between such bidder and the City, and make available, as work progresses, sufficient funds to pay the cost of completion less the balance of the Contract price; but not exceeding, including other costs and damages for which Surety may be liable hereunder, the amount set forth in paragraph 1.
- (4) Surety shall have no obligation to the City if the Principal fully and promptly performs under the Contract.
- (5) Surety agrees that no change, extension of time, alteration or addition to the terms of the Contract or to the work to be performed thereunder, or the specifications accompanying it shall in any way affect its obligations on this bond, and waives notice of any such change, extension of time, alteration or addition to the terms of the Contract or to the work, or to the specifications.
- (6) Principal, Surety, and the City agree that signatures on this bond may be delivered electronically in lieu of an original signature and agree to treat electronic signatures as original signatures that bind them to this bond. This bond may be executed and delivered by facsimile and upon such delivery, the facsimile signature will be deemed to have the same effect as if the original signature had been delivered to the other party.

**SIGNED AND SEALED** this \_\_\_\_\_ day of \_\_\_\_\_, 202\_.

\_\_\_\_\_  
(Name of Surety Company)

By \_\_\_\_\_  
(Signature)

Its \_\_\_\_\_  
(Title of Office)

Approved as to form:

\_\_\_\_\_  
Atleen Kaur, City Attorney

\_\_\_\_\_  
(Name of Principal)

By \_\_\_\_\_  
(Signature)

Its \_\_\_\_\_  
(Title of Office)

Name and address of agent:

\_\_\_\_\_

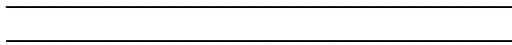

2

## LABOR AND MATERIAL BOND

- (1) \_\_\_\_\_  
of \_\_\_\_\_ (referred to as "Principal"), and \_\_\_\_\_, a corporation duly authorized to do business in the State of Michigan, (referred to as "Surety"), are bound to the City of Ann Arbor, Michigan (referred to as "City"), for the use and benefit of claimants as defined in Act 213 of Michigan Public Acts of 1963, as amended, being MCL 129.201 et seq., in the amount of \$ \_\_\_\_\_, for the payment of which Principal and Surety bind themselves, their heirs, executors, administrators, successors and assigns, jointly and severally, by this bond.
- (2) The Principal has entered a written Contract with the City entitled \_\_\_\_\_  
\_\_\_\_\_  
\_\_\_\_\_, for RFP No. \_\_\_\_\_; and this bond is given for that Contract in compliance with Act No. 213 of the Michigan Public Acts of 1963 as amended;
- (3) If the Principal fails to promptly and fully repay claimants for labor and material reasonably required under the Contract, the Surety shall pay those claimants.
- (4) Surety's obligations shall not exceed the amount stated in paragraph 1, and Surety shall have no obligation if the Principal promptly and fully pays the claimants.
- (5) Principal, Surety, and the City agree that signatures on this bond may be delivered electronically in lieu of an original signature and agree to treat electronic signatures as original signatures that bind them to this bond. This bond may be executed and delivered by facsimile and upon such delivery, the facsimile signature will be deemed to have the same effect as if the original signature had been delivered to the other party.

**SIGNED AND SEALED** this \_\_\_\_\_ day of \_\_\_\_\_, 202\_\_

\_\_\_\_\_  
(Name of Surety Company)  
By \_\_\_\_\_  
(Signature)  
Its \_\_\_\_\_  
(Title of Office)

\_\_\_\_\_  
(Name of Principal)  
By \_\_\_\_\_  
(Signature)  
Its \_\_\_\_\_  
(Title of Office)

Approved as to form:

\_\_\_\_\_

Atleen Kaur, City Attorney

Name and address of agent:

\_\_\_\_\_  
\_\_\_\_\_  
\_\_\_\_\_

## **GENERAL CONDITIONS**

### **Section 1 - Execution, Correlation and Intent of Documents**

The contract documents shall be signed in 2 copies by the City and the Contractor.

The contract documents are complementary and what is called for by any one shall be binding. The intention of the documents is to include all labor and materials, equipment and transportation necessary for the proper execution of the work. Materials or work described in words which so applied have a well-known technical or trade meaning have the meaning of those recognized standards.

In case of a conflict among the contract documents listed below in any requirement(s), the requirement(s) of the document listed first shall prevail over any conflicting requirement(s) of a document listed later.

(1) Addenda in reverse chronological order; (2) Detailed Specifications; (3) Standard Specifications; (4) Plans; (5) General Conditions; (6) Contract; (7) Bid Forms; (8) Bond Forms; (9) Bid.

### **Section 2 - Order of Completion**

The Contractor shall submit with each invoice, and at other times reasonably requested by the Supervising Professional, schedules showing the order in which the Contractor proposes to carry on the work. They shall include the dates at which the Contractor will start the several parts of the work, the estimated dates of completion of the several parts, and important milestones within the several parts.

### **Section 3 - Familiarity with Work**

The Bidder or its representative shall make personal investigations of the site of the work and of existing structures and shall determine to its own satisfaction the conditions to be encountered, the nature of the ground, the difficulties involved, and all other factors affecting the work proposed under this Contract. The Bidder to whom this Contract is awarded will not be entitled to any additional compensation unless conditions are clearly different from those which could reasonably have been anticipated by a person making diligent and thorough investigation of the site.

The Bidder shall immediately notify the City upon discovery, and in every case prior to submitting its Bid, of every error or omission in the bidding documents that would be identified by a reasonably competent, diligent Bidder. In no case will a Bidder be allowed the benefit of extra compensation or time to complete the work under this Contract for extra expenses or time spent as a result of the error or omission.

### **Section 4 - Wage Requirements**

Under this Contract, the Contractor shall conform to Chapter 14 of Title I of the Code of the City of Ann Arbor as amended; which in part states "...that all craftsmen, mechanics and laborers employed directly on the site in connection with said improvements, including said employees of

subcontractors, shall receive the prevailing wage for the corresponding classes of craftsmen, mechanics and laborers, as determined by statistics for the Ann Arbor area compiled by the United States Department of Labor. At the request of the City, any contractor or subcontractor shall provide satisfactory proof of compliance with the contract provisions required by the Section.

Pursuant to Resolution R-16-469 all public improvement contractors are subject to prevailing wage and will be required to provide to the City payroll records sufficient to demonstrate compliance with the prevailing wage requirements. A sample Prevailing Wage Form is provided in the Appendix herein for reference as to what will be expected from contractors. Use of the Prevailing Wage Form provided in the Appendix section or a City-approved equivalent will be required along with wage rate interviews.

Where the Contract and the Ann Arbor City Ordinance are silent as to definitions of terms required in determining contract compliance with regard to prevailing wages, the definitions provided in the Davis-Bacon Act as amended (40 U.S.C. 278-a to 276-a-7) for the terms shall be used.

If the Contractor is a "covered employer" as defined in Chapter 23 of the Ann Arbor City Code, the Contractor agrees to comply with the living wage provisions of Chapter 23 of the Ann Arbor City Code. The Contractor agrees to pay those employees providing Services to the City under this Contract a "living wage," as defined in Section 1:815 of the Ann Arbor City Code, as adjusted in accordance with Section 1:815(3); to post a notice approved by the City of the applicability of Chapter 23 in every location in which regular or contract employees providing services under this Contract are working; to maintain records of compliance; if requested by the City, to provide documentation to verify compliance; to take no action that would reduce the compensation, wages, fringe benefits, or leave available to any employee or person contracted for employment in order to pay the living wage required by Section 1:815; and otherwise to comply with the requirements of Chapter 23.

Contractor agrees that all subcontracts entered into by the Contractor shall contain similar wage provision covering subcontractor's employees who perform work on this contract.

## **Section 5 - Non-Discrimination**

The Contractor agrees to comply, and to require its subcontractor(s) to comply, with the nondiscrimination provisions of MCL 37.2209. The Contractor further agrees to comply with the provisions of Section 9:158 of Chapter 112 of Title IX of the Ann Arbor City Code, and to assure that applicants are employed and that employees are treated during employment in a manner which provides equal employment opportunity.

## **Section 6 - Materials, Appliances, Employees**

Unless otherwise stipulated, the Contractor shall provide and pay for all materials, labor, water, tools, equipment, light, power, transportation, and other facilities necessary or used for the execution and completion of the work. Unless otherwise specified, all materials incorporated in the permanent work shall be new, and both workmanship and materials shall be of the highest quality. The Contractor shall, if required, furnish satisfactory evidence as to the kind and quality of materials.

The Contractor shall at all times enforce strict discipline and good order among its employees, and shall seek to avoid employing on the work any unfit person or anyone not skilled in the work assigned.

Adequate sanitary facilities shall be provided by the Contractor.

## **Section 7 - Qualifications for Employment**

The Contractor shall employ competent laborers and mechanics for the work under this Contract. For work performed under this Contract, employment preference shall be given to qualified local residents.

## **Section 8 - Royalties and Patents**

The Contractor shall pay all royalties and license fees. It shall defend all suits or claims for infringements of any patent rights and shall hold the City harmless from loss on account of infringement except that the City shall be responsible for all infringement loss when a particular process or the product of a particular manufacturer or manufacturers is specified, unless the City has notified the Contractor prior to the signing of the Contract that the particular process or product is patented or is believed to be patented.

## **Section 9 - Permits and Regulations**

The Contractor must secure and pay for all permits, permit or plan review fees and licenses necessary for the prosecution of the work. These include but are not limited to City building permits, right-of-way permits, lane closure permits, right-of-way occupancy permits, and the like. The City shall secure and pay for easements shown on the plans unless otherwise specified.

The Contractor shall give all notices and comply with all laws, ordinances, rules and regulations bearing on the conduct of the work as drawn and specified. If the Contractor observes that the contract documents are at variance with those requirements, it shall promptly notify the Supervising Professional in writing, and any necessary changes shall be adjusted as provided in the Contract for changes in the work.

## **Section 10 - Protection of the Public and of Work and Property**

The Contractor is responsible for the means, methods, sequences, techniques and procedures of construction and safety programs associated with the work contemplated by this contract. The Contractor, its agents or sub-contractors, shall comply with the "General Rules and Regulations for the Construction Industry" as published by the Construction Safety Commission of the State of Michigan and to all other local, State and National laws, ordinances, rules and regulations pertaining to safety of persons and property.

The Contractor shall take all necessary and reasonable precautions to protect the safety of the public. It shall continuously maintain adequate protection of all work from damage, and shall take all necessary and reasonable precautions to adequately protect all public and private property from injury or loss arising in connection with this Contract. It shall make good any damage, injury or loss to its work and to public and private property resulting from lack of reasonable protective precautions, except as may be due to errors in the contract documents, or caused by agents or



employees of the City. The Contractor shall obtain and maintain sufficient insurance to cover damage to any City property at the site by any cause.

In an emergency affecting the safety of life, or the work, or of adjoining property, the Contractor is, without special instructions or authorization from the Supervising Professional, permitted to act at its discretion to prevent the threatened loss or injury. It shall also so act, without appeal, if authorized or instructed by the Supervising Professional.

Any compensation claimed by the Contractor for emergency work shall be determined by agreement or in accordance with the terms of Claims for Extra Cost - Section 15.

## **Section 11 - Inspection of Work**

The City shall provide sufficient competent personnel for the inspection of the work.

The Supervising Professional shall at all times have access to the work whenever it is in preparation or progress, and the Contractor shall provide proper facilities for access and for inspection.

If the specifications, the Supervising Professional's instructions, laws, ordinances, or any public authority require any work to be specially tested or approved, the Contractor shall give the Supervising Professional timely notice of its readiness for inspection, and if the inspection is by an authority other than the Supervising Professional, of the date fixed for the inspection. Inspections by the Supervising Professional shall be made promptly, and where practicable at the source of supply. If any work should be covered up without approval or consent of the Supervising Professional, it must, if required by the Supervising Professional, be uncovered for examination and properly restored at the Contractor's expense.

Re-examination of any work may be ordered by the Supervising Professional, and, if so ordered, the work must be uncovered by the Contractor. If the work is found to be in accordance with the contract documents, the City shall pay the cost of re-examination and replacement. If the work is not in accordance with the contract documents, the Contractor shall pay the cost.

## **Section 12 - Superintendence**

The Contractor shall keep on the work site, during its progress, a competent superintendent and any necessary assistants, all satisfactory to the Supervising Professional. The superintendent will be responsible to perform all on-site project management for the Contractor. The superintendent shall be experienced in the work required for this Contract. The superintendent shall represent the Contractor and all direction given to the superintendent shall be binding as if given to the Contractor. Important directions shall immediately be confirmed in writing to the Contractor. Other directions will be confirmed on written request. The Contractor shall give efficient superintendence to the work, using its best skill and attention.

## **Section 13 - Changes in the Work**

The City may make changes to the quantities of work within the general scope of the Contract at any time by a written order and without notice to the sureties. If the changes add to or deduct from the extent of the work, the Contract Sum shall be adjusted accordingly. All the changes shall be

executed under the conditions of the original Contract except that any claim for extension of time caused by the change shall be adjusted at the time of ordering the change.

In giving instructions, the Supervising Professional shall have authority to make minor changes in the work not involving extra cost and not inconsistent with the purposes of the work, but otherwise, except in an emergency endangering life or property, no extra work or change shall be made unless in pursuance of a written order by the Supervising Professional, and no claim for an addition to the Contract Sum shall be valid unless the additional work was ordered in writing.

The Contractor shall proceed with the work as changed and the value of the work shall be determined as provided in Claims for Extra Cost - Section 15.

## **Section 14 - Extension of Time**

Extension of time stipulated in the Contract for completion of the work will be made if and as the Supervising Professional may deem proper under any of the following circumstances:

- (1) When work under an extra work order is added to the work under this Contract;
- (2) When the work is suspended as provided in Section 20;
- (3) When the work of the Contractor is delayed on account of conditions which could not have been foreseen, or which were beyond the control of the Contractor, and which were not the result of its fault or negligence;
- (4) Delays in the progress of the work caused by any act or neglect of the City or of its employees or by other Contractors employed by the City;
- (5) Delay due to an act of Government;
- (6) Delay by the Supervising Professional in the furnishing of plans and necessary information;
- (7) Other cause which in the opinion of the Supervising Professional entitles the Contractor to an extension of time.

The Contractor shall notify the Supervising Professional within 7 days of an occurrence or conditions which, in the Contractor's opinion, entitle it to an extension of time. The notice shall be in writing and submitted in ample time to permit full investigation and evaluation of the Contractor's claim. The Supervising Professional shall acknowledge receipt of the Contractor's notice within 7 days of its receipt. Failure to timely provide the written notice shall constitute a waiver by the Contractor of any claim.

In situations where an extension of time in contract completion is appropriate under this or any other section of the contract, the Contractor understands and agrees that the only available adjustment for events that cause any delays in contract completion shall be extension of the required time for contract completion and that there shall be no adjustments in the money due the Contractor on account of the delay.

## Section 15 - Claims for Extra Cost

If the Contractor claims that any instructions by drawings or other media issued after the date of the Contract involved extra cost under this Contract, it shall give the Supervising Professional written notice within 7 days after the receipt of the instructions, and in any event before proceeding to execute the work, except in emergency endangering life or property. The procedure shall then be as provided for Changes in the Work-Section I3. No claim shall be valid unless so made.

If the Supervising Professional orders, in writing, the performance of any work not covered by the contract documents, and for which no item of work is provided in the Contract, and for which no unit price or lump sum basis can be agreed upon, then the extra work shall be done on a Cost-Plus-Percentage basis of payment as follows:

- (1) The Contractor shall be reimbursed for all reasonable costs incurred in doing the work, and shall receive an additional payment of 15% of all the reasonable costs to cover both its indirect overhead costs and profit;
- (2) The term "Cost" shall cover all payroll charges for employees and supervision required under the specific order, together with all worker's compensation, Social Security, pension and retirement allowances and social insurance, or other regular payroll charges on same; the cost of all material and supplies required of either temporary or permanent character; rental of all power-driven equipment at agreed upon rates, together with cost of fuel and supply charges for the equipment; and any costs incurred by the Contractor as a direct result of executing the order, if approved by the Supervising Professional;
- (3) If the extra is performed under subcontract, the subcontractor shall be allowed to compute its charges as described above. The Contractor shall be permitted to add an additional charge of 5% percent to that of the subcontractor for the Contractor's supervision and contractual responsibility;
- (4) The quantities and items of work done each day shall be submitted to the Supervising Professional in a satisfactory form on the succeeding day, and shall be approved by the Supervising Professional and the Contractor or adjusted at once;
- (5) Payments of all charges for work under this Section in any one month shall be made along with normal progress payments. Retainage shall be in accordance with Progress Payments-Section 16.

No additional compensation will be provided for additional equipment, materials, personnel, overtime or special charges required to perform the work within the time requirements of the Contract.

When extra work is required and no suitable price for machinery and equipment can be determined in accordance with this Section, the hourly rate paid shall be 1/40 of the basic weekly rate listed in the Rental Rate Blue Book published by Dataquest Incorporated and applicable to the time period the equipment was first used for the extra work. The hourly rate will be deemed to include all costs of operation such as bucket or blade, fuel, maintenance, "regional factors", insurance, taxes, and the like, but not the costs of the operator.

## **Section 16 - Progress Payments**

The Contractor shall submit each month, or at longer intervals, if it so desires, an invoice covering work performed for which it believes payment, under the Contract terms, is due. The submission shall be to the City's Finance Department - Accounting Division. The Supervising Professional will, within 10 days following submission of the invoice, prepare a certificate for payment for the work in an amount to be determined by the Supervising Professional as fairly representing the acceptable work performed during the period covered by the Contractor's invoice. To insure the proper performance of this Contract, the City will retain a percentage of the estimate in accordance with Act 524, Public Acts of 1980. The City will then, following the receipt of the Supervising Professional's Certificate, make payment to the Contractor as soon as feasible, which is anticipated will be within 15 days.

An allowance may be made in progress payments if substantial quantities of permanent material have been delivered to the site but not incorporated in the completed work if the Contractor, in the opinion of the Supervising Professional, is diligently pursuing the work under this Contract. Such materials shall be properly stored and adequately protected. Allowance in the estimate shall be at the invoice price value of the items. Notwithstanding any payment of any allowance, all risk of loss due to vandalism or any damages to the stored materials remains with the Contractor.

In the case of Contracts which include only the Furnishing and Delivering of Equipment, the payments shall be; 60% of the Contract Sum upon the delivery of all equipment to be furnished, or in the case of delivery of a usable portion of the equipment in advance of the total equipment delivery, 60% of the estimated value of the portion of the equipment may be paid upon its delivery in advance of the time of the remainder of the equipment to be furnished; 30% of the Contract Sum upon completion of erection of all equipment furnished, but not later than 60 days after the date of delivery of all of the equipment to be furnished; and payment of the final 10% on final completion of erection, testing and acceptance of all the equipment to be furnished; but not later than 180 days after the date of delivery of all of the equipment to be furnished, unless testing has been completed and shows the equipment to be unacceptable.

With each invoice for periodic payment, the Contractor shall enclose a Contractor's Declaration - Section 43, and an updated project schedule per Order of Completion - Section 2.

## **Section 17 - Deductions for Uncorrected Work**

If the Supervising Professional decides it is inexpedient to correct work that has been damaged or that was not done in accordance with the Contract, an equitable deduction from the Contract price shall be made.

## **Section 18 - Correction of Work Before Final Payment**

The Contractor shall promptly remove from the premises all materials condemned by the Supervising Professional as failing to meet Contract requirements, whether incorporated in the work or not, and the Contractor shall promptly replace and re-execute the work in accordance with the Contract and without expense to the City and shall bear the expense of making good all work of other contractors destroyed or damaged by the removal or replacement.

If the Contractor does not remove the condemned work and materials within 10 days after written notice, the City may remove them and, if the removed material has value, may store the material

at the expense of the Contractor. If the Contractor does not pay the expense of the removal within 10 days thereafter, the City may, upon 10 days written notice, sell the removed materials at auction or private sale and shall pay to the Contractor the net proceeds, after deducting all costs and expenses that should have been borne by the Contractor. If the removed material has no value, the Contractor must pay the City the expenses for disposal within 10 days of invoice for the disposal costs.

The inspection or lack of inspection of any material or work pertaining to this Contract shall not relieve the Contractor of its obligation to fulfill this Contract and defective work shall be made good. Unsuitable materials may be rejected by the Supervising Professional notwithstanding that the work and materials have been previously overlooked by the Supervising Professional and accepted or estimated for payment or paid for. If the work or any part shall be found defective at any time before the final acceptance of the whole work, the Contractor shall forthwith make good the defect in a manner satisfactory to the Supervising Professional. The judgment and the decision of the Supervising Professional as to whether the materials supplied and the work done under this Contract comply with the requirements of the Contract shall be conclusive and final.

## **Section 19 - Acceptance and Final Payment**

Upon receipt of written notice that the work is ready for final inspection and acceptance, the Supervising Professional will promptly make the inspection. When the Supervising Professional finds the work acceptable under the Contract and the Contract fully performed, the Supervising Professional will promptly sign and issue a final certificate stating that the work required by this Contract has been completed and is accepted by the City under the terms and conditions of the Contract. The entire balance found to be due the Contractor, including the retained percentage, shall be paid to the Contractor by the City within 30 days after the date of the final certificate.

Before issuance of final certificates, the Contractor shall file with the City:

- (1) The consent of the surety to payment of the final estimate;
- (2) The Contractor's Affidavit in the form required by Section 44.

In case the Affidavit or consent is not furnished, the City may retain out of any amount due the Contractor, sums sufficient to cover all lienable claims.

The making and acceptance of the final payment shall constitute a waiver of all claims by the City except those arising from:

- (1) unsettled liens;
- (2) faulty work appearing within 12 months after final payment;
- (3) hidden defects in meeting the requirements of the plans and specifications;
- (4) manufacturer's guarantees.

It shall also constitute a waiver of all claims by the Contractor, except those previously made and still unsettled.

## **Section 20 - Suspension of Work**

The City may at any time suspend the work, or any part by giving 5 days notice to the Contractor in writing. The work shall be resumed by the Contractor within 10 days after the date fixed in the

written notice from the City to the Contractor to do so. The City shall reimburse the Contractor for expense incurred by the Contractor in connection with the work under this Contract as a result of the suspension.

If the work, or any part, shall be stopped by the notice in writing, and if the City does not give notice in writing to the Contractor to resume work at a date within 90 days of the date fixed in the written notice to suspend, then the Contractor may abandon that portion of the work suspended and will be entitled to the estimates and payments for all work done on the portions abandoned, if any, plus 10% of the value of the work abandoned, to compensate for loss of overhead, plant expense, and anticipated profit.

## **Section 21 - Delays and the City's Right to Terminate Contract**

If the Contractor refuses or fails to prosecute the work, or any separate part of it, with the diligence required to insure completion, ready for operation, within the allowable number of consecutive calendar days specified plus extensions, or fails to complete the work within the required time, the City may, by written notice to the Contractor, terminate its right to proceed with the work or any part of the work as to which there has been delay. After providing the notice the City may take over the work and prosecute it to completion, by contract or otherwise, and the Contractor and its sureties shall be liable to the City for any excess cost to the City. If the Contractor's right to proceed is terminated, the City may take possession of and utilize in completing the work, any materials, appliances and plant as may be on the site of the work and useful for completing the work. The right of the Contractor to proceed shall not be terminated or the Contractor charged with liquidated damages where an extension of time is granted under Extension of Time - Section 14.

If the Contractor is adjudged a bankrupt, or if it makes a general assignment for the benefit of creditors, or if a receiver is appointed on account of its insolvency, or if it persistently or repeatedly refuses or fails except in cases for which extension of time is provided, to supply enough properly skilled workers or proper materials, or if it fails to make prompt payments to subcontractors or for material or labor, or persistently disregards laws, ordinances or the instructions of the Supervising Professional, or otherwise is guilty of a substantial violation of any provision of the Contract, then the City, upon the certificate of the Supervising Professional that sufficient cause exists to justify such action, may, without prejudice to any other right or remedy and after giving the Contractor 3 days written notice, terminate this Contract. The City may then take possession of the premises and of all materials, tools and appliances thereon and without prejudice to any other remedy it may have, make good the deficiencies or finish the work by whatever method it may deem expedient, and deduct the cost from the payment due the Contractor. The Contractor shall not be entitled to receive any further payment until the work is finished. If the expense of finishing the work, including compensation for additional managerial and administrative services exceeds the unpaid balance of the Contract Sum, the Contractor and its surety are liable to the City for any excess cost incurred. The expense incurred by the City, and the damage incurred through the Contractor's default, shall be certified by the Supervising Professional.

## **Section 22 - Contractor's Right to Terminate Contract**

If the work should be stopped under an order of any court, or other public authority, for a period of 3 months, through no act or fault of the Contractor or of anyone employed by it, then the Contractor may, upon 7 days written notice to the City, terminate this Contract and recover from the City payment for all acceptable work executed plus reasonable profit.

## **Section 23 - City's Right To Do Work**

If the Contractor should neglect to prosecute the work properly or fail to perform any provision of this Contract, the City, 3 days after giving written notice to the Contractor and its surety may, without prejudice to any other remedy the City may have, make good the deficiencies and may deduct the cost from the payment due to the Contractor.

## **Section 24 - Removal of Equipment and Supplies**

In case of termination of this Contract before completion, from any or no cause, the Contractor, if notified to do so by the City, shall promptly remove any part or all of its equipment and supplies from the property of the City, failing which the City shall have the right to remove the equipment and supplies at the expense of the Contractor.

The removed equipment and supplies may be stored by the City and, if all costs of removal and storage are not paid by the Contractor within 10 days of invoicing, the City upon 10 days written notice may sell the equipment and supplies at auction or private sale, and shall pay the Contractor the net proceeds after deducting all costs and expenses that should have been borne by the Contractor and after deducting all amounts claimed due by any lien holder of the equipment or supplies.

## **Section 25 - Responsibility for Work and Warranties**

The Contractor assumes full responsibility for any and all materials and equipment used in the construction of the work and may not make claims against the City for damages to materials and equipment from any cause except negligence or willful act of the City. Until its final acceptance, the Contractor shall be responsible for damage to or destruction of the project (except for any part covered by Partial Completion and Acceptance - Section 26). The Contractor shall make good all work damaged or destroyed before acceptance. All risk of loss remains with the Contractor until final acceptance of the work (Section 19) or partial acceptance (Section 26). The Contractor is advised to investigate obtaining its own builders risk insurance.

The Contractor shall guarantee the quality of the work for a period of one year. The Contractor shall also unconditionally guarantee the quality of all equipment and materials that are furnished and installed under the contract for a period of one year. At the end of one year after the Contractor's receipt of final payment, the complete work, including equipment and materials furnished and installed under the contract, shall be inspected by the Contractor and the Supervising Professional. Any defects shall be corrected by the Contractor at its expense as soon as practicable but in all cases within 60 days. Any defects that are identified prior to the end of one year shall also be inspected by the Contractor and the Supervising Professional and shall be corrected by the Contractor at its expense as soon as practicable but in all cases within 60 days. The Contractor shall assign all manufacturer or material supplier warranties to the City prior to final payment. The assignment shall not relieve the Contractor of its obligations under this paragraph to correct defects.

## **Section 26 - Partial Completion and Acceptance**

If at any time prior to the issuance of the final certificate referred to in Acceptance and Final Payment - Section 19, any portion of the permanent construction has been satisfactorily completed, and if the Supervising Professional determines that portion of the permanent construction is not required for the operations of the Contractor but is needed by the City, the Supervising Professional shall issue to the Contractor a certificate of partial completion, and immediately the City may take over and use the portion of the permanent construction described in the certificate, and exclude the Contractor from that portion.

The issuance of a certificate of partial completion shall not constitute an extension of the Contractor's time to complete the portion of the permanent construction to which it relates if the Contractor has failed to complete it in accordance with the terms of this Contract. The issuance of the certificate shall not release the Contractor or its sureties from any obligations under this Contract including bonds.

If prior use increases the cost of, or delays the work, the Contractor shall be entitled to extra compensation, or extension of time, or both, as the Supervising Professional may determine.

## **Section 27 - Payments Withheld Prior to Final Acceptance of Work**

The City may withhold or, on account of subsequently discovered evidence, nullify the whole or part of any certificate to the extent reasonably appropriate to protect the City from loss on account of:

- (1) Defective work not remedied;
- (2) Claims filed or reasonable evidence indicating probable filing of claims by other parties against the Contractor;
- (3) Failure of the Contractor to make payments properly to subcontractors or for material or labor;
- (4) Damage to another Contractor.

When the above grounds are removed or the Contractor provides a Surety Bond satisfactory to the City which will protect the City in the amount withheld, payment shall be made for amounts withheld under this section.

## **Section 28 - Contractor's Insurance**

- (1) The Contractor shall procure and maintain during the life of this Contract, including the guarantee period and during any warranty work, such insurance policies, including those set forth below, as will protect itself and the City from all claims for bodily injuries, death or property damage that may arise under this Contract; whether the act(s) or omission(s) giving rise to the claim were made by the Contractor, any subcontractor, or anyone employed by them directly or indirectly. Prior to commencement of any work under this contract, Contractor shall provide to the City documentation satisfactory to the City, through City-approved means (currently myCOI), demonstrating it has obtained the required policies and endorsements. The certificates of insurance endorsements and/or copies of



policy language shall document that the Contractor satisfies the following minimum requirements. Contractor shall add registration@mycoitracking.com to its safe sender's list so that it will receive necessary communication from myCOI. When requested, Contractor shall provide the same documentation for its subcontractor(s) (if any).

Required insurance policies include:

- (a) Worker's Compensation Insurance in accordance with all applicable state and federal statutes. Further, Employers Liability Coverage shall be obtained in the following minimum amounts:

- Bodily Injury by Accident - \$500,000 each accident
  - Bodily Injury by Disease - \$500,000 each employee
  - Bodily Injury by Disease - \$500,000 each policy limit

- (b) Commercial General Liability Insurance equivalent to, as a minimum, Insurance Services Office form CG 00 01 04 13 or current equivalent. The City of Ann Arbor shall be named as an additional insured. There shall be no added exclusions or limiting endorsements specifically for the following coverages: Products and Completed Operations, Explosion, Collapse and Underground coverage or Pollution. Further there shall be no added exclusions or limiting endorsements that diminish the City's protections as an additional insured under the policy. The following minimum limits of liability are required:

- \$1,000,000 Each occurrence as respect Bodily Injury Liability or Property Damage Liability, or both combined.
  - \$2,000,000 Per Project General Aggregate
  - \$1,000,000 Personal and Advertising Injury
  - \$2,000,000 Products and Completed Operations Aggregate, which, notwithstanding anything to the contrary herein, shall be maintained for three years from the date the Project is completed.

- (c) Motor Vehicle Liability Insurance, including Michigan No-Fault Coverages, equivalent to, as a minimum, Insurance Services Office form CA 00 01 10 13 or current equivalent. Coverage shall include all owned vehicles, all non-owned vehicles and all hired vehicles. The City of Ann Arbor shall be named as an additional insured. There shall be no added exclusions or limiting endorsements that diminish the City's protections as an additional insured under the policy. Further, the limits of liability shall be \$1,000,000 for each occurrence as respects Bodily Injury Liability or Property Damage Liability, or both combined.

- (d) Umbrella/Excess Liability Insurance shall be provided to apply excess of the Commercial General Liability, Employers Liability and the Motor Vehicle coverage enumerated above, for each occurrence and for aggregate in the amount of \$1,000,000.

- (2) Insurance required under subsection (1)(b) and (1)(c) above shall be considered primary as respects any other valid or collectible insurance that the City may possess, including any self-insured retentions the City may have; and any other insurance the City does possess shall be considered excess insurance only and shall not be required to contribute

with this insurance. Further, the Contractor agrees to waive any right of recovery by its insurer against the City for any insurance listed herein.

- (3) Insurance companies and policy forms are subject to approval of the City Attorney, which approval shall not be unreasonably withheld. Documentation must provide and demonstrate an unconditional and un-qualified 30-day written notice of cancellation in favor of the City of Ann Arbor. Further, the documentation must explicitly state the following: (a) the policy number(s); name of insurance company(s); name and address of the agent(s) or authorized representative(s); name(s), email address(es), and address of insured; project name; policy expiration date; and specific coverage amounts; (b) any deductibles or self-insured retentions which may be approved by the City, in its sole discretion; (c) that the policy conforms to the requirements specified Contractor shall furnish the City with satisfactory certificates of insurance and endorsements prior to commencement of any work. Upon request, the Contractor shall provide within 30 days a copy of the policy(ies) and all required endorsements to the City. If any of the above coverages expire by their terms during the term of this Contract, the Contractor shall deliver proof of renewal and/or new policies and endorsements to the Administering Service Area/Unit at least ten days prior to the expiration date.
- (4) Any Insurance provider of Contractor shall be authorized to do business in the State of Michigan and shall carry and maintain a minimum rating assigned by A.M. Best & Company's Key Rating Guide of "A-" Overall and a minimum Financial Size Category of "V". Insurance policies and certificates issued by non-authorized insurance companies are not acceptable unless approved in writing by the City.
- (5) City reserves the right to require additional coverage and/or coverage amounts as may be included from time to time in the Detailed Specifications for the Project.
- (6) The provisions of General Condition 28 shall survive the expiration or earlier termination of this contract for any reason.

## **Section 29 - Surety Bonds**

Bonds will be required from the successful bidder as follows:

- (1) A Performance Bond to the City of Ann Arbor for the amount of the bid(s) accepted;
- (2) A Labor and Material Bond to the City of Ann Arbor for the amount of the bid(s) accepted.

Bonds shall be executed on forms supplied by the City in a manner and by a Surety Company authorized to transact business in Michigan and satisfactory to the City Attorney.

## **Section 30 - Damage Claims**

The Contractor shall be held responsible for all damages to property of the City or others, caused by or resulting from the negligence of the Contractor, its employees, or agents during the progress of or connected with the prosecution of the work, whether within the limits of the work or elsewhere. The Contractor must restore all property injured including sidewalks, curbing, sodding, pipes, conduit, sewers or other public or private property to not less than its original condition with new work.

## **Section 31 - Refusal to Obey Instructions**

If the Contractor refuses to obey the instructions of the Supervising Professional, the Supervising Professional shall withdraw inspection from the work, and no payments will be made for work performed thereafter nor may work be performed thereafter until the Supervising Professional shall have again authorized the work to proceed.

## **Section 32 - Assignment**

Neither party to the Contract shall assign the Contract without the written consent of the other. The Contractor may assign any monies due to it to a third party acceptable to the City.

## **Section 33 - Rights of Various Interests**

Whenever work being done by the City's forces or by other contractors is contiguous to work covered by this Contract, the respective rights of the various interests involved shall be established by the Supervising Professional, to secure the completion of the various portions of the work in general harmony.

The Contractor is responsible to coordinate all aspects of the work, including coordination of, and with, utility companies and other contractors whose work impacts this project.

## **Section 34 - Subcontracts**

The Contractor shall not award any work to any subcontractor without prior written approval of the City. The approval will not be given until the Contractor submits to the City a written statement concerning the proposed award to the subcontractor. The statement shall contain all information the City may require.

The Contractor shall be as fully responsible to the City for the acts and omissions of its subcontractors, and of persons either directly or indirectly employed by them, as it is for the acts and omissions of persons directly employed by it.

The Contractor shall cause appropriate provisions to be inserted in all subcontracts relative to the work to bind subcontractors to the Contractor by the terms of the General Conditions and all other contract documents applicable to the work of the subcontractors and to give the Contractor the same power to terminate any subcontract that the City may exercise over the Contractor under any provision of the contract documents.

Nothing contained in the contract documents shall create any contractual relation between any subcontractor and the City.

## **Section 35 - Supervising Professional's Status**

The Supervising Professional has the right to inspect any or all work. The Supervising Professional has authority to stop the work whenever stoppage may be appropriate to insure the proper execution of the Contract. The Supervising Professional has the authority to reject all work and materials which do not conform to the Contract and to decide questions which arise in the execution of the work.

The Supervising Professional shall make all measurements and determinations of quantities. Those measurements and determinations are final and conclusive between the parties.

## **Section 36 - Supervising Professional's Decisions**

The Supervising Professional shall, within a reasonable time after their presentation to the Supervising Professional, make decisions in writing on all claims of the City or the Contractor and on all other matters relating to the execution and progress of the work or the interpretation of the contract documents.

## **Section 37 - Storing Materials and Supplies**

Materials and supplies may be stored at the site of the work at locations agreeable to the City unless specific exception is listed elsewhere in these documents. Ample way for foot traffic and drainage must be provided, and gutters must, at all times, be kept free from obstruction. Traffic on streets shall be interfered with as little as possible. The Contractor may not enter or occupy with agents, employees, tools, or material any private property without first obtaining written permission from its owner. A copy of the permission shall be furnished to the Supervising Professional.

## **Section 38 - Lands for Work**

The Contractor shall provide, at its own expense and without liability to the City, any additional land and access that may be required for temporary construction facilities or for storage of materials.

## **Section 39 - Cleaning Up**

The Contractor shall, as directed by the Supervising Professional, remove at its own expense from the City's property and from all public and private property all temporary structures, rubbish and waste materials resulting from its operations unless otherwise specifically approved, in writing, by the Supervising Professional.

## **Section 40 - Salvage**

The Supervising Professional may designate for salvage any materials from existing structures or underground services. Materials so designated remain City property and shall be transported or stored at a location as the Supervising Professional may direct.

## **Section 41 - Night, Saturday or Sunday Work**

No night or Sunday work (without prior written City approval) will be permitted except in the case of an emergency and then only to the extent absolutely necessary. The City may allow night work which, in the opinion of the Supervising Professional, can be satisfactorily performed at night. Night work is any work between 8:00 p.m. and 7:00 a.m. No Saturday work will be permitted unless the Contractor gives the Supervising Professional at least 48 hours but not more than 5 days notice of the Contractor's intention to work the upcoming Saturday.

## **Section 42 - Sales Taxes**

Under State law the City is exempt from the assessment of State Sales Tax on its direct purchases. Contractors who acquire materials, equipment, supplies, etc. for incorporation in City projects are not likewise exempt. State Law shall prevail. The Bidder shall familiarize itself with the State Law and prepare its Bid accordingly. No extra payment will be allowed under this Contract for failure of the Contractor to make proper allowance in this bid for taxes it must pay.

## Section 43

### CONTRACTOR'S DECLARATION

I hereby declare that I have not, during the period \_\_\_\_\_, 20\_\_\_, to \_\_\_\_\_, 20\_\_\_, performed any work, furnished any materials, sustained any loss, damage or delay, or otherwise done anything in addition to the regular items (or executed change orders) set forth in the Contract titled \_\_\_\_\_, for which I shall ask, demand, sue for, or claim compensation or extension of time from the City, except as I hereby make claim for additional compensation or extension of time as set forth on the attached itemized statement. I further declare that I have paid all payroll obligations related to this Contract that have become due during the above period and that all invoices related to this Contract received more than 30 days prior to this declaration have been paid in full except as listed below.

There is/is not (Contractor please circle one and strike one as appropriate) an itemized statement attached regarding a request for additional compensation or extension of time.

\_\_\_\_\_  
Contractor

\_\_\_\_\_  
Date

By \_\_\_\_\_  
(Signature)

Its \_\_\_\_\_  
(Title of Office)

Past due invoices, if any, are listed below.



## **STANDARD SPECIFICATIONS**

All work under this contract shall be performed in accordance with the Public Services Department Standard Specifications in effect at the date of availability of the contract documents stipulated in the Bid. All work under this Contract which is not included in these Standard Specifications, or which is performed using modifications to these Standard Specifications, shall be performed in accordance with the Detailed Specifications included in these contract documents.

Standard Specifications are available online:

<http://www.a2gov.org/departments/engineering/Pages/Engineering-and-Contractor-Resources.aspx>



## **DETAILED SPECIFICATIONS**

DETAILED  
SPECIFICATION  
FOR  
**COORDINATION AND COOPERATION  
WITH OTHERS AND  
WORK BY  
OTHERS**

The Contractor is reminded as to the requirements of article 104.08 of the 2020 edition of the MDOT Standard Specifications, "Cooperation by the Contractor."

The Contractor shall directly coordinate his/her work with the City of Ann Arbor.

The Contractor is hereby notified that the City of Ann Arbor Signs and Signals Unit will be installing signage along the project corridor near the end of the construction sequence.

No additional compensation will be paid to the Contractor, and no adjustments to contract unit prices will be made, due to delays and/or the failure of others in the performance of their work, nor for delays due to the encountering of existing utilities that are, or are not, shown on the Plans.

The Utility Owners who may have overhead and/or underground facilities located within the Right- of-Way include, but are not limited to:

DTE Energy – Gas  
3150 E. Michigan Ave  
Ypsilanti Township, MI 48198  
Contact:  
Darryl Ellington 313-995-6078  
Zach White 313-405-6024

ATT – Phone  
550 South Maple Road  
Ann Arbor, MI 48103  
Contact:  
Mike Jarema 734-277-7855  
Toya Troupe 734-996-2167

DTE Energy – Electric  
Western Wayne Service Center  
8001 Haggerty Road  
Belleville, MI 48111  
Contact: Anthony Ignasiak 734-397-4112

Comcast - Cable  
27800 Franklin Road  
Southfield, MI 48034  
Contact: Ron Sutherland 313-999-8300

MCI/Verizon – Fiber Optic  
2800 North Glenfille Road  
Richardson, TX 75082  
Contact: Dean Boyers 972-729-6016  
Contact: Marlon Redd  
marlon.redd@verizon.com

City of Ann Arbor  
4251 Stone School Road  
Ann Arbor, MI 48108  
Contact 734-794-6350:  
Dan Wooden – Water  
Travis Conley – Sanitary  
Kevin Schneider - Storm  
Matt Waldsmith - Forestry  
Contact 734-794-6361  
Marc Moreno – Signs & Signals

Consumers Energy  
1000 Grand Oaks Dr.  
Howell, MI 48843  
Contact: Bob McLachlan 517-242-7878

Lumen  
19675 W 10 Mile Road  
Southfield, MI 48075  
Contact: Dave Huckfeldt 517-812-2592

DTE Energy – Street Lighting  
8001 Haggerty Road  
Bellville, MI 48111  
Contact: Lance Alley 734-397-4188

Fiberlink, Inc  
PO Box 701  
Lapeer, MI 48446  
Contact:  
Tina Snoblen (810) 667-2891 ext. 307

Windstream- Fiber Optics  
1295 S Linbden Road, Suite B  
Flint, MI 48532  
Contact: Greg Serich 810-244-3500

University of Michigan  
1201 Kipke Drive, Room 1080  
Ann Arbor, MI 48109  
Contact: Terry Ramsey 734-647-2031

For protection of underground utilities, the Contractor shall call “MISS DIG” toll free at 1-800-482-7171 or call 811 a minimum of three (3) working days prior to excavation within the project limits. The Contractor must also notify utility owners who may not be part of the the “MISS DIG” system.

The Contractor shall notify the City of Ann Arbor a minimum of three (3) days prior to beginning construction.

The Owners of public or private utilities which will not interfere with the completed project and which do not present a hazard to the public or an extraordinary hazard to the Contractor's operations will not be required to move their facilities on or from the street right-of-way.

During the life of this contract other public authorities and utility companies may be performing work within or adjacent to the project limits, including, but not limited to; utility relocations and adjustments; traffic control; street maintenance; etc. The Contractor shall cooperate and coordinate construction activities with these agencies in accordance with Section 104.08 of the Michigan Department of Transportation 2020 Standard Specifications for Construction.

Stoppages created solely by the operations of the utility companies which delay utility revisions on any portion of this project may be considered as a basis of claim for an extension of time for project completion.

Costs for this work will not be paid for separately, but shall be included in the bid price of the Contract Item "General Conditions, Max \$400,000."

Existing Utilities, Site Features, and Investigations

The existing utilities vaults, structures, features, and site conditions above and underground are shown on the Contract Drawings from the best available information. These include, but are not limited to; pipelines, conduits, vaults, railroad foundations, and the like.

It is the Contractor's sole responsibility to perform its own site investigations and research and to incorporate in its bid sufficient amounts for all utilities coordination work. If any utilities, vaults, railroad bases, structures, features and/or site conditions are discovered or suspected by the Contractor to be different than shown on the plans, the Contractor is obligated to notify the Engineer immediately in writing so an addendum may be issued and/or the bid date may be revised.

The Contractor's submittal of a bid shall be considered prima facie evidence that it has reviewed all available information and performed all needed investigations and that its bid contains the needed resources to complete the project for the lump sum and unit prices contained herein.

Reference the Special Provision for "Extension of Time, Additional Compensation" for provisions regarding delays.

DETAILED  
SPECIFICATION  
FOR  
**DISPOSING OF EXCAVATED MATERIAL**

The Contractor shall dispose of, at the Contractor's expense, all excavated material. Costs for this work will not be paid for separately, but shall be included in the bid price of the Contract Item "General Conditions, Max \$400,000."

DETAILED  
SPECIFICATION  
FOR  
**INSURANCE  
REQUIREMENTS**

In addition to the insurance requirements noted in Section 28 of the General Conditions, Max \$400,000, the following agencies must be listed as additional insured:

DETAILED  
SPECIFICATION  
FOR  
**PROTECTION OF  
UTILITIES**

Damages to utilities by the Contractor's operations shall be repaired by the utility owner at the Contractor's expense.

Delays to the work due to utility repairs are the sole responsibility of the Contractor.

The Contractor shall keep construction debris out of utilities at all times. The Contractor shall be back charged an amount of \$50.00 per day for each manhole/inlet/utility pipe that contains construction debris caused as a result of the Contractor's (including subcontractors and suppliers) work.

The Contractor is solely responsible for any damages to the utilities or abutting properties due to construction debris.

Certain sanitary and storm sewers within the influence of construction may have been cleaned and videotaped prior to construction. The City may also choose to videotape utility line(s) during or after the work of this Contract to inspect them for damages and/or construction debris. If such inspection shows damage and/or debris, then all costs of such inspection, cleaning, repairs, and etc, shall be the Contractor's sole responsibility. If such inspection is negative, the City will be responsible for the costs of such inspection.

Costs for this work will not be paid for separately, but shall be included in the bid price of the Contract Item "General Conditions, Max \$400,000."

DETAILED  
SPECIFICATION  
FOR  
**SOIL EROSION  
CONTROL**

The Contractor shall maintain and remove soil erosion and sedimentation control measures, including but not limited to, fabric filters at all drainage structures, all in accordance with all applicable City (and other governmental agencies) codes and standards, as directed by the Engineer, Supervising Professional, as detailed in the Standard Specifications, and as shown on the Plans.

Costs for this work will not be paid for separately, but shall be included in the bid price of the Contract Item "General Conditions, Max \$400,000."

DETAILED  
SPECIFICATION  
FOR  
**VACUUM TYPE STREET AND UTILITY STRUCTURE  
CLEANING EQUIPMENT**

The Contractor shall furnish and operate throughout the construction period, vacuum type street cleaning and utility structure cleaning equipment (Vac-All, Vector, etc.) approved by the Engineer, as and when directed by the Engineer for dust control, for dirt/debris control, and for street cleaning immediately prior to, and for street and utility structure cleaning after any and all paving. The cleaning equipment shall be of sufficient power to remove dust, dirt, and debris from the pavement and from utility structures in and adjacent to the construction area.

Costs for this work will not be paid for separately, but shall be included in the bid price of the Contract Item "General Conditions, Max \$400,000."



DETAILED  
SPECIFICATION  
FOR  
**SITE CLEAN-UP**

Immediately after completion of construction, the Contractor shall clean the entire area within the influence of construction, including but not limited to all pavement, sidewalks, lawn areas, and underground utility structures, of all materials which may have accumulated prior to or during the construction.

Costs for this work will not be paid for separately, but shall be included in the bid price of the Contract Item "General Conditions, Max \$400,000."

DETAILED  
SPECIFICATION  
FOR  
**MATERIALS AND SUPPLIES CERTIFICATIONS**

The following materials and supplies shall be certified by the manufacturer or supplier as having been tested for compliance with the Specifications:

- HMA materials
- Hot-poured Joint Sealants
- Cements, coatings, admixtures and curing materials
- Sands and Aggregates
- Steel and Fabricated metal
- Portland Cement Concrete Mixtures Reinforcing Steel for Concrete
- Reinforcing Fibers for Concrete
- Pre-cast Concrete products
- Sanitary Sewer Pipe
- Storm Sewer Pipe
- Water Main Pipe and related materials
- Line Stop Materials
- Conduit
- Handholes
- Erosion Control Materials
- Corrugated Metal Pipe
- High Density Polyethylene Pipe
- Edge Drain and Underdrain Pipe
- Geotextile Filter Fabric and Stabilization Fabric/Grids
- Irrigation Meter Pit Materials
- Water Fountain Winterization Box Materials

The Contractor shall submit all certifications to the Engineer for review and approval a minimum of three business days prior to any scheduled delivery, installation, and/or construction of same.

Costs for this work will not be paid for separately, but shall be included in the bid price of the Contract Item "General Conditions, Max \$400,000."

DETAILED  
SPECIFICATION  
FOR  
**CONTRACT DRAWINGS/PLANS**

The Contractor shall carefully check and review all Drawings/Plans and advise the Engineer of any errors or omissions discovered. The Drawings/Plans may be supplemented by such additional Drawings/Plans and sketches as may be necessary or desirable as the work progresses. The Contractor shall perform all work shown on any additional or supplemental Drawings/Plans issued by the Engineer.

DETAILED  
SPECIFICATION  
FOR EXISTING  
**SOIL BORING AND PAVEMENT SECTION DATA**

Data pertaining to existing soil borings and pavement sections which may be included in these Contract Documents are provided to help the Engineer and Contractor determine the soil conditions existing within the construction area. The City in no way guarantees existing conditions to be the same as shown in the data. The Contractor is solely responsible for any and all conclusions he/she may draw from the data.

DETAILED  
SPECIFICATION  
FOR  
**WORKING IN THE  
RAIN**

The Contractor shall not work in the rain unless authorized in writing by the Engineer. The Engineer may delay or stop the work due to threatening weather conditions.

The Contractor shall not be compensated for unused materials or downtime due to rain, or the threat of rain.

The Contractor is solely responsible for repairing all damages to the work and to the site, including road infrastructures, road subgrades, and any adjacent properties, which are caused as a result of working in the rain.

DETAILED  
SPECIFICATION  
FOR  
**WORKING IN THE  
DARK**

The Contractor shall not work in the dark except as approved by the Engineer and only when lighting for night work is provided.

The Engineer may stop the work, or may require the Contractor to defer certain work to another day, if, in the Engineer's opinion, the work cannot be completed within the remaining daylight hours, or if inadequate daylight is present to either properly perform or inspect the work.

The Contractor will not be compensated for unused materials or downtime, when delays or work stoppages are directed by the Engineer for darkness and/or inadequate remaining daylight reasons.

The Contractor is solely responsible for repairing all damages to the work and to the site, including road infrastructures, road subgrades, and any adjacent properties, which are caused as a result of working in the dark.

**Exception:** During construction of the water main, the Contractor will be required, in some cases, to perform nighttime work when existing mains need to be shutdown to facilitate construction. Additional requirements regarding this work are contained elsewhere in the contract documents. The costs of night work, whether required by the Contract or requested by the Contractor, shall not be paid for separately, but shall be considered included in the cost of the affected contract items (pay items).

DETAILED  
SPECIFICATION  
FOR  
**QUANTITIES AND UNIT PRICES**

Quantities as given are approximate and are estimated for bidding purposes. Quantities are not guaranteed and may vary by any amount. While it is the City of Ann Arbor's intent to complete the project substantially as drawn and specified herein, quantities may be changed or reduced to zero for cost savings or other reasons. **The City of Ann Arbor reserves the right to change the quantities and no adjustment in unit price will be made for any change in any quantity.**

DETAILED  
SPECIFICATION  
FOR  
**GENERAL CONSTRUCTION NOTES**

The following notes pertain to all Plan sheets issued as part of this Contract, and these notes shall be considered part of each Plan sheet or Detailed Information Sheet.

1. All work shall conform to latest revision of the City Standard Specifications.
2. The Contractor shall maintain access to all drives throughout the course of construction. Drives shall never be closed during non-working hours, unless otherwise authorized in writing by the Engineer.
3. The Contractor shall completely restore all existing site features to better than, or equal to, their existing condition.
4. The Contractor shall be aware that there are above-ground and below-ground utilities existing in and on these streets which include, but are not limited to: gas mains and service leads; water mains and service leads; storm sewer mains and service leads; sanitary sewer mains and service leads; telephone poles, wires, cables and conduits; electrical poles, wires, cables and conduits; cable television wires, cables and conduits, building vaults and other various utilities. The Contractor shall conduct all of its work so as not to damage or alter in any way, any existing utility, except where specified on the Plans or where directed by the Engineer. The City has videotaped and cleaned all sanitary and storm sewers, including storm sewer inlet leads, and has found all of these facilities to be in good condition, with the exception of those shown on the Plans for repairs or replacement.
5. The Contractor is solely responsible for any delays, damages, costs and/or charges incurred due to and/or by reason of any utility, vaults, structure, feature and/or site condition, whether shown on the Plans or not, and the Contractor shall repair and/or replace, at its sole expense, to as good or better condition, any and all utilities, structures, features and/or site conditions which are impacted by reason of the work, or damaged by its operations, or damaged during the operations of its subcontractors or suppliers.
6. No extra payments or adjustments to unit prices will be made for damages, delays, costs and/or charges due to existing utilities, structures, features and/or site conditions not shown or being incorrectly shown or represented on the Plans.



7. The Contractor is solely responsible for furnishing the appropriate equipment and qualified personnel for the size and condition of the site and the requirements of the proposed work. Damage to buildings, amenities, utilities, paving, and facilities within and adjacent to the work area, and to work already performed by the Contractor shall be the responsibility of the Contractor to repair as needed, at no cost to the project.

DETAILED  
SPECIFICATION  
FOR  
**CONCRETE  
DURABILITY**

**DESCRIPTION**

The Contractor shall furnish a Portland cement concrete mixture for this project that has been tested under this specification and shown to be resistant to excessive expansion caused by alkali-silica reactivity (ASR) and provides adequate air entrainment for freeze thaw durability. The Contractor shall construct the project with practices outlined in this specification.

**MATERIALS**

Submit a job mix formula (JMF) to the Engineer for approval prior to concrete work commencing. The materials provided for use on this project shall conform to the following requirements:

Portland cement	ASTM C 150
Fine Aggregate	ASTM C 33*
Coarse Aggregate	ASTM C 33*
Fly Ash, Class F	ASTM C 618 Slag Cement, Grade 100, 120 ASTM C 989
Silica Fume	ASTM C 1240
Blended Cements	ASTM C-595 Air Entraining Admixtures ASTM C-260
Chemical Admixtures	ASTM C-494
White Membrane Cure	ASTM C-309 Type 2

\* Fine and coarse aggregates shall consist of natural aggregates as defined in the 2020 MDOT Standard Specifications Section 902.02.A.

The Contractor shall provide documentation that all materials to be incorporated into proposed mixed designs meet the requirements of this section.

**Portland Cement**

Furnish Type IL Portland cement in accordance with section 901 of the MDOT Standard Specifications for Construction meeting the chemical and physical requirements specified in ASTM C595/C595M, Standard Specifications for Blended Hydraulic Cements. Ensure the Type IL Portland cement proposed for substitution is from the same Approved Manufacturer as

the Type I Portland cement in the approved JMF.

At least 7 days prior to concrete production, the concrete producer must provide test data (specified below) generated from a four cubic yard (minimum) trial batch of concrete using Type IL Portland cement for the Engineer's review and approval. The trial batch must represent a current approved JMF for either a standard MDOT Grade 3500, Grade 3500HP, Grade 4500, or Grade 4500HP concrete mixture produced using Type I Portland cement, as described in section 1004 of the Standard Specifications for Construction. Ensure the materials and mixture proportions for the Type IL JMF are the same as those documented in the above-mentioned JMF using Type I Portland cement. Minor adjustments to chemical admixture dosages are permitted in efforts to achieve the specified fresh concrete properties.

Trial batch compliance for applications other than Portland cement concrete mixtures will be in accordance with the contract.

The Engineer will review the trial batch test data to determine if the fresh and hardened concrete properties of the Type IL JMF meet specification requirements for the respective MDOT Grade of concrete represented by the trial batch. If the Engineer determines that the trial batch test data are in conformance with specification requirements, then the Type IL Portland cement will be permitted to be substituted in lieu of the Type I Portland cement for all approved concrete mixtures generated at the concrete production facility for the project. If the Engineer determines that the trial batch test data do not meet specification requirements for the respective MDOT Grade of concrete, the Contractor will not be permitted to substitute Type IL Portland cement in lieu of Type I Portland cement. Mix design and JMF documentation for concrete mixtures using Type IL Portland cement will then be required in accordance with subsection 1003.03.C of the Standard Specifications for Construction or the contract, where applicable.

Once Type IL Portland cement is approved for use on the project, reinstatement of Type I Portland cement into the JMF is not permitted. Substitution of other material types or sources, including admixtures, as documented in the initial Type I JMF is not permitted.

#### Alkali-Silica Reactivity

The Contractor shall supply to the Engineer preliminary concrete mix designs including a list and location of all suppliers of concrete materials. The Contractor shall evaluate the mixtures for the potential for excessive expansion caused by ASR and provide documentation to the Engineer. The Contractor's evaluation shall include a review of any previous testing of the material sources intended to be used for both the fine and coarse aggregates for the concrete mixtures. The previous testing may be from other projects or

records provided by the material suppliers.

Aggregates shall be tested under ASTM C-1260. If the expansion of the mortar bars is less than 0.10%, at 14 days, the aggregates shall be considered innocuous and there are no restrictions for ASR mitigation required with this material.

Previous aggregate test data may be used. If no previous test data is available, for the concrete mix, that shows that it is resistant to ASR, a concrete mixture that will mitigate the potential for ASR must be designed using either method 1 or 2 as described below.

**Method 1.** Substitution of a portion of the cement with Class F Fly Ash, Slag Cement Grade 100 or 120 or a ternary mix (blended cement) containing a blend of Portland cement and slag cement, or Class F fly ash, or silica fume.

The maximum substitution of cement with the fly ash permitted shall be 25% by weight of total cementitious material (cement plus fly ash). Additional requirements for the Fly Ash, Class F are that the Calcium Oxide (CaO) percent shall be less than 10 % and the available alkalis shall not exceed a maximum of 1.5%. A copy of the most recent mill test report shall be submitted to verify. Note: a Class C fly ash with a minimum total oxides ( $\text{SiO}_2 + \text{Al}_2\text{O}_3 + \text{Fe}_2\text{O}_3$ ) of 66% and a minimum  $\text{SiO}_2$  of 38% may be used in lieu of Type F fly ash.

The maximum substitution of cement with the Slag Cement permitted shall be 40% by weight of total cementitious material (cement plus Slag Cement). The minimum replacement rate with Slag Cement shall be 25%.

For a ternary blend the total replacement of supplementary cementitious materials is 40% with a blend consisting of a maximum of 15% type F fly ash, and/or 8% silica fume and/or slag cement.

For method 1, the effectiveness of the proposed mix combination to resist the potential for excessive expansion caused by ASR shall be demonstrated using current or historic data. To demonstrate the effectiveness of the proposed mix the Contractor shall construct and test mortar bars per ASTM C1567 (14 day test) using both the fine and coarse aggregate along with the proposed cementitious material for the concrete mixture. If a mortar bar constructed of these materials produces an expansion of less than 0.10%, concrete mixture will be considered to be resistant to excessive expansion due to ASR.

If a mortar bar constructed produces an expansion of 0.10% or greater, concrete mixtures containing these materials shall not be considered resistant to the potential for excessive expansion due to ASR and shall be rejected. Additional testing, including alternate proportions or different materials will be required.

**Method 2.** Use low alkali cement and maintain the total alkali content from the cementitious at no more than 3.0 lbs/cyd (Na<sub>2</sub>Oeq). The total alkali contribution is calculated by the quantity contained in the Portland cement only.

Requirements for Low Alkali Cement are that the alkali content does not exceed 0.60% expressed as Na<sub>2</sub>O equivalent. Equivalent sodium oxide is calculated as: (percent Na<sub>2</sub>O + 0.658 x percent K<sub>2</sub>O).

For either method 1 or 2, if the Contractor intends to change any component material supplied after the mix design has been approved all concrete work will be suspended with no cost to the project or extensions of time, unless approved, until evaluation of the new mixtures and testing of the new materials demonstrates that it is resistant to excessive expansion due to ASR.

The Engineer and Contractor shall monitor the concrete that is delivered to the project site so as to insure that the approved mix design is being followed. The supplier shall include on the delivery ticket for each batch of concrete delivered to the job, the identification and proportions of each material batched.

When concrete is placed during cold weather, defined for the purposes of this Detailed Specification to be, air temperatures below 40° F, the use of accelerators, heated aggregates, silica fume and/or additional forms of cold weather protection will be required. Cold weather will not eliminate the requirement for furnishing and placing a concrete mix that is considered resistant to ASR attack.

Prior to cool weather placement, defined for the purposes of this detailed specification to be, air temperatures between 40° and 60° F, the set time of the proposed mix shall be verified under anticipated field conditions. This information shall be used when scheduling pours and saw crews.

### Air Entrainment

Air entrainment shall be accomplished by addition of an approved air entraining agent. Air content as determined by ASTM C 231 or ASTM C 173, shall be determined on each day of production as early and as frequently as necessary until the air content is consistently acceptable. If during the period of time while adjustments are being made to the concrete to create a mixture

that is consistently acceptable, concrete is produced that does not meet the requirements of this Detailed Specification, the Engineer may reject the material and direct it to be removed from the jobsite. Any rejected material shall be removed from the jobsite at the Contractor's sole expense. Quality Control testing performed by the Contractor to ensure compliance with the project specifications shall be performed on the grade ahead of the placement operation.

**Paver placement:** During production, the plastic concrete material shall be tested for acceptance at a point ahead of the paver. The air content of the concrete mixture that the Contractor shall provide shall be known as the Acceptance Air Content (AAC). The Contractor shall also provide additional entrained air in the concrete mixture to account for the air loss which occurs in the concrete mixture experienced during transportation, consolidation and placement of the concrete. The "air loss" shall be added to the air content of the concrete mixture as established on the approved concrete mix design. The AAC for the project will be 6.0% plus an amount equal to the airloss.

For up to the first four loads, the air content measured on-site prior to placement shall be at least 8.0% and no more than 12.0%. To establish the initial AAC on the first day of paving, the air content of the first load shall be tested at the plant. After initial testing at the plant the Contractor shall provide at least two sample sets to determine the actual air loss during placement. A sample set shall consist of two samples of concrete from the same batch, one taken at the point of discharge and the other from the in-place concrete behind the paver. The air loss from the two sample sets shall be averaged and added to 6.0% to establish the AAC (rounded to the next higher 0.5%). After the testing and adjustment procedure(s) have been completed, the project acceptance air tests shall be taken prior to placement. The Contractor shall provide concrete to the jobsite that has an air content of plus 2.0%, or minus 1.0%, of the AAC.

After the AAC has been established, it shall be verified and/or adjusted through daily checks of the air loss through the paver. The Contractor shall check the air loss through the paver a minimum of two times a day. A Revised AAC shall be required to be established by the Contractor if the average air loss from two consecutive tests deviates by more than 0.5% from the current accepted air loss. The testing operations performed by the Contractor to establish a revised AAC shall be performed to the satisfaction of the Engineer. The Contractor shall be solely responsible for any delays and/or costs that occur to the project while establishing revised AACs.

**Hand placed concrete:** The air content for non-slip-form paving shall be 7.0% plus 1.5%, or minus 1.0%, at the point of placement.

## **CONSTRUCTION METHODS**

### **Aggregate Control**

**Gradation control** – The supplier shall provide a detailed stockpile management plan, describing their process control procedure for shipping, handling, and stockpiling of each aggregate including workforce training.

**Moisture control** – All aggregate materials must be conditioned to a moisture content of not less than saturated surface dry (SSD) prior to batching. A watering process using an effective sprinkler system designed and operated by the Contractor shall be required on all coarse aggregate material stockpiles.

The Contractor shall provide verification that these processes have been performed by the supplier. The Engineer reserves the right to independently verify that the supplier has complied with these standards.

### **Mixing**

**Central mix plants** - The total volume of the batch shall not exceed the designated size of the mixer or the rated capacity as shown on the manufacturer's rating plate.

**Drum Mix Plants:** After all solid materials are assembled in the mixer drum; the mixing time shall be a minimum of 60 seconds and a maximum of 5 minutes. The mixing time may be decreased if the ASTM C-94 11.3.3 mixer efficiency tests show that the concrete mixing is satisfactory. The Engineer may require an increase in the minimum mix time if the mixer efficiency test determines that the concrete is not being mixed satisfactorily. The minimum mixing time shall start after the mixer is fully charged. Mixers shall be operated at the speed recommended by the manufacturer as mixing speed. The mixer shall be charged so that a uniform blend of materials reached the mixer throughout the charging cycle. Any additional slump water required shall be added to the mixing chamber by the end of the first 25% of the specified mixing time. Mixers shall not be used if the drum is not clean or if the mixing blades are damaged or badly worn

**Ribbon mixers:** After all solid materials are assembled in the mixer; the mixing time shall be a minimum of 30 seconds and a maximum of 2.5 minutes. The mixing time may be decreased if the ASTM C-94 11.3.3 mixer efficiency tests show that the concrete mixing is satisfactory. The Engineer may require an increase in the minimum mix time if the mixer efficiency test determines that the concrete is not being mixed satisfactorily. The minimum mixing time shall be indicated by an accurate

timing device which is automatically started when the mixer is fully charged. Mixers shall be operated at the speed recommended by the manufacturer as mixing speed. The mixer shall be charged so that a uniform blend of materials reached the mixer throughout the charging cycle. After any additional slump water is added to the mixing chamber the mixing shall continue for a minimum of 10 seconds. Mixers shall not be used if the mixer is not clean or if the mixing blades are damaged or badly worn.

**Truck Mixers** -The capacities and mixing capabilities shall be as defined in ASTM C 94, and each unit shall have an attached plate containing the information described therein. The plate may be issued by the Truck Mixer Manufacturer. The mixer capacity shall not be exceeded, and the mixing speeds shall be within the designated limits. Truck mixers shall be equipped with a reliable reset revolution counter. If truck mixers are used for mixing while in transit, the revolution counter shall register the number of revolutions at mixing speed.

An authorized representative of the concrete producer shall certify that the interior of the mixer drum is clean and reasonably free of hardened concrete, that the fins or paddles are not broken or worn excessively, that the other parts are in proper working order, and that the unit has been checked by the representative within the previous 30 calendar day period to substantiate this certification. The current, signed certification shall be with the unit at all times.

The required mixing shall be between 70 and 90 revolutions. The mixing shall be at the rate designated by the manufacturer and shall produce uniform, thoroughly mixed concrete.

The Engineer may inspect mixer units at any time to assure compliance with certification requirements, and removal of inspection ports may be required. Should the Engineer question the quality of mixing, the Engineer may check the slump variation within the batch. Should the slump variation between two samples taken, one after approximately 20% discharge and one after approximately 90% discharge of the batch, show a variation greater than 3/4 inch (20 mm) or 25% of the average of the two, whichever is greater, the Engineer may require the mixing to be increased, the batch size reduced, the charging procedure be modified or the unit removed from the work.

The practice of adding water on the site shall be discouraged. After the slump of the concrete in the first round of trucks has been adjusted on-site, the amount of water added at the plant shall be adjusted accordingly for that day's work. All additions of water on site shall be approved by the Engineer.



## Curing

Apply liquid curing compound in a fine atomized spray to form a continuous, uniform film on the horizontal surface, vertical edges, curbs and back of curbs immediately after the surface moisture has disappeared, but no later than 30 minutes after concrete placement. With approval of the Engineer, the timing of cure application may be adjusted due to varying weather conditions and concrete mix properties.

The cure system shall be on site and tested prior to concrete placement.

Apply a curing compound at a rate of application not less than 2 gallons per 25 square yards. The Contractor shall keep the material thoroughly mixed per the Manufacturer's recommendations. The curing compound shall not be diluted.

The finished product shall appear as a uniformly painted solid white surface. Areas exhibiting a blotchy or spotty appearance shall be recoated immediately.

## **COMPLIANCE WITH STANDARDS**

The Engineer will review and approve all material test reports and mix designs supplied by the Contractor before any placement of concrete. The Engineer will visually inspect the placed concrete and review the concrete test reports prior to final acceptance.

Acceptance sampling and testing will be performed using the sampling method and testing option selected by the Engineer. Acceptance testing will be performed at the frequency specified by the Engineer. Quality control measures to insure job control are the responsibility of the Contractor. The Engineer's testing and/or test results will not relieve the Contractor from his/her responsibilities to produce, deliver, and place concrete that meets all project requirements. The Engineer's test results are for acceptance purposes only.

If the results of the testing are not in compliance with the project specifications, the Engineer shall determine appropriate corrective action(s). Time extensions will not be granted to the Contractor during the time that the Engineer is determining the necessary corrective actions.

If, in the Engineer's judgment, the rejected material must be replaced, the material in question will be removed and replaced at the Contractor's sole expense. The removal costs will be deemed to include all relevant and associated costs including, but not limited to; re-mobilization, traffic control, re-grading the aggregate base course, if required, placement of material meeting the project specifications, and all other expenses. Time extensions

will not be granted to the Contractor for any required repair work to meet the requirements of this specification.

If the Engineer decides that the material in question can remain in place, an adjustment to the contract unit price(s) may be made of up to 100% of the bid price(s) for the affected items of work.

### **MEASUREMENT AND PAYMENT**

The cost associated with complying with the requirements as described herein, including any required remedial action(s), shall be included in the cost of other items of work and shall not be paid for separately.

DETAILED  
SPECIFICATION  
FOR  
**EXISTING IN SITU  
SOILS**

The Contractor shall be aware that soils within the City of Ann Arbor and Washtenaw County contain levels of naturally-occurring, regulated, elemental metals.

The City of Ann Arbor is unaware of any previous activities that would have contaminated the existing soils by a hazardous substance as a result of human activity.

In accordance with the applicable project requirements, all excavated material shall become the property of the Contractor. Any excavated material that cannot be incorporated into the project work, in accordance with the material requirements of the work being performed, must be properly disposed of off-site by the Contractor. Consequently, in-situ excavated soils that do not exhibit odors, discoloration, or other indications of contamination are not required to be disposed of in a landfill and may be disposed of by the Contractor by the method of their choice. The City of Ann Arbor suggests a disposal method that minimizes future human contact with the soil or the soil's contact with a water course or ground water sources. The Contractor shall ultimately be responsible for any disposal method they choose.

The Contractor's submittal of a bid for this project shall be considered prima facie evidence that they have considered these facts and have included all necessary resources to perform all work of this project and to properly dispose of excavated soils from this project off-site.

DETAILED  
SPECIFICATION  
FOR  
**WATER MAIN  
INSTALLATION AND  
TESTING**

1 of 3

**DESCRIPTION**

This Detailed Specification is intended to supplement the current City of Ann Arbor Standard Specifications for Construction with regard to water main installation and hydrologic and bacteriologic testing. It is also intended to establish minimum requirements for the work that the Contractor is responsible to follow.

**CONSTRUCTION METHODS**

During the delivery, handling, installation, and testing of the water main, the Contractor shall comply with the following requirements:

1. The Contractor shall dig-up and expose utility crossings 60-feet in advance of laying any water main pipe in their vicinity. This will allow the Engineer to adjust the grade of the water main, if possible, to avoid the existing utilities. The costs of the advance excavations, and related costs, shall be included in the respective items of work listed in the Bid Form. Some dig-ups may need to occur out of Phase.
2. Keep all pipes clean and neatly stacked a minimum of six-inches off of the ground at all times. Ends of pipe shall be covered to prevent entry of dust, dirt, small animals, and any other objectionable matter at all times. During installation of the water main and all appurtenances no dirt, soil, or non-potable water shall be allowed to enter the pipe. If dirt, soil, or non-potable water does enter the pipe, the Contractor shall completely remove it prior to installing the next segment of pipe. Segments of pipe that are have visible signs of contamination including, but not limited to; soil, dirt, mud, oil, grease, solvents, animal droppings, etc. shall have all visible traces of the offending substance completely removed by the Contractor in a manner acceptable to the Engineer. Sections of pipe or fittings that have been marked by the Engineer for cleaning shall not be approved for installation until such time as the Engineer has again approved them for use on the project. Acceptable methods of cleaning include flushing and/or power washing, compressed air, or other methods that the Engineer may approve. Approval by the Engineer of a cleaning method shall not be construed by the Contractor to include acceptance of the water main for the purposes of placing it into service. Water main pipe and fittings that have been placed shall remain covered on the advancing end until the next segment of pipe is connected. The Contractor may uncover no more than three segments of pipe in advance of placement. Water main pipe and fittings that have been laid out

further in advance of the installation operation must remain covered.

3. Gasket lubricant shall only be applied immediately before connection to the next segment of pipe. Pipe with lubricant applied shall not come in contact with the ground. If the lubricated portion of the pipe end contacts the ground, it shall be thoroughly cleaned to the satisfaction of the Engineer, prior to its installation.
4. All water mains shall be swabbed in accordance with the requirements of Section 3H, Flushing and Swabbing, of the current edition of the City of Ann Arbor Public Services Department Standards. During swabbing of the water main, the swab shall be flushed through the pipe in accordance with the manufacturer's recommendations and in a manner that is acceptable to the Engineer. The Contractor shall submit the product data of the swab from the manufacturer, for review and approval by the Engineer, at or before the pre-construction meeting.
5. Swabbing of the water main shall be followed immediately by flushing of the pipe so that any disturbed particles are washed out before they can resettle. The pipe shall be flushed in accordance with Section 3H, Flushing and Swabbing, of the current edition of the City of Ann Arbor Public Services Department Standard Specifications. The pipe shall be flushed until the water runs clear for a minimum of fifteen minutes or until two full pipe volumes have been flushed (whichever is longer.) Flushing from the existing water main that is to be replaced shall not be allowed.
6. During the chlorination process, the proper level of chlorination must be achieved throughout the entire length pipe. Chlorine levels shall be checked at intermediate locations as directed by the Engineer and the Contractor shall add chlorine until such time as the required levels are achieved at all points. The "slug method" of chlorinating the pipe shall not be allowed. The Contractor shall chlorinate the proposed water main to a minimum residual concentration of 100 parts per million with commercial liquid chlorine solution. The chlorine concentrate shall be a minimum of 10% chlorine (sodium hypochlorite) by volume. Solid chlorine "pellets" or powder shall not be allowed. Any chlorine containing compound used on the project shall be approved by the Engineer. The minimum recommended dosage of chlorine (sodium hypochlorite) is as follows (based on 10% available chlorine):

Recommended Minimum Chlorine Dosage to Disinfect 100 L.F. of Pipe

Pipe Diameter	10% Chlorine Solution (gallons)
6	0.306
8	0.544
10	0.852
12	1.226
16	2.180
20	3.406
24	4.904

7. Bacteriological testing shall be performed by the City with the Contractor present. The Engineer shall determine the number, location, and type of testing points for each section of water main being tested. Bacteriological samples shall only be drawn from copper or brass sampling points. The use of galvanized steel blow-offs or sampling points are strictly prohibited. Obtaining bacteriological samples from fire hydrants will not be allowed.
8. If a new water main fails two consecutive sets of bacteriological tests, the Engineer may require the Contractor to re-swab the water main in accordance with Section 3H, Flushing and Swabbing, as described above. Additional flushing, prior to subsequent bacteriological sampling will also be required. The required additional swabbing and flushing of the water main by the Contractor shall be performed at no additional cost to the City of Ann Arbor.

### **MEASUREMENT AND PAYMENT**

Payment for all labor, materials, and equipment that is required to comply with this Detailed Specification shall be considered as part of the unit price as bid for each respective water main pipe and fitting and will not be paid for separately.

Payment for all water main pipes shall be as follows:

The Contractor shall be paid for 50% of the water main pipe installed upon satisfactory completion of the installation and backfilling of the water main pipe. The remaining 50% shall be paid upon successful completion of all required bacteriological testing, the water main has been placed into service, and all water service leads have been connected and are in service.

DETAILED SPECIFICATION  
FOR  
**COORDINATION WITH EXISTING WATER SUPPLY SYSTEM**

The Contractor may not operate City water main valves. For valve operation, contact the City of Ann Arbor Public Services Area. It is recommended that the Contractor request that the existing valves, which will need to be operated in order to perform the water main work, are checked in advance of the work to ensure that they operate properly.

Several items of work on this project require coordination with the City of Ann Arbor Public Services Area (The City). The Contractor shall notify the City three (3) full working days in advance of any items requiring coordination with the City.

The Contractor shall complete the water main work in a manner which minimizes the disruption of water service. Water quality issues arise and treatment costs increase when the well field system is taken off line. No shut downs at the well field shall occur on Saturdays or Sundays. Shut downs shall not be for longer than 8.0 hours for any given shutdown event. Liquidated damages as detailed and described on page 9-10 and in the Detailed Specification for Progress Clause of these documents shall apply to any shut downs that occur on Saturday or Sunday or for a period of time longer than 8.0 hours in any given 24 hour period.

The Contractor shall be responsible for coordination with the City of Ann Arbor Public Services Area for the installation of 1-inch corporations in the gate wells to be used for testing and filling of new main. The Contractor shall pay the City of Ann Arbor's Field Operations Unit all costs associated with installing the corporations.

The Contractor must have all materials, fittings, pumps and other miscellaneous equipment, and personnel on site before the City of Ann Arbor Public Services Area personnel will prepare and shutdown an existing main.

---

DETAILED SPECIFICATION  
FOR  
**ASPHALTIC SEAL COATINGS DUCTILE IRON PIPE & FITTINGS**

All ductile iron pipe and fittings shall have an asphaltic seal coat on their cement-mortar linings. The coatings shall meet the requirements of ANSI/NSF Standard 61, Drinking Water System Components - Health Effects, and be approved for contact with drinking water.

**MEASUREMENT AND PAYMENT**

Asphaltic seal coat for ductile iron pipe and fittings shall not be measured or paid for separately. This work shall include all labor, materials and equipment costs necessary to provide asphaltic seal coat of ductile iron pipe and fittings. Payment for this work shall be considered as part of the unit price for each respective ductile iron pipe and fitting unit price.

DETAILED SPECIFICATION  
FOR  
**EXTENSION OF TIME, ADDITIONAL COMPENSATION**

AA:MGN  
WT:AJK:

1 of 1

01/27/16  
11/20/22

The Contractor shall notify the Engineer of their intent to submit a claim for additional compensation or an extension of time in accordance with the requirements of Section 104.10 of the Michigan Department of Transportation 2020 Standard Specification for Construction. Failure to do so may be a basis for not approving the request for additional compensation or extension of time. The notification will allow the Engineer an opportunity to influence, keep records and monitor the work.

Extensions of time will not be authorized due to delays caused by, or stemming from, the weather for the period between November 14<sup>th</sup> and April 16<sup>th</sup>. It is anticipated that the Contractor will perform all removals, remove materials off-site, and begin watermain installation prior to Seasonal Weight Restrictions (Michigan Frost Laws). It is also anticipated that the Contractor will make the necessary provisions in coordination with the Engineer to stockpile necessary materials and equipment on-site, and continue on-site work during the Seasonal Weight Restrictions (Michigan Frost Laws). An extension of time shall be granted for the number of days Seasonal Weight Restrictions are in effect beyond 21 days. No extension shall be allowed if Seasonal Weight Restrictions are in effect for 21 or fewer days .

The Contractor shall anticipate underground utility complications arising from the proposed utility work, unknown and/or fragile utilities, and utilities requiring investigation and or relocation. These utilities may be shown on the plans, correctly or incorrectly, or not at all, and may delay a controlling operation. Should this be the case, the delay caused to the controlling operation may be a basis for an extension of time.

Delays will not be considered as a basis for additional compensation on this project.

Additional compensation is defined as additional work, extra work, upward unit price adjustments, payments for down time, and the like.



DETAILED SPECIFICATION  
**SUSPENSION OF WORK  
AND  
SEASONAL LIMITATIONS**

NCI:AK  
WT:CGT

1 of 1

06/26/15  
11/20/22

It is the intent of the Engineer to allow certain construction operations to proceed during the customary period of seasonal suspension (between November 14<sup>th</sup> and April 16<sup>th</sup>) as described herein. These operations may include, but not be limited to; removals, underground utility construction, earthwork operations and concrete placement.

The Contractor will be allowed to begin/continue construction operations between November 14<sup>th</sup> and April 16<sup>th</sup> provided that the weather and temperature limitations as described in the 2020 MDOT Standard Specifications for Construction, Supplemental Specifications, and the Special Provisions for the individual construction operations are met. The Contractor shall anticipate that he/she may not be able to work during this entire period due to weather and temperature limitations. **No extension of time will be authorized due to delays resulting from temperature limitations or weather conditions, including, but not limited to; rain, freezing rain, snow, ice, low temperatures, and the like, occurring between November 14<sup>th</sup> and April 16<sup>th</sup>.**

Seasonal limitations as defined in Section 101 of the MDOT 2020 Standard Specification for Construction shall not apply to any work except for lawn, trees and all other plantings as provided for in the project Special Provisions. Where seasonal limitations will not apply, all weather, temperature, frost, and all other similar limitations/requirements will remain in full affect.

The suspension of lawn, tree or other planting work shall not be considered as a basis for a claim for an extension of time for the entire project, but shall only be considered as a basis for a claim for an extension of time for the completion the lawn, tree or other planting work. Should the contract be extended for the completion of lawn, tree or other planting work, the extension of time will not be a basis for determining the contract completion date for the purposes of determining any incentives, disincentives, liquidated damages or adjustments in other contract unit prices that otherwise may be allowed.

DETAILED SPECIFICATION  
**CITY OF ANN ARBOR SOIL EROSION AND SEDIMENTATION  
CONTROL/GRADING PERMIT REQUIREMENTS**

AA:MGN

1 of 1

02/06/14

The City of Ann Arbor has obtained a City of Ann Arbor Soil Erosion and Sedimentation Control/Grading Permit for the purposes of obtaining an NPDES Permit – Notice of Coverage for the subject project.

The Contractor shall be aware that this permit must be transferred into the name of the Prime Contractor prior to beginning any work on this project. The City of Ann Arbor will waive the fees for this permit. The Contractor shall coordinate with, and complete all necessary paperwork, for the City of Ann Arbor Planning and Building Services Unit for the procurement of the needed permit.

All costs associated with coordinating with the City of Ann Arbor to obtain the permit will not be paid for separately.

DETAILS SPECIFICATION  
FOR  
**LAND MONUMENTS, PROPERTY CORNERS, AND MARKERS**

AA:MGN

1 of 1

08/23/13

It shall be the Contractor's responsibility to take all necessary precautions not to disturb, move, or destroy any land monuments, property corners, or markers delineating the boundaries of property along or near the work.

The Contractor shall notify the Engineer of any land monuments, property corners, or markers that will be affected by the construction in sufficient time so that they may be properly protected or witnessed for later replacement by the Engineer.

Land monuments, property corners, or markers unnecessarily disturbed, moved, or destroyed by the Contractor shall be replaced by the City, in accordance with the requirements of the appropriate agency and Public Act. All costs associated with this replacement shall be charged to the Contractor.

The Contractor shall be aware that there are Section Corners and other City of Ann Arbor Geodetic control points within or near the project boundaries. The re-setting of these points, if disturbed, will require significant cost and work to restore them to their current level of accuracy. Consequently, if they are disturbed or damaged, in the sole opinion of the Engineer, the City of Ann Arbor will re-set them to a condition equal to, or better than, that which currently exists. The Contractor will be backcharged for all costs incurred in re-establishing these points including, but not limited to, time charged to coordinate the work amongst all involved parties, expenses associated with "blue-booking" the points, and all other related costs.

DETAILED SPECIFICATION  
FOR  
**MAXIMUM UNIT WEIGHT**

AA:MGN

1 of 1

02/06/14

Maximum unit weight, when used as a measure of compaction or density of soils, shall be understood to mean the maximum dry density per cubic foot (lbs/ft<sup>3</sup>) as determined by the AASHTO T-180 test.

DETAILED SPECIFICATION  
FOR  
**CONCRETE PLACEMENT AND PROTECTION**

AA:MGN  
WT:AJK:CGT

1 of 3

09/23/15  
11/20/22

**a. Description.-** This work shall consist of furnishing all labor, material, and equipment needed to furnish, place, and protect all concrete material in accordance with the requirements of this Special Provision. These requirements shall not apply to concrete bridge decks, unless otherwise noted.

**b. Materials.-** The Concrete shall meet the requirements of Sections 1001 and 1004 of the 2020 Michigan Department of Transportation Standard Specifications for Construction.

The Contractor shall propose specific concrete mix designs for the intended project purpose in accordance with the requirements of this Special Provision and other applicable Special Provisions and/or project requirements. The Engineer's acceptance of a mix design shall not relieve the Contractor of their responsibility for the manufacture of the concrete mixture(s), its placement, or performance.

**c. Construction Methods.-** The Contractor shall perform all concrete placement operations in weather that is suitable for the successful placement and curing of the concrete materials. Concrete shall not be placed during periods of active precipitation.

The Contractor shall complete all needed formwork, base and/or sub-base preparation, and any other related items that are deemed necessary for the proper completion of the work. The Contractor shall not commence the placement of concrete until they receive all needed approvals from the Engineer for placement. The Engineer's approval of the Contractor to place concrete shall not relieve the Contractor of their responsibility for the proper placement and protection of the concrete materials or its long-term performance.

During periods when precipitation is threatening, provide durable, plastic sheeting, approved by the Engineer, in sufficient quantity to cover and protect all freshly placed concrete such that precipitation does not come into contact with the concrete. The Contractor shall arrange the placement of the plastic sheeting such that the surface of any freshly placed concrete is not marred by contact with the plastic; any seams in the plastic sheeting shall be water tight. The Contractor shall place adequate supports along and over the freshly placed concrete to prevent contact of the plastic and concrete. The Contractor shall ensure that sufficient dams or barriers are placed along the edges of the freshly placed concrete to prevent erosion of the underlying materials or damage to the edges of the freshly placed concrete. All measures shall be effective.

Any concrete damaged by precipitation shall be removed and replaced at the Contractor's expense. The Engineer shall decide if the concrete has been damaged and the limits of removal and replacement.

DETAILED SPECIFICATION  
FOR  
**CONCRETE PLACEMENT AND PROTECTION**

AA:MGN  
WT:AJK:CGT

2 of 3

09/23/15  
11/20/22

Concrete shall only be placed when the rate of surface evaporation at the site is less than 0.20 pounds per square foot per hour, according to Figure 706-1 of the 2020 Michigan Department of Transportation Standard Specifications for Construction. The Contractor shall provide approved equipment for determining the relative humidity and wind velocity at the site.

Water shall not be added to the placed concrete in order to aid finishing. Any water added to the concrete for slump adjustments shall be done by adding water to the mixing unit and thoroughly re-mixing the concrete for 30 revolutions of the mixing unit at mixing speed. Water shall not be added such that the design water-to-cement ratio of the concrete mixture or the design slump of the concrete mix is exceeded.

Concrete curing shall be performed in accordance with Section 602.03.M of the 2020 MDOT Standard Specifications for Construction. Curing operations shall take precedence over texturing operations and continued concrete placement. All curing compound applied shall provide uniform coverage over the entire surface being protected. The placement of curing compound shall be free of spots, blotches, or uncovered or non-uniformly covered areas. Should any areas be determined to exist by the Engineer, the curing compound shall be immediately re-applied by the Contractor at no additional cost to the project.

**d. Weather Limitations.-** The Contractor shall take all precautions when placing concrete to protect it from damage due to the elements. Concrete shall not be placed during precipitation events.

Concrete shall be protected from weather and temperature according to the requirements of Section 602.03.T. Concrete shall not be placed when the temperature of the plastic concrete mixture itself is greater than 90° F. In conditions where low temperature protection is required, the Contractor shall cover the concrete with insulated blankets, or other means as approved by the Engineer, to protect the concrete from damage. The concrete shall remain protected until it has reached a compressive strength of at least 1000 psi, or as directed by the Engineer.

**e. Protection of Concrete from Construction Traffic, Vandalism and Graffiti.-** The Contractor shall take all needed precautions to protect any concrete placed from being damaged by foot traffic, vehicular traffic, Contractor's equipment and personnel, subsequent construction operations, vandalism, and the like.

The Contractor shall provide sufficient personnel to guard and protect newly placed concrete until such time as it has hardened sufficiently to prevent damage. Any

DETAILED SPECIFICATION  
FOR  
**CONCRETE PLACEMENT AND PROTECTION**

AA:MGN  
WT:AJK:CGT

3 of 3

09/23/15  
11/20/22

concrete curing compound damaged by Contractor foot traffic or equipment shall be immediately recoated by the Contractor at the Engineer's request.

Any concrete which is marked by graffiti, cracks other than at joints, or otherwise damaged before it has sufficiently hardened to prevent damage shall be removed and replaced in accordance with the appropriate project specifications at the Contractor's sole expense.

**f. Measurement and Payment.-** All costs associated with the conformance to the requirements of this Special Provision will not be paid for separately, but shall be considered to be included in the respective items of work.

CITY OF ANN ARBOR

NOTICE TO BIDDERS

**MAILBOX TEMPORARY RELOCATE**

WT:AJK

1 of 1

11/15/2022

**a. Description**

This work shall be completed in accordance with the requirements of section 110 of the Michigan Department of Transportation 2020 Standard Specifications for Construction.

This work shall consist of coordinating with the United States Post Office and UPS to temporarily relocate in advance of construction and reinstall after construction parcel boxes located at S. Main Street and E. Washington Street.

**b. Materials**

The Contractor shall furnish materials which may include aggregate base, concrete, and hardware which meet the requirements specified in the corresponding sections of the MDOT 2020 Standard Specifications for Construction and the requirements specified by the United States Post Office and UPS.

**c. Construction**

The Contractor shall contact United States Post Office Postmaster, Carmelo Orlando at 734 662-0223 and UPS Drop Box Support at [gbsdropboxsupport@ups.com](mailto:gbsdropboxsupport@ups.com) or contact the UPS distribution center at 734 483-1150 to provide notice and request the temporary relocation and permanent reinstall of the parcel boxes. It shall be the Contractor's sole responsibility to contact and coordinate with the corresponding parcel service in a timely and expeditious manner. The Contractor shall not be due compensation for delays caused by the USPS or UPS or their representatives.

Should the USPS and/or UPS permit the contractor to relocate and/or reinstall these boxes, the Contractor shall do so in accordance with specifications provided by the corresponding parcel service.

**d. Measurement and Basis of Payment**

The work completed and measured for Mailbox, Relocate shall be included in General Conditions, Max \$400,000 and shall not be paid for separately.

Payment for all existing base removals, excavation, finished concrete, furnished aggregate base, and installed subbase materials shall be included in payment for other pay items. Work items required by the USPS or UPS to complete this work shall not be paid for separately but shall be included in payment for the pay item Mailbox, Relocate. The unit price for these items of work shall include all labor, material, and equipment costs to perform all the work.



DETAILED SPECIFICATION  
FOR  
**FLOWABLE FILL**

AA:MGN  
AJK:

1 of 2

02/13/14  
Rev. 08/16/2022

**a. Description.-** The work shall include placing flowable fill to abandon storm sewer, sanitary sewers, or other encountered utilities, as well as sections of utility trenches where compaction of the specified backfill may not be achievable due to the proximity of surrounding utilities, ground conditions, or the like, and as directed by the Engineer. The work shall be performed in accordance with Section 203 of the 2020 Michigan Department of Transportation Standard Specifications for Construction, and as described herein.

**b. Materials.-** Flowable fill shall consist of one of the following mixes:

- a. Portland cement, fly ash, and water.
- b. Portland cement, granular material, fly ash, and water.
- c. Fly ash, granular material and water.

All flowable fill after setting is intended to be removable by conventional mechanical excavation methods.

All materials to be used in flowable fill shall meet the following requirements:

		<u>Specific Gravities ***</u>
Portland Cement	MDOT Std. Spec's. 8.01	3.15
Fly ash	ASTM C 618(1)*	2.40
Granular material Class II	MDOT Std. Spec's. 8.02**	2.60
Water	MDOT Std. Spec's. 8.11	1.00

\*Except there is no limit on the loss on ignition.

\*\*Except that 100% shall pass 3/4-inch sieve.

\*\*\*Specific gravity values used for mix proportions given. If material used differs from these values appropriate adjustments should be made.

Acceptable mixtures for flowable fill are as follows:

- I. FF Mix Number One  
Cement Stabilized Fly Ash Mixture (Class F Fly Ash)
  - Portland Cement 100 lbs./yd<sup>3</sup>
  - Fly Ash (Class F) 2000 lbs./yd<sup>3</sup>
  - Water Sufficient water to produce the desired

DETAILED SPECIFICATION  
FOR  
**FLOWABLE FILL**

AA:MGN  
AJK:

2 of 2

02/13/14  
Rev. 08/16/2022

flowability (approx. 80 gallons/yd<sup>3</sup>)

2. FF Mix Number Two  
Controlled Density Fill Mixture (Class F Fly Ash)

Portland Cement	50 lbs./yd <sup>3</sup>
Fly Ash (Class F)	500 lbs./yd <sup>3</sup>
Granular Material	2600 lbs./yd <sup>3</sup>
Water	Sufficient water to produce the desired flowability (approx. 50 gallons/yd <sup>3</sup> )
  
3. FF Mix Number Three  
Controlled Density Fill Mixture (Class C Fly Ash)

Fly Ash (Class C)	300 lbs./yd <sup>3</sup>
Granular Material	2600 lbs./yd <sup>3</sup>
Water	Sufficient water to produce the desired flowability (approx. 50 gallons/yd <sup>3</sup> )

**c. Construction Methods.-** Flowable fill shall be placed as directed by the Engineer and as specified in the associated item of work's Detailed Specification. The Contractor is responsible to provide all needed materials and appurtenances to properly introduce the flowable fill into the pipe being abandoned. The Contractor shall also provide the needed vent device(s) in order to remove air that becomes trapped during the grouting operations. All measures provided by the Contractor for the introduction and venting of the grouting operations shall be effective.

**d. Method of Payment.-** The cost of Flowable Fill shall be included in the contract unit prices for the items of work for which it is associated and will not be paid for separately.

DETAILED SPECIFICATION  
FOR  
**PROGRESS CLAUSE**

WT:CGT:VCM:CEW	1 of 6	11/21/22
----------------	--------	----------

**a. Description.-**

**Examination of Plans, Specifications, and Work Site:** Bidders shall carefully examine the Bid Form, plans, specifications, and the work site until the Bidder is satisfied as to all local conditions affecting the Contract and the detailed requirements of construction. The submission of the bid shall be considered prima facie evidence that the Bidder has made such examination and is satisfied as to the conditions to be encountered in performing the work and all requirements of the Contract.

This Contract requires water main, storm sewer, sanitary sewer, concrete curb and gutters, concrete sidewalks, bituminous paving, signal work, and associated work on S Main Street from William to Huron Street.

The entire work under this Contract shall be completed in accordance with, and subject to, the scheduling requirements as outlined below, in the Maintenance of Traffic and Sequence of Construction Detailed Specification, and all other requirements of the Contract Documents.

1. The Contractor is expected to be furnished with an electronic copy of the Contract, for his/her execution, on or before **January 3, 2023**. The Contractor shall electronically execute the Contract and return it, with the required Bonds and Insurance Certificate, to the City within **fourteen (14) days**. City Council review and approval of the Contract is expected on **February 6, 2023** (or first meeting date in February as determined by Council). The Notice of Award would be provided after the Council approval. The Contractor shall not begin the work on-site before the applicable date(s) as described herein without approval from the Project Engineer, and in no case before the receipt of the fully executed Contract.
2. The Contractor shall only begin the work of this project upon receipt of the fully executed Contract and Notice to Proceed, which anticipated to be on or before **February 20, 2023**. Appropriate time extensions shall be granted if the Notice to Proceed is delayed beyond this date. Given the need to start the project on-time and meet deadlines, time extensions for Phase 1 will not be granted for delays associated with material procurement. Please note the contract has incentives for timely completion of each Phase. The Contractor may elect to procure materials at their own risk prior to the Notice to Proceed being issued in order to meet the schedule if material delays are anticipated. Work on this project may not begin without an Engineer approved project schedule submitted by the Contractor that includes details of guaranteed material delivery dates. In the event that material delays result in a project start date or Phase completion dates that do not allow for the completion of work within the timeframe listed herein, the Engineer may elect

DETAILED SPECIFICATION  
FOR  
**PROGRESS CLAUSE**

WT:CGT:VCM:CEW

2 of 6

11/21/22

to delay the project or selected phases of the project to 2024. All bid prices shall be held per the approved contract regardless of delays and/or schedule changes.

3. **Phase 1 Work** – All Phase 1 work in S Main St from William to Liberty and within the William/Main and Liberty/Main intersections shall be completed as shown on the overall phasing plan. This includes the installation of watermain, storm sewer, paving, restoration, signal work, pavement markings, signage and all other work included in the Contract for this block. During this phase, the watermain shall be completed, tested and connected to the existing watermain at William, east and west on Liberty, and at the temporary connection just north of Liberty. Note that the Engineer may request watermain shutdowns to occur during non-standard hours to ensure minimal interruption to businesses along S Main St. All Phase 1 services shall be installed and connected during this phase. Existing watermain within Phase 1 limits shall be abandoned once the proposed Phase 1 watermain is tested, accepted, and put in service.

Phase 1 shall be completed in its entirety and open to traffic by **May 5, 2023**. All Phase 1 work shall be completed prior to the beginning of Phase 2 work.

4. **Phase 2 Work** – All Phase 2 work in S Main St from north of Liberty to south of Huron and within the Washington/Main intersection shall be completed as shown on the overall phasing plan. This includes the installation of watermain, storm sewer, paving, restoration, signal work, pavement markings, signage and all items of work included in the Contract for these two blocks (except for sidewalk, curb and pavement work on the southeast and southwest quadrants of Huron/Main intersection). During this phase, the watermain shall be completed, tested and connected to the existing watermain east and west on Washington and just south of Huron (connection just south of Huron shall be completed in such a way to limit disturbance to the surface at the Huron/Main intersection). The temporary Phase 1 watermain connection shall be removed and the Phase 2 watermain shall be connected to the Phase 1 watermain. Note that the Engineer may request watermain shutdowns to occur during non-standard hours to ensure minimal interruption to businesses along S Main St. All Phase 2 services shall be installed and connected during this phase. Existing watermain within Phase 2 limits shall be abandoned once the proposed Phase 2 watermain is tested, accepted and put in service.

Phase 2 shall be completed in its entirety and open to traffic by **July 12, 2023**. All Phase 2 work shall be completed prior to the beginning of Phase 3 work.

5. **Ann Arbor Art Fair (July 17 2023 – July 22, 2023)** - No work is allowed within the Art Fair limits and shuttle routes between the Monday prior to Art Fair and the Monday following it (July 17, 2023 – July 24, 2023). This project falls within the

DETAILED SPECIFICATION  
FOR  
**PROGRESS CLAUSE**

WT:CGT:VCM:CEW

3 of 6

11/21/22

limits of the Ann Arbor Art Fair. Phases 1 and 2 shall be completed, and the site shall be left in a clean, safe and orderly condition and all equipment and stored material shall be relocated off-site. In the event that the milestones above are delayed and the Phase 2 work has not been completed by July 12, 2023, the Contractor will be responsible for cleaning, securing and providing temporary use of the area for the Art Fair from July 17, 2023 – July 24, 2023. Prior to work stoppage all businesses shall have pedestrian access in place, all equipment and stored materials will be relocated off site, all street surfaces shall have a temporary HMA surface, and all unnecessary barricades removed. The site will be left in a clean, safe and orderly condition. If the milestones, adjusted for approved extensions of time, are delayed, temporary pavement and provisions needed to ensure the site meets conditions listed above will be at the sole cost of the Contractor.

6. **Phase 3 Work** – All Phase 3 work in S Main St at the Huron/Main intersection shall not begin until after the Ann Arbor Art Fair unless otherwise approved by the Engineer. All Phase 3 work shall be completed as shown in the overall phasing plan. This includes the installation of storm sewer, paving, restoration, pavement markings, signage and all other work included in the Contract for this intersection.

Phase 3 shall be completed in its entirety and open to traffic by **August 25, 2023**.

7. All Contract work must be complete and open to traffic by **August 25, 2023**. Project completion includes, but not limited to: install, swab, chlorinate, pressure test, flush and test the new water main pipe, connect all water service leads to the new main and complete all the remaining work under this Contract for South Main Street including, but not limited to the installation of storm sewer, signal work, miscellaneous utilities, restoration of all disturbed areas, permanent placement of hot mix asphalt and/or concrete, and the removal of any and all traffic control devices.
8. It is anticipated that the Contractor will perform all removals, remove materials off-site, and begin watermain installation prior to Seasonal Weight Restrictions (Michigan Frost Laws). It is also anticipated that the Contractor will make the necessary provisions in coordination with the Engineer to stockpile necessary materials and equipment on-site, and continue on-site work during the Seasonal Weight Restrictions (Michigan Frost Laws). An extension of time shall be granted for the number of days Seasonal Weight Restrictions are in effect beyond 21 days. No extension shall be allowed if Seasonal Weight Restrictions are in effect for 21 or fewer days.

Time is of the essence in the performance of the work of this Contract. The Contractor is expected to mobilize sufficient personnel and equipment and work throughout all authorized

DETAILED SPECIFICATION  
FOR  
**PROGRESS CLAUSE**

WT:CGT:VCM:CEW	4 of 6	11/21/22
----------------	--------	----------

hours to complete the project by the final completion date. Should the Contractor demonstrate that they must work on some Sundays in order to maintain the project schedule, they may do so between the hours of 9:00 a.m. and 5:00 p.m. with prior approval from the City. There will be no additional compensation due to the Contractor for work performed on Sundays.

Prior to the start of any construction, the Contractor shall submit a detailed schedule of work for the Engineer's review and approval. Work shall not be started until a schedule is approved in writing by the Engineer. The proposed schedule must fully comply with the scheduling requirements contained in this Detailed Specification. The Contractor shall update the approved work schedule upon request by the Engineer and present it to the Engineer within seven days of said request.

The Engineer may delay or stop the work due to threatening and/or inclement weather conditions. The Contractor shall not be compensated for unused materials or downtime due to weather conditions. The Contractor is solely responsible for protecting utilities, repairing all damages to the work and to the site, including road infrastructures, road subgrades, utilities, and any adjacent properties, which are caused as a result of working in the inclement weather conditions.

The Contractor shall not work in the dark except as approved by the Engineer and only when lighting for night work is provided as detailed elsewhere in this Contract. The Engineer may stop the work, or may require the Contractor to defer certain work to another day, if, in the Engineer's opinion, the work cannot be completed within the remaining daylight hours, or if inadequate daylight is present to either properly perform or inspect the work. The Contractor will not be compensated for unused materials or downtime, when delays or work stoppages are directed by the Engineer for darkness and/or inadequate remaining daylight reasons. The Contractor is solely responsible for protecting utilities, repairing all damages to the work and to the site, including road infrastructures, road subgrades, utilities, and any adjacent properties, which are caused as a result of working in the dark.

Failure to complete all work as specified herein within the times specified herein, including time extensions granted thereto as determined by the Engineer, shall entitle the City to deduct from the payments due the Contractor, **\$5,00.00** in Liquidated Damages, and not as a penalty, for delays in the completion of the work for each and every calendar day beyond the "Calendar Days to Complete" for each sub-phase, as required by this Detailed Specification.

Liquidated Damages will be assessed until the required work is completed in the current construction season. If, with the Engineer's approval, work is extended beyond seasonal limitations, the assessment of Liquidated Damages will be discontinued until the work is resumed in the following construction season. Liquidated Damages will be assessed until

DETAILED SPECIFICATION  
FOR  
**PROGRESS CLAUSE**

WT:CGT:VCM:CEW	5 of 6	11/21/22
----------------	--------	----------

all required work is completed for each phase as defined herein. There are no maximum limit on the Liquidated Damages amounts that may be charged to the Contractor.

As a financial incentive to complete the Project in a timely manner, and as additional consideration for the Liquidated Damages provision, the City of Ann Arbor agrees to pay the Contractor a lump sum for the work completion, as defined herein, in advance of the date established for each Phase of construction specified.

Liquidated Damages will be assessed or "Allowance for Incentives for Timely Completion of Work Phase \_\_\_" will be awarded for the following interim completion phases based on the following dates:

1. Phase 1: May 5, 2023
2. Phase 2: July 12, 2023
3. Phase 3: August 25, 2023

The "Allowance for Incentives for Timely Completion of Work Phase \_\_\_" will be as follows for each phase of work:

1. Phase 1: \$50,000 (L.S.) for completion on or before May 5, 2023
2. Phase 2: \$100,000 (L.S.) for completion on or before July 12, 2023
3. Phase 3: \$50,000 (L.S.) for completion on or before August 25, 2023

For a total Contract maximum amount of \$200,000.00. This amount is considered as an allowance in the bid. The stated dates for timely completion shall not be extended for any reason.

Should the Engineer approve a request for extension of time and revise any Contract completion dates, the Liquidated Damages will be based on the revised dates for which the time extensions specifically apply. Engineered approved extensions of time do not apply to completion dates to earn "Allowance for Incentives for Timely Completion of Work Phase \_\_\_". "Allowance for Incentives for Timely Completion of Work Phase \_\_\_" will only be awarded to the Contractor for completion of the specified phase by the exact specified date above, regardless of approved extensions of time.

**b. Measurement and Payment.**- Any "Allowance for Incentives for Timely Completion of Work Phase \_\_\_" earned as described above will be paid using the following pay items:

<b><u>Contract Item (Pay Item)</u></b>	<b><u>Pay Unit</u></b>
Allowance for Incentives for Timely Completion of Work Phase ___ Dollar	Lump Sum

DETAILED SPECIFICATION  
FOR  
**PROGRESS CLAUSE**

WT:CGT:VCM:CEW	6 of 6	11/21/22
----------------	--------	----------

“Allowance for Incentives for Timely Completion of Work Phase \_\_\_” shall be measured and paid for in accordance with the requirements of this special provision and payment shall include any and all labor, material and equipment costs to perform all of the work specified on the Contract drawings, Contract documents, and as directed by the Engineer.

All incentive amounts are additive and may be paid concurrently up to the maximum stated amounts for each Phase.



DETAILED SPECIFICATION  
FOR  
**GENERAL CONDITIONS, MAX. \$400,000**

WT:VCM:CGT

1 of 3

11/19/22

a. **Description.-** This work shall consist of performing all needed preparatory work and operations needed to begin the work of the project. All elements of this item of work are to be performed in accordance with the City of Ann Arbor Standard Specifications for Construction (current edition), as shown on the plans, and as directed by the Engineer.

b. **Materials.-** None specified.

c. **Methods of Construction.-** This item shall include all work described and required by the Plans and Specifications for which no item of work is listed in the Bid Form, including but not limited to:

- Scheduling and organization of all work, subcontractors, suppliers, material testing, inspection, and construction surveying and staking;
- Coordination of, and cooperation with, other contractors, agencies, departments, and utilities;
- Coordination with City forces to stockpile and load used castings on City vehicles;
- Protection and maintenance of all existing utilities, including support, protection, capping, repair, replacement, connection or re-connection of existing pipes, and utilities damaged by the Contractor's operations;
- Maintaining and removing all soil erosion and sedimentation controls (as specified herein or as shown on project plans) for which no pay item exists;
- Maintaining the site, and all areas within the Construction Influence Area, in a well-graded and drained state at all times during the course of the project. De-watering and drainage of all excavations as required to maintain a stable, open hole;
- The continuous maintenance of the temporary road surface within the Construction Influence Area throughout the duration of the construction. This includes any needed grading to maintain the surface in a smooth condition free of potholes, ruts, bumps, or other objectionable conditions.
- Temporary sheeting, bracing, and shoring of excavations in accordance with the applicable MIOSHA Standards;
- Maintaining driveway openings, sidewalks, bike paths, mail deliveries, and solid waste/recycle pick-ups. This includes the placement and maintenance of

CITY OF ANN ARBOR  
DETAILED SPECIFICATION  
FOR  
**GENERAL CONDITIONS, MAX. \$400,000**

WT:VCM:CGT

2 of 3

11/19/22

maintenance aggregate in driveway openings and on sidewalks and ramps as needed and as directed by the Engineer;

- Using quantities of dust palliative, maintenance aggregate, and hot patching mixture for use as temporary base, surfacing, and dust control at utility crossings, side roads and driveways;
- Storing all materials and equipment off lawn areas;
- Temporary removal/re-location, storage, and re-installation/re-setting of existing street name, guide, and regulatory signs, mailboxes, newspaper tubes, etc. which conflict with the proposed construction;
- Site clean-up on a daily basis during the course of the project's construction;
- Coordination efforts to furnish the various required HMA mixtures as directed by the Engineer;
- Coordination efforts to furnish and operate various-size vehicles/equipment as directed by the Engineer;
- Furnishing and operating vacuum-type street cleaning equipment a minimum of once per week, or more frequently, if directed by the Engineer;
- Furnishing and operating vacuum-type utility structure cleaning equipment,
- Furnishing and operating both vibratory plate and pneumatic-type ("pogo-stick") compactors;
- Furnishing and operating a backhoe during all work activities;
- Furnishing and operating a jackhammer and air compressor during all work activities;
- Noise and dust control in accordance with the applicable City of Ann Arbor Ordinances;
- Mobilization(s) and demobilization(s) of all needed materials, equipment, and personnel;
- Furnishing of all required shop drawings, informational submittals, and material certifications for all needed materials and supplies incorporated into the project;

CITY OF ANN ARBOR  
 DETAILED SPECIFICATION  
 FOR  
**GENERAL CONDITIONS, MAX. \$400,000**

WT:VCM:CGT	3 of 3	11/19/22
------------	--------	----------

- The proper off-site disposal of all excavated materials and debris. The Contractor shall dispose of, at the Contractor's expense, all excavated material. Costs for this work will not be paid for separately.
- Removal of shrubs, brush, and trees less than 6" diameter (DBH) as shown on the plan sheets or as directed by Engineer;
- Trimming of trees and brush to accommodate intersection sight distance as shown on plans;
- Fencing to protect excavation over 1' in depth during non-work hours. The fencing must be a minimum of 36" high, be constructed of orange HDPE material, and reasonably secured to prevent unwanted access;
- All miscellaneous and incidental items such as overhead, insurance, and permits; and,
- Meeting all requirements relating to Debarment Certification, Davis Bacon Act, and Disadvantaged Business Enterprise, and providing the necessary documentation.

d. **Measurement and Payment.**- This item of work will be paid for on a pro-rata basis at the time of each progress payment. Measurement will be based on the ratio between work completed during the payment period and the total contract amount. When all of the work of this Contract has been completed, the measurement of this item shall be 1.0 Lump Sum, minus any deductions incurred for inadequate performance. This amount will not be increased for any reason, including extensions of time, extras, and/or additional work.

The completed work as measured for this item of work will be paid for at the contract unit price for the following contract item (pay item):

<b><u>Contract Item (Pay Item)</u></b>	<b><u>Pay Unit</u></b>
General Conditions, Max. \$400,000.....	Lump Sum

The unit price for this item of work shall include all labor, material, and equipment costs to perform all the work specified in the City of Ann Arbor Standard Specifications for Construction and as modified by this Detailed Specification.

DETAILED SPECIFICATION  
FOR  
**CERTIFIED PAYROLL COMPLIANCE AND REPORTING**

WT:VCM

1 of 2

11/19/22

**a. Description.-** This specification covers all administrative requirements, payroll reporting procedures to be followed by Contractors performing work on City-sponsored public improvements projects, and all other miscellaneous and incidental costs associated with complying with the applicable sections of the City of Ann Arbor Code of Ordinances with regard to payment of prevailing wages and its Prevailing Wage Compliance policy.

This specification is **not** intended to include the actual labor costs associated with the payment of prevailing wages as required. Those costs should be properly incorporated in all other items of work bid.

**b. General.-** The Contractor is expected to comply with all applicable sections of Federal and State prevailing wage laws, duly promulgated regulations, the City of Ann Arbor Code of Ordinances, and its Prevailing Wage Compliance Policy as defined within the contract documents. The Contractor shall provide the required certified payrolls, city-required declarations, and reports requested elsewhere in the contract documents within the timeline(s) stipulated therein.

The Contractor shall also provide corrected copies of any submitted documents that are found to contain errors, omissions, inconsistencies, or other defects that render the report invalid. The corrected copies shall be provided when requested by the Supervising Professional.

The Contractor shall also attend any required meetings as needed to fully discuss and ensure compliance with the contract requirements regarding prevailing wage compliance. The Contractor shall require all employees engaged in on-site work to participate in, provide the requested information to the extent practicable, and cooperate in the interview process. The City of Ann Arbor will provide the needed language interpreters in order to perform wage rate interviews or other field investigations as needed.

Certified Payrolls may be submitted on City-provided forms or forms used by the Contractor, as long as the Contractor's forms contain all required payroll information. If the Contractor elects to provide their own forms, the forms shall be approved by the Supervising Professional prior to the beginning of on-site work.

**c. Unbalanced Bidding.-** The City of Ann Arbor will examine the submitted cost for this item of work prior to contract award. If the City determines, in its sole discretion, that the costs bid by the Contractor for complying with the contract requirements are not reasonable, accurately reported, or may contain discrepancies, the City reserves the right

to request additional documentation that fully supports and justifies the price as bid. Should the submitted information not be determined to be reasonable or justify the costs, the City reserves the right to pursue award of the contract to the second low bidder without penalty or prejudice to any other remedies that it may have or may elect to exercise with respect to the original low-bidder.

The Contract Completion date will not be extended as a result of the City’s investigation of the as-bid amount for this item of work, even if the anticipated contract award date must be adjusted. The only exception will be if the Contractor adequately demonstrates that their costs were appropriate and justifiable. If so, the City will adjust the contract completion date by the number of calendar days commensurate with the length of the investigation, if the published Notice to Proceed date of the work cannot be met. The contract unit prices for all other items of work will not be adjusted regardless of an adjustment of the contract completion date being made.

**d. Measurement and Payment.-** The completed work as measured for this item of work will be paid for at the Contract Unit Price for the following Contract (Pay) Item:

<u>Contract Item (Pay Item)</u>	<u>Pay Unit</u>
Certified Payroll Compliance and Reporting .....	Lump Sum

The unit price for this item of work shall include all supervisory, accounting, administrative, and equipment costs needed to monitor and perform all work related to maintaining compliance with the tasks specified in this Detailed Specification, the City of Ann Arbor Code of Ordinances, its Prevailing Wage Compliance policy and the applicable Federal and State laws.

Payment for this work will be made with each progress payment, on a pro-rata basis, based on the percentage of construction completed. When all of the work of this contract has been completed, the measurement of this item shall be 1.0 times the Lump Sum bid amount. This amount will not be increased for any reason, including extensions of time, extra work, and/or adjustments to existing items of work.

DETAILED SPECIFICATION  
FOR  
MINOR TRAFFIC DEVICES, MAX. \$160,000

WT:VCM:CGT

1 of 2

11/19/22

---

**a. Description.-** This work shall consist of protecting and maintaining vehicular and pedestrian traffic in accordance with the City of Ann Arbor Standard Specifications for Construction; Section 812 of the 2020 MDOT Standard Specifications for Construction; Part 6 of the Michigan Manual of Uniform Traffic Control Devices, Latest Revised Edition (MMUTCD); this Detailed Specification; and, as shown on the plans and as directed by the Engineer.

This item of work shall include, but not be limited to:

- The furnishing and operating of miscellaneous signs, warning devices, flag-persons, temporary concrete barriers, and drums, channelizing devices, cones as required for the entire duration of the project;
- The operation of additional signs furnished by the City;
- Furnishing and installing meter bags (where required);
- Coordinating with the City to have meter heads removed and reinstalled (where required);
- Coordinating with the City on signal timing and phasing changes;
- Maintaining pedestrian traffic;
- Temporarily covering conflicting traffic controls with Engineer-approved covers;
- Temporarily covering conflicting existing signs as directed by the Engineer with approved sign covers; and,
- Any and all other miscellaneous and/or incidental items that are necessary to properly and safely perform the work.

The Contractor shall maintain vehicular and pedestrian traffic during the work by the use of flag-persons, channelizing devices, and signs as necessary, as directed by the Engineer, and in accordance with MMUTCD.

Typical applications for maintaining pedestrian traffic in accordance with the MMUTCD are included in plan set for this project.

**b. Materials.-** Traffic maintenance material and equipment shall meet the requirements as specified in Section 812.02 of the 2020 MDOT Standard Specifications for Construction.

**c. Construction Methods.-** All temporary traffic/pedestrian control devices furnished by the Contractor shall remain the property of the Contractor. The City shall not be responsible for stolen or damaged signs, barricades, barricade lights or other traffic maintenance items. The Contractor shall replace missing traffic control devices immediately and at no additional cost to the City.

All existing signs, and signs erected by the City of Ann Arbor, on this project shall be preserved, protected, and maintained by the Contractor. Existing City-owned signs that are damaged by the Contractor during the work will be repaired by the City at the Contractor's expense.

The Contractor shall temporarily cover conflicting traffic and/or parking signs when directed by the Engineer.

When traffic control devices have been damaged by, or due to, the negligence of the Contractor, his subcontractors or material suppliers, the traffic control devices shall be replaced at the Contractor's sole expense.

The Contractor shall furnish and install the traffic control items as shown on the contract plan sheets and details included therein.

"Road Work Ahead" warning signs shall be placed, as indicated on the Plans, or as directed by the Engineer, prior to the start of work, regardless of the nature, magnitude or duration of the work.

Removable black pavement marking cover tape shall be used to cover conflicting pavement markings as directed by the Engineer.

Temporary pavement markings may be used within transition areas, if requested by the Contractor, and approved by the Engineer. All temporary pavement markings shall be removable.

**d. Measurement and Payment.-** This item of work will be paid for on a pro-rata basis at the time of each progress payment. Measurement will be based on the ratio between work completed during the payment period and the total contract amount. When all of the work of this Contract has been completed, the measurement of this item shall be 1.0 Lump Sum.

The completed work as measured for this item of work shall be paid for at the contract unit price for the following contract item (Pay Item):

<b><u>Contract Item (Pay Item)</u></b>	<b><u>Pay Unit</u></b>
Minor Traffic Devices, Max \$160,000	Lump Sum

The unit price for this item of work shall include all labor, material, and equipment costs required to perform the work specified herein.

DETAILED SPECIFICATION  
FOR  
**AUDIO-VISUAL RECORDING**

AA:MGN

1 of 4

02/06/14

**a. Description.-** This work shall include providing a recording of the physical, structural, and aesthetic conditions of the construction site and adjacent areas as provided herein.

The audio-visual recording shall be:

1. Of professional quality, providing a clear and accurate audio and visual record of existing conditions.
2. Prepared during the three (3) week period immediately prior to the preconstruction meeting.
3. Furnished to the Engineer a minimum of two (2) weeks prior to bringing any materials or equipment within the areas described in this Detailed Specification.
4. Furnished to the Engineer either at, or prior to, the preconstruction meeting.
5. Carried-out under the supervision of the Engineer.

The Contractor shall furnish two (2) copies of the completed recording to the Engineer at, or prior to, the preconstruction meeting. An index of the recording, which will enable any area of the project to be easily found on the recording, shall be included. The Contractor shall retain a third copy of the recording for his/her own use.

Any portion of the recording determined by the Engineer to be unacceptable for the documentation of existing conditions shall be recorded again, at the Contractor's sole expense, and submitted to the Engineer prior to mobilizing onto the site.

**b. Production.-** The audio-visual recording shall be completed in accordance with the following minimum requirements:

1. DVD Format / No Editing.- The audio-visual recording shall be performed using equipment that allows audio and visual information to be recorded simultaneously and in color. The recording shall be provided on compact discs in DVD format. The quality of the recording shall be equal to or better than the standard in the industry. The recording shall not be edited.
2. Perspective / Speed / Pan / Zoom.- To ensure proper perspective, the distance from the ground to the camera lens shall not be less than 12 feet and the recording must proceed in the general direction of travel at a speed not to exceed 48 feet per minute (0.55 miles per hour). Pan and zoom rates shall be controlled sufficiently so that playback will ensure quality of the object viewed.



DETAILED SPECIFICATION  
FOR  
**AUDIO-VISUAL RECORDING**

AA:MGN

2 of 4

02/06/14

3. Display.- The recording equipment shall have transparent time, date stamp and digital annotation capabilities. The final copies of the recording shall continuously and simultaneously display the time (hours:minutes:seconds) and the date (month/date/year) in the upper left-hand corner of the frame. Accurate project stationing shall be included in the lower half of the frame in standard station format (i.e. 1+00). Below the stationing periodic information is to be shown, including project name, name of area shown, direction of travel, viewing direction, etc.

On streets or in areas where there is no project stationing, assumed stationing shall be used, starting with 0+00 and progressing from west to east or from north to south.

4. Audio Commentary / Visual Features. Locations relative to project limits and landmarks must be identified by both audio and video means at intervals no longer than 100 feet along the recording route. Additional audio commentary shall be provided as necessary during the recording to describe streets, buildings, landmarks, and other details, which will enhance the record of existing conditions.
5. Visibility / Ground Cover.- The recording shall be performed during a time of good visibility. The recording shall not be performed during periods of precipitation or when snow, leaves, or other natural debris obstruct the area being recorded.

**c. Coverage.-** The audio-visual recording coverage shall include the following:

1. General Criteria.- This general criteria shall apply to all recording and shall include all areas where construction activities will take place or where construction vehicles or equipment will be operated or parked and/or where materials will be stored or through which they will be transported. The recording shall extend an additional 50 feet outside of all areas. The recording shall include all significant, existing man-made and natural features such as driveways, sidewalks, utility covers, utility markers, utility poles, other utility features, traffic signal structures and features, public signs, private signs, fences, landscaping, trees, shrubs, other vegetation, and other similar or significant features.
2. Private Property.- Record all private property that may be utilized by the Contractor in conjunction with this project. These project areas must be disclosed by the Contractor prior to using them for the work of this project.
3. Road Construction Area.- The recording coverage shall:
  - a. Extend to 50 feet outside of the right-of-way and easements area as shown on the plans.

DETAILED SPECIFICATION  
FOR  
**AUDIO-VISUAL RECORDING**

AA:MGN

3 of 4

02/06/14

- b. Extend 50 feet outside the construction limits on all streets, including side streets.  
Both sides of each street shall be recorded separately.
- 4. Detour Route / Maintenance of Traffic Areas. The entire detour route and maintenance of traffic areas shall be recorded as indicated in this Detailed Specification except as follows:
  - a. The recording must proceed in the general direction of travel at a speed not exceeding 176 feet per minute (2 miles per hour).
  - b. The coverage area shall include the street and not go beyond the curb except in areas where there is a fair possibility that the detoured traffic will drive over the curb, such as at intersections.
  - c. The recording shall focus in particular at sidewalk ramps and other features likely to have been damaged or likely to be damaged as a result of existing traffic, temporary detoured traffic and or construction traffic. In these areas, recording may need to proceed much more slowly.  
Only the side of street with the detoured traffic must be recorded. However, the Contractor is advised that portions of the detour routes may operate in opposite directions at different times. In these cases, both sides of the street shall be recorded separately.
- 5. Private Property bordering the project limits or work areas - along Stadium Boulevard between S 7<sup>th</sup> Street to immediately east of Kipke Drive; Prescott Avenue from Stadium Boulevard to Potter Avenue; and Potter Avenue from Prescott Avenue to Hutchins Avenue. Record all areas bordering the project where work is scheduled to occur or where construction traffic could damage the private property. This is to including buildings, driveways, decks, landscaping, trees, and all other similar features.
- 6. Other Areas.- The Contractor shall record at his sole expense other areas where, in his/her opinion, the establishment of a record of existing conditions is warranted. The Contractor shall notify the Engineer in writing of such areas.

The Engineer may direct the recording of other minor areas not specified herein at the Contractor's sole expense.

**d. Audio-Visual Recording Services.-** The following companies are known to be capable of providing the recording services required by this Detailed Specification and shall be utilized, unless the Contractor receives prior written approval from the Engineer to utilize another company of comparable or superior qualifications.

Construction Video Media  
Midwest Company

DETAILED SPECIFICATION  
FOR  
**AUDIO-VISUAL RECORDING**

AA:MGN

4 of 4

02/06/14

Topo Video, Inc.  
Video Media Corp.  
Paradigm 2000, Inc.  
Finishing Touch Photo and Video

**e. Measurement and Payment.**- The completed work shall be paid for at the contract unit price for the following contract item (pay item):

<u>Contract Item (Pay Item)</u>	<u>Pay Unit</u>
---------------------------------	-----------------

Audio-visual Recording .....	Lump Sum
------------------------------	----------

Audio-visual Recording shall include all labor, equipment, and materials required to perform the recording and to provide the finished recording the Engineer.

Payment will be made for Audio-visual Recording following the review and acceptance of the recording by the Engineer. Within 21 days following the receipt of the recording, the Engineer will either accept it and authorize payment or require that any discrepancies in the recording be addressed prior to making payment.

DETAILED SPECIFICATION  
FOR  
EXPLORATORY EXCAVATION

WT:VCM:CGT

1 of 2

11/19/22

**a. Description.** The use of this Detailed Specification is to compensate the Contractor to locate underground infrastructure, such as culverts, sewers, utilities, and/or to expose the existing pavement section. Use must only be as directed and approved by the Engineer. This Detailed Specification is not to compensate the Contractor for the responsibilities in subsection 107.12 of the 2020 MDOT Standard Specifications for Construction.

This work consists of conducting a vertical exploratory investigation to expose an existing culvert, sewer, utility/utility service, or the existing pavement section in order to verify the location, condition, size, material, alignment and/or composition; allowing the Engineer to document the necessary information; and backfilling the excavation. It includes providing necessary lane, shoulder and/or sidewalk closures required to perform the work.

The intent of “Exploratory Excavation” is not to provide a means for the Contractor to locate each existing utility throughout the project, but for those that appear to be in conflict with the proposed work and their location is unclear or unknown. The Contractor is responsible for “using reasonable care to establish the precise location of the underground facilities in advance of construction” (Public Act 174 of 2013 - Miss Dig Law) as a part of the overall project contract.

**b. Materials.** Use Granular Material Class III in accordance with section 902 of the 2020 MDOT Standard Specifications for Construction for backfill. Use material removed during exploratory investigation for backfill only if approved by of the Engineer.

**c. Construction.** The owner of any sewer or utility to be exposed will not take the facilities out of service during the exploratory investigation. Contact utility owners in accordance with subsection 107.12 of the 2020 MDOT Standard Specifications for Construction.

Establish necessary lane, shoulder and/or sidewalk closures required to perform work.

Advance the exploratory excavation using vacuum excavation, hand digging, conventional machine excavation, or a combination thereof subject to approval of the Engineer. Allow the Engineer access to document the necessary information. If the technique used to advance the excavation causes any damage to the existing facilities, immediately contact the utility owner and cease all work until Engineer approves of an alternate method.

Take care to protect the exposed culvert, sewer or utility from damage during construction. Repair or replace culvert, sewer or utility, damaged during exploratory excavation, in accordance with the standard specifications and as approved by the Engineer.

Obtain the Engineer's approval before backfilling the excavation. Complete backfilling no later than 24 hours after approval. Backfill in accordance with subsection 204.03.C of the

DETAILED SPECIFICATION  
FOR  
**EXPLORATORY EXCAVATION**

WT:VCM:CGT	2 of 2	11/19/22
------------	--------	----------

2020 MDOT Standard Specifications for Construction. Dispose of excess material in accordance with the standard specifications.

The Contractor is responsible for all costs associated with the repair work and out of service time of all broken or damaged existing culverts, sewers or utilities resulting from any action by the Contractor. If the exploratory investigation results in damage to utilities, contact the owner of such utility to coordinate the repair.

**d. Measurement and Payment.** Measure and pay for the completed work, as described, at the contract unit price for the following pay item:

<u>Pay Item</u>	<u>Pay Unit</u>
Exploratory Excavation, (0-10 ft. deep) (Trench Det 1, Modified) .....	Each

**Exploratory Excavation, (0-10 ft. deep) (Trench Det 1, Modified)** will be paid for per each excavation a maximum of 10-feet deep for a 4-foot maximum diameter hole, or as approved by the Engineer. Measure and pay for each 4-foot maximum diameter hole separately. One paid excavation may include multiple utility verifications if the utilities are close in proximity.

**Exploratory Excavation, (0-10 ft. deep) (Trench Det 1, Modified)** includes all cost for labor, equipment and materials necessary to complete the work, including all costs associated with repair or replacement resulting from the Contractor's activities.

DETAILED SPECIFICATION  
FOR  
SOIL EROSION CONTROL INLET FILTER

AA:MGN  
WT:VCM:CGT:AJK

1 of 1

02/06/14  
08/16/2022

**a. Description.-** This work consists of installing and maintaining inlet filters in accordance with Section 208 of the 2020 Michigan Department of Transportation Standard Specifications for Construction and as shown on the plans. Filters shall be installed in existing and proposed inlets in order to minimize the erosion of soil and the sedimentation of water courses. The related work includes the installation, maintenance and removal of the filter cloth, cleaning as required during the performance of the project work, removing and disposing of accumulated sediment, and replacement of filters if required by the Engineer so as to provide a properly working inlet filter and a well-drained site.

**b. Materials.-** The inlet filters shall be in accordance with the REGULAR FLOW SILTSACK® manufactured by ACF Environmental (800) 448-3636; FLEXSTORM® Style FX manufactured by Advanced Drainage Systems, Inc. (800) 821-6710; CATCH-ALL® manufactured by Price & Company (866) 960-4300, or Engineer approved equal.

The Contractor shall submit product data sheets and a sample of the filter material for inlet filters for Engineer approval prior to ordering materials.

**c. Methods of Construction.-** The Contractor shall install, maintain, clean, and re-install and/or replace inlet filters in accordance with the manufacturer's specifications and as directed by the Engineer. The Contractor shall dispose of debris off-site.

**d. Measurement and Payment.-** The completed work of Soil Erosion Control Inlet Filter will be paid for at the contract unit price for the following contract items (pay items):

<u>Contract Item (Pay Item)</u>	<u>Pay Unit</u>
Erosion Control, Inlet Filter .....	Each

"Erosion Control, Inlet Filter" will be measured by the unit installed and will be paid for at the contract unit price per each, for which price shall be payment in full for all labor, equipment, and materials needed to furnish, install, maintain, clean and remove the inlet filter, and re-install and/or replace the inlet filter as needed.

DETAIL SPECIFICATION  
FOR  
**SEWER, ANY SIZE OR DEPTH, REM  
DR STRUCTURE, ANY SIZE OR DEPTH, REM**

AA:MGN  
WT:VCM:CGT:AJK

1 of 2

02/06/14  
11/19/22

**a. Description.-** This work shall consist of furnishing all labor, tools, equipment, and material to remove, and dispose of off-site, sewers, and/or drainage structures, in accordance with Section 203 of the 2020 Michigan Department of Transportation Standard Specifications for Construction, and as specified herein.

**b. Materials.-**

Granular Material, Class II .....Section 902

**c. Construction Methods.-** Sewers, manholes, and drainage structures shall be removed, and disposed of off-site, in such a manner as not to damage any new work, or work or material which is to remain in-place. The hole or trench resulting from the removal of the manhole, sewer, or drainage structure shall be backfilled with Granular Material, Class II, in maximum lifts of 12 inches, and be compacted to 95% of its maximum unit weight, if located within the public rights-of-way, railroad rights-of-way, or within the influence paved surfaces or structures. Otherwise, backfill shall be Engineer approved native material, compacted to 90% of its maximum unit weight, in lifts of 12 inches or less, unless otherwise noted on the plans. The resulting hole left in a structure from a sewer to be removed shall be bulkheaded with bricks and mortar to provide a watertight seal and constructed such that the remaining flow in the manhole is not impeded.

As directed by the Engineer and within two days of their removal, the Contractor shall stockpile on-site, in a location that is mutually agreeable to the Engineer and Contractor, the existing structure covers. The City of Ann Arbor's forces will pick-up the structure covers at a time that is convenient to them and mutually agreeable to the Contractor. The Contractor shall provide the equipment and manpower to load the castings on the City's vehicle(s) so that they can be removed from the site by the City.

**d. Measurement and Payment.-** The completed work shall be paid for at the Contract Unit Price for the following Contract Items:

<u>Contract Item (Pay Item)</u>	<u>Pay Unit</u>
Sewer, Any Size or Depth, Rem .....	Foot
Dr Structure, Any Size or Depth, Rem .....	Each

DETAIL SPECIFICATION  
FOR  
**SEWER, ANY SIZE OR DEPTH, REM  
DR STRUCTURE, ANY SIZE OR DEPTH, REM**

AA:MGN  
WT:VCM:CGT:AJK

2 of 2

02/06/14  
11/19/22

Payment for the above items shall include all labor, material and equipment to complete the work of removing sewers and drainage structures of any size or depth as detailed herein.



DETAILED SPECIFICATION  
FOR  
**REMOVING PAVEMENT AND CONCRETE ITEMS**

AA:JKA  
WT:AJK:CGT

1 of 3

11/10/2022

**a. Description**

This work shall consist of furnishing all labor, tools, equipment, and material to remove, and dispose of off-site, any concrete curb, gutter, curb and gutter, integral curb, sidewalk, sidewalk ramps, pavement, drive openings, and drive approach pavements as shown on the plans, in accordance with section 204 2020 MDOT Standard Specifications for Construction, except as specified herein, and as directed by the Engineer.

**b. Materials**

Granular Material, Class II .....Section 902

**c. Construction**

Construction methods shall be as described in section 204 of the MDOT 2020 Standard Specifications for Construction, as described below, and as directed by the Engineer.

The pay item for "**Pav't, Rem**" will include removal and disposal of existing pavement regardless of pavement depth, type or material. Pavement materials are anticipated to include asphalt, concrete, brick, aggregate and composite pavement sections. Also included is bituminous overlay pavement on the concrete gutter without disturbing the curb and gutter remaining in place.

The pay item for "**Pav't, Rem, Special**" will include all costs to remove and dispose of bituminous and/or composite pavement overlay and to break up and remove the trolley track concrete base where necessary for utility installation, pavement cross section or any other item of work as approved by the Engineer. Concrete base foundation is anticipated to be 17-ft wide by 18-26 inches deep; however this pay item shall include the cost of removal as needed regardless of width and depth. Any steel track, wood ties or brick paving that may exist related to the track base will be considered included in this pay item and not paid for separately. Backfill of trolley track shall be paid for separately.

Prior to the start of work, the Engineer and Contractor together shall identify and field measure all items to be removed. The Engineer shall approve of all removal limits prior to any removals being performed by the Contractor.

The Contractor shall perform full-depth saw cutting at removal limits as shown on the Plans, as marked for removal, or as directed by the Engineer.

DETAILED SPECIFICATION  
FOR  
**REMOVING PAVEMENT AND CONCRETE ITEMS**

AA:JKA  
WT:AJK:CGT

2 of 3

11/10/2022

The Contractor shall cut steel reinforcement as directed by the Engineer at all areas of removal.

All saw cutting shall be performed under wet conditions to prevent excessive airborne dust. All resulting slurry and debris shall be cleaned up to the satisfaction of the Engineer.

**The Contractor shall coordinate with the City Forester prior to the removal of any tree roots.**

Excavated / removal areas shall be adequately protected with barricades and/or fencing at all times.

Removed or excavated materials which are not incorporated into the work shall become the property of the Contractor and shall be immediately removed and properly disposed of off-site. Removed or excavated materials may not be stockpiled overnight on, or adjacent to, the site.

Base, subbase, or subgrade materials removed without authorization by the Engineer shall be replaced and compacted by the Contractor at the Contractor's expense, with materials specified by the Engineer.

**d. Measurement and Payment**

The completed work, as described, will be measured and paid for at the respective contract unit prices for the following respective pay items:

<b><u>Contract Item (Pay Item)</u></b>	<b><u>Pay Unit</u></b>
Curb and Gutter, Any Type or Size, Rem .....	Foot
Sidewalk and Ramps, Rem.....	Square Foot
Pav't, Rem .....	Square Yard
Pav't, Rem, Special .....	Square Yard

Basis of payment shall be as described in subsection 205.04 of the Standard Specifications for Construction.

All saw cutting required for removals shall be included in the appropriate item of work and will not be paid for separately.

Payment will be based on the area of pavement removed, regardless of thickness, or if it is composite.

DETAILED SPECIFICATION  
FOR  
**REMOVING PAVEMENT AND CONCRETE ITEMS**

AA:JKA  
WT:AJK:CGT

3 of 3

11/10/2022

The unit price for these items of work shall include all labor, material, and equipment costs to perform all the work.

DETAILED SPECIFICATION  
FOR  
**MACHINE GRADING, MODIFIED**

AA:CEW  
WT:VCM:CGT

1 of 7

11/20/22

**a. Description.-** The pay item “Machine Grading, Modified” shall be completed in accordance with Section 205 of the Michigan Department of Transportation 2020 Standard Specifications for Construction (MDOT 2020 SSC) and shall include all work indicated in the MDOT 2020 SSC, shown on the plans, and as specified herein, with the exception that “Subgrade Undercutting, Type II,” “Subgrade Manipulation,” and “Rock Excavation” shall be paid for separately when separate pay items for the respective items are included in the proposal. “Machine Grading, Modified” shall include all the work specified herein for which there is no separate pay item.

The following abbreviated table of contents for Section 205 (Roadway Earthwork) of the MDOT 2020 SSC is provided for reference. It is not a complete table of contents for all Section 205 work required to complete the project.

<u>Section / Title</u>	<u>Page</u>
205.01 Description .....	2-18
205.02 Materials .....	2-18
205.03 Construction.....	2-19
A. Preparing Roadway Foundation .....	2-19
1. Removing and Salvaging Topsoil .....	2-19
B. Rock Excavation .....	2-20
E. Subgrade Undercutting .....	2-21
F. Subgrade Manipulation.....	2-22
G. Earth Excavation.....	2-22
H. Roadway Embankment.....	2-23
4. Placing and Compacting Embankment.....	2-24
205.04 Measurement and Payment .....	2-31

**b. Soils Information.-** Soil information provided as part of the contract documents is for informational purposes only and shall not relieve the Contractor of the responsibility of investigating all local conditions before bidding.

**c. Materials.-** All materials and mixtures shall meet the requirements as specified in Section 205 of the MDOT 2020 Standard Specifications for Construction, except as specified herein.

DETAILED SPECIFICATION  
FOR  
**MACHINE GRADING, MODIFIED**

AA:CEW  
WT:VCM:CGT

2 of 7

11/20/22

**d. General Provisions.-** The Contractor shall:

1. Maintain access to all drive entrances at all times.
2. Maintain sidewalks and access to all buildings and properties.
3. Maintain access to all mail boxes for users and the U.S. Postal Service at all times. The Engineer may direct the temporary relocation of mail boxes which would be paid for as Post, Mailbox.
4. Grade around mailboxes, trees, light poles, power poles, and the like, which are to remain in place. The Contractor shall be responsible for any damage caused to such structures.
5. Coordinate all work with utility companies and others that need to complete work within the project limits.
6. Maintain the work in a finished condition until it is accepted by the Engineer.

**e. Pavement Sawcutting.-** The work shall include the full-depth saw-cutting of pavement at the construction limits, and elsewhere as required, if not paid for as part of another item of work. Pavement sawcutting will not be paid for separately.

**f. Removal of Trees and Vegetation.-** The Contractor shall remove and properly dispose of off-site all vegetation; brush; roots; and stumps, as shown on the plans, and as directed by the Engineer as required to complete the project. This work will be paid for as Clearing (Acre).

**g. Removal and Salvaging of Topsoil.-** The removal, salvaging and stockpiling of topsoil, and all related work, shall be performed in accordance with Section 205.03.A.1 (Removing and Salvaging Topsoil) of the MDOT 2020 SSC.

**h. Miscellaneous Removals.-** The removal of bituminous, aggregate, and/or concrete materials from around manholes, structures, and utility covers, and the removal of bituminous curbing, bituminous driveway wedges, bituminous surface on existing curb and gutter, and bituminous surfaces around other miscellaneous unremoved areas shall be paid for as "Machine Grading, Modified" and will not be paid for separately.

"Machine Grading, Modified" includes the removal of any surface feature located within the grading limits which must be removed and for which there is no specific pay item established in the proposal for its removal.

**i. Protection of the Grade.-** The work shall be kept well drained at all times. Foundation, roadway embankment or subgrade that becomes damaged by rain shall be undercut and backfilled, or otherwise remedied, by the Contractor, at his/her sole expense, as directed by the Engineer.

The Contractor shall be responsible for the maintenance of the foundation, roadway embankment, and subgrade. Any damage caused by traffic or the Contractor's operations,

DETAILED SPECIFICATION  
FOR  
**MACHINE GRADING, MODIFIED**

AA:CEW  
WT:VCM:CGT

3 of 7

11/20/22

to the foundation, roadway embankment or subgrade shall be remedied by the Contractor at his/her sole expense.

The Contractor shall conduct his/her operations and provide the necessary equipment to ensure the satisfactory completion of the work without damaging the foundation, roadway embankment or subgrade. This may require the transporting and movement of materials over additional distances.

**j. Protection of Utilities and Vaults/Structures.-** Utility lines, vaults, and structures may become exposed at, above, or below, the foundation or subgrade elevation during machine grading or subgrade undercutting operations. If this occurs, the Contractor shall protect facilities and excavate around, above and/or below the utility lines, as directed, to complete the machine grading or subgrade undercutting operations. Payment, at contract unit prices, for “Machine Grading, Modified” or “Subgrade Undercutting, Type II,” whichever applies, will be considered as payment in full for this work. The contractor shall protect vaults and structures and not undermine or damage facilities.

**k. Removal of Cable, Conduits and Pipe.-** The Contractor shall remove, and properly dispose of off-site, all abandoned cables, conduit, and pipe encountered at, or above the bottom of any earthwork excavation or undercut. Where the inverts of abandoned, or to be abandoned or removed, conduits or pipe are less than 16 inches below the bottom of any earth excavation or undercut, the conduits and/or pipe shall be removed and the resulting void filled with an Engineer approved material. The fill material shall be compacted to 95% of its maximum unit weight in lifts not exceeding 12 inches. No separate payment will be made for removal of conduit or pipe, or any of the work, described in this section.

**l. Foundation Preparation.-** Foundation is defined as the original earth grade upon which roadway embankment is placed. The foundation work shall be completed in accordance with Section 205.03.A (Preparing Roadway Foundation) of the MDOT 2020 SSC as shown on the plans, and as specified herein.

The foundation shall be compacted to 95% of its maximum unit weight, as measured by the AASHTO T-180 method, to a depth of at least 10 inches. If this cannot be achieved, in the opinion of the Engineer, he/she will direct the Contractor to perform “Subgrade Undercutting, Type II” or “Subgrade Manipulation,” as described herein, on the foundation.

**m. Roadway Embankment Construction.-** Roadway embankment is defined as the construction of earth on the prepared foundation to form the subgrade. Roadway embankment work shall be completed in accordance with Section 205.03 H (Roadway Embankment) of the MDOT 2020 SSC as shown on the plans, and as specified herein.

DETAILED SPECIFICATION  
FOR  
**MACHINE GRADING, MODIFIED**

AA:CEW  
WT:VCM:CGT

4 of 7

11/20/22

Roadway embankment shall be compacted to a minimum of 95% of its maximum unit weight, as measured by the AASHTO T-180 method.

**n. Subgrade Construction.-** Subgrade is defined as the final earth grade which extends from grading limit to grading limit. The subgrade shall be constructed by performing earth excavation and roadway embankment work in accordance with Section 205.03.G (Earth Excavation) and Section 205.03 H (Roadway Embankment) of the MDOT 2020 SSC, as shown on the plans, and as specified herein.

The subgrade shall be constructed to the contours and cross-sections shown on the plans, as specified herein. To achieve this, the work shall include, but not be limited to:

1. Removal and disposal off-site of any surplus or unsuitable materials.
2. Furnishing from off-site any additional Engineer approved fill materials necessary.
3. Moving existing and/or furnished materials longitudinally and transversely as necessary.
4. Cutting, placing, compacting, and trimming existing and/or furnished materials to construct the roadway embankment and subgrade to the specified tolerances.
5. Stockpiling, and moving again, any cut materials which cannot be immediately placed upon excavation due to construction staging.

The subgrade shall be graded to accommodate all subbases and aggregate bases wherever used, all bioswale and adjacent planting beds, all roadway pavements, curb and gutter, driveways, sidewalks, bicycle paths, other similar structures, bioswale planting mix, topsoil and any other features which the subgrade supports.

The subgrade shall be prepared so as to ensure uniform support for the pavement structure. The finished subgrade shall be placed to within 1 inch below and  $\frac{3}{4}$  inch above plan grade. Variations within this tolerance shall be gradual.

The subgrade shall be compacted to a minimum of 95% of its maximum unit weight, as measured by the AASHTO T-180 method, to a depth of 10 inches. If this cannot be achieved, in the opinion of the Engineer, he/she may direct the Contractor to perform "Subgrade Undercutting, Type II" or "Subgrade Manipulation" as described herein.

**o. Test Rolling.-** The Contractor shall test-roll the foundation and/or subgrade with a pneumatic tired roller with a suitable body for ballast loading and a gross load capacity that can be varied from 25 and 40 tons. In lieu of this test roller, with the approval of the Engineer, the Contractor may use a fully loaded single axle or tandem axle dump truck.

DETAILED SPECIFICATION  
FOR  
**MACHINE GRADING, MODIFIED**

AA:CEW  
WT:VCM:CGT

5 of 7

11/20/22

**p. Subgrade Undercutting.**- “Subgrade Undercutting, Type II” shall be performed on the foundation or subgrade in accordance with Section 205.03.E (Subgrade Undercutting) of the MDOT 2020 SSC, as shown on the plans, as specified herein, and as directed by the Engineer.

**q. Subgrade Manipulation.**- “Subgrade Manipulation” shall be performed on the foundation or subgrade in accordance with Section 205.03.F (Subgrade Manipulation) of the MDOT 2020 SSC, as shown on the plans, as specified herein, and as directed by the Engineer.

Where subgrade manipulation is required, the foundation or subgrade shall be thoroughly scarified, blended, and mixed to a depth of 12 inches. The work shall be accomplished by means of a large diameter disc, motor grader, or other equipment approved by the Engineer. After the foundation or subgrade has been manipulated to the satisfaction of the Engineer and allowed to dry, the soil shall be compacted to 95% of its maximum dry density as measured by the AASHTO T-180 method. The time required for drying the soil will not be a basis for an extension of time.

The cost of Subgrade Manipulation shall be included in the cost of “Machine Grading, Modified”.

**r. Rock Excavation.**- Rock excavation shall be performed in accordance with Section 205.03.B (Rock Excavation) of the MDOT 2020 SSC, as shown on the plans, and as directed by the Engineer.

The pay item “Rock Excavation” will apply only to boulders over ½ cubic yard in volume. Boulders will be measured individually and the volume computed from the average dimension measured in three directions. The removal of rocks, concrete and masonry less than ½ cubic yard in volume shall not be included in the pay item “Rock Excavation,” but shall be included in the pay item “Machine Grading, Modified.”

If the proposal does not include a pay item for “Rock Excavation,” rocks measuring over ½ cubic yard in volume shall be paid for as extra work.

**s. Lowering Structures.**- Prior to cutting the subgrade, the Contractor shall remove structure covers, lower the structures to a point between 8 inches and 12 inches below the proposed subgrade, and cover the structures with a steel plate. Structures shall not be raised prior to placing roadway embankment.

The steel plates for covering structure openings shall conform to the plan detail, be pegged and properly placed to prevent their movement under all traffic, be thick enough to carry all traffic, and prevent the infiltration of debris into the structures.



DETAILED SPECIFICATION  
FOR  
**MACHINE GRADING, MODIFIED**

AA:CEW  
WT:VCM:CGT

6 of 7

11/20/22

The Contractor shall lower valve boxes to a point between 8 inches and 12 inches below the proposed subgrade. Valve boxes shall not be raised prior to placing roadway embankment.

The void in the grade above the steel plates used for structure lowerings and valve box lowerings shall be backfilled, and compacted to 95% of its maximum dry density, with an Engineer approved coarse aggregate.

“Machine Grading, Modified” shall include all the work associated with lowering structures, including backfilling.

The Contractor shall coordinate the lowering of private utility structures with the private utility companies.

**t. Structure Covers.-** As directed by the Engineer and within two days of their removal, the Contractor shall stockpile on-site, in a location that is mutually agreeable to the Engineer and Contractor, the existing structure covers. The City of Ann Arbor’s forces will pick-up the structure covers at a time that is convenient to them and mutually agreeable to the Contractor. The Contractor shall provide the equipment and manpower to load the castings on the City’s vehicle(s) so that they can be removed from the site by the City.

**u. Structure and Sewer Cleanliness.-** All sewers, and structures, including manholes, gate wells, valve boxes, inlet structures and curbs shall be protected from damage and contamination by debris and construction materials. Structures shall be maintained clean of construction debris and properly covered at all times during the construction. The Contractor shall immediately clean any structures and/or sewers that become contaminated with construction debris. The Contractor shall be responsible for all direct and indirect damages which are caused by sewers or structures which have been made unclean or have been damaged by the Contractor.

**v. Site Furnishings.-** The Contractor shall remove, salvage, and reinstall all site furnishings which are in conflict with proposed site work. Expected site furnishings include bicycle racks, wayfinding signage, trash cans, and decorative signage. The contractor shall furnish new hardware for the reinstallation.

**w. Contractor’s Calculations.-** Existing and proposed cross sections are provided in the plans. The Contractor shall perform his/her own computations and is responsible to inspect the site to determine his/her own estimate of the quantities of work involved.

DETAILED SPECIFICATION  
FOR  
**MACHINE GRADING, MODIFIED**

AA:CEW  
WT:VCM:CGT

7 of 7

11/20/22

Deviations between the existing contours and the existing and proposed cross-sections shown on the plans shall not be cause for additional compensation.

**x. Measurement and Payment.-** The completed work as measured will be paid for at the contract unit price for the following contract items (pay items):

<u>Contract Item (Pay Item)</u>	<u>Pay Unit</u>
Machine Grading, Modified, S Main .....	Station

“Machine Grading, Modified, S Main” will be measured once, and only once, along the centerline of the roadway or feature being constructed.

“Machine Grading, Modified, S Main” will be measured by length in 100 foot long stations, or portions thereof, along the centerline of the road.

The various pay items included herein shall include all labor, materials and equipment required to complete the work.

The Contractor shall include all of his/her costs to complete all of the Machine Grading, Modified, S Main work in the Machine Grading, Modified, S Main pay items and plan quantities included in the proposal. No additional payment will be made for Machine Grading, Modified work which, although, shown on the plans and specified herein as work which needs to be completed, may not be included in a particular Machine Grading, Modified, S Main pay item. Plan quantities will be paid for the work, and will only be adjusted due to changes in the limits of the work, as directed by the Engineer, in writing.

The pay item “Machine Grading, Modified, S Main” shall include all the work specified herein, including, but not limited to, the removal and offsite disposal of any surplus or unsuitable materials and the furnishing from off-site any additional Engineer approved fill materials necessary to construct the embankment and subgrade per plans.

The Contractor is advised that due to the phasing of the project and the probable unsuitability of some or all of the excavated material for use as approved fill material, there may be imbalances between the amount of earth cut which is suitable for reuse as fill, and the amount of earth needed to construct the lines and grades shown on the plans, or as directed by the Engineer. The Contractor shall make provisions for such imbalances and shall include in the bid price for this work the cost of importing/furnishing, placement, and compaction of the material, as well as the cost of stockpiling and re-handling of imported and/or on-site Engineer approved materials as necessary to complete the work of constructing the embankment and subgrade to the cross sections shown on the plans.

DETAILED SPECIFICATION  
FOR  
**NON-HAZARDOUS CONTAMINATED MATERIAL**

AA:MGN/NCI:AK  
WT:AJK:CGT:VCM

1 of 2

10/16/15  
11/19/2022

**a. Description.** This work shall include all labor, equipment, laboratory testing, and materials necessary to handle, transport, and dispose of non-hazardous contaminated material as described herein, as shown on the plans, and as directed by the Engineer.

**b. Method of Construction.** This work shall be performed in accordance with Sections 204 and 205 of the MDOT 2020 Standard Specifications for Construction, except as modified herein or as directed by the Engineer.

The Contractor shall have all manifests signed by its representative, the Engineer's representative, the authorized representative of the waste hauler and the waste disposal facility.

**c. Excavation of Non-Hazardous Contaminated Material.** Non-Hazardous contaminated material shall be excavated as shown on the plans and/or as directed by the Engineer.

**d. Temporary Storage of Non-Hazardous Contaminated Material.** Excavated non-hazardous contaminated material which is to be temporarily stockpiled shall be placed on plastic sheeting or tarps having a minimum thickness of 6 mils or in trucks, roll-off boxes, or other containers, such that no liquid may escape from the containment. At the end of each work day, the non-hazardous contaminated material shall be covered securely with plastic sheeting of 6 mils thickness or greater.

Excavated non-hazardous material shall be disposed of as soon as approval is received from the disposal site. In no case shall this material be stockpiled for longer than 30 days prior to disposal.

The Contractor is responsible for the necessary coordination such that his/her work activities are not adversely impacted by the stockpiling of contaminated soil. Stockpiled soil shall not impair sight distance or drainage.

**e. Sampling and Analysis of Non-Hazardous Contaminated Material.** The Contractor shall be responsible for all sampling and analysis required for the disposal of non-hazardous contaminated material. The analysis required shall be dictated by the Type II disposal facility to be utilized for disposal.

If the results of the analysis show the material to be hazardous, as defined by Part 111, of the Natural Resources and Environmental Act, Act 451, P.A. 1994, the Engineer shall be notified immediately. The material shall then be disposed of as directed by the Engineer.

DETAILED SPECIFICATION  
FOR  
**NON-HAZARDOUS CONTAMINATED MATERIAL**

AA:MGN/NCI:AK  
WT:AJK:CGT:VCM

2 of 2

10/16/15  
11/19/2022

**f. Disposal of Non-Hazardous Contaminated Material.** Disposal of non-hazardous contaminated material shall be at a licensed Type II sanitary landfill. The Contractor shall submit at the preconstruction meeting the name of the Type II landfill to be used for disposal, the sampling and analysis requirements of the landfill, and verification that the use of the proposed landfill will meet the requirements of the County solid waste plan.

The disposal must be acceptable to the Department and therefore approval must be obtained from the Engineer prior to commencing disposal operations. Prior to obtaining approval for the disposal from the Department, the Contractor shall provide a copy of the laboratory analysis to the Engineer.

**g. Measurement and Payment.** The completed work as described will be paid for at the contract unit price for the following contract item (pay item):

<u>Contract Item (Pay Item)</u>	<u>Pay Unit</u>
Non-Hazardous Contam'd Mat'l Handling and Disposal (LM) .....	Cubic Yard

Non-Hazardous Contam'd Mat'l Handling and Disposal will be measured by volume in cubic yards, loose measure, as contained in the hauling unit. Under no circumstance will the Contractor be paid for quantities of this material that have not been approved for payment by the Engineer and as measured and tracked by the Engineer and the Contractor. The Contractor will not be paid "standard amounts" that have been determined by the disposal facility; only measured volumes as computed by the Engineer will be paid. Prior to payment, the Engineer shall be given receipts from the disposal facility for the number of cubic yards disposed of at that facility. Payment shall include all costs for materials, labor and equipment needed for storage, loading, transportation, and disposal of the non-hazardous contaminated material. Disposal costs shall include all documentation required by the landfill. Payment for this item shall be the same, regardless of whether or not the Contractor temporarily stores the contaminated material; the Contractor shall not be paid for re-handling of the material due to construction staging, stockpiling, or other related activities.

Payment for excavation and handling of non-hazardous contaminated materials shall be included with the related items of work.

DETAILED SPECIFICATION  
FOR  
**SUBGRADE UNDERCUTTING**

WT:VCM:CGT

1 of 1

11/19/22

**a. Description.** This work shall include the removal of unsuitable subgrade material(s) which may be susceptible to frost heaving or differential frost action in the areas and limits identified by the Engineer, and backfilling to replace these material(s) and remedy unstable soil conditions. This work shall be done in accordance with section 205 of the Michigan Department of Transportation (MDOT) 2020 Standard Specifications for Construction, as directed by the Engineer, and as modified herein.

**b. Materials.** Provide materials in accordance with Granular Material Class II and 21AA dense-graded aggregate as specified in section 902 of the MDOT 2020 Standard Specifications for Construction.

**c. Construction.** Construction methods shall be as described in subsection 205.03.E of the MDOT 2020 Standard Specifications for Construction, and as directed by the Engineer.

After the pavement has been removed, and/or after rough/finish grading, and/or at the time of proof rolling, the Engineer may inspect the grade to determine the need for, and the limits of, undercuts. After undercut areas are excavated to the depths as directed by the Engineer, the areas shall be trimmed, shaped, evenly graded and re-compacted to not less than 95% of the soils maximum unit weight as determined by the AASHTO T-180 test. The Contractor shall properly dispose of all excess materials.

Backfill areas of Subgrade Undercutting, Type II with Granular Material Class II or such other such material as directed by the Engineer. Backfill areas of Subgrade Undercutting, Type IV with 21AA dense-graded aggregate as directed by the Engineer. Type of Subgrade Undercutting used shall be approved by the Engineer.

**d. Measurement and Payment.** The completed work, as described, will be measured and paid for at the contract unit price for the following pay item:

<u>Pay Item</u>	<u>Pay Unit</u>
Subgrade Undercutting, Type II.....	Cubic Yard
Subgrade Undercutting, Type IV.....	Cubic Yard

Basis of payment shall be as described in subsection 205.04 of the MDOT 2020 Standard Specifications for Construction except as herein modified.

DETAILED SPECIFICATION  
FOR  
**DRAINAGE STRUCTURE COVERS**

AA:MGN  
WT:CGT:VCM:AJK

1 of 2

11/19/15  
11/19/2022

- a. Description.-** This work shall consist of furnishing drainage structure covers as detailed on the plans and as specified herein.

Type of Casting	MDOT Designation	EJ Casting No.	Neenah Casting No.
Storm Manhole and Water Gate Well Frame and Cover	Q	1040Z w/1040A Logo Cover*	R-1642 w/Type C Cover*
Barrier Curb Inlet Frame and Cover	K	7045Z w/7050 T2 Back w/7045 M1 Grate	R-3031-B w/Type S Grate
Barrier Curb Large Capacity Inlet Frame and Cover	K	7035Z w/7030 T6 Back w/7030 M2 Grate	N/A
Gutter Inlet Frame and Cover	R	5080Z w/Type 5000M2 Grate	R-3448C, w/Type S Grate
Gutter Large Capacity Inlet Frame and Cover	R	7034Z w/7034 M Grate	N/A
Mountable Curb Inlet Assembly	C	7045Z w/ 7060 T1 Back w/ 7045 M1 Grate	N/A
Yard Drain (Bee Hive) Frame and Cover	E	1040Z, w/1040 02 Grate	R-2560-E1
Water Valve Box Assembly in Pavement	Mon Box	Please See Below	N/A
Monument Box Assembly	Mon Box	8360Z w/ 8360A3 Cover	N/A
Suggested Monument Box	Mon Box	2966Z w/ 2965A Cover	

DETAILED SPECIFICATION  
FOR  
**DRAINAGE STRUCTURE COVERS**

AA:MGN  
WT:CGT:VCM:AJK

2 of 2

11/19/15  
11/19/2022

Suggested Sanitary Manhole Frame and Cover	Q	1040-1ZPT w/ 1040AGS Logo Cover*  In Flood Prone Areas: 1040-ZPT w/ 1040AGSPT Cover	
*Each cover shall have "Sanitary", "Storm," or "Water" cast in the surface, whichever is applicable. Sanitary sewer covers for flood prone areas shall be utilized where shown on the Plans or as directed by the PSAA. Frames and covers must have machined bearing surfaces.			

- Water Valve Box Assembly in Pavement  
 \*4" to 6" Valves: Base #4 w/ 8550,8560,6800 Set  
 \*8" to 12" Valves: Base #6 w/ 8550,8560, 6800 Set  
 \*16"and Larger: Base #160 w/ 8550,8560, 6800 Set

- b. Materials.-** The materials used for this work shall conform to Section 908.05 of the Michigan Department of Transportation 2020 Standard Specifications for Construction except as specified herein.
- c. Construction Methods.-** The construction methods shall be as specified in the related items of work for which the drainage structure covers are provided.
- d. Measurement and Payment.-** The completed work as measured shall be paid at the contract unit price for the following contract items (pay items):

<u>(Contract Item) Pay Item</u>	<u>Pay Unit</u>
Dr Structure Cover, Type ____, Special.....	Each

Payment for this item of work shall include all labor, materials and equipment needed to furnish the drainage structure cover.

DETAILED SPECIFICATION  
FOR  
**6 INCH, WRAPPED UNDERDRAIN**

NCI:AK  
WT:AJK:CGT

1 of 4

11/19/15  
11/19/22

**a. Description.-** The work shall include installing 6-inch geotextile-wrapped perforated or slotted roadway underdrain in a 18-inch wide trench, using 2NS sand for bedding and backfill, and compacting the backfill material to 95% of its maximum unit weight.

The work also includes installing 6-inch, high density polyethylene (HDPE) underdrain, bank (for the purposes of this project a “curb drain”) in a 18-inch wide trench, using MDOT Class II Granular Material and other approved material for bedding and backfill as shown on the plans.

**b. Material.-** The materials shall meet the requirements specified in Section 404 of the 2020 MDOT Standard Specifications for Construction, and as specified herein:

Fine Aggregate, 2NS .....902  
Underdrain Pipe, Perforated or Slotted .....909.07.B

High Density Polyethylene (HDPE) Pipe (Curb Drain, 6”)

High Density Polyethylene Pipe (HDPE) shall be six inches in diameter and have a solid green shell. The HDPE pipe shall be manufactured from high-density PE 3408 resin, having a dimension ratio (DR) of 17 per ASTM F714 or approved equal.

All pipe shall be of virgin material. No rework except that obtained from the manufacturer’s own production of the same formulations shall be used. The pipe shall be homogeneous throughout and shall be free of visible cracks, holes, foreign material, blisters, or other deleterious faults. If new pipe and fittings become damaged before or during installation, it shall be repaired as recommended by the manufacturer or replaced as required by the Engineer at the Contractor’s expense, before installation.

Any section of the pipe with a gash, blister, abrasion, nick, scar, or other deleterious fault greater in depth than 10% of the wall thickness shall be discarded. However, a defective area of the pipe may be cut out and the joint fused in accordance with the procedures stated herein. In addition, any section of the pipe having other defects such as concentrated ridges, discoloration, excessive spot roughness, pitting, variable wall thickness, or any other defect of manufacturing or handling as determined by the Engineer shall be discarded.

A plastic coated, solid core, copper tracer wire designated, as 1/C, #10 THHN or approved equal, will be installed along with the curb drain as it is constructed.

All pipe furnished shall be accompanied by the manufacturer's certificate of test showing conformity with the Specifications. Each certificate shall identify a specific lot



DETAILED SPECIFICATION  
FOR  
**6 INCH, WRAPPED UNDERDRAIN**

NCI:AK  
WT:AJK:CGT

2 of 4

11/19/15  
11/19/22

number, quantity of pipe, and show actual test results for the lot furnished. These certificates shall be submitted to the Inspector at the time of unloading.

All pipe furnished shall be subject to inspection on arrival at the job site by the Engineer. The purpose of the inspection shall be to cull and reject pipe or fittings that, independent of physical tests specified under the standard specifications designated herein, fail to conform to the requirements of these Specifications.

The Contractor shall notify the Engineer sufficiently in advance so that an Inspector may be on the job during the unloading of materials. A minimum notice of 24 hours is required for such unloading and inspection.

Rejected pipe shall be plainly marked by the Inspector and immediately removed from the site of the work by the Contractor, without no additional cost.

Geotextile (Filter Fabric) - The geotextile fabric for encasing the roadway underdrain pipe shall be an approved material such as nylon, polypropylene, fiberglass, or polyester and shall be either woven, heat bonded, knitted or of continuous fibers. The geotextile shall completely cover and be secured to the pipe. In an unstretched condition, knitted polyester fabrics shall weigh at least 3.0 ounces per square yard and all other geotextiles shall weigh at least 3.5 ounces per square yard. The fabric shall be strong and tough and have a porosity such that the fabric will retain soil particles larger than 0.106 mm (No. 140 sieve) and shall pass aggregate particles finer than 0.025 mm. Geotextiles shall be stored and handled carefully and in accordance with the manufacturer's recommendations and shall not be exposed to heat or direct sunlight to such extent as to significantly affect its strength or toughness. Torn or punctured geotextiles shall not be used.

**c. Pipe Jointing.-** The polyethylene pipe shall be assembled and joined on-site above the ground using the butt-fusion method. Threaded or solvent-cement joints and connections are not permitted. Electro-fusion fittings may be used where necessary at no additional cost to the City. All equipment and procedures used shall be in strict compliance with the manufacturer's recommendations.

The butt-fused joint shall have true alignment and shall have uniform rollback beads resulting from the use of proper temperature and pressure. The joint shall be allowed adequate cooling time before removal of pressure. The fused joint shall be watertight and shall have tensile strength equal to that of the pipe. All joints shall be subject to acceptance by the Engineer prior to pipe placement. All defective joints shall be cut out and replaced at no cost to the project.

DETAILED SPECIFICATION  
FOR  
**6 INCH, WRAPPED UNDERDRAIN**

NCI:AK  
WT:AJK:CGT

3 of 4

11/19/15  
11/19/22

**d. Construction Methods.-** Geotextile-wrapped underdrain for subbase drainage and the 6" HDPE underdrain, bank (curb drain), shall be installed as shown on the plans and as specified in Section 404 of the 2020 MDOT Standard Specifications for Construction, with the following exceptions and additions:

1. The trench shall be constructed to have a minimum width of 18 inches and the underdrain shall be installed at the line grade and depth as indicated on the plans. The contractor shall maintain line and grade by means of a laser.
2. The 6" wrapped underdrain trench shall then be backfilled with 2NS Fine Aggregate compacted to 95% of its maximum unit weight. The first lift of backfill material shall be placed at a maximum thickness of 6 inches. The second and subsequent lifts, or portions thereof, shall be placed at a maximum thickness of 12 inches up to an elevation level with the bottom of the existing aggregate base course, or as directed by the Engineer.
- 2a. The trench for the curb drain shall be a combination of MDOT Class II Granular material compacted to 95% of its maximum unit weight and Engineer-approved material free of organics and other deleterious materials compacted to 90% of its maximum dry density as shown on the plans and as approved by the Engineer.
3. Upgrade ends of the pipe shall be closed with suitable plugs to prevent entrance of any material. All couplings, tees and other fitting shall be manufactured and installed so as to prevent infiltration of any material. If during the course of construction, existing edge drains are encountered, their ends shall be plugged to the satisfaction of the Engineer such that material can not enter the pipe(s).
4. Downgrade ends of the pipe shall generally be tapped into existing or new drainage structures. However, it may be necessary to tap underdrain into either existing or new storm sewer, or into existing or new inlet leads as directed by the Engineer.
5. The trench bottom and edge drain shall be constructed to the percent of grade indicated on the plans or as determined by the Engineer, with the minimum percent of grade being 0.5%. In addition, the underdrain shall be constructed to have a minimum cover, from top of pipe to finished pavement grade, of 36 inches.
6. During the construction of underdrain runs, it may be necessary to terminate construction due to conflicts with buried obstructions or at such time when the minimum cover is reached. The Engineer will review conflicts on a case by

DETAILED SPECIFICATION  
FOR  
**6 INCH, WRAPPED UNDERDRAIN**

NCI:AK  
WT:AJK:CGT

4 of 4

11/19/15  
11/19/22

case basis and make a decision on whether to continue installing pipe or terminate runs prematurely. The Contract Unit Price will not be adjusted, or additional payments made, for changes in the contract quantity due to Engineer ordered field changes associated when buried obstructions are encountered.

**e. Measurement and Payment.-** The completed work as measured for "6 inch, Wrapped Underdrain" and "6 inch, Wrapped Underdrain" will be paid for at the contract unit price for the following contract item (pay item):

<u>Contract Item (Pay Item)</u>	<u>Pay Unit</u>
6 inch, Wrapped Underdrain .....	Foot

"6 inch, Wrapped Underdrain" will be measured in length by feet and will be paid for at the contract unit price, which price shall be payment in full for all labor, equipment and material needed to accomplish this work.

The unit price shall include the cost of the 6-inch perforated, slotted, or HDPE pipe (as appropriate), geotextile wrap, pipe fittings and/or plugs, furnishing 2NS or Class II granular bedding and backfill material (as appropriate), compaction of the trench backfill, taps to new and existing drainage structures, storm sewers, or inlet leads, all excavation, final trimming required to meet the dimensions of the typical and specific cross-sections, and the disposal of all surplus excavated materials.

DETAILED SPECIFICATION  
FOR  
**SUBBASE AND AGGREGATE BASE**

AA:MGN  
WT:VCM:CGT:AJK

1 of 2

11/17/15  
11/19/22

**a. Description.-** This work shall consist of constructing subbase and/or aggregate base courses, on either a prepared subgrade or subbase as indicated on the Plans or where directed by the Engineer. This work shall be performed in accordance with Sections 301, 302, and 307 of the 2020 MDOT Standard Specification for Construction except as specified herein.

**b. Materials.-** The material used for this work shall meet the requirements of Sections 301, 302, 307, and 902 of MDOT 2020 Standard Specification for Construction, except that the aggregate base shall be either 21-AA limestone (permanent applications) or 22-A (temporary pavement applications) with a maximum loss by washing of 8% and the subbase shall be either 2NS Sand or Class II Granular Material as shown on the plans.

**c. Construction Method.-** Subbase, aggregate base courses, and approaches shall not be placed when there are indications that the mixture may become frozen before the maximum unit weight is obtained, and in no case shall they be placed on a frozen subbase or subgrade.

The subbase and subgrade shall be shaped to the crown and grade specified on the plans and maintained in a smooth condition. The top of the subbase shall be placed to within  $\frac{1}{2}$  inch below and  $\frac{1}{2}$  inch above plan grade. The top of the aggregate base shall be placed to within  $\frac{1}{2}$  inch below and  $\frac{1}{4}$  inch above plan grade. Variations within this tolerance shall be gradual. If in the opinion of the Engineer, the Contractor's equipment is causing or will cause any ruts in or damage to the subbase or subgrade, the equipment shall not be permitted on the subbase or subgrade.

Should the subgrade, subbase or aggregate base become damaged due to the Contractor's equipment or by local traffic, the subgrade, subbase, or aggregate base course shall be restored to the condition required by the Specifications without additional compensation to the Contractor.

No pavement course, concrete curb and gutter, or concrete driveway opening shall be placed until the subbase has been compacted to not less than 95 percent, and aggregate base course to not less than 98 percent of their respective maximum dry densities and until a "Permit to Place" has been issued by the Engineer.

Base course aggregate shall be handled and/or stockpiled on-site in a manner that minimizes segregation. Base course aggregate shall be deposited from trucks or through a spreader in a manner that will minimize segregation of material and that is approved by the Engineer. The re-handling of base course aggregate by the Contractor will not be considered sufficient cause to allow the material to become segregated. The Contractor

DETAILED SPECIFICATION  
FOR  
**SUBBASE AND AGGREGATE BASE**

AA:MGN  
WT:VCM:CGT:AJK

2 of 2

11/17/15  
11/19/22

may be required to wet the materials prior to and/or during placement to minimize segregation and to aid in compaction of the material should it be necessary.

All structures, including manholes, valve boxes, inlet structures and curbs shall be protected from damage and contamination by debris and construction materials. Structures shall be maintained clean of construction debris and properly covered at all times during the construction.

The Contractor may be charged for the cleaning by others of accumulated construction debris in the utility structures, and damages resulting from the uncleaned structures.

**d. Measurement and Payment.-** The completed work as measured will be paid for at the contract unit prices for the following contract items (pay items):

<b><u>Contract Item (Pay Item)</u></b>	<b><u>Pay Unit</u></b>
Subbase, CI II CIP .....	Cubic Yard
Aggregate Base Course, 21AA, Modified .....	Ton

“Subbase, CI II CIP” will be measured by volume in cubic yards. “Aggregate Base Course, 21AA, Modified” will be measured by mass in tons. The items of work will be paid for at the contract unit prices, which shall be payment in full for all labor, material and equipment needed to accomplish this work.

The subbase will be calculated using the nominal width and depth of the subbase indicated on the plans.

DETAILED SPECIFICATION  
FOR  
**CONCRETE CURB AND DRIVEWAY OPENINGS**

AA:MGN:JKA  
WT:VCM:AJK:CGT

1 of 3

4/28/2022  
11/19/2022

**a. Description.-** This work shall consist of constructing concrete curb and gutter, and concrete curb openings in accordance with Section 802 of the MDOT 2020 Standard Specifications for Construction, as shown on the plans, and as specified herein.

**b. Materials.-** The materials shall meet the requirements as specified in Section 802.02 of the 2020 MDOT Standard Specifications and as specified herein:

Driveway Opening, Conc., Detail M, P-NC shall be Grade P-NC Concrete (658 lbs/cydcement content). Driveway Opening, Conc, Detail L, 3500 shall be Grade 3500 Concrete (526lbs/cyd cement content.). All concrete mixtures shall be made with 6AA coarse aggregate.

All other concrete curb and gutter specified herein shall be grade 3500 with 6AA coarse aggregate. The Contractor may elect to add GGBFS to 3500 mixtures in accordance with the requirements of the contract documents. No additional payment will be made for concrete mixtures containing GGBFS.

All concrete mixtures shall contain 6AA coarse aggregates which are either natural orlimestone and meet the requirements of Section 902.

It shall be the Contractor's sole responsibility to propose specific concrete mix designs which meet the requirements of this Detailed Specification and the contract documents.

**c. Construction Methods.-** Curb and Gutter, Conc, Det F4, Special and Curb and Gutter, Conc, Det F6, Special shall be constructed as shown in the MDOT Standard Plans R-30 series, as detailed in this specification, and as shown in the plans.

All driveway openings shall be constructed in accordance with MDOT Standard DetailR-29-I for Concrete Driveway Openings, Detail "M."

Curb and Gutter, Conc, Match Existing, Special shall be constructed as detailed in this specification and as shown in the plans.

Mountable Curb and Gutter shall be constructed as detailed in this specification and in accordance with the City of Ann Arbor detail SD-R-2.

At curb ramp openings for sidewalk ramps, the concrete curb and gutter shall be constructed per ADA specifications and MDOT detail R-28-J.

DETAILED SPECIFICATION  
FOR  
**CONCRETE CURB AND DRIVEWAY OPENINGS**

AA:MGN:JKA  
WT:VCM:AJK:CGT

2 of 3

4/28/2022  
11/19/2022

Expansion joints of the thickness shown on the details shall be placed as directed by the Engineer.

The preparation of the aggregate base course upon which the curb and gutter and drive openings are to be constructed shall be performed in accordance with Section 302 of the 2020 MDOT Standard Specifications.

The concrete curb and gutter and/or driveway openings shall not be constructed on a pedestal or a mound. The aggregate base course shall be constructed the full width of the stage or phase in which concrete curb and gutter or driveway opening is to be constructed.

The concrete items being placed shall not be opened to construction or vehicular traffic until such time as the concrete has reached the required flexural strength. The Contractor shall cast beams in accordance with Section 603.03.B.10, and as approved by the Engineer, and obtain concrete flexural strength in accordance with the requirements of Section 104.11, Table 104-2. Beams cast for open to traffic determinations shall be cured in the same manner and environment as the concrete items which they represent.

Flexural strength beams shall be tested (broken) with a device meeting the approval of the Engineer and be in a state of good repair and shall be calibrated by an accredited testing laboratory or engineering company within a period of two years from the date of the test being performed.

**d. Measurement and Payment.**- The completed work as measured shall be paid for at the contract unit price for the following contract items (pay items):

<u><b>Contract Item (Pay Item)</b></u>	<u><b>Pay Unit</b></u>
Curb and Gutter, Conc, Match Existing, Special.....	Foot
Mountable Curb and Gutter .....	Foot

The pay items will be measured in length by the foot and will be payment in full for all labor, equipment and material needed to properly complete this work.

At curb openings for sidewalk ramps, the concrete curb and gutter (without the curb face) will be measured and paid for at the contact unit price for Curb and Gutter, Conc, Match Existing, Special.

DETAILED SPECIFICATION  
FOR  
**CONCRETE CURB AND DRIVEWAY OPENINGS**

AA:MGN:JKA  
WT:VCM:AJK:CGT

3 of 3

4/28/2022  
11/19/2022

Where the Engineer directs the use of high early strength concrete for pay items that are not designated as "P-NC," the additional cement shall be paid for separately. No additional payment will be made for cement for pay items that are designated "P-NC."



CITY OF ANN ARBOR  
DETAILED SPECIFICATION  
FOR  
**MAINTENANCE GRAVEL, 21AA, MODIFIED**

WT:VCM:CGT

1 of 2

11/19/22

**a. Description.-** This work shall consist of constructing temporary Maintenance Gravel on either a prepared subgrade or an existing aggregate surface as indicated on the Plans or where directed by the Engineer. This work shall be performed in accordance with Sections 306 of the 2020 MDOT Standard Specification for Construction except as specified herein.

**b. Materials.-** The material used for this work shall meet the requirements of Section 902 of MDOT 2020 Standard Specification for Construction, except that the Maintenance Gravel shall be 21AA.

**c. Construction Method.-** Perform the work in accordance with the requirements of Section 306 of the 2020 MDOT Standard Specification for Construction except as specified herein.

The Contractor shall blade and/or scarify and blade the existing aggregate surface in order to remove existing irregularities within the grade prior to placing the Maintenance Gravel material.

The material shall be handled and/or stockpiled in a manner that minimizes segregation. Maintenance Gravel aggregate shall be deposited from trucks or through a spreader in a manner that will minimize segregation of material and that is approved by the Engineer. The re-handling of the aggregate by the Contractor will not be considered sufficient cause to allow the material to become segregated. The Contractor may be required to wet the materials prior to and/or during placement to minimize segregation and to aid in compaction of the material should it be necessary.

All structures, including manholes, valve boxes, inlet structures and curbs shall be protected from damage and contamination by debris and construction materials. Structures shall be maintained clean of construction debris and properly covered at all times during the construction.

The Contractor may be charged for the cleaning by others of accumulated construction debris in the utility structures, and damages resulting from the uncleaned structures.

**d. Measurement and Payment.-** The completed work as measured will be paid for at the contract unit prices for the following contract items (pay items):

<u>Contract Item (Pay Item)</u>	<u>Pay Unit</u>
Maintenance Gravel, 21AA, Modified .....	Ton

"Maintenance Gravel, 21AA, Modified" will be measured by weight in tons by certified delivery tickets submitted at the time of delivery. The item of work will be paid for at the contract unit price, which shall be payment in full for all labor, material and equipment needed to accomplish this work.

The provisions of Section 306.04 regarding excess moisture content, moisture corrections, and pay weights shall apply to this item of work.

DETAILED SPECIFICATION  
FOR  
CONCRETE SIDEWALK, RAMP AND DRIVEWAY

WT:VCM:CGT	1 of 3	11/19/22
------------	--------	----------

**a. Description.-** This work shall consist of constructing concrete sidewalk, ramp, or drive approaches of the types as indicated on the plan sheets, as detailed in the specifications, or as directed by the Engineer. It shall also include constructing concrete drive approaches of the types as indicated on the plan sheets, as detailed in the specifications, or as directed by the Engineer. All work shall be in accordance with Section 801 and 803 of the 2020 MDOT Standard Specifications for Construction and as specified herein.

All ADA ramps shall be installed with detectable warning units. Reference the Detailed Specification entitled "Detectable Warning Tiles" for additional requirements.

**b. Materials.-** The materials shall meet the requirements as specified in the 2020 MDOT Standard Specifications and as required herein. The grade of concrete for items designated as "P-NC" shall be Grade P-NC concrete (658 lbs/yd<sup>3</sup> cement content) as specified in Section 601 of the 2020 MDOT Standard Specifications.

The grade of concrete for all remaining items covered by this Detailed Specification shall be grade 3500 as specified in Section 601 of the 2020 MDOT Standard Specifications for Construction. The Contractor may elect to add GGBFS to 3500 mixtures in accordance with the requirements of the contract documents. No additional payment will be made for concrete mixtures containing GGBFS.

All concrete mixtures shall contain 6AA coarse aggregates which are either natural or limestone and meet the requirements of Section 902 of the 2020 Michigan Department of Transportation Standard Specifications for Construction.

It shall be the Contractor's sole responsibility to propose specific concrete mix designs which meet the requirements of this Detailed Specification.

**c. Construction Methods.-** The Contractor is responsible to construct all sidewalk, sidewalk ramps, curbs, and all other concrete items within ADAAG compliance. All sidewalk and curb ramps must be constructed in accordance with MDOT Standard Detail R-28 series.

Where concrete sidewalk and/or ADA compliant ramps are to be placed, they shall be placed on a minimum of 4 inches of Granular Material, Class II, compacted to 95% of its maximum dry density.

Concrete drive approaches shall be placed on either aggregate base course or a sand sub-base as shown on the plans or as directed by the Engineer. The required density of

DETAILED SPECIFICATION  
FOR  
**CONCRETE SIDEWALK, RAMP AND DRIVEWAY**

WT:VCM:CGT	2 of 3	11/19/22
------------	--------	----------

the material underlying the concrete drive approach shall be that of the material on which it is placed and required by those specifications.

Prior to placing any concrete, the subgrade shall be completed and trimmed to final elevation. If a cold joint is required, the existing concrete is to be cleaned with compressed air to expose the aggregate in the concrete.

Where indicated on the plans to be performed, the Contractor shall also sawcut curbsto provide openings for sidewalk ramps as indicated. The Engineer shall define the extent of sawcutting. This work will not be paid for separately, but shall be included in the corresponding price of the ADA ramp to be placed.

The concrete items being placed shall not be opened to construction or vehicular traffic until such time as the concrete has reached the required compressive strength. The Contractor shall cast cylinders in accordance with Section 601 of the 2020 MDOT Standard Specifications, and as approved by the Engineer, and obtain concrete compressive strength in accordance with the requirements of Section 104.11, Table 104-1. Cylinders cast for open to traffic determinations shall be cured in the same manner and environment as the concrete items which they represent.

Compressive strength cylinders shall be tested (broken) with a device meeting the approval of the Engineer and be in a state of good repair and shall be calibrated by an accredited testing laboratory or engineering company within a period of two years from the date of the test being performed.

All ADA ramps shall be installed with detectable warning units. Reference the Detailed Specification entitled "Detectable Warning Tiles" for additional requirements.

**d. Measurement and Payment.**- The completed work as measured for the following pay items will be paid for at the contract unit prices for the following contract items (pay items):

<u>Contract Item (Pay Item)</u>	<u>Pay Unit</u>
Sidewalk, Concrete, __ inch, Special.....	Square Foot
Sidewalk Ramp, Concrete, __ inch, Special .....	Square Foot

The above items will be measured by area in square feet and be paid for at their respective contract unit price, which price shall be payment in full for all labor, equipment and material needed to accomplish this work. The unit price shall also include all costs associated with sawcutting curbs to provide openings for ADA sidewalk ramps as indicated on the plans.

DETAILED SPECIFICATION  
FOR  
**CONCRETE SIDEWALK, RAMP AND DRIVEWAY**

WT:VCM:CGT	3 of 3	11/19/22
------------	--------	----------

Where the Engineer directs the use of high early concrete for pay items that are not designated as "P-NC," the additional cement shall be paid for separately. No additional payment will be made for cement for pay items that are designated "P-NC"

DETAILED SPECIFICATION  
FOR  
**DETECTABLE WARNING TILES**

WT:VCM:CGT

1 of 3

11/19/22

**a. Description.-** This work shall consist of furnishing and installing cast in place detectable warning units in compliance to the Americans with Disability Act (ADA). All work shall be in accordance with the Detailed Specification for “Concrete Sidewalk, Ramp, and Driveway,” Section 803 of the MDOT 2020 Standard Specifications for Construction, MDOT Standard Detail R-28 series, as indicated on the plans, and as modified herein.

**b. Related Documents.-** Americans with Disabilities Act (ADA) Title 49 CFR Transportation, Part 37.9 Standards for Accessible Transportation Facilities, Appendix A, Section 4.29.2 Detectable Warnings on Walking Surfaces

American Society for Testing and Materials (ASTM) Test Methods B117, C1028, D543, D570, D638, D695, D790, D2486, D2565, D5420, and E84.

**c. Submittals.-** Submit manufacturer’s literature describing products, installation procedures and maintenance instructions. Provide cast-in-place detectable surface tiles and accessories as produced by a single manufacturer.

Samples for Verification Purposes: Submit two (2) tile samples minimum 6” x 8” of the kind proposed for use. Samples shall be properly labeled and shall contain the following information: Name of Project; Submitted by; Date of Submittal; Manufacture’s Name; Catalog No.; and Date of Fabrication.

Material Test Reports: Submit current test reports from a qualified, independent, testing laboratory indicating that materials proposed for use are in compliance with requirements and meet the properties indicated. The required tests listed elsewhere in this Detailed Specification shall be performed by a certified and qualified independent testing laboratory on a cast-in-place tactile warning system. All test reports submitted shall be certified by the testing laboratory and shall clearly state that all tests were completed within 5 years of the date of the submittal. The manufacturer shall certify in writing that the materials provided to the project are manufactured with the same materials and manufacturing procedures as those used in the materials on which the test were performed.

**c. Materials.-** The detectable warning tiles shall be colored as Federal Number 22144 (frequently referred to as “Colonial Red” or “Brick Red”). The detectable warning tiles shall meet the following material properties, dimensions, and tolerances using the most current test methods:

1. Water Absorption: Not to exceed 0.35% when tested in accordance with ASTM- D570
2. Slip Resistance: 0.80 minimum combined wet/ dry static coefficient of friction on top domes and field area, when tested in accordance with ASTM C1028.

DETAILED SPECIFICATION  
FOR  
**DETECTABLE WARNING TILES**

WT:VCM:CGT	2 of 3	11/19/22
------------	--------	----------

3. Compressive Strength: 18,000 psi minimum, when tested in accordance with ASTM D695.
4. Tensile Strength: 10,000 psi minimum, when tested in accordance with ASTM D638.
5. Flexural Strength: 24,000 psi minimum, when tested in accordance with ASTM D790.
6. Chemical Stain Resistance: No reaction to 1% hydrochloric acid, urine, chewing gum, soap solution, motor oil, bleach, calcium chloride, when tested in accordance with ASTM D543 or D1308.
7. Wear Depth: 300 minimum, when tested in accordance with ASTM C501.
8. Flame Spread: 25 maximum, when tested in accordance with ASTM E84.
9. Gardner Impact: 50 in.-lbs. minimum, when tested in accordance with Geometry "GE" of ASTM D5420.
10. Accelerated Weathering of Tile when tested by ASTM-G155 or ASTM G151 shall exhibit the following result- $\Delta E < 6.0$  as well as no deterioration, fading or chalking of surface when exposed to 3000 hours minimum exposure.
11. Wheel Loading: The cast in place tile shall be mounted on a concrete platform with a ½" airspace at the underside of the tile top plate then subjected to the specified maximum load of 10,400 lbs., corresponding to an 8,000 lb individual wheel load and a 30% impact factor. The tile shall exhibit no visible damage at the maximum load of 10,400 lbs using AASHTO-HB17 single sheet HS20-44 loading "Standard Specifications for Highways and Bridges."
12. Salt and Spray Performance of Tile and Adhesive System when tested to ASTM-B117 not to show any deterioration or other defects after 100 hours of exposure

**d. Construction Methods.-** Installer's Qualifications: Engage an experienced Installer who has successfully completed tile installations similar in material, design, and extent to that indicated for this Project.

The contractor shall follow manufacturer specifications for installation, except where they conflict with MDOT Standard Detail R-28 series, or other project requirements.

- c. Measurement and Payment.-** The completed work as measured for the following pay items will be paid for at the contract unit prices for the following contract items (pay items):

DETAILED SPECIFICATION  
FOR  
**DETECTABLE WARNING TILES**

WT:VCM:CGT	3 of 3	11/19/22
------------	--------	----------

**Contract Item (Pay Item)**

**Pay Unit**

Detectable Warning Surface, Modified..... Foot

The unit price for this item shall include all labor, material, and equipment costs required to complete the work.



CITY OF ANN ARBOR  
DETAILED SPECIFICATION  
FOR  
**BRICK PAVERS REMOVE, SALVAGE, AND RESTORE**

WT:AJK

1 of 3

11/9/2022

**Description**

This work shall be completed in accordance with the requirements of sections 302, 602, 803, and 913 of the Michigan Department of Transportation 2020 Standard Specifications for Construction, except where those sections conflict with this Detailed Specification, with the details as shown on the plans, and this Detailed Specification.

This work shall consist of furnishing all labor, tools, equipment, and materials to remove, salvage, clean, sort, and securely store brick pavers, construct a 4-inch thick perforated concrete base on a prepared subbase, install 1 inch of sand bedding, and reinstall brick pavers in a pattern which matches the existing where specified on the plans and/or as directed by the Engineer.

**a. Materials**

The Contractor shall furnish materials which meet the requirements specified in the sections of the MDOT 2020 Standard Specifications for Construction listed below:

Subbase Material – dense-graded aggregate 21AA or granular material Class II as specified in section 902.

Weep Hole Fill – coarse aggregate 29A or open-graded aggregate 34R as specified in section 902.

Sand Bedding – fine aggregate 2NS as specified in section 902.

Brick Pavers – masonry units as specified in section 913 which match the existing in kind.

Concrete Base – concrete Grade 3500 as specified in section 1004. Quality Control shall be provided in accordance with section 1002 at the direction of the Engineer. Quality Assurance in accordance with section 1004 shall be the basis for concrete acceptance.

Joint Sand – the Contractor shall provide polymeric sand commonly used for brick paver joints.

CITY OF ANN ARBOR  
DETAILED SPECIFICATION  
FOR  
**BRICK PAVERS REMOVE, SALVAGE, AND RESTORE**

WT:AJK

2 of 3

11/9/2022

**b. Construction**

The Contractor shall carefully remove existing brick pavers, clean, transport, and securely store them until they are reinstalled. Upon removal, the Contractor shall assume possession and responsibility for the integrity of the brick pavers. It shall be the Contractor's sole responsibility to indicate to the Engineer where existing brick pavers are missing or damaged in advance of removal operations.

Any brick pavers misplaced or damaged through removal, salvage, store, and/or construction operations shall be replaced in kind at the Contractor's expense. Brick pavers found to be missing or damaged through other means shall be replaced in kind at no additional cost to the City of Ann Arbor.

It shall be the Contractor's responsibility to provide a safe and secure storage facility for the removed brick pavers.

After existing base materials are removed through other operations, the Contractor shall allow the Engineer time to inspect the existing subbase for reuse.

The Contractor shall excavate and install subbase material as directed by the Engineer at a minimum of 4 inches thick compacted to at least 95% of the maximum unit weight.

The Contractor shall pour a 4-inch thick concrete base. The Contractor shall perforate the concrete base with 2-inch diameter weep holes which extend to a depth to the surface of the subbase. 1 perforation per square foot of the concrete base shall be required. Weep holes shall be filled to the top with 29A or 34R.

The Contractor shall construct a level 1-inch thick sand bed.

Brick installation is to match the pattern of the existing adjacent brickwork. (see patterns below). Use string lines or other devices as needed to insure straight joint lines and final surface elevations. Butt paving units tight to adjacent concrete paving and to each other. Protect newly laid pavers at all times by plywood panels on which workers stand. Use a plate vibratory compactor (min. 5,000 lbs compaction force) and make a minimum of three (3) passes to set paving units in leveling course prior to filling joints. Protect pavers from chipping and cracking during compaction.

Spread fine aggregate joint filler over paver surface and broom into joints, and mist lightly with water to settle sand into joints. Allow to surface dry and repeat process, as required, to fill joints completely. Remove excess sand upon completion.

The Contractor shall take any necessary precautions to prevent damage to pavers during removal and replacement. The Contractor is not entitled to any additional compensation for such replacement of damaged pavers.

The Contractor shall clean off and dispose of all debris, including excess sand, from brick

CITY OF ANN ARBOR  
 DETAILED SPECIFICATION  
 FOR  
**BRICK PAVERS REMOVE, SALVAGE, AND RESTORE**

WT:AJK

3 of 3

11/9/2022

pavers and adjacent surfaces after construction.

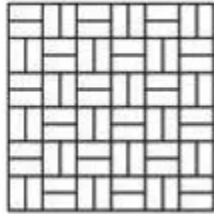

*Pattern 1: Basket Weave*

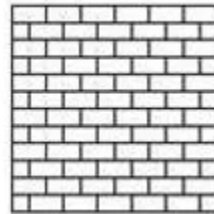

*Pattern 2: Running Bond*

**c. Measurement and Payment**

The work completed and measured for Brick Pavers Remove, Salvage, and Restore shall be paid for at the contract unit price for the following pay items:

<u>Contract Item (Pay Item)</u>	<u>Unit</u>
Conc Base, 4 inch, Perforated .....	Square Foot
Brick Pavers, Rem, Sort, and Salv .....	Square Foot
Brick Pavers, Install Salvaged.....	Square Foot

Payment for all existing base removals, excavation, and installed subbase materials shall be included in payment for other pay items.

Cleaning and storing brick pavers, weep hole fill, transportation, sand bedding, joint sand, and cleaning and disposing of debris shall not be paid separately but shall be included in the payment for Brick Pavers, Rem, Sort, and Salvage and Brick Pavers, Install Salvaged.

The unit price for these items of work shall include all labor, material, and equipment costs to perform all the work.

CITY OF ANN ARBOR  
SPECIAL PROVISION  
FOR  
**TRENCH DRAIN**

WT:AJK

1 of 2

11/9/2022

**a. Description**

This work shall be completed in accordance with the requirements of sections 602 and 803 of the Michigan Department of Transportation 2020 Standard Specifications for Construction, except where those sections conflict with this special provision, with the details as shown on the plans, and this special provision.

This work shall consist of furnishing of furnishing all labor, tools, equipment, and material required to remove a steel plate (approximately 10' x 1'), construct an open channel concrete drainage feature and outlet (Trench Drain), and install a grate such that it spans the entire length of the channel and covers the topside of the outlet.

This is a lump sum item for which the Engineer has not identified the associated item materials and quantities required to complete this work. It shall be the Contractor's responsibility to identify all materials and quantities required to complete this work in advance of construction operations.

**b. Materials**

The Contractor shall furnish materials which meet the requirements specified in the sections of the MDOT 2020 Standard Specifications for Construction listed below:

Subbase Material – dense-graded aggregate 21AA or granular material Class II as specified in section 902.

Trench Drain – concrete Grade 3500 as specified in section 1004. Quality Control shall be provided in accordance with section 1002 at the direction of the Engineer. Quality Assurance in accordance with section 1004 shall be the basis for concrete acceptance.

Steel Grate – the furnished grate shall meet ADA requirements and the City of Ann Arbor specifications and shall be an East Jordon 6861M Trench Grate or approved equivalent.

**c. Construction**

In advance of removals, the Contractor shall closely investigate the existing steel plate and channel to determine the requirements to properly facilitate this work. The purpose of this investigation includes determining the thickness, grade, and dimensions of the steel plate, determine what type of fasteners to use, and determine the dimensions of the channel and outlet.

After the existing channel is removed through other operations, the Contractor shall allow the Engineer time to evaluate the existing subbase materials for reuse.

The Contractor shall excavate and place subbase materials as directed by the Engineer at a minimum of 4 inches thick compacted to at least 95% of the maximum unit weight.

CITY OF ANN ARBOR  
SPECIAL PROVISION  
FOR  
**TRENCH DRAIN**

WT:AJK

2 of 2

11/9/2022

The Contractor shall construct a concrete box channel and outlet at the proposed elevations and install any hardware that is required to be embedded in the concrete structure. The Contractor shall finish the surface of the trench drain with a smooth finish.

The contractor shall ensure that the channel and outlet provide positive drainage to the roadway.

The Contractor shall install the grate so that it spans the entire length of the channel and the top of the plate is flush with all adjacent pavements, except at the roadway.

The Contractor shall ensure that the plate and trench drain are free of any trip and fall hazards for pedestrians.

The Contractor shall ensure that the steel plate does not extend beyond the limits of the adjacent curb and does not extend into the roadway.

**d. Measurement and Basis of Payment**

The work completed and measured for Trench Drain shall be paid for at the contract unit price for the following pay items:

<u>Contract Item (Pay Item)</u>	<u>Unit</u>
Trench Drain .....	Lump Sum

Payment for all existing base removals, excavation, and installed subbase materials shall be included in payment for other pay items.

The shaping and finishing of the concrete channel and the furnishment and installation of the steel grate shall not be paid separately, but shall be included in payment for Trench Drain.

The unit price for these items of work shall include all labor, material, and equipment costs to perform all the work.

DETAILED SPECIFICATION  
FOR  
**HMA APPLICATION ESTIMATE**

AA:MGN  
WT:CGT:AJK

1 of 1

10/13/15  
11/19/2022

**a. Description.-** The work shall be performed in accordance with the requirements of Division 5 of the 2020 Michigan Department of Transportation Standard Specifications for Construction, and as herein specified.

**b. Materials.**

STREET NAME	PAY ITEM	HMA MIX	APPLICATION RATE	EST. THICKNESS	PERFORMANCE GRADE	AWI (min)
S. Main St	HMA, 5EML	5EML (top)	220 lb/Syd	2.0"	PG 70-28P	260
	HMA, 4EML	4EML (leveling)	220 lb/Syd	2.0"	PG 70-28P	N/A
	HMA, 3C	3C (base)	330 lb/Syd	3.0"	PG 70-28P	N/A
Hand Patching	Hand Patching, Modified	5EML	110 lb/Syd	Varies	PG 70-28P	260

The Performance Grade asphalt binder range for the HMA mixture shall be as noted above. The Bond Coat material shall be applied in accordance with the requirements of the Detailed Specification entitled "HMA Paving." The uniform rate of application shall be a minimum of 0.05 gallons/yd<sup>2</sup> and be approved by the Engineer. This work will not be paid for separately, but shall be included in the cost of other pay items.

**c. Measurement and Payment.-** The work shall be measured and paid for as provided elsewhere in the contract documents.

DETAILED SPECIFICATION  
FOR  
HMA PAVING, CITY OF ANN ARBOR

AA:MGN  
WT:VCM:CGT:AJK

1 of 5

02/07/14  
11/19/2022

**a. Description.-** Hot Mix Asphalt (HMA) pavement base, leveling, and top courses shall be constructed in accordance with Section 501 of the 2020 MDOT Standard Specifications for Construction, except as modified herein, and as directed by the Engineer.

**b. Construction Methods.-**

**Equipment-** All equipment shall conform to Section 501.03.A of the 2020 MDOT Standard Specifications, except as modified herein.

The Contractor shall have a 10 foot long straight edge, rubber-tired backhoe (Case 580 type, or equivalent), air-compressor with the ability to develop a minimum pressure of 100 pounds per square inch and continuous rated capacity of 150 cubic feet per minute of air flow, and jackhammer available during all paving operations. The Contractor shall be required to perform any miscellaneous cleaning, trimming, material removal, and other tasks as required by the Engineer in order to ensure the proper and orderly placement of all HMA materials on this project.

The Contractor shall provide sufficient rollers to achieve the specified asphalt densities.

At various times throughout the work, the Engineer may direct the Contractor to use smaller and/or lighter equipment, and to defer certain work tasks, in order to protect the grade and/or adjacent areas; including hauling units. The Contractor shall not be entitled to any additional compensation for the use of smaller equipment, lighter equipment, or work task deferral.

**Cleaning and Bond Coat application-** Cleaning and bond coat application shall be performed in accordance with Sections 501.03.C and 501.03.D of the 2020 MDOT Standard Specifications, except as modified herein, and as directed by the Engineer.

The Contractor shall furnish and operate throughout the construction period, vacuum-type street cleaning and utility structure cleaning equipment (Vac-All, Vactor, etc.) approved by the Engineer, and when directed by the Engineer, for street cleaning immediately prior to, and for street and utility structure cleaning after any and all paving. The cleaning equipment shall be of sufficient power to remove dust, dirt, and debris from the pavement and from utility structures in and adjacent to the construction area. The vac-all or similar equipment and shall be approved by the Engineer prior to beginning the work. The equipment used shall have an effective means for preventing any dust resulting from the operation from escaping into the air.

DETAILED SPECIFICATION  
FOR  
**HMA PAVING, CITY OF ANN ARBOR**

AA:MGN  
WT:VCM:CGT:AJK

2 of 5

02/07/14  
11/19/2022

The bond coat shall be applied at a minimum rate of 0.05 gallons/yd<sup>2</sup>. Before placing the bond coat, the existing pavement surface shall be thoroughly cleaned. The Contractor shall also thoroughly clean all joints, cracks, and edges to a minimum depth of one inch with compressed air, vac-all type equipment, or other approved mechanical or hand methods, to remove all dirt, debris, and all foreign material.

**HMA Placement-** Placement shall conform to Section 501.03.F of the 2020 MDOT Standard Specifications, except as modified herein, and as directed by the Engineer.

HMA placement shall not commence until a “Permit to Place” (no additional costs are required to obtain this permit) has been issued in writing by the Engineer. The Permit to Place shall be issued after the aggregate base course or the adjacent, underlying layer of pavement section has been approved by the Engineer.

The final structure adjustments must be approved by the Engineer prior to the issuance of the “Permit to Place” for the wearing course.

The top course shall be placed with a ¼” lip at the gutter edge of metal.

All HMA thickness dimensions are compacted-in-place.

**Paving Operation Scheduling** – The Contractor shall schedule the paving operation to avoid longitudinal cold joints that would be required to be left “open” over night.

In all cases, the Contractor shall pave the primary road’s through-traffic lanes (“main line”) first, from point-of-beginning to the point-of-ending. All other paving including, but not limited to; acceleration and deceleration lanes, intersection approaches, and center left-turn lanes shall be paved following completion of main line paving, unless authorized by the Engineer prior to the placement of any pavement.

**Rate of Paver operation** - The rate of the paver’s travel shall be maintained such that the paving operation will be continuous, resulting in no transverse cold joints, but shall never exceed the rate of 50 feet per minute.

The Contractor shall furnish and operate enough material, equipment, and hauling units so as to keep the paving machine(s) moving continuously at all times. Failure to do so shall be cause for the suspension of the paving operation until the Contractor can demonstrate to the satisfaction of the Engineer, that sufficient resources have been dedicated to perform the work in accordance with the project specifications.



DETAILED SPECIFICATION  
FOR  
HMA PAVING, CITY OF ANN ARBOR

AA:MGN  
WT:VCM:CGT:AJK

3 of 5

02/07/14  
11/19/2022

**Longitudinal and Transverse Joints-** shall conform to Section 501.03.F of the 2020 MDOT Standard Specifications and as specified herein.

For mainline HMA paving, the width of the mat for each pass of the paver shall be not less than 10.5', nor greater than 15', except as noted in the plans and as directed by the Engineer. The Engineer will direct the layout of all HMA longitudinal joints during construction.

Prior to placing the adjacent paving pass on the leveling and wearing courses of HMA, the Contractor shall cut and remove 6" to 8" of the previously placed pavement at the free edge of the pavement by means of a coultter wheel. The Engineer reserves the right to reject any method(s) for cutting the pavement that does not provide a vertical and satisfactory edge, free of tearing, bending, or other deformations, as determined by the Engineer. Any method(s) employed by the Contractor shall be completely effective. The cut edge shall have a uniform bead of pavement joint adhesive applied to the full-height of the joint. The removal of this HMA material and resulting edge must be approved by the Engineer prior to proceeding with the placement of the succeeding pass of HMA. The base course of HMA and its vertical edge will have bond coat applied in accordance with Section 501.03.D. All costs associated with complying with these requirements will not be paid for separately, but shall be considered to be included in the items of work "HMA, \_\_\_" or "HMA, Approach."

Pavement joint adhesive shall be hot-applied, meet, or exceed, the following properties, and be approved by the Engineer prior to performing HMA placement:

- Brookfield Viscosity, 400°F, ASTM D2669 – 4,000 to 10,000 cp
- Cone Penetration, 77°F, ASTM D5329 – 60 to 100
- Flow, 140°F, ASTM D5329 – 5mm maximum
- Resilience, 77°F, ASTM D5329 – 30% minimum
- Ductility, 77°F, ASTM D113 – 30 cm minimum
- Ductility, 39.2°F, ASTM D113 – 30 cm minimum
- Tensile Adhesion, 77°F, ASTM D5329 – 500% minimum
- Softening Point, ASTM D36 - 170°F minimum
- Asphalt Compatability, ASTM D5329 – pass

**Feather Joints** – shall be constructed so as to vary the thickness of the HMA from zero inches to the required paving thickness at the rate of approximately 1.5" over a distance of 10 feet, or as directed by the Engineer. The Contractor shall rake the larger pieces of aggregate out of feather joints prior to compaction.

DETAILED SPECIFICATION  
FOR  
HMA PAVING, CITY OF ANN ARBOR

AA:MGN  
WT:VCM:CGT:AJK

4 of 5

02/07/14  
11/19/2022

**Butt Joints** - Construction of butt joints, where directed by the Engineer, shall conform to Section 501.03.C.3 and 501.03.C.4 of the 2020 MDOT Standard Specifications, except as modified herein.

When a butt joint is specified or directed to be placed by the Engineer, remove the existing HMA surface to the thickness of the proposed overlay, or full-depth, as directed by the Engineer, for the full width or length of the joint. The HMA material shall be sawcut to the directed depth along the pavement edge or removal line to prevent tearing of the pavement surface. Cut joints that will be exposed in the completed surface must be cut with a saw or a cold-milling machine or other methods approved by the Engineer. Joints that will be covered by HMA must be cut with a saw, a cold-milling machine, or other methods approved by the Engineer.

**Rakers**- the Contractor shall provide a minimum of two rakers during the placement of all wearing and leveling courses.

**Faulty Mixtures** – The Contractor and Engineer shall carefully observe the paving operation for signs of faulty mixtures. Points of weakness in the surface shall be removed or corrected by the Contractor, at his/her sole expense, prior to paving subsequent lifts of bituminous material. Such corrective action may include the removal and replacement of thin or contaminated sections of pavement, segregated HMA, and any sections that are weak or unstable. Once the Contractor or his representative is notified by the Engineer that the material being placed is out of allowable tolerances, or that there is a problem with the paving operation, the Contractor shall stop the paving operation at once, and shall not be permitted to continue placing bituminous material until again authorized by the Engineer. Any costs associated with meeting the requirements specified herein shall not be paid for separately, but shall be included in the item(s) of work being performed at the time the faulty mixture was discovered.

**c. Measurement and Payment.**- Measurement of these HMA paving items shall be by the ton, in place. Unused HMA remaining in trucks after the work is completed shall be returned to the plant and re-weighed, and the corrected weight slip shall be provided to the Engineer. No payment will be made for the unused HMA material. All weight slips must include the type of mixture (codes are not acceptable), as well as vehicle number, gross weight, tare weight and net weight.

Corrective action shall be enforced as described at Division 5 of the 2020 MDOT Standard Specifications for Construction and will be based on the City's testing reports.

DETAILED SPECIFICATION  
FOR  
HMA PAVING, CITY OF ANN ARBOR

AA:MGN  
WT:VCM:CGT:AJK

5 of 5

02/07/14  
11/19/2022

All costs for furnishing and operating vacuum-type street cleaning equipment, backhoes, jackhammers, and air compressors shall be included in the bid prices for these items of work or in the item of work "General Conditions, Maximum, \$400,000".

All costs of meeting the requirements of this Detailed Specification shall be included in the bid prices for HMA items in the proposal and will not be paid for separately.

The completed work as measured for these items of work will be paid for at the Contract Unit Prices for the following Contract (Pay) Items:

<u>CONTRACT ITEM (PAY ITEM)</u>	<u>PAY UNIT</u>
Hand Patching, Modified .....	Ton
HMA, 3C .....	Ton
HMA, 4EML .....	Ton
HMA, 5EML .....	Ton

The unit prices for these items of work shall include all labor, material, and equipment costs to perform all the work specified in the Standard Specifications and as modified by this Detailed Specification.

CITY OF ANN ARBOR  
DETAILED SPECIFICATION  
FOR  
**PERMANENT TRAFFIC SIGNS AND SUPPORTS**

WT:CGT:VCM

1 of 2

11/11/2022

**a. Description**

This work consists of furnishing permanent traffic signs and supports in accordance with the Michigan Department of Transportation (MDOT) 2020 Standard Specifications for Construction, as shown on the plans, and as specified herein.

**b. Materials**

All materials required for the proposed signage as shown on the plans shall be delivered to the City of Ann Arbor Public Works, W.R. Wheeler Service Center, 4251 Stone School Road, Ann Arbor, MI 48108. The Contractor shall be responsible for all coordination with the City of Ann Arbor Signs and Signals Supervisor at 734.794.6361 for delivery. The contractor will not be entitled to extra compensation due to delays caused by City of Ann Arbor personnel.

The Contractor shall furnish materials in accordance with the following sections of the Michigan Department of Transportation Standard Specifications for Construction, except where otherwise noted below:

Anchor bolts, nuts, and washers – materials as specified in section 908

Band, Sign – materials as specified in sections 908 and 919

Sign, Type IIIA – materials as specified in section 919

Sign, Type IIIB – materials as specified in section 919

All materials for **Perforated Steel Square Tube Breakaway System, Modified** follow MDOT Standard Detail SIGN-207-A, and as noted below for the post, concrete base and anchor. The following materials shall be Unistrut or approved equal and shall include the following:

1. Post: exterior dimensions measure 2" x 2" square x 10', 14 gauge with 7/16" pre-punched holes, corner welded. Square tubing to allow for mounting on all four sides. Steel to conform to ASTM A1011 Grade 50, galvanizing to meet ASTM A-653. Must be able to mount signs with drive rivets to provide tamper resistance. Provide a smooth unbroken appearance for posts and anchors. Inline zinc coating to comply with AASHTO M-120 standard. Breakaway installation to meet FHWA approval standard.
2. Concrete Mount Base: interior dimensions measure 2" x 2" square x 6", 12 Gauge sleeve welded to 6"x6" square, 1/4" thick plate with four 3/4" holes. Centerpoint of each hole shall be 7/8" from each side of the plate. Edge of each hole shall be 1/2" from each side of plate.
3. Anchor: interior dimensions measure 2" x 2" square x 3', 12 Gauge sleeve

CITY OF ANN ARBOR  
 DETAILED SPECIFICATION  
 FOR  
**PERMANENT TRAFFIC SIGNS AND SUPPORTS**

WT:CGT:VCM

2 of 2

11/11/2022

All materials for **Pelco Sign-Brac, Galaxy Cable Mount, Formed Tube** for a mast arm sign install shall be exclusively procured and no substitutions shall be allowed. The following Pelco part numbers and specifications apply:

- Galaxy Cable Mount, Formed Tube Complete Kit
  - AG-0142
  - Sign CTC 15 inches
  - Provide 84-inch uncoated stainless-steel cable
- Astro-Bracket
  - AG-3055
  - 84-inch uncoated stainless-steel cable
  - 15 inch CTC
  - No color
- Sign Bracket
  - AB-0507
  - 15 inch CTC
  - No color

**c. Construction**

The City of Ann Arbor shall install permanent traffic signs and supports. The contractor will not be entitled to extra compensation due to delays caused by City of Ann Arbor personnel.

**d. Measurement and Payment**

Measure and pay for the completed work, as described, at the respective contract unit prices using the following pay item:

<u>Contract Item (Pay Item)</u>	<u>Unit</u>
Band, Sign .....	Each
Fdn, Perforated Steel Square Tube Breakaway System, Rem .....	Each
Sign, Type III, Rem.....	Each
Sign, Type IIIA, Modified .....	Square Foot
Sign, Type IIIB, Modified .....	Square Foot
Reflective Panel for Permanent Sign Support, 3 foot, Modified .....	Each
Perforated Steel Square Tube Breakaway System, Modified .....	Each

Payment for permanent traffic signs and supports includes all labor, material, and equipment required for furnishing and delivering the materials as shown on the plans and as specified herein.

Payment for bases, posts, and mounting hardware shall not be paid for separately but shall be included in the corresponding pay item(s).

DETAILED SPECIFICATION  
FOR  
**PARKING METERS AND PAY MACHINES**

AA:MGN  
AJK:

1 of 3

11/13/22

**a. Description**

This work shall consist of contacting and coordinating with PCI Municipal Services for the removal and replacement of parking meter pay machines along S. Main Street where called out on the plans or as directed by the Engineer and removal and replacement of parking meter standards. All work must be conducted in accordance with the MDOT 2020 Standard Specifications for Construction and the City Standard Specifications.

**b. Materials**

PCI Municipal Services will supply all standards. Standards are steel tubes 60 inches to 63 inches in length and 2 inches square.

All sand shall meet the gradation of MDOT Class II granular material in accordance with section 902 of the MDOT 2020 Standards Specifications for Construction.

Concrete shall be Grade 3500 in accordance with section 1004 of MDOT 2020 Standard Specification for Construction.

**c. Construction**

The Contractor shall not be permitted to remove meter heads nor standards with meter heads still attached.

In advance of all removal operations, the Contractor shall contact Kelly Kowalski, On-Street Operations Assistant Manager, PCI Municipal Services at 734 548-6216 to coordinate the removal of parking meter heads and pay machines identified and marked by the Engineer for removal.

The Contractor shall provide Kelly Kowalski with timely and substantial notice to allow such time that the meter heads and pay machines may be removed in advance of any construction activities to prevent conflict between work crews.

The Contractor shall remove, haul away, and dispose of parking meter standards and foundations and backfill the void with Class II granular material.

Where installing in existing sidewalk, the Contractor shall core an 8-inch diameter hole through the sidewalk at locations staked by the City. The Contractor shall be mindful of and exercise caution when coring above underground utilities.

Where installing standards in new sidewalk, the Contractor may install the standard at locations staked by the City in advance of sidewalk construction.

DETAILED SPECIFICATION  
FOR  
**PARKING METERS AND PAY MACHINES**

AA:MGN  
AJK:

2 of 3

11/13/22

The Contractor shall coordinate with the City for staking.

The City will stake locations approximately 18 inches to 24 inches from the curb line and 48 inches from the front end of a stall for parallel parking.

The Contractor shall excavate a hole 8 inches wide and 30 inches deep which tapers to 10 inches wide at the bottom.

The Contractor shall set the standards plumb and level in the excavated holes and then fill the holes with concrete. The standard shall be oriented such that the REAMED END is at the TOP and the WEEP HOLE on the LOWER END is FACING THE STREET. The meter standard is to project 37" above the sidewalk level.

The Contractor shall check that the standard is plumb with a surface level, first in one direction and then in the other and then hold the standard securely in position with bracing until the concrete has set.

After the standard has been set plumb, check the vertical alignment down the street and the height uniformity, making such corrections and adjustments as necessary.

The Contractor shall protect the standard until the concrete foundation has set. If the standard is found to not be plumb, the Contractor shall remove and reinstall the standard at the Contractor's expense.

The Contractor shall coordinate with Kelly Kowalski for the installation of the parking meter heads after new standards are installed and pay machines after paving the leveling course.

Installation of standards shall be considered part of substantial completion. The Contractor shall not be entitled to any compensation due to delays caused by City of Ann Arbor and/or PCI Municipal Services personnel.

**1. Parking Meter Head Covers** - The Contractor shall coordinate with PCI Municipal Services to have meter bags installed on the meter heads a minimum of 24-hours prior to the desired time of enforcement. The City will require written documentation from the Contractor that the meter bags are in place. The Parking Enforcement Office will be unable to enforce the desired "No-Parking Zone" unless the PCI Municipal Services installs the meter bags in a timely manner.

The Contractor has the sole responsibility for coordinating with PCI Municipal Services for the placement and maintenance of the meter bags, and delays due to unrestricted on-street parking shall not be cause for any claim for extra payments to the Contractor.

DETAILED SPECIFICATION  
FOR  
**PARKING METERS AND PAY MACHINES**

AA:MGN  
AJK:

3 of 3

11/13/22

Further information regarding the placement of meter bags and the temporary prohibition of on-street parking is available from PCI Municipal Services.

PCI Municipal Services will waive all meter bag rental fees for this project. The Contractor will be responsible for all costs associated with the placement of meter bags required by the project. Costs associated with placement of meter bags will not be paid for separately but shall be included in the bid price of the Contract Item “**General Conditions, Max \$\_\_\_\_\_**”.

**d. Measurement and Payment**

The work completed and measured for Parking Meters and Pay Machines shall be paid for at the contract unit price for the following pay items:

<u>Contract Item (Pay Item)</u>	<u>Unit</u>
Parking Meter, Rem.....	Each
Parking Meter, Install .....	Each

Payment for coordinating with Kelly Kowalski shall be included in payment for other pay items.

The removal, hauling away, and disposal of standards, foundations, excavated materials, and backfill shall not be paid separately, but shall be included in payment for Parking Meter, Rem.

Concrete and bracing furnished shall not be paid separately, but shall be included in payment for Parking Meter, Install.

The unit price for these items of work shall include all labor, material, and equipment costs to perform all the work.



DETAILED SPECIFICATION  
FOR  
**PERMANENT PAVEMENT MARKINGS**

WT:VCM/CEW

1 of 4

11/20/22

**DESCRIPTION**

This work consists of providing and placing permanent pavement markings in accordance with the Michigan Manual of Uniform Traffic Control Devices (MMTUTCD), latest version published at time of advertisement. Provide pavement markings that conform to the Plans, the Michigan Department of Transportation (MDOT) 2020 Standard Specifications for Construction, MDOT Pavement Marking Standard Plans, City of Ann Arbor Special Details, and as specified herein.

**MATERIALS**

Provide materials in accordance with section 811 and 920 of the MDOT 2020 Standard Specifications for Construction. Provide the Material Safety Data Sheets to the Engineer for required materials and supplies. Dispose of unused material and containers in accordance with the Federal Resource Conservation Recovery Act (RCRA) of 1976 as amended, and 1994 PA 451, Part 111 Hazardous Waste Management. Provide samples of permanent marking materials upon request.

**Preformed Thermoplastic** - Ensure the pavement is free of excess surface and subsurface moisture that may affect bonding. The Engineer will not decide the suitability of specific days for the application of preformed thermoplastic. Heat and apply the Preformed thermoplastic material as recommended by the manufacturer. Feather all edges of the material with a putty knife while the preformed thermoplastic is still soft.

Wet Night Retroreflective Beads and/or Elements. Select WR beads and/or elements from one of the following Manufacturers or a Department approved alternative that meets the requirements in Table 1:

- 3M Corporation
- Potter's Industries
- Swarco
- Flex-o-Lite

**Table 1: WR Markings**

Average Initial Retroreflectivity at 30 meter geometry in mcd/lux/m <sup>2</sup>		
Test Method	Color	
	White	Yellow
Dry (ASTM E 1710)	700	500
Wet Recovery (ASTM E 2177)	250	200

DETAILED SPECIFICATION  
FOR  
**PERMANENT PAVEMENT MARKINGS**

WT:VCM/CEW

2 of 4

11/20/22

Ship the material to the job site in sturdy containers marked in accordance with subsection 920.1.A of the Standard Specifications for Construction. Submit to the Engineer prior to the start of work:

- a. The Manufacturer's recommended application rate of the beads/elements and the liquid applied pavement marking binder to be used on the project. If the Manufacturer's recommended application rate differs from the specified rate in Table 811-1 of the Standard Specifications for Construction, the Manufacturer's recommended rate supersedes the table values.
- b. Certification from the Manufacturer that when applied according to their application recommendations the beads and/or elements meet the requirements shown in Table 1 above.

Binder. Provide a liquid pavement marking product of the binder type specified in the contract documents from section 811 of the Qualified Products List or as specified by special provision, or use an alternative binder as approved by the Engineer.

The Endurablend bike lane pavement marking material must be comprised with green pigment and anti-skid abilities. The polymer cement surfacing shall be manufactured by Pavement Surface Coatings of Hanover New Jersey, and no material substitutions will be allowed.

1. Pigmented Resin. Transpo Color-Safe Bike Lane Green must be used as the pigment or approved equal. The approved color pigmented resin shall comply with FHWA green color guidelines for bike lanes.
2. Anti-Skid Aggregate. Anti-skid aggregates shall be provided by the pavement marking supplier. Aggregate shall have a minimum Hardness of 7.0 per MohsScale

### **CONSTRUCTION METHODS**

The preparation and placement of permanent markings shall conform to section 811 of the MDOT 2020 Standard Specifications, the Plans, and as specified herein.

Place the binder and beads and polymer surface coatings in accordance with the Manufacturers' recommendations and sections 811 and 920 of the Standard Specifications for Construction except as noted above.

Construction of bike lane pavement markings shall be in accordance with

DETAILED SPECIFICATION  
FOR  
**PERMANENT PAVEMENT MARKINGS**

WT:VCM/CEW

3 of 4

11/20/22

manufacturer application and installation procedures, MDOT 2020 Standard Specifications for Construction, and Engineer.

All pavement marking areas shall be laid out by the contractor and then reviewed by the Engineer. Marking layout shall be approved by the Engineer prior to placement of material.

Surface preparation shall include cleaning of the pavement surface using high pressure water, compressed air or sandblasting and shall conform to ASTM D4263. All surface damage shall be corrected by the Contractor at the Contractor's expense, as directed by the Engineer. Manufacturer recommended pavement and air temperatures must be followed.

All markings on concrete surfaces shall receive a base coat application and shall be included in the pay item. Marking layout, material mixing, base coat application, and pigmented coat application shall comply with the manufacturer's installation procedures.

The Contractor shall protect the pavement markings from damage and allow them to fully cure prior to allowing traffic to drive over markings. Any damage shall be corrected by the Contractor at the Contractor's expense.

**MEASUREMENT AND PAYMENT**

Completed work, as described, will be measured and paid for at Contract Unit Prices for the following Contract (Pay) Items:

DS-139

**Contract Pay Item Pay Unit**

Rem Spec Mrkg .....	Square Feet
Pavt Mrkg, Polyurea, 4 inch, White.....	Foot
Pavt Mrkg, Polyurea, 4 inch, Yellow .....	Foot
Pavt Mrkg, Polyurea, 18 inch, White.....	Foot
Pavt Mrkg, Polyurea, 12 inch, Crosswalk .....	Foot
Pavt Mrkg, Polyurea, 24 inch, Stop Bar.....	Foot
Pavt Mrkg, Polyurea, Sharrow Sym.....	Each
Pavt Mrkg, Polyurea, Lt Turn Arrow Sym .....	Each
Scarification, for Polyurea Spec Mrkg.....	Square Feet

DETAILED SPECIFICATION  
FOR  
**PERMANENT PAVEMENT MARKINGS**

WT:VCM/CEW

4 of 4

11/20/22

Pavt Mrkg, Polyurea, 12 inch, Cross Hatching, Yellow .....	Foot
Pavt Mrkg, Polyurea, Bike, Lt Turn Arrow Sym .....	Each
Pavt Mrkg, Polyurea, Bike, Rt Turn Arrow Sym .....	Each
Pavt Mrkg, Bike Lane, Green .....	Square Feet

The unit prices for these items of work shall include all labor, material, and equipment costs to perform all the work specified in the MDOT 2020 Standard Specifications for Construction and as modified by this Detailed Specification.

DETAILED SPECIFICATION  
FOR  
**RECESSED PAVEMENT MARKINGS**

WT:AJK

1 of 2

11/9/2022

**Description**

This work consists of providing all equipment and labor required to prepare (grooving) the pavement surface for recessed longitudinal, transverse, and turning guideline pavement markings in accordance with the City of Ann Arbor Permanent Pavement Markings Detailed Specification, the plans, and this detailed specification.

**a. Materials**

None specified.

**b. Construction**

Install a recess (groove) in accordance with the recessed pavement marking material manufacturer's installation instructions. Ensure all recessing configurations are in accordance with the Michigan Manual of Uniform Traffic Control Devices and the Michigan Department of Transportation Pavement Marking Standards.

1. Grooving Concrete and Hot Mix Asphalt Pavement. If there are no markings on the pavement, paint a temporary tracer line (with no beads) exactly where the permanent markings will be placed. Use these lines as a template for the grooving operation.

Use equipment and methods approved by the manufacturer of the recessed pavement marking material to be recessed for forming grooves in pavement surfaces. Dry cut the grooves in a single pass using stacked diamond cutting heads on self-vacuuming equipment capable of producing a finished groove ready for pavement marking material installation.

Ensure that the bottom of the groove has a fine corduroy finish. If a coarse tooth pattern results, increase the number of blades and decrease the spaces on the cutting head until the required finish is achieved.

2. Groove Dimensions. Ensure grooves for recessed pavement markings are in accordance with the following:

Longitudinal Markings

Groove Width: Material width +1 inch, ( $\pm 1/8$  inch)  
Groove Depth: As recommended by the manufacturer, ( $\pm 5$  mils)  
Groove Position: Center/Lane Lines: 2 inches from joint line, ( $\pm 1/8$  inch)

DETAILED SPECIFICATION  
FOR  
**RECESSED PAVEMENT MARKINGS**

WT:AJK

2 of 2

11/9/2022

Edge Lines: On lane, 2-4 inches in from the joint line, ( $\pm 1/8$  inch) Edge Lines for 14-foot paved lanes: as directed by the Engineer

Transverse Markings

Groove Width: Material width +1 inch, ( $\pm 1/8$  inch)  
Groove Depth: As recommended by the manufacturer, ( $\pm 5$  mils)

Groove Position: In the exact location where the transverse marking (crosswalk or stop bar) will be placed.

Turning Guideline Markings

Groove Width: Material width +1 inch, ( $\pm 1/8$  inch)  
Groove Depth: As recommended by the manufacturer, ( $\pm 5$  mils)  
Groove Position: In the exact location where the turning guideline markings will be placed.

Placing Recessed Pavement Markings. Place the pavement marking material in the grooves within 24 hours of the grooves being made. Ensure the grooves are clean and dry prior to placing pavement marking material. Locate the groove so the entire marking can be placed within the groove.

**c. Measurement and payment**

The completed work, as described, will be measured, and paid for at the contract unit price using the following pay items:

<u>PAY ITEM</u>	<u>PAY UNIT</u>
Recess Pavt Mrkg, Longit.....	Linear Foot
Recess Pavt Mrkg, Spec Mrkg .....	Square Foot

Pavement marking materials, including retroreflective pavement marking required for traffic control, will be paid for separately using the appropriate pay items.

DETAILED SPECIFICATION  
FOR  
**TEMPORARY PEDESTRIAN PATH**

WT:VCM/CEW

1 of 2

11/20/22

**a. Description.** This work consists of furnishing, installing, maintaining, and removing a temporary pedestrian path as identified in the proposal or on the plans. Temporary pedestrian paths, or segments thereof, will be repaired or replaced as directed by the Engineer.

**b. Materials.** Provide materials to construct a temporary pedestrian path in accordance with the contract, the *Public Right of Way Accessibility Guidelines (PROWAG)*, the *MMUTCD*, as directed by the Engineer, and the following requirements:

1. Ensure the materials used to construct the temporary pedestrian path yields a continuous hard surface that is firm, stable and skid resistant. Ensure the path does not warp, buckle or otherwise become uneven, and materials support the weight of pedestrians as well as motorized scooters and wheelchairs. Suitable materials to construct the path include asphalt materials, Oriented Strand Board (OSB), plywood, dimensional lumber, reclaimed, or other as approved by the Engineer. Compacted soils, aggregate and sand are prohibited.

2. If asphalt materials are not used to construct the path, provide an antiskid coating, or surface treatment as directed by the Engineer.

**c. Construction.** Construct the temporary pedestrian path in accordance with *PROWAG*, the *MMUTCD*, the contract, the direction of the Engineer, and the following:

1. The useable surface of the path must be a minimum of 48 inches wide, additional width may be provided to preclude the use of Temporary Pedestrian Passing Spaces (paid for separately). A minimum width of 60 inches is required if Temporary Pedestrian Passing Spaces are not provided as part of the temporary facility. The maximum cross slope for the path is 2 percent. The path, including transitions to the adjacent surface at both ends, must be free of vertical discontinuities greater than 1/4 inch. Eliminate any vertical discontinuities greater than 1/4 inch up to 1/2 inch or bevel with a slope not steeper than 1:2. If a vertical discontinuity greater than 1/2 inch or a running slope greater than 1:20 occurs on the project, a Temporary Pedestrian Ramp (paid for separately) is required.

A. Ensure an anti-skid surface treatment is applied to the surface of the path, if not constructed with asphalt materials, as directed by the Engineer.

B. If the surface of the path is constructed from OSB, plywood, or dimensional lumber securely connect all sections with appropriate fasteners to ensure a continuous, uniform and flat surface.

2. Ensure all debris and construction materials is cleared from the path throughout its use. Ensure snow and ice is removed; the use of an approved de-icing agent may be required.

3. Repair or replace the path, or segments thereof, if it becomes uneven, unstable, or displaces due to weather events, construction activities, or other causes as directed by the Engineer.

4. Following the use of the temporary path, the Contractor must remove and dispose all materials used to construct the path, and restore the area as directed by the Engineer.

**d. Measurement and Payment.** The completed work, as described, will be measured and paid for at the contract unit price using the following pay item:

<b>Pay Item</b>	<b>Pay Unit</b>
Pedestrian Path, Temp .....	Foot

**Pedestrian Path, Temp** will be measured along the centerline of the path. **Pedestrian Path, Temp** includes all costs related to installation, maintenance, restoration, and removal of the path and disposal of all associated materials throughout the life of the contract.



DETAILED SPECIFICATION  
FOR  
**TEMPORARY PEDESTRIAN RAMP**

WT:VCM

1 of 3

11/20/22

**a. Description.** This work consists of furnishing, installing, maintaining, relocating, and removing a temporary pedestrian ramp as identified in the proposal or on the plans. Use temporary pedestrian ramps to facilitate pedestrian travel on accessible facilities over curbs or other uneven terrain features with a vertical difference of 1/2 inch or greater. Damaged pedestrian ramps will be replaced as directed by the Engineer.

**b. Materials.** Provide materials to construct a temporary pedestrian ramp in accordance with the *Americans with Disabilities Act (ADA)*, the standard specifications, and the following:

1. Ensure the material used to construct the temporary pedestrian ramp is firm, stable, skid resistant, and forms a continuous hard surface. Ensure the surface does not warp, buckle or otherwise become uneven, and materials support the weight of pedestrians as well as motorized scooters and wheelchairs. Suitable materials to construct the surface of the ramp include asphalt materials, Oriented Strand Board (OSB) or plywood, dimensional lumber, certain reclaimed or other materials as approved by the Engineer. Compacted soils, aggregate and sand are prohibited.

2. Provide a handrail on both sides of the ramp if the ramp is not exposed to vehicle traffic and has a total rise greater than 6 inches, and a length greater than 72 inches. Ensure the handrail is between 1.25 and 1.5 inches wide and configured to be a “graspable” cross-section. See construction subsection 2.A for additional details. When the ramp is exposed to traffic, in lieu of handrails, use a protective edge 2.5 inches minimum height above the ramp surface or 1:10 flare on both sides of the ramp.

3. Ensure the surface of the ramp is free draining; in addition, provide features that allow drainage to move past the ramp installation (i.e. along the gutter pan underneath the ramp if the ramp is installed on a curb).

4. Provide materials to construct detectable edging along open sides of the ramp if required.

5. If asphalt materials are not used to construct the surface of the ramp, provide an antiskid coating or surface treatment approved by the Engineer.

**c. Construction.** Construct the temporary pedestrian ramp in accordance with the manufacturer’s recommendations (if applicable), *ADA*, the plans, and the following:

1. Ensure the useable surface of the ramp is 48 inches wide and does not deflect due to pedestrian traffic. Ensure an anti-skid surface treatment is applied to the useable area of the ramp if it is not made from asphalt materials. The maximum cross

slope of the ramp is 2 percent. Ensure both ends of the ramp smoothly transitions to the adjacent surface, with 1/4 inch or less vertical difference.

Construct the ramp to maintain a longitudinal slope from 1:10 to 1:12 where possible. Otherwise, a longitudinal slope from 1:8 to 1:10 may be used for a maximum rise of 3 inches. Temporary pedestrian ramps with longitudinal slopes greater than 1:8 are prohibited.

A. Provide a handrail on both sides of the ramp if required as stated herein. Ensure the top of the handrail is between 34 and 38 inches above the surface of the ramp. Ensure a minimum width of 36 inches is maintained between the handrails, with a minimum clearance of 1.5 inches behind and 18 inches above.

Construct the handrail such that the bending stress applied by a bending moment created by a 250 pound force is less than the allowable stress for the materials and the construction of the handrail. Construct the handrail to withstand the shear stress induced by a 250 pound force. Ensure all fasteners, mounting devices and support structures are also able to withstand shear stress induced by a 250 pound force.

2. Construct a detectable edging anytime a handrail is required, and anytime the path changes direction. This includes a turn onto the ramp from the path. Detectable edging must begin a maximum of 2.5 inches above the ramp surface, and extend at least 6 inches above the ramp surface.

3. Ensure a clear space (minimum 48 inches by 48 inches) is provided above and below the ramp.

4. Avoid locating ramps in areas of drainage collection, ponding or running water, which can produce slippery or unsafe conditions. If the ramp is located over a gutter pan or other drainage structure, provide features to facilitate water movement around or under the ramp as approved by the Engineer.

5. Ensure all debris and construction material is cleared from the surface of the ramp throughout its use. Ensure snow and ice is removed; the use of an approved de-icing agent may be required. Repair or replace the ramp if it becomes uneven, unstable, or displaces due to weather events, construction activities, or other causes as directed by the Engineer.

**d. Measurement and Payment.** The completed work, as described, will be measured and paid for at the contract unit price using the following pay item:

<b>Pay Item</b>	<b>Pay Unit</b>
Pedestrian Ramp, Temp.....	Each

**Pedestrian Ramp, Temp** includes all labor, equipment, and materials to furnish, install and remove a temporary pedestrian ramp at the locations shown on the plans, as well as all costs for maintaining, clearing debris, deicing, reconfiguring, and relocating the temporary pedestrian ramp throughout the life of the contract.

DETAILED SPECIFICATION  
FOR  
**TEMPORARY PEDESTRIAN TYPE II BARRICADE**

WT:VCM

1 of 2

11/20/22

**a. Description.** This work consists of furnishing, installing, maintaining, relocating, and removing a temporary pedestrian Type II barricade section as identified in the proposal or on the plans. Use temporary pedestrian Type II barricades to close non-motorized facilities including sidewalks, bicycle paths, pedestrian paths, and shared use paths that are not part of the roadway. One pedestrian Type II barricade is defined as a barricade section at least 43 inches wide, including all supports, ballast, and hardware.

**b. Materials.** Provide a temporary pedestrian Type II barricade that meets the requirements of *National Cooperative Highway Research Program Report 350 (NCHRP 350)* or *Manual for Assessing Safety Hardware (MASH)*, in addition to meeting the following requirements:

1. Provide barricade sections at least 43 inches wide, designed to interconnect to ensure a continuous *Americans with Disabilities Act (ADA)* compliant tactile barrier. Ensure the connection includes provisions to accommodate non-linear alignment as well as variations in elevation at the installation area.

2. Ensure the top surface of the barricade is designed to function as a hand-trailing edge, and has a height between 32 and 38 inches. Ensure the lower edge of the barricade is no more than 2 inches above the surface of the non-motorized facility. Ensure the top edge of the bottom rail of the barricade is a minimum of 8 inches above the surface of the non-motorized facility. The barricade may have a solid continuous face. Finally, all features on the front face of the barricade (the face in contact with pedestrians) must share a common vertical plane.

3. Equip both sides of the barricade with bands of alternating 6-inch wide orange and white vertical stripes of reflective sheeting. Two bands of sheeting 6 inches tall and a minimum of 36 inches long containing at least two orange and two white stripes each are required. One band placed near the top and one near the bottom if the barricade section has a solid face. If the barricade consists of two rails, affix one band of sheeting to each rail. Ensure the stripes of reflective sheeting are aligned vertically. Ensure this sheeting meets or exceeds the requirements of *ASTM D 4956* Type IV sheeting.

**c. Construction.** Construct the temporary pedestrian Type II barricade in accordance with the manufacturer's recommendations, Michigan Manual on Uniform Traffic Control Devices (MMUTCD), the plans, and the following requirements:

1. Install the barricade as shown on the plans and as directed by the Engineer. Interconnect all barricade sections using hinge components if necessary to ensure a continuous detectable edge for the entire installation. Ensure the barricade is

ballasted according to the manufacturer’s recommendations to ensure stability during wind events and contact with pedestrians.

2. When the barricade is installed near motor vehicle traffic, ensure reflective sheeting is visible to motorists.

3. When pedestrian Type II barricades are used to close a non-motorized facility, ensure a sufficient number of barricade sections are used to block the entire width of the facility. The barricade may extend outside the edge of the non-motorized facility but must not be less than the full width of the facility.

4. If sections of multiple colored barriers are used (i.e. safety orange and white) install the sections such that the colors alternate to increase conspicuity.

5. Ensure pedestrian Type II barricades are not used to close a motor vehicle facility. Ensure these barricades are not used to guide pedestrian traffic on a motor vehicle facility in the presence of active traffic. This prohibition includes bicycle/shared use lanes or shoulders in the presence of active traffic.

**d. Measurement and Payment.** The completed work, as described, will be measured and paid for at the contract unit price using the following pay item:

<b>Pay Item</b>	<b>Pay Unit</b>
Pedestrian Type II Barricade, Temp .....	Each

**Pedestrian Type II Barricade, Temp**, includes all labor, equipment, and materials to furnish, install, maintain, relocate, and remove one barricade section that is at least 43 inches wide. Additional payment will not be made if wider sections are provided. This includes all rails, supports, ballast, hinge points, reflective sheeting, and miscellaneous hardware needed to install and maintain a barricade section.

DETAILED SPECIFICATION  
FOR  
**TEMPORARY PEDESTRIAN TYPE II CHANNELIZER**

WT:VCM

1 of 2

11/20/22

**a. Description.** This work consists of furnishing, installing, maintaining, relocating, and removing temporary pedestrian channelizers as identified in the proposal or on the plans. Use temporary pedestrian channelizers to guide pedestrians along a temporary non-motorized facility, and to create separation of pedestrians from construction areas near existing facilities. Replace damaged temporary pedestrian Type II channelizers as directed by the Engineer.

**b. Materials.** Provide a temporary pedestrian channelizer that is crashworthy according to the *National Cooperative Highway Research Program Report 350* (NCHRP 350) or *Manual for Assessing Safety Hardware* (MASH), in addition to meeting the following requirements:

1. Ensure the channelizer is designed to interconnect to maintain continuous delineation along the entire installation. This includes provisions to accommodate non-linear alignment as well as variations in elevation.

2. Ensure the top surface of the channelizer is designed to function as a hand-trailing edge, and have a height between 32 and 38 inches. Ensure this top surface is designed to have a 2 inch horizontal gap between the top edge and the support (if so equipped), to allow for continuous hand-trailing without obstructions. Ensure the lower edge of the channelizer is no more than 2 inches above the surface of the non-motorized facility. Ensure the top edge of the bottom rail of the channelizer is a minimum of 8 inches above the surface of the non-motorized facility or the channelizer may have a solid continuous face. Finally, all features on the front face of the channelizers (the face in contact with pedestrians) must share a common vertical plane.

3. Equip both sides of the channelizer with bands of alternating 6-inch wide orange and white vertical stripes of reflective sheeting. Two bands of sheeting 6 inches tall and a minimum of 36 inches long containing at least two orange and two white stripes each are required. One band placed near the top and one near the bottom if the channelizer section has a solid face. If the channelizer consists of two rails, affix one band of sheeting to each rail. Ensure the stripes of reflective sheeting are aligned vertically. Ensure this sheeting meets or exceeds the requirements of *ASTM D 4956* Type IV sheeting.

**c. Construction.** Deploy the temporary pedestrian Type II channelizer in accordance with the manufacturer's recommendations, the Michigan Manual on Uniform Traffic Control Devices (MMUTCD), the plans, and the following requirements:

1. Install the channelizer as shown on the plans and as directed by the Engineer. Interconnect all channelizers using hinge components if necessary to ensure a

continuous detectable edge for the entire installation. Ensure the channelizers are ballasted according to the manufacturer’s recommendations to ensure stability during wind events and contact with pedestrians.

2. When the channelizers are installed near motor vehicle traffic, ensure reflective sheeting is visible to motorists providing appropriate delineation for the pedestrian path.

3. If sections of multiple colored barriers are used (i.e safety orange and white), install the sections such that the colors alternate to increase conspicuity.

4. Ensure temporary pedestrian Type II channelizers are not used to guide pedestrian traffic on a motor vehicle facility in the presence of active traffic. This prohibition includes bicycle/shared use lanes or shoulders in the presence of active traffic. Ensure temporary pedestrian channelizers are not used to channelize motor vehicle traffic, or separate motor vehicle and pedestrian traffic.

**d. Measurement and Payment.** The completed work, as described, will be measured and paid for at the contract unit price using the following pay item:

<b>Pay Item</b>	<b>Pay Unit</b>
Pedestrian Type II Channelizer, Temp .....	Foot

**Pedestrian Type II Channelizer, Temp** includes all labor, equipment, and materials to furnish, install, maintain, relocate and remove rails or wall sections, supports, ballast, and hinge points at the locations shown on the plans. This includes all rails or wall sections, supports, ballast, hinge points, and miscellaneous hardware needed to construct the channelizer or system of channelizers.

DETAILED SPECIFICATION  
FOR  
**MAINTAINING TRAFFIC AND SEQUENCE OF CONSTRUCTION**

WT:CEW:VCM:CGT	1 of 9	11/19/22
----------------	--------	----------

**a. Description.-**

Traffic shall be maintained in accordance with the City of Ann Arbor Public Services Department Standard Specifications and as specified in Sections 104.11, 812, and 922 of the Michigan Department of Transportation (MDOT) 2020 Standard Specifications for Construction, the 2011 Michigan Manual of Uniform Traffic Control Devices (MMUTCD), and as described herein.

The following, and herein included Michigan Department of Transportation (MDOT) Maintaining Traffic Typical and Work Zone Device Details apply to the project: 101-GEN-SPACING-CHARTS, 102-GEN-NOTES, 110TR-NFW-2L, WZD-100-A, and WZD-125-E.

These maintaining traffic provisions are subject to change in the event of special community activities.

The Contractor shall furnish, erect, maintain and, upon completion of the work, remove all traffic control devices and barricade lights as required on the project for the safety and protection of local traffic. This includes, but is not limited to, temporary advance, regulatory, and warning signs; barricades and channelizing devices at intersections and on streets where traffic is to be maintained; barricades at the ends of the project and at right-of-way lines of intersecting streets, and traffic control devices for moving construction operations.

**B. Materials.-**

The materials and equipment shall meet the requirements specified in the corresponding sections of the MDOT 2020 Standard Specifications for Construction and the 2011 MMUTCD.

All signs shall be of sizes shown on the plans, unless otherwise directed by the Engineer. Install temporary signs that are to remain in the same place for 14 days or more on driven posts. Install all other temporary signs on portable supports. All signs shall have a minimum bottom height of 7.0 feet.

Channelizing devices required for all lane closures shall be plastic drums. 42 inch channelizing devices are permissible with approval from the Engineer.

Cold Patching Material shall meet the requirements of the City of Ann Arbor Standard Specifications for Construction and as approved by the Engineer.



DETAILED SPECIFICATION  
FOR  
**MAINTAINING TRAFFIC AND SEQUENCE OF CONSTRUCTION**

WT:CEW:VCM:CGT

2 of 9

11/19/22

**MAINTENANCE OF LOCAL TRAFFIC**

Unless otherwise indicated on the plans, all side roads shall not be closed to through traffic except during construction operations of short duration and only upon written approval of the Engineer.

Local access shall be maintained at all times for emergency vehicles, refuse pick-up, mail delivery, business deliveries if vehicles are unable to access businesses from rear, and ingress/egress to public and private properties.

Contractor must accommodate the safe access to the residential buildings and businesses located within construction area. Pedestrian access to all buildings must be maintained throughout the construction period. An ADA compliant width of sidewalk shall be maintained along S Main Street throughout the duration of the project, with continuous pedestrian barricades between the pedestrian path and work zone. When it is necessary to close a section of sidewalk for a short period of time, temporary pedestrian ramps and pathways shall be implemented to maintain continuous and safe pedestrian access along the corridor. Pedestrian ramp crossings at intersections shall always be maintained at three of four corners. Only one corner of an intersection can be closed at a time. All pedestrian access shall be ADA compliant. For work affecting pedestrian crossings, use the included staging sheets and typical details to maintain pedestrian traffic.

Pedestrian building entrances or driveways shall not be blocked for extended periods of time unless arrangements can be made with the affected property owner(s). When it becomes necessary to temporarily block building entrances, the Contractor shall notify the Engineer seventy-two (72) hours in advance of any work planned on or near business entrances, and stage work so that it is part-width when it is necessary to work in these areas. The Engineer will not allow the Contractor to prohibit access to businesses or residences during any phase of construction, unless agreed upon with the property owner(s).

If the work involves closing a bicycle lane, BICYCLE (sym) W11-1 and SHARE THE ROAD W16-1P will be used to direct bicycle traffic into the vehicular lane.

At times, when it becomes necessary to temporarily obstruct local traffic during the performance of the work, the Contractor shall provide traffic regulator control in conformance with Chapter 6E of the MMUTCD, Sections 6E.01 thru 6E.08. A minimum of two traffic regulators are required. The cost of traffic regulator control shall be included in the Contract pay item "Minor Traffic Devices, Max \$160,000".

DETAILED SPECIFICATION  
FOR  
**MAINTAINING TRAFFIC AND SEQUENCE OF CONSTRUCTION**

WT:CEW:VCM:CGT	3 of 9	11/19/22
----------------	--------	----------

A lane-closure permit shall be obtained by the Contractor from the Engineering Unit, at least 48 hours in advance of any proposed lane or street closing. No lane closures shall be permitted during the following weekends, unless approved by the engineer:

- Memorial Day (3:00 PM Friday May 26, 2023 – 7:00 AM Tuesday, May 30, 2023)
- Independence Day (3:00 PM Friday June 30, 2023 – 7:00 AM Wednesday, July 5, 2023)
- Labor Day (3:00 PM Friday September 1, 2023 – 7:00 AM Tuesday, September 4, 2023)
- If the project is delayed, no work or lane closures, shall be performed during University of Michigan football games.

All streets and sidewalks that can be open shall be open to motorized and non-motorized traffic. The Engineer will also not permit any trucking on or off site during these times.

During non-working periods, any area with uncompleted work shall have plastic drums at specific locations and protective fencing, as directed by the Engineer, and at no additional cost to the project.

The hours of work on all Local streets are 7:00 a.m. to 8:00 p.m., Monday through Saturday, or as specified on the lane-closure permit. No equipment will be allowed in the street before or after these hours. Local streets may only be closed to through traffic (local access only) with written authorization of the Engineer. Work must be completed each day such that all streets are re-opened to through traffic by 8:00 p.m. unless otherwise specified, directed, or authorized in writing by the Engineer. All major changes in traffic control shall be made either between 9:30 a.m. and 3:30 p.m. or between 7:00 p.m. and 6:30 a.m. in order to minimize interference with rush-hour traffic. All traffic controls must be in-place and ready for traffic each day by 6:30 a.m. and 3:30 p.m.

The Contractor shall temporarily cover conflicting traffic and/or parking signs when directed by the Engineer included in the pay item “Minor Traffic Devices, Max \$160,000”.

The Contractor shall use quantities of dust palliative, maintenance aggregate, and cold patching/HMA mixtures for use as temporary base, surfacing, and dust control at utility crossings, side roads and driveways (wherever required to maintain traffic), and where directed by the Engineer to maintain local access. The cost for the use of dust palliative, maintenance aggregate, cold patch and/or hot mix asphalt 36A mixture, as required and directed by the Engineer for maintenance of traffic and local access, shall be included in Contract pay item “General Conditions, Max \$400,000”, and it will not be paid for separately.

The work of maintaining and relocating existing warning, regulatory and/or guide signs; and of removing, salvaging and reinstalling existing signs and supports is included in the bid price for the Contract pay item “Minor Traffic Devices, Max \$160,000”.

DETAILED SPECIFICATION  
FOR  
**MAINTAINING TRAFFIC AND SEQUENCE OF CONSTRUCTION**

WT:CEW:VCM:CGT

4 of 9

11/19/22

Mailboxes and newspaper boxes that are in the way of the construction shall be removed and reset immediately in a temporary location per the detailed specification "Mailbox, Temporary Relocate" and as approved by the Engineer. Mail and paper delivery shall not be interrupted during the construction. Upon completion of the construction, all mailboxes and newspaper boxes, including their supports, shall be repositioned in their permanent locations as approved by the Engineer. This work shall be included the Contract unit price for the Contract pay item "General Conditions, Max \$400,000", and it will not be paid for separately.

The Contractor shall perform the work of this Contract while maintaining traffic in accordance with the Contract Documents as specified herein. No traffic shall be allowed on newly placed asphalt surfaces until rolling has been satisfactorily completed and the surface has cooled sufficiently to prevent damage from traffic. This is to be accomplished by traffic regulators and by relocating traffic control devices to prevent traffic from entering the work area until such time that it can be safely maintained without damaging the new construction. The Contractor shall provide traffic regulators in sufficient number to maintain traffic as described herein, and to keep traffic off sections being surfaced, and provide for safe travel at all times as directed by the Engineer.

Each pressure distributor, paver and roller shall be equipped with at least one approved flasher light which shall be mounted on the equipment so as to give a warning signal ahead and behind.

The paving of the top course shall be conducted under traffic by utilizing traffic regulators (flag persons), channelizing devices and signs in accordance with Part VI of the current edition of the Michigan Manual of Uniform Traffic Control devices (MMUTCD) as amended. The installation and removal of minor traffic control devices needed for the maintenance of traffic during the paving of final wearing course and the furnishing of traffic regulators shall be paid as "Minor Traffic Devices, Max \$160,000" and "Traffic Regulator Control" as appropriate.

The Contractor shall furnish, erect, maintain, and upon completion of the work, remove any and all traffic control devices utilized on the project.

**Construction Influence Area (CIA).**- The CIA shall include the area from POB to POE within the Right-of-way of S Main Street and partially along William, Liberty, Washington and Huron as shown in the plans. The CIA shall include the affected portions of the driveways along and contiguous with these roadways.

In addition, the CIA shall include the rights-of-way of all roadway segments used for detours and all locations that contain advance warning and/or regulatory signs, pavement

DETAILED SPECIFICATION  
FOR  
**MAINTAINING TRAFFIC AND SEQUENCE OF CONSTRUCTION**

WT:CEW:VCM:CGT

5 of 9

11/19/22

markings, plastic drums, traffic delineators, and all other project related traffic maintenance items.

Police and Fire.- The Contractor shall notify local police, fire departments and emergency response units a minimum of three business days (72 hours) prior to the closure of any roads, or traffic shifts causing restricted movements of traffic or restricted access.

Work Performed by City of Ann Arbor Signs and Signals Unit.- **No additional or extra compensation will be paid for any delays caused by City of Ann Arbor Signs and Signals.**

Signal Modifications

Signal timing and phasing modifications are not anticipated for construction at this time. This shall be evaluated and if the need arises, the Contractor shall coordinate work with the City ahead of any decided changes in the traffic control.

Sign Reinstallation

As necessary during construction, the Contractor shall be responsible for logging the legend and location of any signs that:

1. Must be removed to facilitate the construction process;
2. Are to be permanently removed, or;
3. Are to be permanently relocated.

The Contractor shall remove the signs as indicated on the plans. The Contractor will have all proposed signs, posts, and associated mounting materials delivered to the City of Ann Arbor Public Works, W.R. Wheeler Service Center, 4251 Stone School Road, Ann Arbor, MI. After construction is complete, but before opening any roadway to traffic, City of Ann Arbor Signs and Signals will install all signs in their proper, permanent location. To coordinate sign installation/reinstallation, the Contractor shall notify the Signs and Signals Unit at least five (5) working days (Monday-Friday) in advance of when the sign work will need to be completed. It is the responsibility of the Contractor to ensure that City of Ann Arbor Signs and Signals Unit is scheduled, kept apprised of the progress of construction, and notified a second time immediately (4 working hours) prior to the need to complete the sign work. The installation/reinstallation of all signs shall be completed by the City of Ann Arbor Signs and Signals Unit.

**PROJECT SCHEDULE MILESTONES:**

In general, the project will proceed in three Phases. The project takes place within a heavy merchant and pedestrian environment. The Contractor is required to work with the City of Ann Arbor to minimize merchant disruptions as much as possible.

DETAILED SPECIFICATION  
FOR  
**MAINTAINING TRAFFIC AND SEQUENCE OF CONSTRUCTION**

WT:CEW:VCM:CGT	6 of 9	11/19/22
----------------	--------	----------

**Phase 1 Work** – All Phase 1 work in S Main St from William to Liberty and within the William/Main and Liberty/Main intersections shall be completed as shown on the overall phasing plan. This includes the installation of watermain, storm sewer, paving, restoration, signal work, pavement markings, signage and anything else included in the Contract for this block. During this phase, the watermain shall be completed, tested and connected to the existing watermain at William, east and west on Liberty, and at the temporary connection just north of Liberty. Note that the Engineer may request watermain shut downs to occur during non-standard hours in order to minimize interruption to businesses. All Phase 1 services shall be installed and connected during this phase. Existing watermain within Phase 1 limits shall be abandoned once the proposed Phase 1 watermain is live.

Phase 1 shall be completed in its entirety and open to traffic by **May 5, 2023**. All Phase 1 work shall be completed prior to the beginning of Phase 2 work.

**Phase 1A Maintenance of Traffic** – South Main Street, from north of William thru Liberty will be closed to thru traffic in both directions and the Liberty/Main intersection will be closed to eastbound and westbound traffic. Access for emergency traffic will be maintained at all times.

**Phase 1B Maintenance of Traffic** – South Main Street from William thru Liberty will be closed to thru traffic in both directions, the Liberty/Main intersection will be closed to eastbound and westbound traffic, and William Street will be closed to westbound traffic. Access for emergency traffic will be maintained at all times. This phase will be used for the connection to the existing watermain in William Street, and all restoration required on the north side of the William Street intersection.

**Phase 1C Maintenance of Traffic** - South Main Street from William thru Liberty will be closed to thru traffic in both directions, the Liberty/Main intersection will be closed to eastbound and westbound traffic, and William Street will be closed to eastbound traffic. Access for emergency traffic will be maintained at all times. This phase will be used for all proposed work on the south side of the William Street intersection.

**Note: Phase 1B and 1C shall not occur at the same time.**

**Phase 2 Work** –All Phase 2 work in S Main St from north of Liberty to south of Huron and within the Washington/Main intersection shall be completed as shown on the overall phasing plan. This includes the installation of watermain, storm sewer, paving, restoration, signal work, pavement markings, signage and anything else included in the Contract for these two blocks (except for sidewalk, curb and pavement work on the southeast and southwest quadrants of Huron/Main intersection). During this phase, the

DETAILED SPECIFICATION  
FOR  
**MAINTAINING TRAFFIC AND SEQUENCE OF CONSTRUCTION**

WT:CEW:VCM:CGT	7 of 9	11/19/22
----------------	--------	----------

watermain shall be completed, tested and connected to the existing watermain east and west on Washington and just south of Huron (connection just south of Huron shall be completed in such a way to limit disturbance to the surface at the Huron/Main intersection). The temporary Phase 1 watermain connection shall be removed and the Phase 2 watermain shall be connected to the Phase 1 watermain. Note that the Engineer may request watermain shut downs to occur during non-standard hours in order to minimize interruption to businesses. All Phase 2 services shall be installed and connected during this phase. Existing watermain within Phase 2 limits shall be abandoned once the proposed Phase 2 watermain is live. Phase 2 shall be completed in its entirety and open to traffic by **July 12, 2023**. All Phase 2 work shall be completed prior to the beginning of Phase 3 work.

Phase 2 Maintenance of Traffic - South Main Street from north of Liberty to south of Huron will be closed to thru traffic in both directions, and the Washington/Main intersection will be closed to eastbound and westbound traffic. This phase will be used for all proposed work between Liberty and Huron.

**Ann Arbor Art Fair (July 17 2023 – July 22, 2023)** - No work is allowed within the Art Fair limits and shuttle routes between the Monday prior to Art Fair and the Monday following it (July 17, 2023 – July 24, 2023). This project falls within the limits of the Ann Arbor Art Fair. Phases 1 and 2 shall be completed, and the site shall be left in a clean and orderly condition and all equipment and stored material shall be relocated off-site. In the event that the milestones above are delayed and the Phase 2 work has not been completed by July 12, 2023, the Contractor will be responsible for cleaning, securing and providing temporary use of the area for the Art Fair from July 17, 2023 – July 24, 2023. Prior to work stoppage all businesses shall have pedestrian access in place, all equipment and stored materials will be relocated off site, all street surfaces shall have a temporary surface, and all unnecessary barricades removed. The site will be left in a clean, safe and orderly condition. If the milestones are delayed, temporary pavement and provisions needed to ensure the site meets conditions listed above will be at the sole cost of the Contractor.

**Phase 3 Work** – All Phase 3 work in S Main St at the Huron/Main intersection shall not begin until after the Ann Arbor Art Fair unless otherwise approved by the Engineer. All Phase 3 work shall be completed

as shown in the overall phasing plan. This includes the installation of storm sewer, paving, restoration, pavement markings, signage and anything else included in the Contract for this intersection. Phase 3 shall be completed in its entirety and open to traffic by **August 25, 2023**.

DETAILED SPECIFICATION  
FOR  
**MAINTAINING TRAFFIC AND SEQUENCE OF CONSTRUCTION**

WT:CEW:VCM:CGT	8 of 9	11/19/22
----------------	--------	----------

Phase 3 Maintenance of Traffic – The Huron/Main intersection will be closed to thru traffic in both the northbound and southbound directions. Huron Street will be closed in the eastbound direction and will be reduced to a single northern lane in the westbound direction. All lane closures within the Main/Huron intersection will require the Contractor to submit a lane closure notification the Michigan Department of Transportation, in addition to the lane closure permit required by the City of Ann Arbor. Construction and staging for this phase shall be limited to the Huron/Main intersection and 15-ft south of the southern Huron Street right-of-way. South Main Street shall remain open to local traffic from Huron to Washington, and remain open to all traffic south of Washington. Access for emergency traffic will be maintained at all times. This phase will be used for all proposed work in the Huron/Main intersection.

The contractor should also be aware of the following events within the project area. If the project is delayed, the contractor will be required to make provisions following the “**Ann Arbor Art Fair**” paragraph herein:

- June 22: Mott’s Event (Main St from William to Liberty)
- July 4: Parade (Main St from William to Liberty)
- August: Two destination Ann Arbor events (Main St from William to Liberty)
- September: Car Show (Main St from William to Washington)
- September: Taste of Ann Arbor (Main St from William to Washington)

**Measurement and Payment.**- The estimated quantities for maintaining traffic is based on the maintenance of traffic plans. Any additional signing, traffic control devices, pavement markings, or the like required to expedite the construction, beyond that which is specified, shall be at the Contractor's sole expense.

The completed work as measured shall be paid at the Contract unit price for the following Contract pay items:

<b><u>Contract Item (Pay Item)</u></b>	<b><u>Pay Unit</u></b>
Traffic Regulator Control .....	Lump Sum
Barricade, Type III, High Intensity, Double Sided, Lighted, Furn .....	Ea
Barricade, Type III, High Intensity, Double Sided, Lighted, Oper .....	Ea
Plastic Drum, Fluorescent, Furn .....	Ea
Plastic Drum, Fluorescent, Oper .....	Ea
Sign, Type B, Temp, Prismatic, Furn .....	Sft
Sign, Type B, Temp, Prismatic, Oper .....	Sft
Sign, Type B, Temp, Prismatic, Spec, Furn .....	Sft
Sign, Type B, Temp, Prismatic, Spec, Oper .....	Sft

DETAILED SPECIFICATION  
FOR  
**MAINTAINING TRAFFIC AND SEQUENCE OF CONSTRUCTION**

WT:CEW:VCM:CGT	9 of 9	11/19/22
----------------	--------	----------

Sign, Portable, Changeable Message, NTCIP Compliant, Furn & Oper .....	Ea
Lighted Arrow, Type C, Furn & Oper .....	Ea
Sign Cover.....	Ea

The unit price for this item of work shall include all labor, material, and equipment costs required to perform the work specified herein and includes both furnishing and operating the devices.



**DISTANCE BETWEEN TRAFFIC SIGNS, "D"**

"D" DISTANCES	POSTED SPEED LIMIT, MPH (PRIOR TO WORK AREA)										
	25	30	35	40	45	50	55	60	65	70	75
D (FEET)	250	300	350	400	450	500	550	600	650	700	750

**GUIDELINES FOR LENGTH OF LONGITUDINAL BUFFER SPACE, "B"**

"B" LENGTHS	SPEED*, MPH (PRIOR TO WORK AREA)											
	20	25	30	35	40	45	50	55	60	65	70	75
B (FEET)	33	50	83	132	181	230	279	329	411	476	542	625

\* POSTED SPEED, OFF-PEAK 85TH PERCENTILE SPEED PRIOR TO WORK STARTING, OR THE ANTICIPATED OPERATING SPEED.

**MINIMUM MERGING TAPER LENGTH, "L" (FEET)**

OFFSET (FEET)	POSTED SPEED LIMIT, MPH (PRIOR TO WORK AREA)										
	25	30	35	40	45	50	55	60	65	70	75
1	11	15	21	27	45	50	55	60	65	70	75
2	21	30	41	54	90	100	110	120	130	140	150
3	32	45	62	80	135	150	165	180	195	210	225
4	42	60	82	107	180	200	220	240	260	280	300
5	53	75	103	134	225	250	275	300	325	350	375
6	63	90	123	160	270	300	330	360	390	420	450
7	73	105	143	187	315	350	385	420	455	490	525
8	84	120	164	214	360	400	440	480	520	560	600
9	94	135	184	240	405	450	495	540	585	630	675
10	105	150	205	267	450	500	550	600	650	700	750
11	115	165	225	294	495	550	605	660	715	770	825
12	125	180	245	320	540	600	660	720	780	840	900
13	136	195	266	347	585	650	715	780	845	910	975
14	146	210	286	374	630	700	770	840	910	980	1050
15	157	225	307	400	675	750	825	900	975	1050	1125

NOT TO SCALE

	NOT TO SCALE	MAINTAINING TRAFFIC TYPICAL	<b>"B", "D" AND "L" TABLES</b> <b>CHANNELIZING DEVICE SPACING,</b> <b>SIGN BORDER KEY, AND ROLL-AHEAD SPACING</b>	DATE: MAY 2021
		NO: 101-GEN-SPACING-CHARTS		SHEET: 1 OF 3

FILE: 101-GEN-SPACING-CHARTS.dgn

THE FORMULAS FOR THE MINIMUM LENGTH OF A MERGING TAPER IN DERIVING THE "L" VALUES SHOWN IN THE ABOVE TABLES ARE AS FOLLOWS:

"L" =  $\frac{W \times S^2}{60}$  WHERE POSTED SPEED PRIOR TO THE WORK AREA IS 40 MPH OR LESS

"L" = W X S WHERE POSTED SPEED PRIOR TO THE WORK AREA IS 45 MPH OR GREATER

L = MINIMUM LENGTH OF MERGING TAPER  
 S = POSTED SPEED LIMIT IN MPH PRIOR TO WORK AREA  
 W = WIDTH OF OFFSET

TYPES OF TAPERS

**UPSTREAM TAPERS**

- MERGING TAPER
- SHIFTING TAPER
- SHOULDER TAPER
- 2 TO 1 LANE ROAD TAPER

TAPER LENGTH

- L - MINIMUM
- 1/2 L - MINIMUM
- 1/3 L - MINIMUM
- 100' - MAXIMUM

**DOWNSTREAM TAPERS**  
 (USE IS RECOMMENDED)

100' (PER LANE)

**MAXIMUM SPACING FOR CHANNELIZING DEVICES**

WORK ZONE SPEED LIMIT	DRUM AND 42" DEVICE SPACING (FT)		NIGHTTIME 42" DEVICE SPACING (FT)	
	TAPER	TANGENT	TAPER	TANGENT
< 45 MPH	1 x SPEED LIMIT	2 x SPEED LIMIT	25 FEET	50 FEET
≥ 45 MPH	50 FEET	100 FEET	25 FEET	50 FEET

**SIGN OUTLINE KEY**

DASHED OUTLINES INDICATE A SIGN THAT EXISTS ON SITE, AND NEEDS TO BE COVERED.

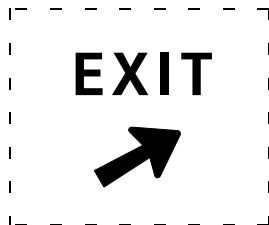

SOLID OUTLINES INDICATE A SIGN THAT IS TO BE PLACED ON THE PROJECT



NOT TO SCALE

	NOT TO SCALE	MAINTAINING TRAFFIC TYPICAL	<b>"B", "D" AND "L" TABLES</b> <b>CHANNELIZING DEVICE SPACING</b> <b>SIGN BORDER KEY AND ROLL-AHEAD SPACING</b>	DATE: MAY 2021
		NO: 101-GEN-SPACING-CHARTS		SHEET: 2 OF 3

FILE: 101-GEN-SPACING-CHARTS.dgn

GUIDELINES FOR ROLL-AHEAD DISTANCES FOR TMA VEHICLES – TEST LEVEL 2

WEIGHT OF TMA VEHICLE	PREVAILING SPEED (POSTED SPEED PRIOR TO WORK ZONE)	ROLL-AHEAD DISTANCE* (DISTANCE FROM FRONT OF TMA VEHICLE TO WORK AREA)
5.5 TONS (STATIONARY)	40 MPH OR LESS	25 FT

\* ROLL-AHEAD DISTANCES ARE CALCULATED USING A 4,410 POUND IMPACT VEHICLE WEIGHT.

GUIDELINES FOR ROLL-AHEAD DISTANCES FOR TMA VEHICLES – TEST LEVEL 3

WEIGHT OF TMA VEHICLE	PREVAILING SPEED (POSTED SPEED PRIOR TO WORK ZONE)	ROLL-AHEAD DISTANCE* (DISTANCE FROM FRONT OF TMA VEHICLE TO WORK AREA)
5 TONS (MOBILE)	45 MPH	100 FT
	50-55 MPH	150 FT
	60-75 MPH	175 FT
12 TONS (STATIONARY)	45 MPH	25 FT
	50-55 MPH	25 FT
	60-75 MPH	50 FT

\* ROLL-AHEAD DISTANCES ARE CALCULATED USING A 10,000 POUND IMPACT VEHICLE WEIGHT.



NOT TO SCALE

MAINTAINING TRAFFIC TYPICAL

NO: 101-GEN-SPACING-CHARTS

"B", "D" AND "L" TABLES  
CHANNELIZING DEVICE SPACING  
SIGN BORDER KEY AND ROLL AHEAD SPACING

DATE: MAY 2021

SHEET: 3 OF 3

**THE FOLLOWING NOTES APPLY IF CALLED FOR ON THE TRAFFIC TYPICAL**

**GENERAL NOTES**

- G1: SEE GEN-SPACING-CHARTS FOR COMMON VALUES INCLUDING:  
 D = DISTANCE BETWEEN TRAFFIC CONTROL DEVICES  
 L = MINIMUM LENGTH OF TAPER  
 B = LENGTH OF LONGITUDINAL BUFFER  
 ROLL AHEAD DISTANCE
- G2: DISTANCE BETWEEN SIGNS, "D", THE VALUES FOR WHICH ARE SHOWN IN TYPICAL GEN-KEY ARE APPROXIMATE AND MAY NEED ADJUSTING AS DIRECTED BY THE ENGINEER.
- G3: ALL TEMPORARY SIGNS, TYPE III BARRICADES, THEIR SUPPORT SYSTEMS AND LIGHTING MUST MEET NATIONAL COOPERATIVE HIGHWAY RESEARCH PROGRAM REPORT 350 (NCHRP 350) TEST LEVEL 3, OR MANUAL FOR ASSESSING SAFETY HARDWARE (MASH) TL-3 AS WELL AS THE CURRENT EDITION OF THE MICHIGAN MANUAL ON UNIFORM TRAFFIC CONTROL DEVICES, THE CURRENT EDITION OF THE STANDARD SPECIFICATIONS FOR CONSTRUCTION, THE STANDARD PLANS AND APPLICABLE SPECIAL PROVISIONS. ONLY DESIGNS AND MATERIALS APPROVED BY MDOT WILL BE ALLOWED.
- G4: DO NOT STORE EQUIPMENT, MATERIALS OR PERFORM WORK IN ESTABLISHED BUFFER AREAS.
- G5: ALL EXISTING PAVEMENT MARKINGS WHICH ARE IN CONFLICT WITH EITHER PROPOSED CHANGES IN TRAFFIC PATTERNS OR PROPOSED TEMPORARY TRAFFIC MARKINGS SHALL BE REMOVED BEFORE ANY CHANGE IS MADE IN THE TRAFFIC PATTERN. EXCEPTION WILL BE MADE FOR TRAFFIC PATTERNS FOR WORK LESS THAN THREE DAYS THAT ARE ADEQUATELY DELINEATED BY OTHER TRAFFIC CONTROL DEVICES.

**SIGN NOTES**

- S1: ALL NON-APPLICABLE SIGNING WITHIN THE CIA MUST BE MODIFIED TO FIT CONDITIONS, COVERED, OR REMOVED. FOR GUIDANCE SEE THE WORK ZONE SAFETY AND MOBILITY MANUAL, SECTIONS 6.01.09 AND 6.01.10.
- S2: R5-18b SIGNS ARE ONLY REQUIRED ON FREEWAY PROJECTS WITH A DURATION OF 15 DAYS OR LONGER OR NON-FREEWAY PROJECTS WITH A DURATION OF 90 DAYS OR LONGER. TO APPLY THIS TYPICAL WITHOUT R5-18b SIGNS, REMOVE THE SIGNS AND CONSOLIDATE THE SEQUENCE AS APPROPRIATE.
- S3: R5-18c IS ONLY REQUIRED IN THE INITIAL SIGNING SEQUENCE IN THE WORK ZONE. OMIT THIS SIGN IN SUBSEQUENT SEQUENCES IN THE SAME WORK ZONE.
- S4: ADDITIONAL SIGNING AND/OR ELONGATED SIGNING SEQUENCES SHOULD BE USED WHEN TRAFFIC VOLUMES ARE SIGNIFICANT ENOUGH TO CREATE BACKUPS BEYOND THE W20-5 SIGNS.
- S5: PLACE ADDITIONAL SPEED LIMIT SIGNS REFLECTING THE WORK ZONE SPEED AFTER EACH MAJOR CROSSROAD THAT INTERSECTS THE WORK ZONE, OR AFTER EACH ENTRANCE RAMP THAT COMES ONTO THE FREEWAY WHERE THE REDUCED SPEED IS IN EFFECT. PLACE ADDITIONAL SPEED LIMIT SIGNS AT INTERVALS ALONG THE ROADWAY SUCH THAT NO SPEED LIMIT SIGNS ARE MORE THAN 2 MILES APART. WHEN REDUCED SPEED LIMITS ARE UTILIZED IN THE WORK AREA, PLACE ADDITIONAL SPEED LIMIT SIGNS RETURNING TRAFFIC TO ITS NORMAL SPEED BEYOND THE LIMITS OF THE WORK AREA AS INDICATED. IF PERMANENT SIGNS DISPLAYING THE CORRECT SPEED LIMIT ARE POSTED, OMIT ALL W3-5b AND R2-1 SIGNS AND REDUCE SPACING ACCORDINGLY.
- S6: FABRICATE SPECIAL SIGNS IN ACCORDANCE WITH CURRENT SIGNING DESIGN STANDARDS.
- S7: PLACE ADDITIONAL R8-3 SIGNS AT A MAXIMUM 500' SPACING THROUGHOUT THE WORK ZONE.
- S8: WHEN SPEED LIMIT SIGNS CANNOT BE PLACED SIDE BY SIDE AS SHOWN, PLACE THEM "D" DISTANCE APART.
- S9: STOP SIGNS NOT REQUIRED IF SIGNALS ARE ON 4-WAY FLASHING RED. STOP AHEAD SIGNS ARE NOT REQUIRED IF THERE IS ADEQUATE VISIBILITY OF THE STOP SIGN OR IF SIGNALS ARE BEING USED TO CONTROL TRAFFIC.
- S10: PLACE REDUCED SPEED ZONE AHEAD SIGN (W3-5b) HERE WHEN USING A SPEED REDUCTION IN THIS DIRECTION.
- S11: THE NUMBER OF W1-6 SHIFT SIGNS TO PLACE FOR A SHIFT IS AS FOLLOWS:  
 SHIFTS 4FT OR LESS, PLACE ONE W1-6(R)(L)  
 SHIFTS 5FT TO 12FT, PLACE TWO W1-6(R)(L)  
 SHIFTS MORE THAN 12FT, PLACE THREE OR MORE W1-6(R)(L) SIGNS DEPENDING UPON LENGTH OF SHIFT AND AS PER THE ENGINEER.
- S12: PLACE R2-1 SIGNS AS DETAILED IN NOTE S5 WHEN THERE IS A SPEED REDUCTION IN THIS DIRECTION

**TRAFFIC REGULATOR NOTES**

- TR1: TRAFFIC REGULATORS MUST FOLLOW ALL THE REQUIREMENTS IN THE STANDARD SPECIFICATIONS, THE STANDARD PLANS AND APPLICABLE SPECIAL PROVISIONS, THE CURRENT VERSIONS OF THE TRAFFIC REGULATOR'S INSTRUCTION MANUAL AND THE VIDEO "HOW TO SAFELY REGULATE TRAFFIC IN MICHIGAN". THE MAXIMUM DISTANCE BETWEEN THE TRAFFIC REGULATORS IS DETERMINED BY THE ROADWAY ADT, GEOMETRICS, AND AS DIRECTED BY THE ENGINEER.
- TR2: PROVIDE APPROPRIATE BALLOON LIGHTING TO SUFFICIENTLY ILLUMINATE TRAFFIC REGULATOR'S STATIONS WHEN TRAFFIC REGULATING IS ALLOWED DURING THE HOURS OF DARKNESS.
- TR3: PROVIDE EITHER A STOP/SLOW AFAD OR A RED/YELLOW LENS AFAD, MEETING THE REQUIREMENTS OF THE MMUTCD

**TEMPORARY TRAFFIC CONTROL DEVICE NOTES**

- TCD1: THE MAXIMUM DISTANCE IN FEET BETWEEN CHANNELIZING DEVICES IN A TAPER SHOULD NOT EXCEED 1.0 TIMES THE WORK ZONE SPEED LIMIT IN MPH FOR ROADWAYS WITH A POSTED WORK ZONE SPEED LIMIT LESS THAN 45 MPH AND SHOULD NOT EXCEED 50 FEET ON ROADWAYS WITH A POSTED WORK ZONE SPEED LIMIT OF 45 MPH OR GREATER. THE SPACING FOR 42 INCH CHANNELIZING DEVICE TAPERS ARE NOT TO EXCEED 25 FEET AT NIGHT.
- TCD2: THE MAXIMUM DISTANCE IN FEET BETWEEN CHANNELIZING DEVICES IN A TANGENT SHOULD NOT EXCEED TWICE THE WORK ZONE SPEED LIMIT IN MPH FOR ROADWAYS WITH A POSTED WORK ZONE SPEED LIMIT LESS THAN 45 MPH AND SHOULD NOT EXCEED 100 FEET ON ROADWAYS WITH A POSTED WORK ZONE SPEED LIMIT OF 45 MPH OR GREATER. THE SPACING FOR 42 INCH CHANNELIZING DEVICE TANGENTS ARE NOT TO EXCEED 50 FEET AT NIGHT.
- TCD3: TYPE III BARRICADES MUST BE LIGHTED FOR OVERNIGHT CLOSURES.
- TCD4: WHEN THE HAUL ROAD IS NOT IN USE, PLACE LIGHTED TYPE III BARRICADES WITH "ROAD CLOSED" EXTENDING COMPLETELY ACROSS THE HAUL ROAD.
- TCD5: USE OBJECT MARKER SIGNS IN LIEU OF THE TYPE B HIGH INTENSITY LIGHT SHOWN IN THE STANDARD PLAN FOR TEMPORARY CONCRETE BARRIER (R-53, AND R-126) WHEN USED WITH A TEMPORARY SIGNAL SYSTEM. THE OBJECT MARKERS MUST BE A MINIMUM OF 12 INCHES IN WIDTH AND 36 INCHES IN HEIGHT AND HAVE ORANGE AND WHITE RETROREFLECTIVE SHEETING. THE RETROREFLECTIVE SHEETING MUST HAVE ALTERNATING DIAGONAL ORANGE AND WHITE STRIPES SLOPING DOWNWARD AT AN ANGLE OF 45 DEGREES IN THE DIRECTION VEHICULAR TRAFFIC IS TO PASS.
- TCD6: PLACE LIGHTED ARROW PANELS AS CLOSE TO THE BEGINNING OF TAPERS AS PRACTICAL, BUT NOT IN A MANNER THAT WILL OBSCURE OR CONFUSE APPROACHING MOTORISTS WHEN PHYSICAL LIMITATIONS RESTRICT PLACEMENT. IN CURBED SECTIONS, IF ARROW BOARD CANNOT BE PLACED BEHIND CURB, PLACE ARROW BOARD IN THE CLOSED LANE AS CLOSE TO THE BEGINNING OF TAPER AS POSSIBLE.
- TCD7: ADDITIONAL TYPE III BARRICADES MAY BE REQUIRED TO COMPLETELY CLOSE OFF ROAD FROM EDGE OF PAVEMENT TO EDGE OF PAVEMENT.
- TCD8: WHERE THE SHIFTED SECTION IS SHORTER THAN 600 FEET, A DOUBLE REVERSE CURVE SIGN (W24-1) CAN BE USED INSTEAD OF THE FIRST REVERSE CURVE SIGN, AND THE SECOND REVERSE CURVE SIGN CAN BE OMITTED.
- TCD9: RUMBLE STRIPS ARE TO BE PLACED AS SPECIFIED IN THE CONTRACT. IF NOT SPECIFIED IN THE CONTRACT, PLACE RUMBLE STRIPS AS SHOWN, AND IN ACCORDANCE WITH THE RUMBLE STRIP MANUFACTURER'S RECOMMENDATIONS. AN ARRAY OF RUMBLE STRIPS CONTAINS THREE RUMBLE STRIPS. PLACE THE RUMBLE STRIPS IN THE ARRAY AT A CONSISTENT DISTANCE, BETWEEN 10' AND 20' APART.
- TCD10: SEE THE WORK ZONE SAFETY AND MOBILITY MANUAL, PORTABLE CHANGEABLE MESSAGE SIGN GUIDELINES FOR RECOMMENDED AND CORRECT PCMS MESSAGING. STAGGER PCMS THAT ARE ON OPPOSING SIDES OF THE ROAD 1000 FEET FROM EACH OTHER.

**RAMP NOTES**

- RMP1: WHEN CONDITIONS ALLOW, E5-1 SIGNS MUST BE REMOVED OR COVERED AND CHANNELIZING DEVICES MUST BE POSITIONED TO ENABLE RAMP TRAFFIC TO DIVERGE IN A FREE MANNER
- RMP2: STOP AND YIELD CONDITIONS SHOULD BE AVOIDED WHENEVER PRACTICAL. WHEN CONDITIONS WARRANT, R1-1 SIGNS MAY BE USED IN PLACE OF R1-2 SIGNS. WHEN R-1 SIGNS ARE USED, W3-1 SIGNS MUST BE USED IN PLACE OF W3-2 SIGNS. CONSIDERATION SHOULD BE GIVEN TO CLOSING THE RAMP TO COMPLETE WORK TO ALLOW AN ADEQUATE MERGE DISTANCE. WORK SHOULD BE EXPEDITED TO AVOID THE STOP AND/OR YIELD CONDITIONS.

	NOT TO SCALE	MAINTAINING TRAFFIC TYPICAL		<p align="center"><b>TRAFFIC TYPICALS NOTE SHEET</b></p>	DATE: MAY 2022
		NO: <b>102-GEN-NOTES</b>			SHEET: <b>1 OF 2</b>

FILE: 102-GEN-NOTES.dgn

THE FOLLOWING NOTES APPLY IF CALLED FOR ON THE TRAFFIC TYPICAL

**SIGNAL NOTES**

- SIG1: EXISTING SIGNAL MUST BE EITHER 4-WAY FLASHING RED, BAGGED, OR TURNED OFF.
- SIG2: SIGNAL IS IN OPERATION.
- SIG3: DELINEATE THE WORK ZONE AREA WITH 28 INCH CONES FOR DAYTIME WORK, OR 42 INCH CHANNELIZING DEVICES FOR NIGHTTIME WORK.
- SIG4: THE CONTRACTOR MUST HAVE A DESIGNATED SPOTTER IF THE AERIAL BUCKET TRUCK IS LOCATED OVER ACTIVE TRAVEL LANES.
- SIG5: THE LOWEST POINT OF THE BUCKET MAY NOT TRAVEL BELOW 14 FOOT VERTICAL CLEARANCE. THE CONTRACTOR MUST UTILIZE AN ALTERNATE SET UP, OR PLACE THE INTERSECTION IN A 4 WAY STOP IF THE 14 FOOT VERTICAL CLEARANCE IS COMPROMIZED. USE TRAFFIC REGULATORS TO CONTROL TRAFFIC THROUGH THE INTERSECTION WHEN TRAFFIC IS PLACED IN A 4 WAY STOP.
- SIG6: DELINEATE THE TRUCK WITH CHANNELIZING DEVICES. THE POSITION OF THE TRUCK MAY BE MOVED TO FACILITATE WORK.

**MAINTENANCE AND SURVEYING NOTES**

- MS1: WHENEVER STOPPING SIGHT DISTANCE EXISTS TO THE REAR, THE SHADOW VEHICLES SHOULD MAINTAIN THE RECOMENDED DISTANCE FROM THE WORK AREA AND PROCEED AT THE SAME SPEED. THE SHADOW VEHICLE SHOULD SLOW DOWN AND TRAVEL AT A FARTHER DISTANCE TO PROVIDE ADEQUATE SIGHT DISTANCE IN ADVANCE OF VERTICAL OR HORIZONTAL CURVES.
- MS2: WORKERS OUTSIDE OF VEHICLES SHOULD WORK WITHIN 150' OF WORK VEHICLES WITH AN ACTIVATED BEACON, BETWEEN THE "BEGIN WORK CONVOY" SIGN AND THE "END WORK CONVOY" SIGN, OR BETWEEN THE "WORK ZONE BEGINS" AND "END ROAD WORK" SIGN.
- MS3: WORK OR SHADOW VEHICLES WITH OR WITHOUT A TMA MAY BE USED TO SEPARATE THE WORK SPACE FROM TRAFFIC. IF USED, THE VEHICLES SHOULD BE PARKED ACCORDING TO THE ROLL AHEAD DISTANCE TABLES.
- MS4: WORK AND SHADOW VEHICLES SHALL BE APPROPRIATELY EQUIPPED WITH AN ACTIVATED AMBER BEACON.
- MS5: WHEN WORKERS ARE OUTSIDE THEIR VEHICLES IN AN EXISTING LANE WHILE A MOBILE OPERATION IS OCCURRING DURING THE NIGHTTIME HOURS, CHANNELIZING DEVICES TO DELINEATE OPEN OR CLOSED LANES AT 50 FT SPACING MUST BE USED. AN EXAMPLE OF AN OPERATION (BUT NOT LIMITED TO) IS THE LAYOUT OF CONCRETE PATCHES.
- MS6: W21-6 AND W20-1 SIGNS MAY BE SUBSTITUTED AS DETERMINED BY THE TYPE OF WORK TAKING PLACE AS PER THE ENGINEER.



NOT TO SCALE

MAINTAINING TRAFFIC TYPICAL

NO: 102-GEN-NOTES







TRAFFIC TYPICALS  
NOTE SHEET

DATE: MAY 2022  
SHEET:

2 OF 2

FILE: 102-GEN-NOTES.dgn

# KEY

-  TRAFFIC REGULATOR
-  CHANNELIZING DEVICES
-  LIGHTED ARROW PANEL (CAUTION MODE)
-  TRAFFIC FLOW
-  REFLECTS EXISTING SPEED LIMIT
-  PLACE SIGN AS INDICATED IN NOTE S5
-  PLACE SIGN AS INDICATED IN NOTE S2

## STANDARD NOTES

(SEE GEN-NOTES)

GENERAL: G1, G2, G3, G4  
 SIGNING: S1, S2, S3, S4, S5  
 TRAF REG: TR1, TR2  
 DEVICES: TCD1, TCD2, TCD6

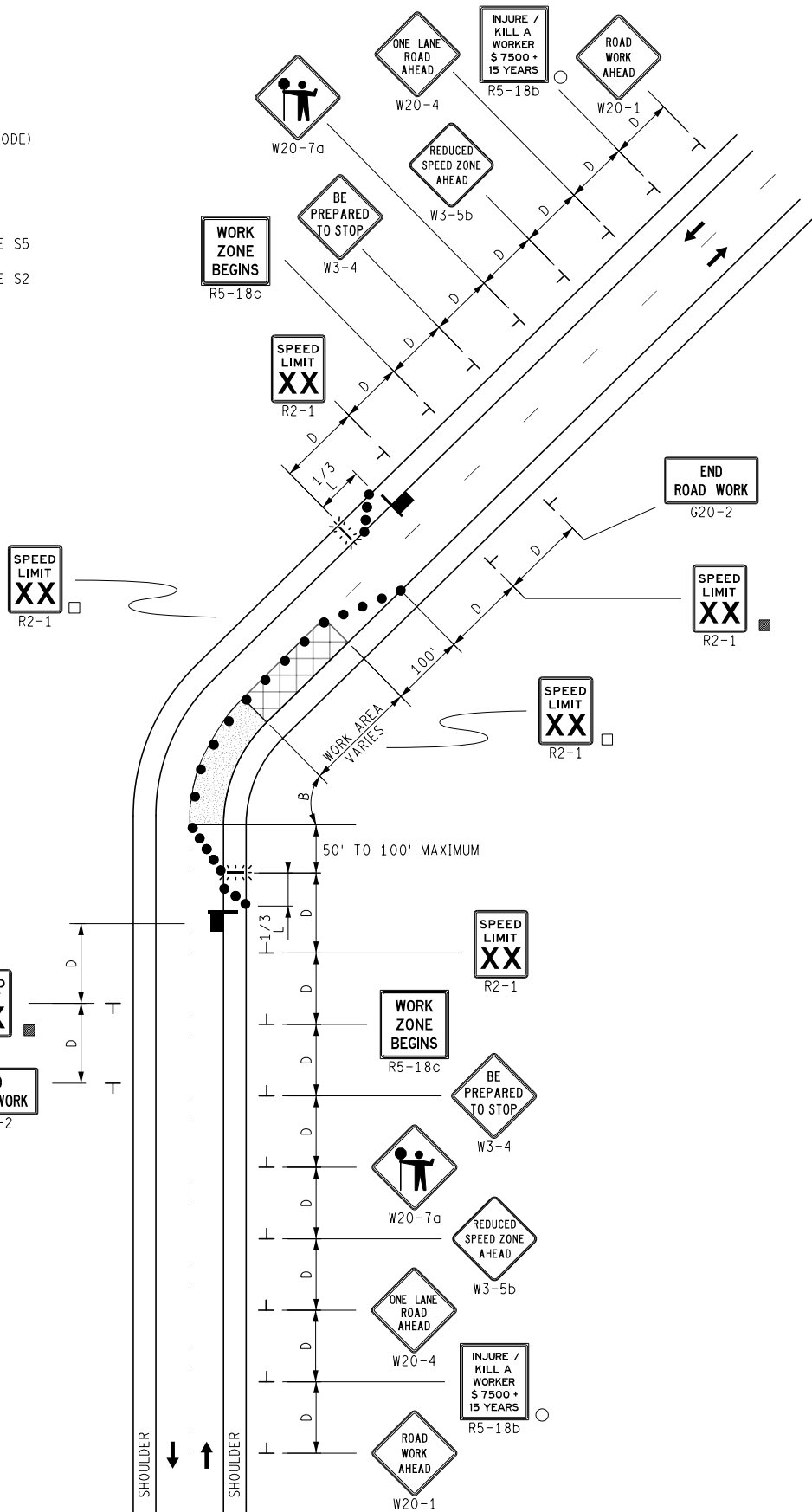

	NOT TO SCALE	MAINTAINING TRAFFIC TYPICAL	<b>LANE CLOSURE</b> UTILIZING TRAFFIC REGULATORS ON A 2-LANE UNDIVIDED ROADWAY	DATE: MAY 2021
		NO: <b>110-TR-NFW-2L</b>		SHEET: 1 OF 1

### KEY

- CHANNELIZING DEVICES
- ← TRAFFIC FLOW
- REFLECTS EXISTING SPEED LIMIT
- PLACE SIGN AS INDICATED IN NOTE S5
- PLACE SIGN AS INDICATED IN NOTE S2

### STANDARD NOTES

(SEE 102-GEN-NOTES)

GENERAL: G1, G2, G3, G4, G5  
 SIGNING: S1, S2, S3, S5, S11  
 DEVICES: TCD1, TCD2, TCD6, TCD8

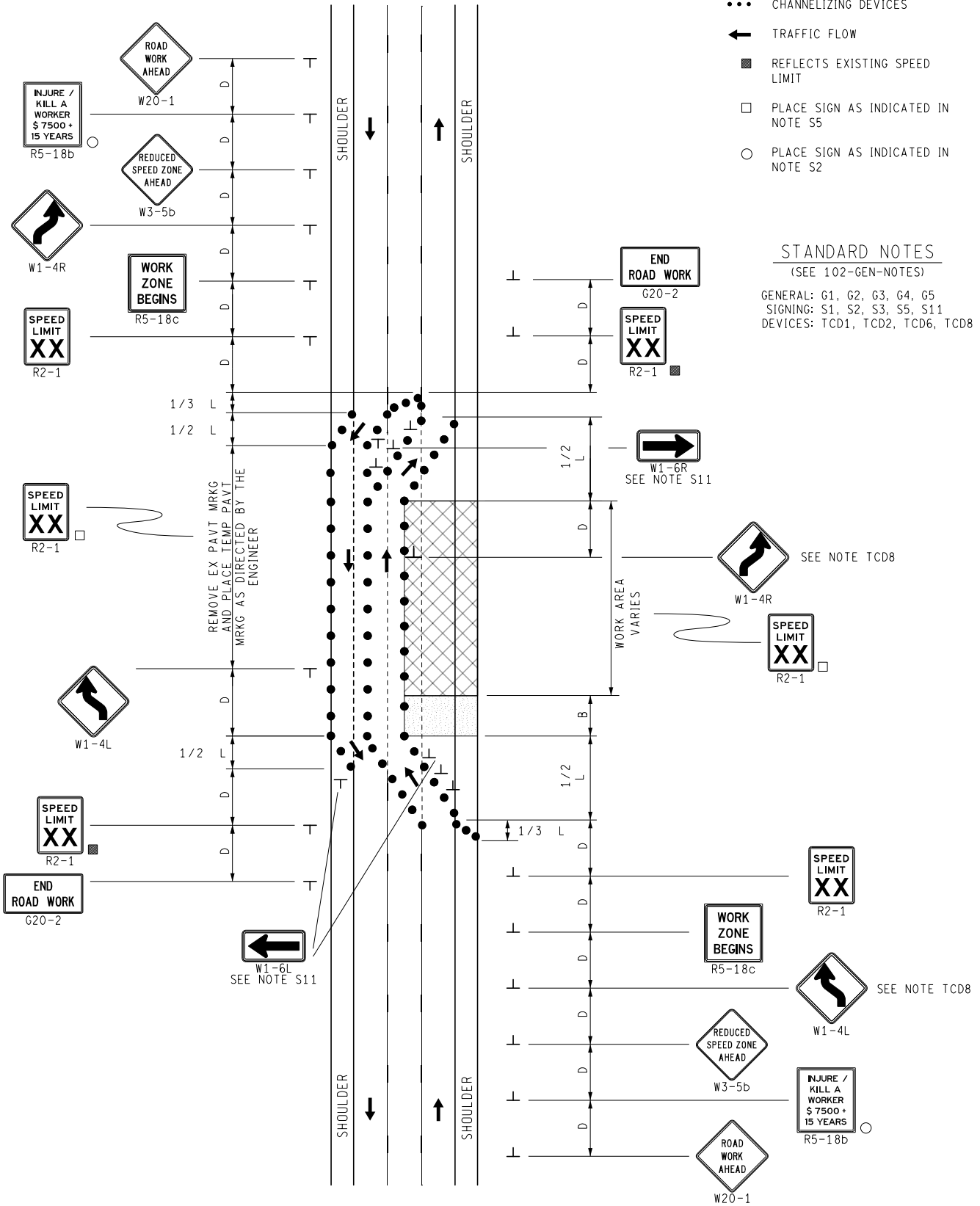

**KEY**

- CHANNELIZING DEVICES
- ← TRAFFIC FLOW
- REFLECTS EXISTING SPEED LIMIT
- PLACE SIGN AS INDICATED IN NOTE S5
- PLACE SIGN AS INDICATED IN NOTE S2

**STANDARD NOTES**

(SEE 102-GEN-NOTES)

GENERAL: G1, G2, G3, G4, G5  
 SIGNING: S1, S2, S3, S7, S11  
 DEVICES: TCD1, TCD2, TCD6, TCD8

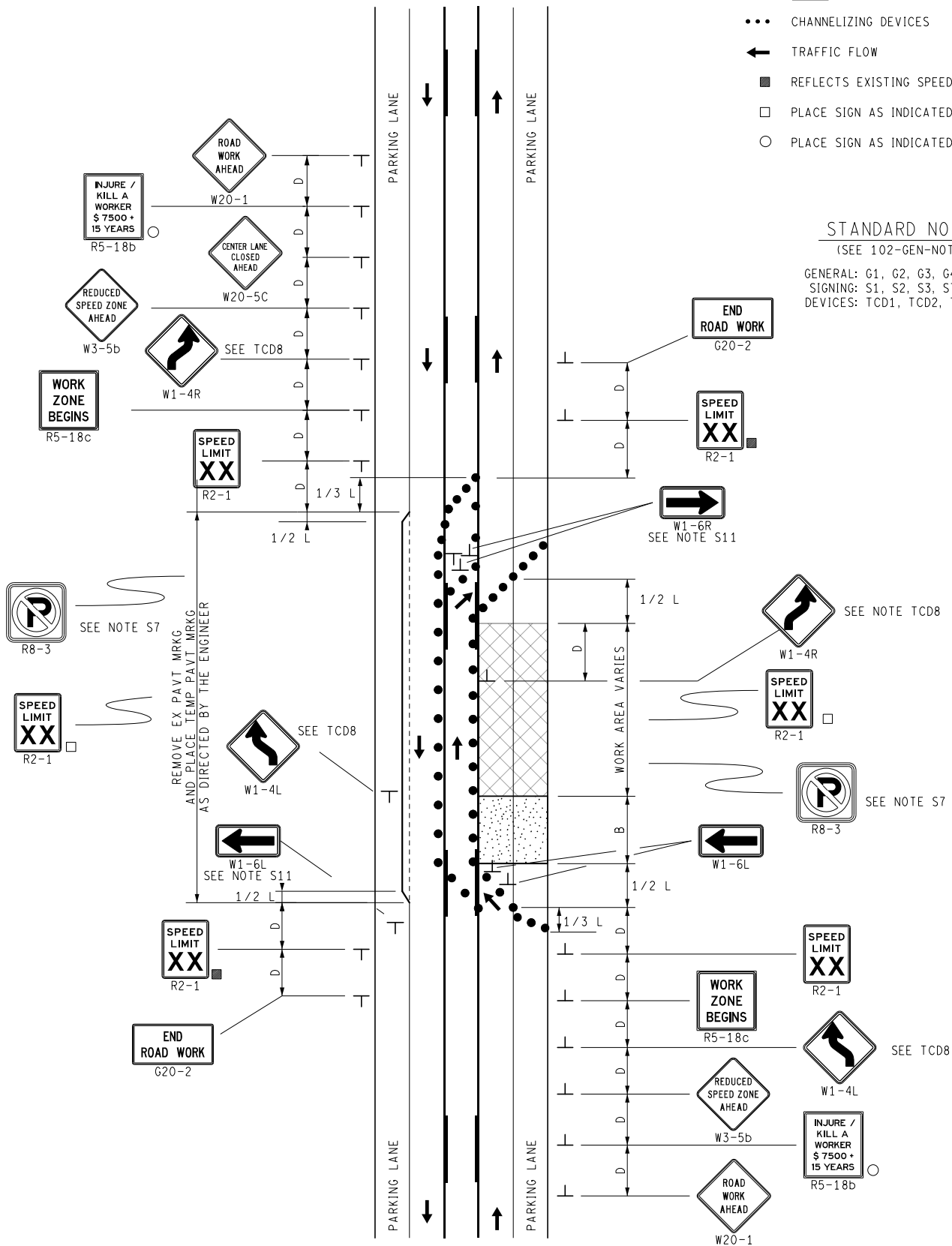

NOT TO SCALE

MAINTAINING TRAFFIC TYPICAL

NO:  
**140-CLT-PARK-LANE**

**LANE SHIFT AND PARKING LANE CLOSURE  
 WITH BOTH BOUNDS SHIFTED  
 ON AN UNDIVIDED ROADWAY**

DATE:  
 JUNE 2021

SHEET:

FILE: 140-CLT-PARK-LANE.dgn

1 OF 1



## SIGN MATERIAL SELECTION TABLE

SIGN SIZE	SIGN MATERIAL TYPE		
	TYPE I	TYPE II	TYPE III
≤ 36" X 36"		X	X
>36" X 36" ≤ 96" TO WIDE		X	
> 96" WIDE TO 144" WIDE	X	X	
> 144" WIDE	X		

TYPE I           ALUMINUM EXTRUSION  
 TYPE II          PLYWOOD  
 TYPE III         ALUMINUM SHEET

ROUNDING OF CORNERS IS NOT REQUIRED FOR TYPE I OR II SIGNS.  
 VERTICAL JOINTS ARE NOT PERMITTED.  
 HORIZONTAL JOINTS THROUGH SIGN LEGEND OR SYMBOLS ARE NOT PERMITTED.

## POST SIZE REQUIREMENTS TABLE

SIGN AREA (ft <sup>2</sup> )	POST TYPE		
	U-CHANNEL STEEL	SQUARE TUBULAR STEEL	WOOD
≤ 9	1 - 3 lb/ft*	1 - 2" 12 or 14 GA*	N/A
9 ≤ 20	2 - 3 lb/ft	2 - 2" 12 or 14 GA	1 - 4" X 6"*
> 20 ≤ 30	N/A	N/A	2 - 4" X 6"
> 30 ≤ 60	N/A	N/A	2 - 6" X 8"
> 60 ≤ 84	N/A	N/A	3 - 6" X 8"

\*SIGNS 4 FEET AND GREATER IN WIDTH REQUIRE 2 POSTS.  
 SIGNS GREATER THAN 8 FEET IN WIDTH REQUIRE 2 OR 3 WOOD  
 POSTS DEPENDING ON AREA OF SIGN.  
 A MAXIMUM OF 2 POSTS WITHIN A 7' PATH IS PERMITTED.

  PREPARED BY DESIGN DIVISION	DEPARTMENT DIRECTOR Kirk T. Steudle  APPROVED BY: _____ DIRECTOR, BUREAU OF FIELD SERVICES	MICHIGAN DEPARTMENT OF TRANSPORTATION BUREAU OF DEVELOPMENT STANDARD PLAN FOR  <b>GROUND DRIVEN SIGN SUPPORTS FOR TEMP SIGNS</b>		
	DRAWN BY: CON/ECH CHECKED BY: AUG	APPROVED BY: _____ DIRECTOR, BUREAU OF DEVELOPMENT	_____ F.H.W.A. APPROVAL	11/2/2017 PLAN DATE

## 2 POST SIGN SUPPORT SPACING

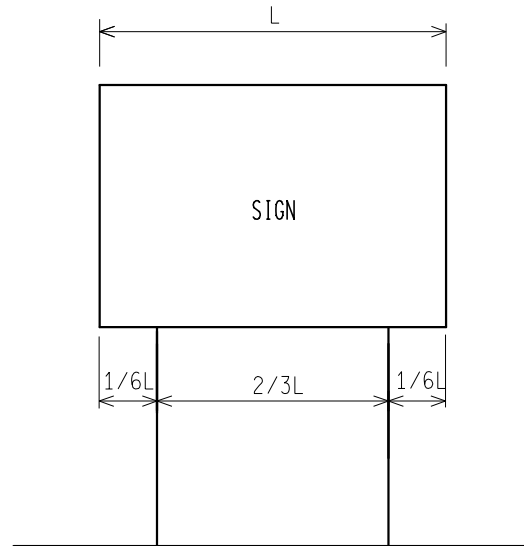

## 3 POST SIGN SUPPORT SPACING

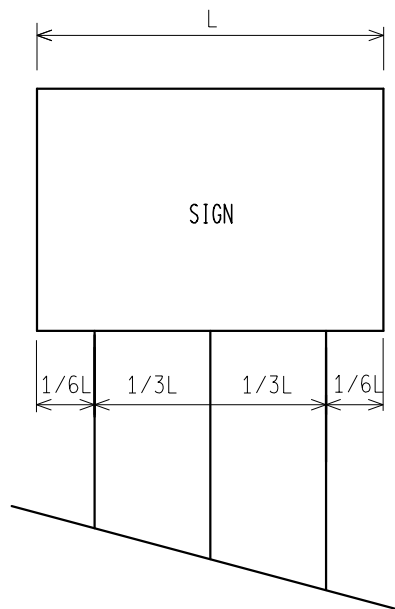

\* FOR ALL 11' AND 12' LONG SIGNS ON 3 WOOD SUPPORTS, SPREAD POSTS SO AS TO HAVE A 8' MIN. TO 9' MAX. DISTANCE BETWEEN OUTSIDE POSTS.

NOT TO SCALE

MICHIGAN DEPARTMENT OF TRANSPORTATION  
BUREAU OF DEVELOPMENT STANDARD PLAN

F.H.W.A. APPROVAL

11/2/2017  
PLAN DATE

WZD-100-A

SHEET  
2 OF 11

NOTE: THE ORIGINAL SIGNED COPY IS KEPT ON FILE AT THE MICHIGAN DEPARTMENT OF TRANSPORTATION.

DS-146

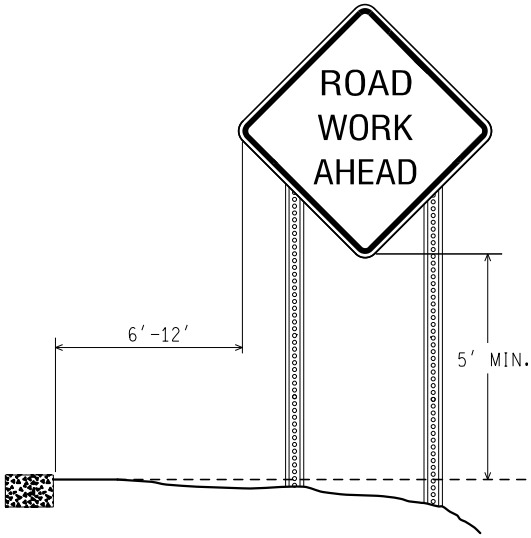

RURAL

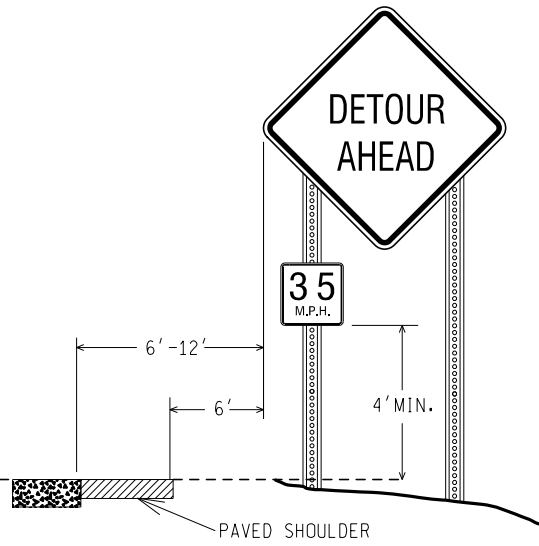

RURAL WITH ADVISORY SPEED PLATE

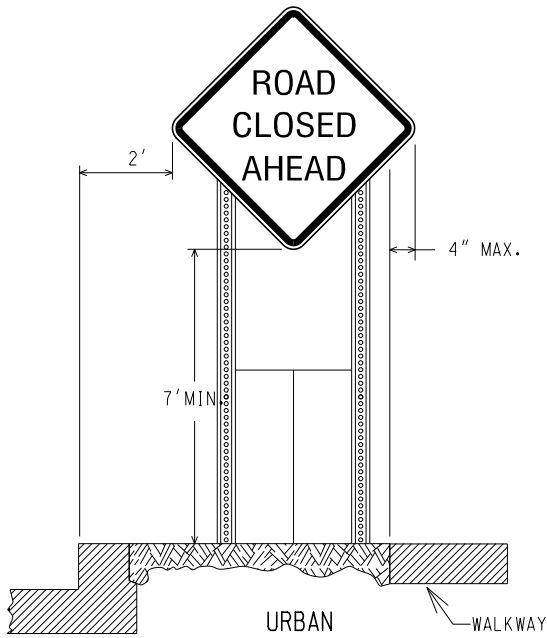

URBAN

(CURBED AREAS OR WHERE WALKWAYS ARE PRESENT)

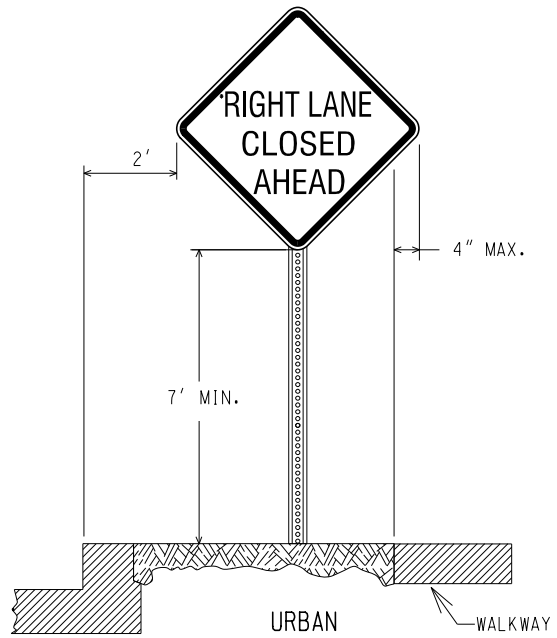

URBAN

(CURBED AREAS OR WHERE WALKWAYS ARE PRESENT)

BOTTOM HEIGHT AND OFFSET

NOT TO SCALE

MICHIGAN DEPARTMENT OF TRANSPORTATION  
BUREAU OF DEVELOPMENT STANDARD PLAN

F.H.W.A. APPROVAL

11/2/2017  
PLAN DATE

WZD-100-A

SHEET  
3 OF 11

NOTE: THE ORIGINAL SIGNED COPY IS KEPT ON FILE AT THE MICHIGAN DEPARTMENT OF TRANSPORTATION.

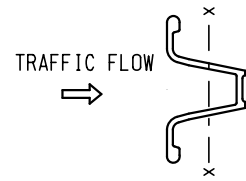
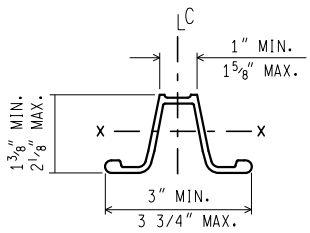
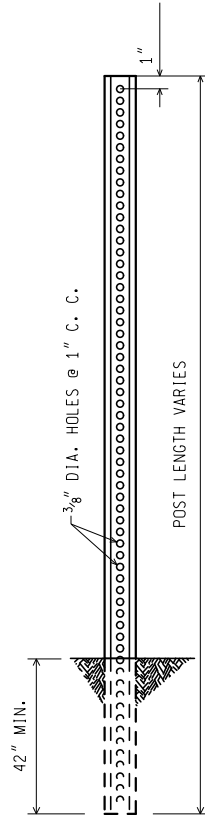

WEIGHT = 3 lbs/ft  
 SECT. MOD. X.-X. = 0.31 CUBIC INCHES MIN.

**3 lb. U - CHANNEL STEEL POST**  
 (NO SPLICE)

MOUNT SIGN ON OPEN FACE OF  
 U - CHANNEL STEEL POST

NOT TO SCALE

MICHIGAN DEPARTMENT OF TRANSPORTATION BUREAU OF DEVELOPMENT STANDARD PLAN	F.H.W.A. APPROVAL	11/2/2017 PLAN DATE	WZD-100-A	SHEET 4 OF 11
--	-------------------	------------------------	-----------	------------------

NOTE: THE ORIGINAL SIGNED COPY IS KEPT ON FILE AT THE MICHIGAN DEPARTMENT OF TRANSPORTATION.

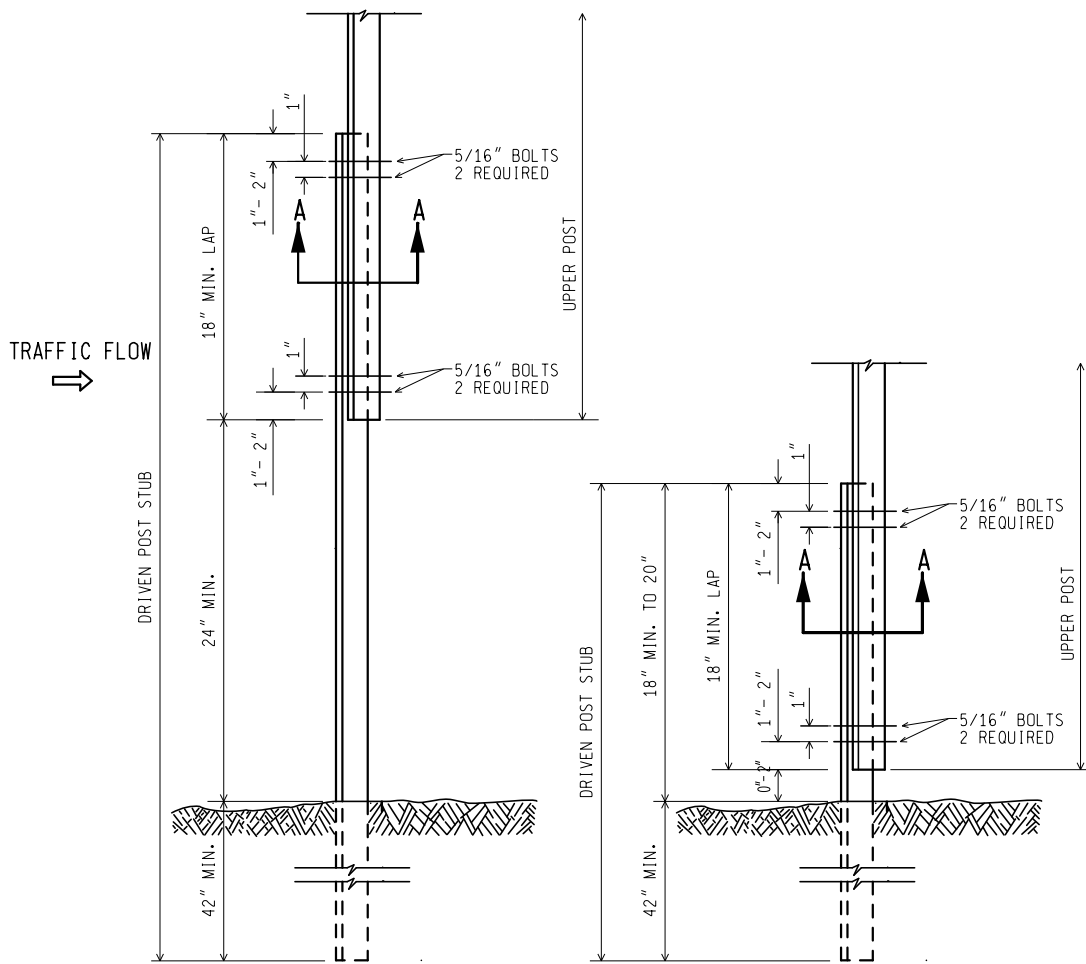

UPPER SPLICE

LOWER SPLICE

3 lb. U - CHANNEL STEEL POST  
(WITH SPLICE)

MOUNT SIGN ON OPEN FACE OF  
UPPER U - CHANNEL STEEL POST

NOT TO SCALE

MICHIGAN DEPARTMENT OF TRANSPORTATION  
BUREAU OF DEVELOPMENT STANDARD PLAN

F.H.W.A. APPROVAL

11/2/2017  
PLAN DATE

WZD-100-A

SHEET  
5 OF 11

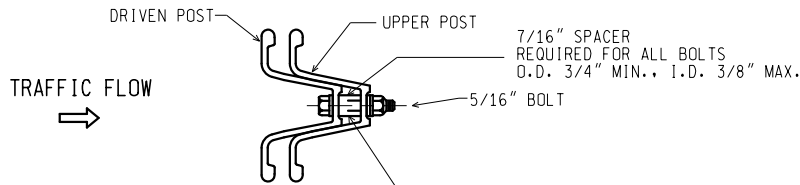

SECTION A-A

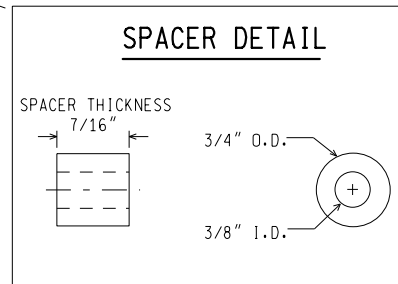

NOTES:

1. THE SPACER THICKNESS SHALL BE 1/16" LESS THAN THE GAP BETWEEN THE POST WHEN POSITIONED IN THE UNBOLTED CONFIGURATION.
2. THE EXTERIOR BOLT (CLOSEST TO LAP), SPACER, WASHER, AND NUT SHALL BE INSTALLED IN A PREPUNCHED HOLE 1" TO 2" FROM THE END OF THE LAP.
3. THE INTERIOR BOLT (FARTHEST FROM LAP), SPACER, WASHER, AND NUT SHALL BE INSTALLED IN THE NEXT PREPUNCHED HOLE.
4. THE DRIVEN POST SHALL ALWAYS BE MOUNTED IN FRONT OF THE UPPER POST WITH RESPECT TO THE ADJACENT ONCOMING TRAFFIC, REGARDLESS OF THE DIRECTION THE SIGN IS FACING.
5. THE SPLICE LAP SHALL BE FASTENED BY FOUR-5/16" DIA. GALVANIZED A449 BOLTS (SAE J429 GRADE 5) OR GALVANIZED A325 BOLTS.

3 lb. U - CHANNEL STEEL POST  
(WITH SPLICE)

NOT TO SCALE

MICHIGAN DEPARTMENT OF TRANSPORTATION BUREAU OF DEVELOPMENT STANDARD PLAN	F.H.W.A. APPROVAL	11/2/2017 PLAN DATE	WZD-100-A	SHEET 6 OF 11
--	-------------------	------------------------	-----------	------------------

NOTE: THE ORIGINAL SIGNED COPY IS KEPT ON FILE AT THE MICHIGAN DEPARTMENT OF TRANSPORTATION.

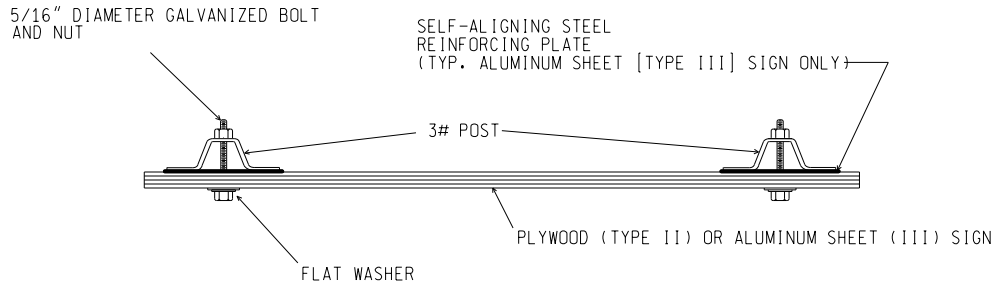

SIGN TO 3 lb. POST CONNECTION

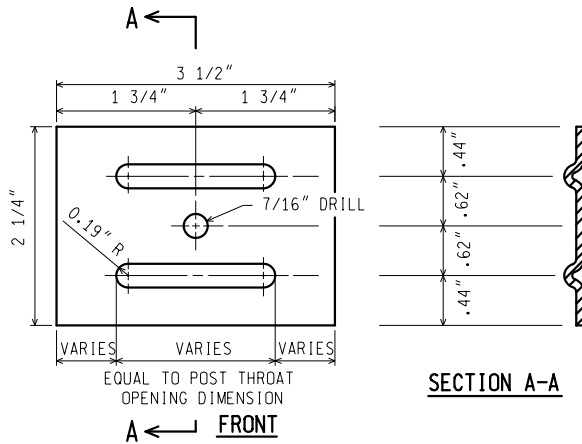

NOTES: (FOR STEEL SIGN REINF' PLATE)

1. MATERIAL: 12 GAUGE CARBON STEEL.
2. TOLERANCE ON ALL DIMENSIONS  $\pm 0.0625"$
3. FINISH-AFTER STAMPING AND PUNCHING, GALVANIZE ACCORDING TO CURRENT SPECIFICATIONS FOR ZINC (HOT GALVANIZE) COATINGS ON PRODUCTS FABRICATED FROM PLATES OR STRIPS

STEEL SIGN REINFORCING PLATE  
REQUIRED FOR TYPE III SIGNS ONLY

3 lb. U - CHANNEL STEEL POST SIGN CONNECTION

NOT TO SCALE

MICHIGAN DEPARTMENT OF TRANSPORTATION  
BUREAU OF DEVELOPMENT STANDARD PLAN

F.H.W.A. APPROVAL

11/2/2017  
PLAN DATE

WZD-100-A

SHEET  
7 OF 11

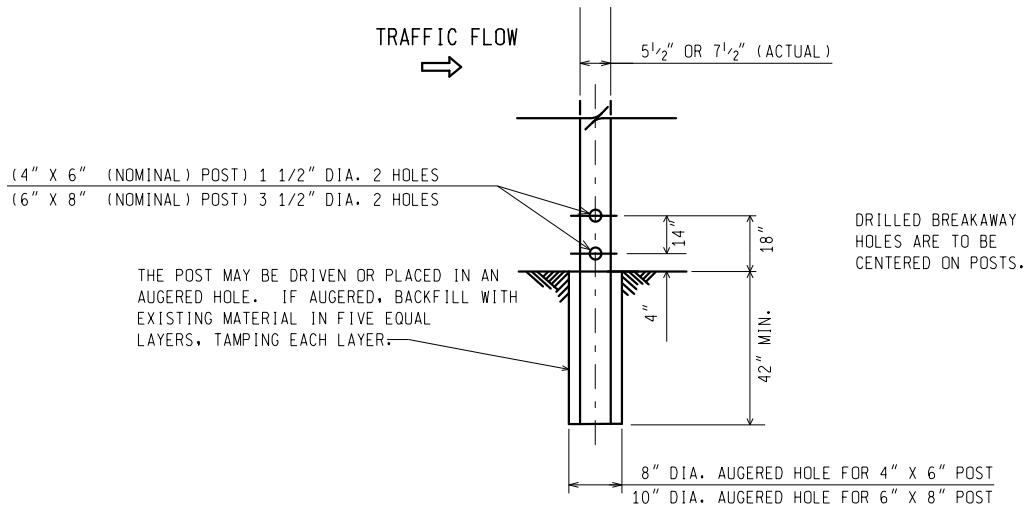

WOOD POST BREAKAWAY HOLES/  
 DIRECT EMBEDMENT DETAILS

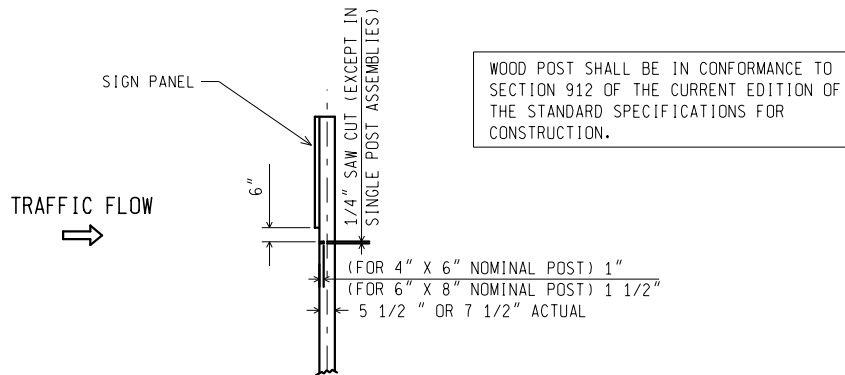

SAW CUT DETAIL  
 (MULTIPLE POST INSTALLATIONS)

WOOD POST DETAILS

NOT TO SCALE

MICHIGAN DEPARTMENT OF TRANSPORTATION  
 BUREAU OF DEVELOPMENT STANDARD PLAN

F.H.W.A. APPROVAL

11/2/2017  
 PLAN DATE

WZD-100-A

SHEET  
 8 OF 11



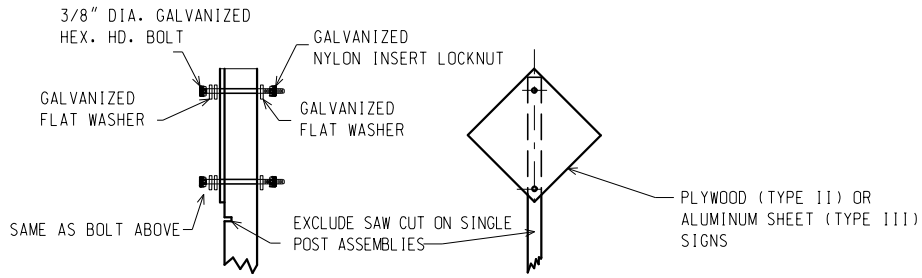

**TYPE II AND TYPE III SIGNS**

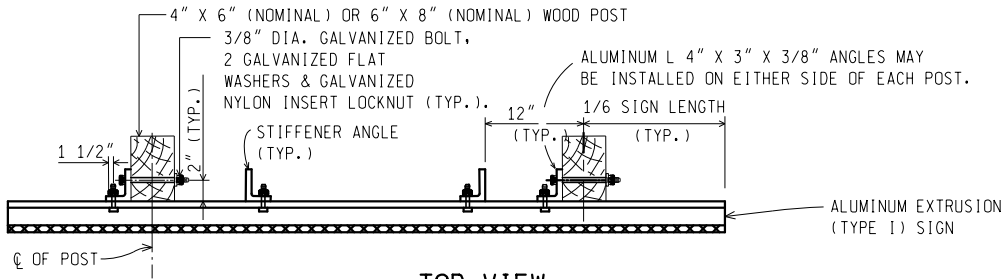

**TOP VIEW  
TYPE I SIGN**

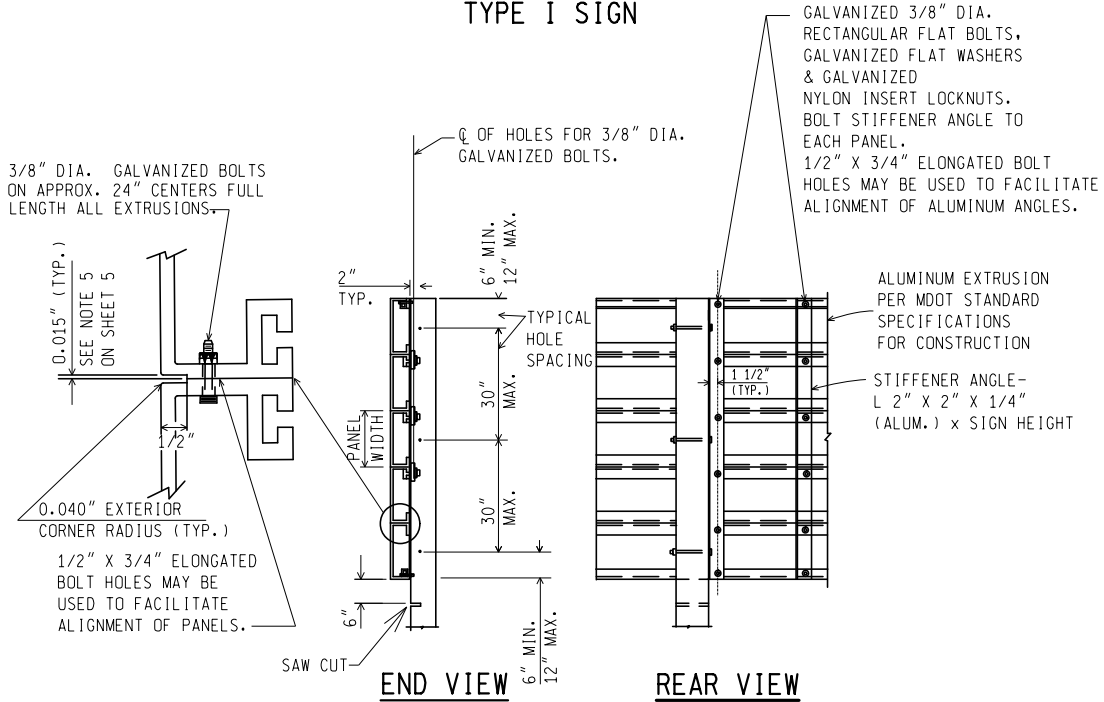

**TYPE I SIGN - ERECTION DETAILS**

**WOOD POST CONNECTIONS**

NOT TO SCALE

MICHIGAN DEPARTMENT OF TRANSPORTATION  
BUREAU OF DEVELOPMENT STANDARD PLAN

F.H.W.A. APPROVAL

11/2/2017  
PLAN DATE

WZD-100-A

SHEET  
9 OF 11

NOTE: THE ORIGINAL SIGNED COPY IS KEPT ON FILE AT THE MICHIGAN DEPARTMENT OF TRANSPORTATION.

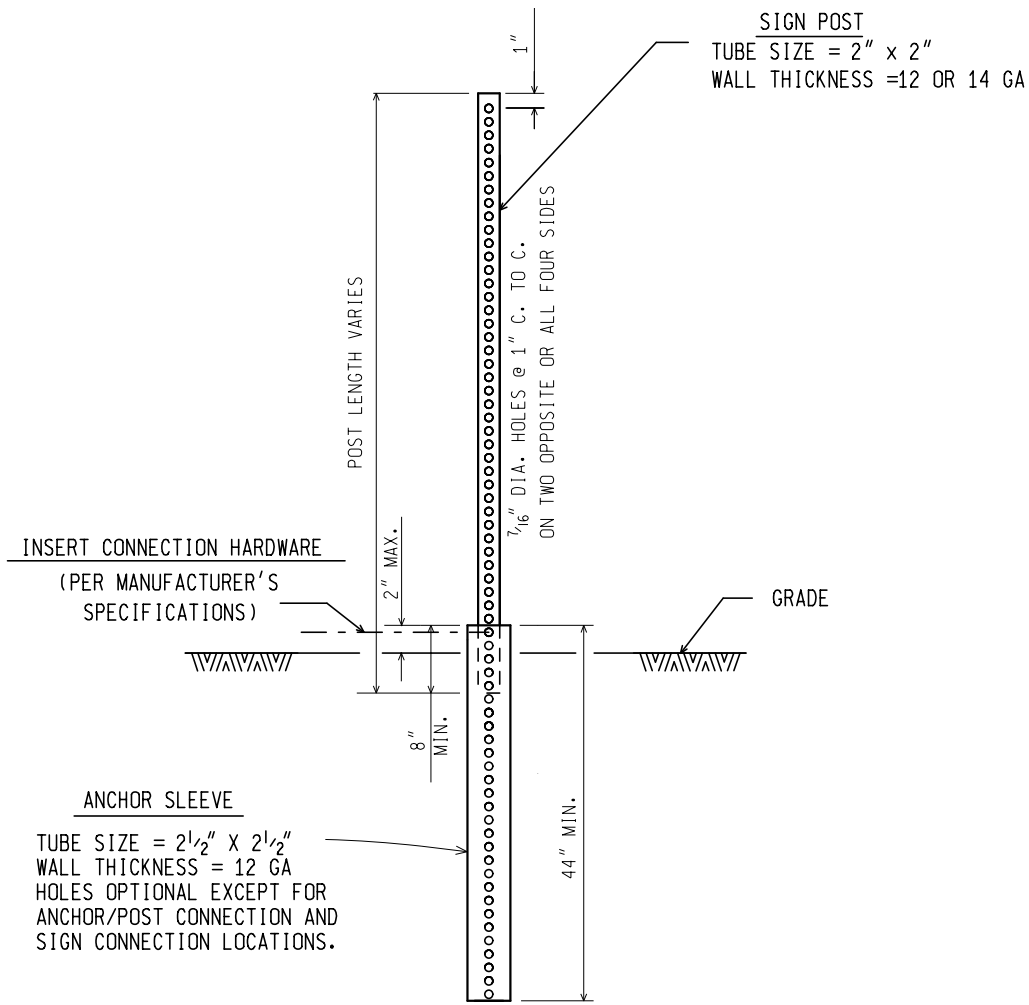

## SQUARE TUBULAR STEEL POST

NOT TO SCALE

MICHIGAN DEPARTMENT OF TRANSPORTATION  
BUREAU OF DEVELOPMENT STANDARD PLAN

F.H.W.A. APPROVAL

11/2/2017  
PLAN DATE

WZD-100-A

SHEET  
10 OF 11

NOTE: THE ORIGINAL SIGNED COPY IS KEPT ON FILE AT THE MICHIGAN DEPARTMENT OF TRANSPORTATION.

DS-154

GENERAL NOTES:

1. A MAXIMUM OF TWO POSTS WITHIN A 7 FOOT PATH IS PERMITTED.
2. ALL SIGN POSTS SHALL COMPLY WITH NCHRP 350.
3. ALL POSTS SHALL BE EMBEDDED A MINIMUM OF 42".
4. BRACING OF POST IS NOT PERMITTED.
5. SIGN SHALL BE LEVEL, AND UPRIGHT FOR THE DURATION OF INSTALLATION.
6. ERECT POSTS SO THE SIGN FACE AND SUPPORTS DO NOT VARY FROM PLUMB BY MORE THAN 3/16" IN 3'. PROVIDE A CENTER-TO-CENTER DISTANCE BETWEEN POSTS WITHIN 2 PERCENT OF PLAN DISTANCE.
7. NO MORE THAN ONE SPLICE PER POST, AS SHOWN, WILL BE PERMITTED.
8. POST TYPES SHALL NOT BE MIXED WITHIN A SIGN SUPPORT INSTALLATION.
9. NO VERTICAL JOINTS ARE PERMITTED IN SIGN. NO HORIZONTAL JOINTS THROUGH SIGN LEGEND OR SYMBOLS ARE PERMITTED IN SIGN
10. REMOVE SIGN POSTS AND/OR POST STUBS IN THEIR ENTIRETY WHEN NO LONGER REQUIRED.
11. ALL LABOR, MATERIALS, AND EQUIPMENT, INCLUDING TEMPORARY SUPPORTS REQUIRED TO INSTALL, MAINTAIN, RELOCATE, AND/OR REMOVE THE TEMPORARY SIGN, INCLUDING SUPPORTS, ARE CONSIDERED TO BE INCLUDED IN THE COST OF THE TEMPORARY SIGN.
12. SAW CUTS IN WOOD POSTS ARE TO BE PARALLEL TO THE BOTTOM OF THE SIGN.
13. POSTS SHALL NOT EXTEND MORE THAN 4" ABOVE TOP OF SIGN.
14. TEMPORARY WOOD SUPPORTS DO NOT REQUIRE PRESERVATIVE TREATMENT.

NOT TO SCALE

MICHIGAN DEPARTMENT OF TRANSPORTATION BUREAU OF DEVELOPMENT STANDARD PLAN	F.H.W.A. APPROVAL	11/2/2017 PLAN DATE	WZD-100-A	SHEET 11 OF 11
--	-------------------	------------------------	-----------	-------------------

NOTE: THE ORIGINAL SIGNED COPY IS KEPT ON FILE AT THE MICHIGAN DEPARTMENT OF TRANSPORTATION.

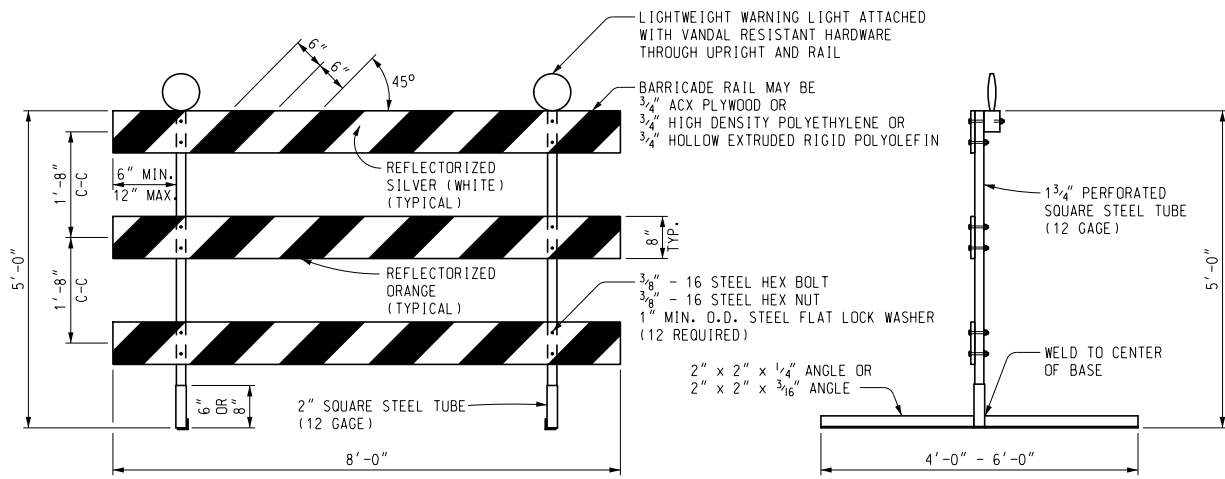

FRONT ELEVATION

SIDE VIEW

**PERFORATED SQUARE STEEL TUBE OPTION**

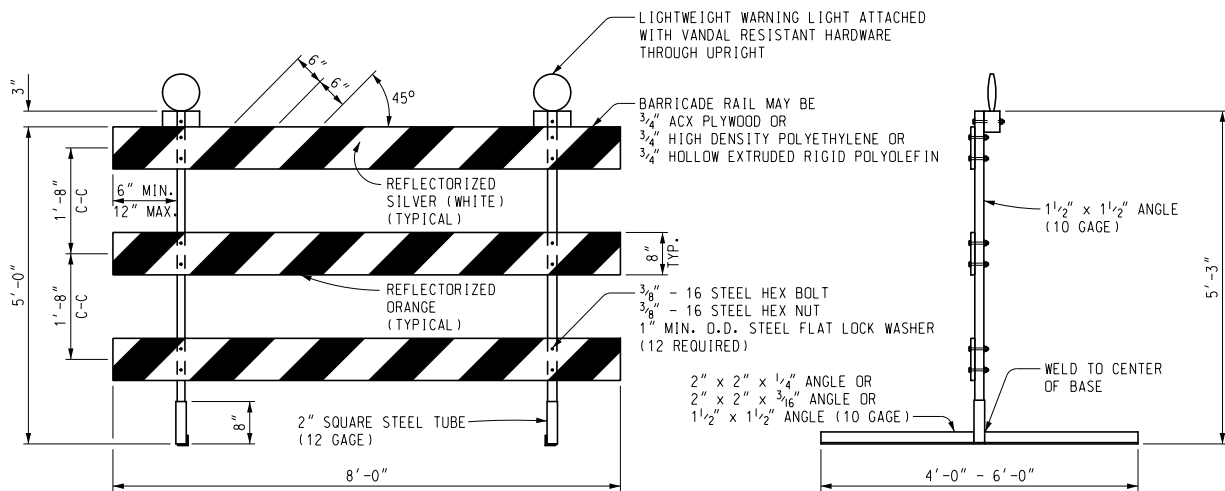

FRONT ELEVATION

SIDE VIEW

**ANGLE IRON OPTION**

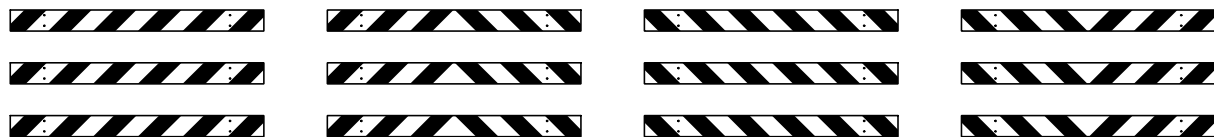

LEFT DIRECTIONAL

BI-DIRECTIONAL

RIGHT DIRECTIONAL

CLOSURES

**BARRICADE RAIL SHEETING OPTIONS  
TYPE III BARRICADES**

Other Type III Barricades meeting current NCHRP crash worthy criteria can be found on the FHWA Safety website at [http://safety.fhwa.dot.gov/roadway\\_dept/road\\_hardware/wzd.htm](http://safety.fhwa.dot.gov/roadway_dept/road_hardware/wzd.htm)

**MDOT**  
Michigan Department of Transportation

PREPARED BY  
OPERATIONS  
FIELD SERVICES

DRAWN BY: ECH

CHECKED BY: MWB

DEPARTMENT DIRECTOR  
Paul C. Ajegba

APPROVED BY: \_\_\_\_\_  
DIRECTOR, BUREAU OF FIELD SERVICES

APPROVED BY: \_\_\_\_\_  
(SPECIAL DETAIL)  
DIRECTOR, BUREAU OF HIGHWAY DEVELOPMENT

DS-156

MICHIGAN DEPARTMENT OF TRANSPORTATION  
BUREAU OF FIELD SERVICES SPECIAL DETAIL FOR

Temporary  
Traffic Control Devices

F.H.W.A. APPROVAL

6/16/22  
PLAN DATE

WZD-125-E

SHEET  
1 OF 3

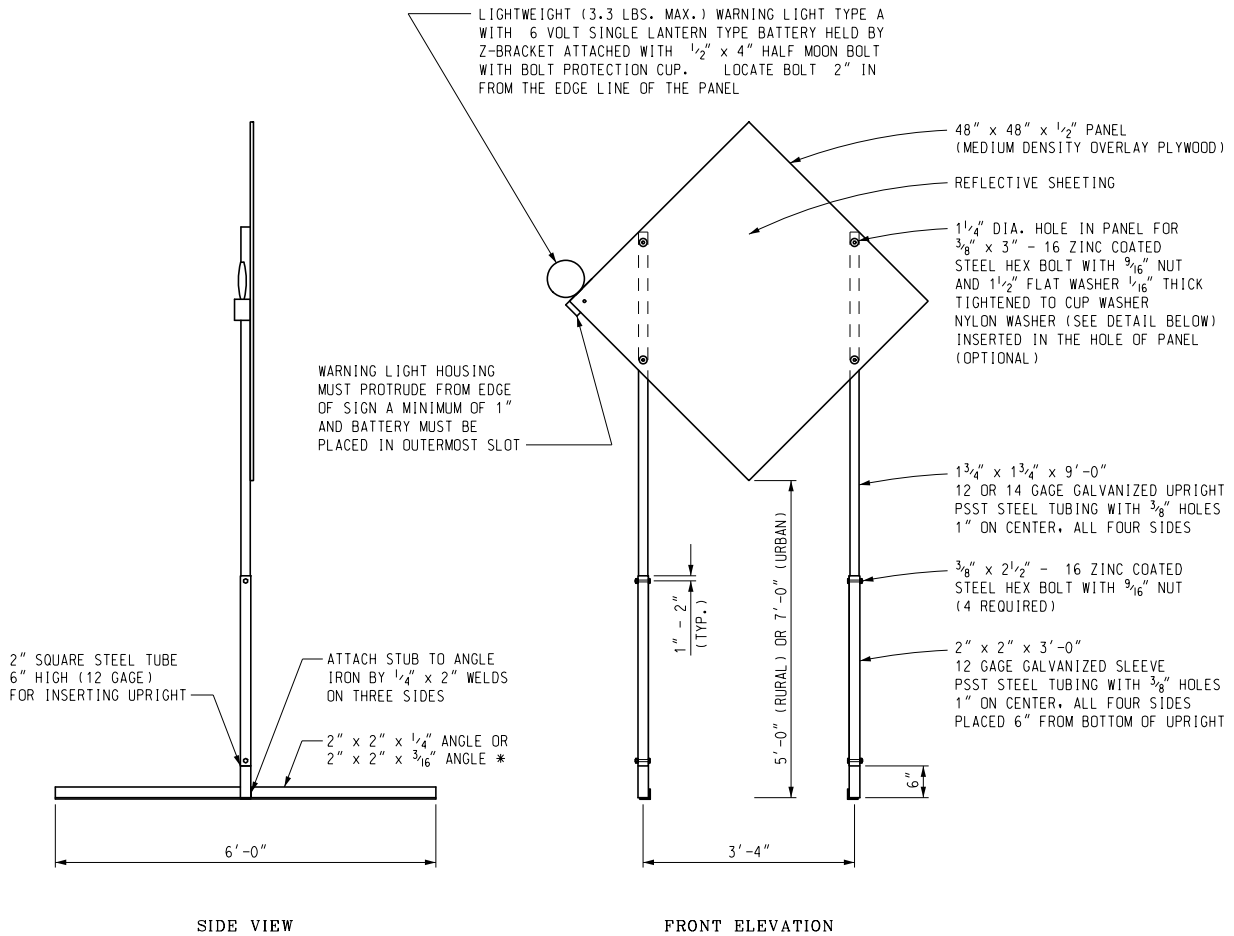

### TEMPORARY SIGN SUPPORT

(WARNING LIGHT PLACED ON SIDE CLOSEST TO TRAFFIC)

\* SIGN STAND IS BALLASTED WITH FOUR OR MORE 35 LB SANDBAGS. A MINIMUM OF ONE ON EACH END. UPRIGHTS SHALL NOT EXTEND ABOVE THE SIGN PANEL.

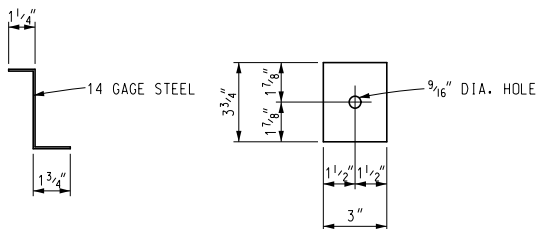

Z-BRACKET DETAIL

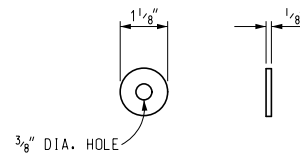

OPTIONAL NYLON WASHER

Other temporary sign supports meeting current NCHRP crash worthy criteria can be found on the FHWA Safety website at [http://safety.fhwa.dot.gov/roadway\\_dept/road\\_hardware/wzd.htm](http://safety.fhwa.dot.gov/roadway_dept/road_hardware/wzd.htm)

NOT TO SCALE

MICHIGAN DEPARTMENT OF TRANSPORTATION  
BUREAU OF FIELD SERVICES SPECIAL DETAIL

DS-157

SPECIAL DETAIL  
F.H.W.A. APPROVAL

6/16/22  
PLAN DATE

WZD-125-E

SHEET  
2 OF 3

NOTE: THE ORIGINAL SIGNED COPY IS KEPT ON FILE AT THE MICHIGAN DEPARTMENT OF TRANSPORTATION.

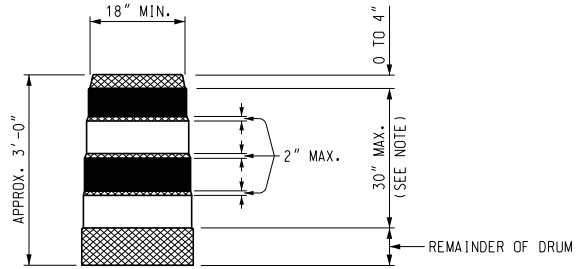

- REFLECTORIZED ORANGE
- REFLECTORIZED WHITE
- NON REFLECTORIZED ORANGE

NOTE:  
 DRUMS SHALL HAVE AT LEAST 4 HORIZONTAL REFLECTORIZED STRIPES (2 ORANGE AND 2 WHITE) OF 6" UNIFORM WIDTH, ALTERNATING IN COLOR WITH THE TOPMOST REFLECTORIZED STRIPE BEING ORANGE. NON REFLECTORIZED SPACES BETWEEN THE HORIZONTAL REFLECTORIZED ORANGE AND WHITE STRIPES SHALL BE ORANGE IN COLOR AND EQUAL IN WIDTH.

### PLASTIC DRUM

NOTES:

2" PERFORATED SQUARE STEEL TUBES MAY BE USED TO FABRICATE THE HORIZONTAL BASE OF THE TYPE III BARRICADE.

WARNING LIGHTS SHALL BE PLACED ACCORDING TO THE CURRENT STANDARD SPECIFICATIONS FOR CONSTRUCTION AND ALL OTHER PROVISIONS IN THE CONTRACT ON TYPE III BARRICADES.

SEE ROAD STANDARD PLANS R-113-SERIES FOR TEMPORARY CROSSOVERS FOR DIVIDED ROADWAY, AND R-126-SERIES FOR TYPICAL LOCATION AND SPACING OF PLASTIC DRUMS FOR PLACEMENT OF TEMPORARY CONCRETE BARRIER.

SIGNS, BARRICADES, AND PLASTIC DRUMS SHALL BE FACED WITH PRESSURE-SENSITIVE REFLECTIVE SHEETING ACCORDING TO THE CURRENT STANDARD SPECIFICATIONS FOR CONSTRUCTION.

SANDBAGS SHALL BE USED WHEN SUPPLEMENTAL WEIGHTS ARE REQUIRED TO ACHIEVE STABILITY OF THE BARRICADE. THE SANDBAGS SHALL BE PLACED SO THEY WILL NOT COVER OR OBSTRUCT ANY REFLECTIVE PORTION OF THE TRAFFIC CONTROL DEVICE.

NOT TO SCALE

MICHIGAN DEPARTMENT OF TRANSPORTATION  
 BUREAU OF FIELD SERVICES SPECIAL DETAIL

DS-158

(SPECIAL DETAIL)  
 F.H.W.A. APPROVAL

6/16/22  
 PLAN DATE

WZD-125-E

SHEET  
 3 OF 3

NOTE: THE ORIGINAL SIGNED COPY IS KEPT ON FILE AT THE MICHIGAN DEPARTMENT OF TRANSPORTATION.

DETAILED SPECIFICATION  
FOR  
**PROJECT SUPERVISION, MAX \$100,000**

AA:MGN  
WT:AJK:VCM:CGT

1 of 4

11/19/22

**a. Description.-** The Contractor shall provide supervision in accordance with Subsection 104.07 of the Michigan Department of Transportation 2020 Standard Specifications for Construction, the City of Ann Arbor Public Services Area Standard Specifications, and as described herein.

The Contractor shall designate a full-time Project Supervisor to act as the Contractor's agent/representative, and to be responsible for scheduling and coordination of all subcontractors, suppliers, other governmental agencies, and all public and private utility companies.

The Project Supervisor shall not be an active crew member of the Contractor, shall not be an active member or employee of any subcontractor's work force, and shall not perform general or specialized labor tasks. The Project Supervisor shall be a full-time employee of the General Contractor and shall have all needed authority to make binding decisions on behalf of the Contractor in all matters pertaining to performance and execution of the work of the project.

The Project Supervisor shall work exclusively on this project, and shall put forth his/her full effort into the organization and coordination of the work of this project.

One week prior to the pre-construction meeting, the Contractor shall designate a proposed Project Supervisor by name, and shall furnish the Engineer with a current, thorough, detailed summary of the proposed Project Supervisor's work history, outlining all previous supervisory experience on projects of a similar size and nature. The detailed work history shall include personal and professional references (names and phone numbers) of persons (previous owners or agents) who can attest to the qualifications and work history of the proposed Project Supervisor. Proposed candidates for Project Supervisor shall have a demonstrated ability to work harmoniously with the Engineer, the City, the public, subcontractors, and all other parties typically involved with work of this nature. The Engineer will have the authority to reject a proposed Project Supervisor whom he/she considers unqualified.

The Project Supervisor shall be available 24 hours-per-day to provide proper supervision, coordination and scheduling of the project for the duration of the Contract. The Contractor shall furnish the City with telephone numbers of the Project Supervisor in order to provide 24 hour-per-day access during business and non-business hours, including weekends and holidays.

The Project Supervisor shall be equipped by the Contractor with a "smart" mobile telephone with "data" and "text" capabilities to provide the City with 24 hour-per-day

DETAILED SPECIFICATION  
FOR  
**PROJECT SUPERVISION, MAX \$100,000**

AA:MGN  
WT:AJK:VCM:CGT

2 of 4

11/19/22

access to him/her during daily construction activities, during transit to and from the construction site, and during all non-business hours including weekends and holidays.

The Project Supervisor shall be equipped with assistants as necessary to provide project supervision as specified herein, and in accordance with the Contract.

**b. Duties and Responsibilities.-** The Project Supervisor shall work harmoniously with the Engineer, the City, the public, subcontractors, and all other parties typically involved with work of this nature.

The Project Supervisor shall have a thorough, detailed understanding and working knowledge of all construction practices and methods specified elsewhere herein, as well as the handling, placement, testing and inspection of aggregates, aggregate products, bituminous concrete, portland cement concrete materials, and other such materials and products related to the work of this project.

The Project Supervisor shall be responsible for all of the work of all of the Contractor's, subcontractors' and suppliers' work forces.

The Project Supervisor shall be responsible for proper and adequate maintenance (emissions, safety, and general operation) of all of the Contractor's, subcontractors' and suppliers' equipment and vehicles. The Project Supervisor shall make all needed diligent and good-faith efforts to ensure that all equipment utilized in the performance of the work is properly maintained, safe, and complies with all legal and environmental requirements of the work as set forth in Section 107.15 of the 2020 MDOT Standard Specifications.

The Project Supervisor shall be responsible for the legal, proper and safe parking/storage of all of the Contractor's, subcontractors' and suppliers' equipment, work vehicles, and employee's vehicles.

The Project Supervisor shall schedule and coordinate the work of all parties involved in the project, including utility companies, testing agencies, governmental agencies, all City departments (such as Utilities and Transportation), and City inspectors.

The Project Supervisor shall coordinate and schedule the work of any independent survey crews that may be retained by the Engineer or City to witness and reset existing and new geographic/benchmark monuments. Failure to have existing monuments witnessed and reset may result in delays to the Contractor's work. Costs for such delays will be the Contractor's sole responsibility. The Project Supervisor shall also schedule and complete all needed survey request forms that are needed in order to



DETAILED SPECIFICATION  
FOR  
**PROJECT SUPERVISION, MAX \$100,000**

AA:MGN  
WT:AJK:VCM:CGT

3 of 4

11/19/22

schedule the services of survey personnel to properly layout all elements of the project work in accordance with the City of Ann Arbor Public Services Area Standard Specifications and the Michigan Department of Transportation 2020 Standard Specifications for Construction.

The Project Supervisor shall coordinate and schedule inspection performed by the City and Consultants (including material testing firms) in a timely manner, to assure proper and timely testing and inspection of the work.

The Project Supervisor shall submit to the Engineer, an updated, detailed schedule of the proposed work on a weekly basis, and an update of all proposed changes on a daily basis.

The Project Supervisor and all subcontractors shall attend a weekly progress meeting chaired by the Engineer to discuss the work. Upon the completion of each meeting, the Engineer shall prepare and distribute, to all present, a written summary of the meeting's minutes. Those in attendance shall review the minutes and, if necessary, comment on any deficiencies or errors prior to or at the next scheduled progress meeting.

**c. Additional Performance Requirements.-** If, in the sole opinion of the Engineer, the Project Supervisor is not adequately performing the duties as outlined in this Detailed Specification, the following system of notices will be given to the contractor with the associated penalties:

First Notice – A warning will be issued in writing to the Contractor detailing the deficiencies in the Project Supervision. The Contractor must respond within 7 calendar days in writing with a plan to correct the stated deficiencies. Failure to respond within 7 calendar days will result in the issuing of a second notice.

Second Notice – A second warning will be issued in writing to the contractor further detailing the deficiencies in the Project Supervision. A deduction of 10%, or \$10,000, whichever is greater, will be made from the original Project Supervision contract amount. The Contractor must respond within 7 calendar days in writing with a plan to correct the stated deficiencies. Failure to respond within 7 calendar days will result in the issuing of a third notice. At this time, the Engineer reserves the right to meet with personnel with the necessary authority within the Contractor's organization to discuss the deficiencies in the Project Supervision.

DETAILED SPECIFICATION  
FOR  
**PROJECT SUPERVISION, MAX \$100,000**

AA:MGN  
WT:AJK:VCM:CGT

4 of 4

11/19/22

Third Notice – A third notice will be issued in writing to the Contractor further detailing the deficiencies in the Project Supervision. An additional deduction of 25%, or \$25,000, whichever is greater, will be made from the original Project Supervision contract amount, and the Project Supervisor shall be removed from the project, and replaced immediately with another individual to be approved by the Engineer.

Should, in the sole opinion of the Engineer, the Project Supervisor fail to perform his/her duties and responsibilities as described herein to such a degree that the successful completion of the project is put in jeopardy, the above system of notices may be foregone, and the Contractor shall immediately replace the Project Supervisor upon receipt of written notice. Failure to provide adequate project supervision, as determined by the Engineer, shall be considered basis for the Engineer to suspend work without extension of contract time or additional compensation.

If the original Project Supervision contract amount is insufficient to cover said deductions, the Project Supervision contract amount will be reduced to zero and a contract modification will be written to assess a penalty to cover the difference between the Project Supervision contract amount and the total amount of the deduction(s). It is fully expected however that the Project Supervision contract amount will be sufficient to cover any deductions.

**d. Measurement and Payment.-** The completed work as measured for this item of work will be paid for at the Contract Unit Price for the following Contract (Pay) Item:

<u>Contract Item (Pay Item)</u>	<u>Pay Unit</u>
Project Supervision, Max \$100,000 .....	Lump Sum

The unit price for this item of work shall include all labor, material, and equipment costs to perform all the work specified in the Standard Specifications and as modified by this Detailed Specification.

Payment for this work will be made with each progress payment, on a pro rata basis, based on the percentage of construction completed. When all of the work of this Contract has been completed, the measurement of this item shall be 1.0 times the Lump Sum bid amount, minus any deductions incurred for inadequate performance as described herein. This amount will not be increased for any reason, including extensions of time, extras, adjustments and/or additional work.

DETAILED SPECIFICATION  
FOR  
**TEMPORARY PEDESTRIAN BARRIER WITH FENCE**

WT:VCM

1 of 2

11/20/22

**a. Description.** This work consists of furnishing, installing, maintaining, relocating, and removing a temporary pedestrian barrier with fence as identified in the proposal or on the plans. Temporary pedestrian barrier with fence is used to positively protect and separate non-motorized traffic from motorized traffic in locations where the posted speed limit is 30 miles per hour (mph) or less. In addition, temporary pedestrian barrier with fence can be used to provide separation from the work area outside the roadway, and can also be used to delineate a non-motorized facility in accordance with the *MMUTCD* in an ADA compliant manner. Temporary pedestrian barrier with fence will be replaced as directed by the Engineer.

**b. Materials.** Provide materials to construct a temporary pedestrian barrier with fence in accordance with the contract, the *MMUTCD*, and the following requirements:

1. Provide a base section of sufficient weight that when ballast is installed (if applicable), the section cannot be moved without mechanical means. The base section must provide a continuous detectable edge, beginning no more than 2 inches above the surface of the non-motorized facility, and extending to a minimum of 8 inches above the surface. The base section must also include design features that allows a 6-foot tall chain link fence to be securely attached to the top of the section. The face of the barrier section in contact with pedestrians and non-motorized traffic must have a smooth continuous top edge to allow hand-trailing. The base may be constructed from the following materials:

A. Temporary concrete barrier and connection hardware in accordance with subsection 812.03 of the Standard Specifications for Construction.

B. A lightweight, recyclable, linear low density, polyethylene plastic shell, with ultra violet (UV) stabilizers and anti-oxidants, designed to accept water ballast. Ensure sections are either white or safety orange and alternate in color.

2. Provide 11 gauge zinc-coated steel or aluminum-coated steel in accordance with subsection 907.04.A of the Standard Specifications for Construction. This chain-link fence should be 6 feet tall and include appropriate posts and hardware to connect to the barrier sections, and connect to form a continuous fence with no breaks along the installation.

3. If installed in the presence of motor vehicle traffic, the normal posted speed limit (prior to construction) must be 30 mph or less, the barrier installation must meet *National Cooperative Highway Research Program Report 350 (NCHRP 350) Test Level 1 (TL-1)* or *Manual for Assessing Safety Hardware (MASH) Test Level 1 (TL-1)* requirements. If required, provide a temporary barrier ending in accordance with

subsection 812.03.D.10 of the Standard Specifications for Construction (paid for separately).

**c. Construction.** Install the temporary pedestrian barrier with fence in accordance with the manufacturer’s requirements, the plans, as per the direction of the Engineer, and the following:

1. Place sections at the locations shown on the plans or as directed by the Engineer. Securely connect all barrier sections in accordance with the manufacturer’s specifications. If water filled barrier sections are used, alternate colors along the installation to increase conspicuity. Install fence sections such that no gaps are present that may allow pedestrians into closed areas or into an active traffic lane.

2. If required, install water ballast to the manufacturer recommended level. If water filled barrier sections are used during freezing temperatures, install an environmentally safe anti-freezing agent to ensure liquid does not freeze per the manufacturer’s recommendations. Ensure frozen water-filled barrier sections are replaced immediately at no cost to the Department. When the barrier sections are removed, ensure any anti-freezing agents are securely collected and properly disposed of.

3. Install the temporary barrier ending if required.

4. Ensure that the barrier installation meets *MMUTCD*, and *NCHRP 350, TL-1 or MASH, TL-1* requirements at all times when in use. Routinely inspect ballast levels (if applicable) and refill or replace barrier sections if needed.

**d. Measurement and Payment.** The completed work, as described, will be measured and paid for at the contract unit price using the following pay item:

<b>Pay Item</b>	<b>Pay Unit</b>
Pedestrian Barrier With Fence, Temp .....	Foot

**Pedestrian Barrier With Fence, Temp** includes all labor, equipment, and materials to furnish, install, maintain, relocate, and remove a temporary pedestrian barrier with fence, at the locations shown on the plans.

DETAILED SPECIFICATION  
FOR  
**FLOWABLE FILL**

WT:VCM

1 of 2

01/17/19

**a. Description.** This work consists of furnishing and placing flowable fill as backfill material at miscellaneous locations as shown on the plans, and as directed by the Engineer.

**b. Materials.** Provide flowable fill material, as directed by the Engineer, meeting one the following mixes:

1. Portland cement, fly ash, and water.
2. Portland cement, granular material, fly ash, and water.
3. Fly ash, granular material, and water.

Provide materials in accordance with the following requirements:

		<sup>(3)</sup> <u>Specific Gravity</u>
Portland Cement	MDOT Section 901	3.15
Fly Ash	<sup>(1)</sup> ASTM C 618(I)	2.40
Granular Material, CI II	<sup>(2)</sup> MDOT Section 902	2.60
Water	MDOT Section 911	1.00

Note: Reference to MDOT relates to applicable sections of the Michigan Department of Transportation 2020 Standard Specifications for Construction.

<sup>(1)</sup>Except there is no limit on the loss of ignition.

<sup>(2)</sup>Except that 100% shall pass 3/4-inch sieve.

<sup>(3)</sup>Specific gravity values used for mix proportions given. If material used differs from these values make appropriate adjustments as required to achieve an acceptable mixture.

Acceptable mixtures for flowable fill are as follows:

1. FF Mix Number One  
Cement Stabilized Fly Ash Mixture (Class F Fly Ash)

Portland Cement	100 lbs/cyd
Fly Ash (Class F)	2000 lbs/cyd
Water	Sufficient amounts to produce the desired flowability (approx. 80 gal/cyd)

2. FF Mix Number Two  
Controlled Density Fill Mixture (Class F Fly Ash)

Portland Cement	50 lbs/cyd
Fly Ash (Class F)	500 lbs/cyd
Granular Material	2600 lbs/cyd
Water	Sufficient amounts to produce the desired flowability (approx. 50 gal/cyd)

3. FF Mix Number Three  
Controlled Density Fill Mixture (Class C Fly Ash)

Fly Ash (Class C)	300 lbs/cyd
Granular Material	2600 lbs/cyd
Water	Sufficient amounts to produce the desired flowability (approx. 50 gal/cyd)

**c. Construction.** Furnish and place flowable fill at miscellaneous locations as shown on the plans, and as directed by the Engineer.

All flowable fill, after setting, is intended to be removable by conventional mechanical excavation methods.

**d. Measurement and Payment.** The completed work, as described, will be measured and paid for at the contract unit prices for the following pay items:

<u>Pay Item</u>	<u>Pay Unit</u>
Flowable Fill (Backfill).....	Cubic Yard

The unit price for this item of work shall include all labor, material, and equipment costs to perform all the work specified by this Detailed Specification.

Flowable fill used at the Contractor's option will not be paid for separately but shall be included either in the bid price(s) for the associated work item(s), or in the bid price for the item of work "General Conditions, Max \$ \_\_\_\_".

DETAILED SPECIFICATION  
FOR  
**NO PARKING SIGNS**

WT:VCM

1 of 2

11/17/22

**a. Description.** This work shall consist of installing, maintaining and removing of "No Parking" signs and posts as outlined herein and as referenced on the plans. "No Parking" signs shall be installed in accordance with the section 812 of the Michigan Department of Transportation (MDOT) 2020 Standard Specifications for Construction Standard Specifications and the 2011 Michigan Manual of Uniform Traffic Control Devices (MMUTCD).

**b. Materials.** The City will furnish "No Parking" signs to the Contractor at no cost. The Contractor shall furnish the sign support and mounting hardware materials, which materials shall be in accordance with those specified in section 919 of the MDOT 2020 Standard Specifications for Construction.

**c. Construction.** Prior to the commencement of any construction activity, the Contractor shall place "No Parking" signs as directed by the Engineer. The Contractor shall obtain a permit for "Temporary Permission of Reserve Parking Lane for Work Related Purposes" from the City's Project Management Services Unit. This permit shall be obtained a minimum of 5 business days prior to the posting of "No Parking" signs.

The Contractor shall securely bolt the signs to the sign supports as directed by the Engineer. The Contractor shall imbed the sign supports at least two feet into the ground, and there shall be a minimum of six feet and maximum of seven feet of clearance maintained between the bottom of the sign and the ground. The signs are to be placed at intervals no more than 75 feet, and as necessary to eliminate parking in the construction area.

The installation of "No Parking" signs shall be in accordance with the permit. "No Parking" signs shall be installed by the Contractor, as directed by the Engineer, at least 48 hours prior to the proposed start-of-work/enforcement date. "No Parking" signs shall be covered by the Contractor, thereby allowing on-street parking, until between 48 and 24 hours prior to the start of the work. "No Parking" signs shall be covered by the Contractor whenever there is no work being performed for a period of time longer than 72 hours. "No Parking" signs shall be returned to the City upon the completion of work. The cost of unreturned signs will be back charged to the Contractor.

**d. Measurement and Payment.** The completed work, as described, will be measured and paid for at the contract unit price for the following pay item:

<u>Pay Item</u>	<u>Pay Unit</u>
No Parking Sign .....	Each

The item **No Parking Sign** will be measured as the maximum number of signs installed on the project at any one time. The unit price includes the removal and return of "No Parking" signs to the City upon completion of the project. The Contractor shall be back charged for the replacement costs for damaged or unreturned signs.



CITY OF ANN ARBOR  
SPECIAL PROVISION  
FOR  
**AUDIBLE MESSAGE DEVICES**

AA:JKA

1 of 3

1/17/2020

**a. Description.-** This work shall consist of furnishing and installing temporary audible message devices to be used in Temporary Pedestrian Alternate Routes (TPAR) for pedestrians with visual impairments in compliance with the latest version of the Michigan Manual on Uniform Traffic Control Devices (MMUTCD) and the Public Right-of-Way Accessibility Guidelines (PROWAG), published in November 2005. All work shall be in accordance with the Special Provision for "Maintenance of Traffic" and as indicated on the plans, and as modified herein.

**b. Categories.-** Audible message devices (AMDs) will have two categories:

1. AMDs without a pushbutton
  - These devices will operate based on a proximity sensor; the audible message content will be given when the sensor is activated.
2. AMDs with a pushbutton and locator tone
  - These devices will have the capability of utilizing a locator tone for pedestrians with visual impairments to locate the pushbutton on the AMD. The pushbutton on the AMD will activate the audible message content. The AMD may continuously sound the locator tone, or the locator tone may be activated with a proximity sensor.

**c. Criteria.-** Following are the necessary criteria for all types of AMDs to be on the APL:

- Compliant with the latest version of the Michigan Manual on Uniform Traffic Control Devices (MMUTCD) and the Public Right-of-Way Accessibility Guidelines (PROWAG), published in November 2005.
- Be weatherproof and fully operational between -20° F to +130° F and in a humidity range of 0-100% non-condensing.
- Be able to be battery operated.
- Proximity sensor shall be able to detect pedestrians from 15 feet away.
- The ability to verbalize a custom voice messages for a minimum of 60 seconds.
- Volume requirements
  - Volume measured at 3 feet from the AMD shall be 2 dB minimum and 5 dB maximum above ambient noise level in standard operations and shall be responsive to ambient noise level changes.
  - The ability to maximize volume at 100 dBA

Following are the additional necessary criteria for AMDs with pushbuttons and locator tones:

- The device shall be designed such that the pushbutton is within the Reach Ranges identified in PROWAG when the device is placed on level ground. In addition, the pushbutton shall be placed approximately at 42 inches (but no more than 48 inches) from the bottom of the device.
- Pushbuttons shall incorporate a locator tone at the pushbutton. Pushbutton locator tone volume measured at 3.0 feet from the pushbutton shall be 2 dB minimum and 5 dB maximum above ambient noise level and shall be responsive to ambient noise level changes. The duration of the locator tone shall be 0.15 seconds maximum and shall

repeat at intervals of one second. The locator tone may be activated by a proximity sensor.

**c. Materials.-** Approved Temporary Audible Message Devices are as follows:

- Model 400ADA audible Device, manufactured by Empco-Lite, 1675 Shanahan Drive, South Elgin, IL USA 60177.
  - The 400ADA is an audible information device that can be mounted on various safety devices like the ADA Wall, 42" Cones, and the Safety Wall. Or it can just be a stand-alone device.
  - Easily program your message with built-in microphone and speaker.
  - Record up to a 60 second message.
  - Customize message for each location. See "Messages for Audible Information Devices" for message guidelines and helpful information.
  - When routes are blocked (especially mid-block closings), there are alternate crossings or alternate routes that are not continuous, these units provide positive guidance for the visually impaired by providing needed audible information. See 2009 MUTCD Section 6D.01 E, Section 6D.02, Section 6F.14, Section 6F.16 and notes on Figure 6H-28 and Figure 6H-29 (see PDF).
  - Unit can be mounted on a standard barricade light housing utilizing two 6V spring terminal batteries or can be a self contained unit operating on four D-Cell batteries.
  - Unit is triggered by motion detector when pedestrians get within 15 feet of the unit.
  
- SpeakMaster 500, manufactured by MDI Worldwide, 38271 W Twelve Mile Road, Farmington Hills, MI 48331.
  - The ADA SpeakMaster™ is an audible warning device that alerts pedestrians of a sidewalk closure ahead and provides navigation instructions Rugged design, simple to install and programmable through Bluetooth connectivity, the 9" DFB sign promotes safety where ever they're installed.
  - The all aluminum ADA SpeakMaster stands 5.5 feet high, is completely weather resistant, and ADA compliant. The two-sided frame at the top has snap-open side rails to easily change custom signs. The frame can rotate 360° to accommodate the different requirements of multiple urban areas. The unit is powered by an extended-life battery stored in a key-locked compartment in the base, and the base can be weighted for added stability and security. The electronics are housed in the upright, also in a key-locked compartment, and messages can be programmed on site, by cell phone, or computer. The base tilts and rolls on hidden wheels.
  - The ADA SpeakMaster is positioned approximately 100 feet before the actual sidewalk closure. As the pedestrian approaches, he hears a unique locator tone, which the visually impaired have been taught to recognize.

The tone is either on continuously or is activated by an optional motion sensor and indicates that there is more information. The pedestrian locates the push button and activates the voice module to hear navigation instructions. He can then safely pass through the temporary pedestrian accessible route.

**d. Construction Methods.-** Installer’s Qualifications: Engage an experienced Installer who has successfully completed AMD installations similar in material, design, and extent to that indicated for this Project.

The contractor shall follow manufacturer specifications for installation, except where they conflict with MMUTCD or other project requirements.

**e. Measurement and Payment.-** The completed work as measured for the following pay items will be paid for at the contract unit prices for the following contract items (pay items):

<u><b>Contract Item (Pay Item)</b></u>	<u><b>Pay Unit</b></u>
Temporary Audible Message Device.....	Each

The unit price for this item shall include all labor, material, and equipment costs required to complete the work.

DETAILED SPECIFICATION  
FOR  
**TEMPORARY WATER MAIN LINE STOP**

AA:MGN

1 of 7

11/20/22

**a. Description.-** The Contractor shall furnish all materials, labor and equipment to properly install and set water main line stops into the existing Ductile Iron Main(s) at the locations as shown on the plans and as directed by the Engineer. All work shall be performed in accordance with the requirements as detailed herein.

The existing mains, upstream and downstream of the proposed line stop(s) cannot be shut down or taken out of service. To ensure that the entire operation shall be accomplished without interruption of service or flow, the installation shall be accomplished by Contractor personnel skilled and experienced in the procedures specific to line stops of the required size(s).

The work shall include, but not be limited to; pavement saw-cutting; excavation and disposal of excavated material; the furnishing, installation, and removal of sheeting and/or shoring where needed; the furnishing, placement and compaction of approved bedding and backfill materials; furnishing and placing suitable, clean, gravel to create a stable working surface at the bottom of the excavation; de-watering; pipe cleaning, measuring, and performing all advance work necessary to prepare for the performance of the line stop; nighttime lighting as required; the removal of all materials and equipment associated with the work when no longer needed; and, any other items needed to complete the work as detailed on the plans and as specified herein.

**b. Materials.-** Bedding and backfill for areas contained within a segment of water main designated as Trench Detail I (under roadbed), Modified, shall be Granular Material, Class II, meeting the requirements of Section 902. For work within a segment of water main designated as Trench Detail V (outside of the 1:1 influence line of roadbed or curb and gutter), Modified, Granular Material, Class II and Engineer approved native material, placed in accordance with the trench details, shall be used.

The Contractor shall submit to the Engineer two (2) sets of drawings, furnished by manufacturers, fully and distinctly illustrated and describing the Line Stop fittings proposed to be furnished. Work shall not commence until such time as the drawings have been reviewed and accepted by the Engineer.

Line Stop Fittings shall be full encirclement, pressure retention type split tee. It shall consist of two steel weldments; an upper line stop flange saddle plate and a lower saddle plate. These two saddle plates shall be contiguous.

Line Stop Flange: The outlet of each fitting shall be machined from a 150 lb. forged

DETAILED SPECIFICATION  
FOR  
**TEMPORARY WATER MAIN LINE STOP**

AA:MGN

2 of 7

11/20/22

steel flange (ASTM A181 or A105) or from pressure vessel quality steel plate (ASTM A285, Grade C); flat faced and drilled per ANSI B16.5). Suitable independently operated locking devices shall be provided in the periphery of the flange to secure the completion plug.

Line stop Nozzle: The nozzle, which lies between the saddle and the flange shall be fabricated from steel pipe (ASTM A234). After welding and stress relief, the nozzle shall be accurately bored as follows to accommodate the Line stop plugging head:

- a) Machine an internal circular shoulder to seal against the circumferential gasket carried on the plugging head.

Completion Plug: The completion plug shall be machined from a stress relieved carbon steel weldment. It shall contain two (2) circumferential grooves: one to receive the locking devices from the Line stop flange, and the second to contain a compressible "O" ring to seal pressure tight against the bore of the flange.

Blind Flange: Each Line stop fitting shall be closed with a blind flange. Facing and drilling of the blind flange shall be compatible with that of the Line stop flange. Minimum blind flange thickness shall be that of AWWA Spec. 207, Class D.

Saddle Alignment Marking: Each saddle-half shall be matched and marked with serial numbers, to insure proper alignment in the field.

Fasteners: All bolts, studs, and nuts used on Line stop, drain/equalization fittings, blind flange, and other elements that shall remain upon completion of the work shall be stainless steel and meet the requirements of ASTM F 593.

General: Manufacturer will exercise extreme care to insure that weldments are of adequate strength, properly shaped, securely reinforced, and free from distortion that could stress the ductile iron main during installation, pressure tapping, or Line stopping operations. All steel shall meet the requirements of ASTM A36, as a minimum. All weldments shall be braced and stress relieved.

Gaskets: Shall be molded from elastomer compounds that resist compression setting and are compatible with water in the 32 to 140 deg. F temperature range.

Upper Line stop Flange Saddle: Shall consist of a saddle plate, a Line stop flange, and

DETAILED SPECIFICATION  
FOR  
**TEMPORARY WATER MAIN LINE STOP**

AA:MGN

3 of 7

11/20/22

a Line Stop nozzle. The interior of the saddle plate, adjacent to and concentric with the O.D. of the nozzle, shall be grooved to retain a gasket which shall seal the saddle plate to the exterior of the ductile iron main. This gasket shall constitute the only seal between the main and the fitting. The flange saddle shall also meet the following requirements:

- a) Saddle plate shall be of a minimum of 0.375" in thickness. It shall be shaped to be concentric to the outside of the ductile iron main. The smallest I.D. of the saddle and its interior rings shall exceed the O.D. of the main by a minimum of 0.250" to allow for ovality of the main;
- b) Line stop nozzle of 0.375" min. wall thickness shall be securely welded to the saddle plate;
- c) The Line Stop flange shall be securely welded to the nozzle. After welding, the assembly shall be braced, stress relieved, and bored to receive the completion plug and the circumferential gasket of the Line Stop machine plugging head; and,
- d) Bolt, nut of stud, nut, and washer assemblies shall be furnished to draw the upper and lower saddles together for sealing. Bolting brackets shall be gusseted.

Lower Saddle Plate: Saddle plate shall be of a minimum 0.375" thickness and shall be shaped to be concentric to the outside brackets shall match upper half.

**c. Equipment.-** The equipment shall consist of a cylindrical plugging head that contains a flat, expandable elastomer sealing element. The plugging head shall be advanced into and retracted from the main by means of a linear actuator. When retracted, the plugging head and carrier are housed in an adapter, bolted pressure tight between the tapping valve and the actuator.

Sealing Element: The element shall be monolithically molded from a suitable polyurethane compound. The element shall be flat in a plane perpendicular to the flow in the main. Minimum thickness of the element shall be 4". The bottom of the element shall be semi-circular to conform to the bore of the main.

Drilling equipment: Shall be in good working condition, equipped with power drive to insure smooth cutting, and to minimize shock and vibration. Cutting equipment shall be carbide tipped and capable of being replaced without removal from the jobsite.

Plugging Head: The diameter of the cylindrical plugging head shall be slightly smaller than the bore of the Line Stop nozzle. The plugging head shall have a suitable

DETAILED SPECIFICATION  
FOR  
**TEMPORARY WATER MAIN LINE STOP**

AA:MGN

4 of 7

11/20/22

circumferential gasket to seal against the shoulder in the Line stop nozzle. This gasket shall also seal against the sealing element to prevent bypass flow around the Line stop.

Deposits in Bore of Main: The semi-cylindrical bottom of the plugging head shall be designed to break and dislodge tuberculation and other deposits in the bore of the main which might interfere with a satisfactory Line stop.

**d. Method of Construction.-** Installation of proposed line stops mains will require work in close proximity to existing utilities. This must be taken into consideration when the contractor determines the required trench safety requirements. All excavation shall conform to MIOSHA Standards; the Contractor is solely responsible for determining all excavation and trench safety requirements.

If necessary, The City will reduce the pressure to 100 psig or less for the duration of the installations. The entire operation of installing the line stop shall be accomplished without reduction of water pressure in the main(s) below 100 psig. It shall be the responsibility of the Contractor to verify pressure prior to commencing the installation.

Preliminary Field Inspection of Water Main:

Dimensional, specification, and other data regarding the existing mains have been taken from existing records. This information may be inaccurate, out of date, and/or inadequate. The data have not been verified by field inspections. Further, the water main consists of ductile iron pipe which may contain dimensional and structural flaws. In addition, the Contractor shall anticipate that exterior main conditions, bells, service connections, or presence of adjoining utilities may require relocation of proposed line stop. Prior to proceeding with the installation of any line stop, it is necessary to know the exact main outside diameter of the water main, if it has any ovality, and the internal diameter of the pipe before line stop fittings and plugging head sealing elements can be manufactured and/or ordered.

Prior to ordering material, Contractor shall excavate at each proposed location and carefully measure the outside diameter of the water main with calipers along at least four (4) locations to determine ovality and the critical outside diameter of the water main. The Contractor shall determine main wall thickness, uniformity, and structural integrity by means of ultrasonic testing. Data shall be taken to determine extent of internal deposits, tuberculation, etc..

If the Engineer determines that Contractor's data are not adequate, the Engineer

DETAILED SPECIFICATION  
FOR  
**TEMPORARY WATER MAIN LINE STOP**

AA:MGN

5 of 7

11/20/22

may direct Contractor to make one or more pressure taps on main to obtain test pipe coupons for the Engineer's evaluation. The minimum size of the test coupon shall be 5" diameter, drilled through a nominal 6" valve. Pressure tapping saddles and other materials used for inspection taps shall conform to the requirements of this DETAILED SPECIFICATION. The Contractor shall anticipate that heavy interior corrosion and/or tuberculation exists within the water main.

If, in Engineer's opinion, the proposed location is unsatisfactory based on measurements of the existing pipe at the locations of the proposed line stops, the Engineer will direct excavation at another site. Excavating, de-watering, inspections, backfill, and restoration will be paid for separately in accordance with the applicable contract unit prices or Section 109.05.C and 109.05.D whichever the Engineer deems most appropriate.

Because of possible internal corrosion and deposits in existing water mains, a "bottle-tight" shut down may not occur. A satisfactory shutdown which allows the work to be accomplished (i.e. valve replacement, water main tie-in, etc.) using drainage pumps to de-water excavations, with workmen wearing boots and raingear, if necessary, must be obtained. The Contractor will not be allowed to proceed with further work until an acceptable shutdown is achieved. The Contractor shall be aware that this may require the halting of work and re-scheduling of all work operations.

Contractor shall power wire brush and grind the exterior of the water main to remove any debris, corrosion deposits, or other surface irregularities that might interfere with proper seating and sealing of each line stop fitting against each main. Any structural defects in the water main, service connections, appurtenances, adjacent utilities, etc., that could interfere with the line stop installation shall be immediately reported to Engineer.

All line stop fittings and appurtenances shall be cleaned and disinfected in accordance with the current City of Ann Arbor Public Services Area Standard Specifications prior to bolting any of the line stop fittings in place or commencing any pipe cutting.

Contractor shall fit upper and lower saddle plate assemblies to main, thoroughly checking for proper fit to main. Under no circumstances shall Contractor attempt to force, reshape, or bend saddle plates by excessive tightening of saddle studs while the line stop fitting is assembled around the main. Any required retrofitting shall be accomplished with the fitting removed from the main. Any damage to fitting, accessories, or main shall be repaired at Contractor's expense to the satisfaction of Engineer.



DETAILED SPECIFICATION  
FOR  
**TEMPORARY WATER MAIN LINE STOP**

AA:MGN

6 of 7

11/20/22

Upper and Lower saddle halves shall be drawn together by bolt assemblies and the Saddle plates shall be bolted together in the horizontal position.

All line stop work shall be performed in accordance with the equipment manufacturers approved work procedures and installation guidelines.

Final closure of the water main shall be accomplished by insertion of a manufacturer-approved completion plug. The Contractor shall test the completion plug sealing through the use of a bleed off assembly in the machine housing.

The Contractor shall remove the temporary valve and the installation of a blind flange shall be completed.

The Contractor shall place polyethylene encasement meeting the requirements of the City of Ann Arbor Standard Specifications for Construction around the upper and lower saddle halves, the blind flange, and to a point at least 1 foot on either side of the saddle halves. All polyethylene encasement shall be securely taped to the water main such that water entry is minimized to the greatest extent possible.

Lighting Requirements for Nighttime Water Main Work:

Night work shall be lighted to an average intensity of 108 lux minimum. Sufficient light sources shall be provided to achieve this illumination requirement. The lighting scheme shall be submitted to the Engineer for review and approval. Nighttime water main work will not be allowed to begin until such time as the lighting scheme has been approved by the Engineer.

The lighting shall allow the inspector to clearly see and inspect all work operations, including pipe, fitting, and valve installations, disinfection of the pipe, pipe cleaning, and all other night work.

Lighting systems may be fixed, portable, or equipment mounted. A power source shall be supplied with sufficient capacity to operate the lighting system. The lighting system(s) shall be arranged such that they do not interfere with the vision of motorists or unnecessarily illuminate surrounding properties or residences.

DETAILED SPECIFICATION  
FOR  
**TEMPORARY WATER MAIN LINE STOP**

AA:MGN

7 of 7

11/20/22

**e. Measurement and Payment.**- The completed work will be paid for at the contract unit prices for the following contract items (pay items):

<u><b>Contract Item (Pay Item)</b></u>	<u><b>Pay Unit</b></u>
Line Stop, Ductile/Cast Iron Pipe, __ inch .....	Each
Line Stop, Additional Rental Day.....	Each

All work shall be paid in full at the contract unit prices which shall include all the labor, materials, and equipment required to perform the work as detailed herein. This shall also include all required costs associated with night time work, supplemental lighting, and all other required elements of the work.

“Additional Rental Day” will be paid for each day after the first installation and day of use of a temporary water main line stop, regardless of size, until, in the opinion of the Engineer, the line stop is no longer needed.

Pavement removal, aggregate base course, bituminous pavement, and traffic control items as necessary to construct the line stop (as determined by the Engineer), shall be paid for separately as specified elsewhere; all other items shall be included in the pay item for the line stop.

CITY OF ANN ARBOR  
DETAILED SPECIFICATION  
FOR  
**WATER MAIN AND APPURTENANCES**

AA:MGN  
AJK:

1 of 28

11/12/15  
Rev. 08/16/2022

**a. Description.-** The Contractor shall furnish all labor, equipment, pipe, valves, fittings, restrained-joint pipe, restrained-joint gaskets, special gaskets as detailed on the plans and in the specification, polywrap, blow-off assemblies, fire hydrants, fire hydrant extensions, supplemental lighting towers, and all other materials necessary to complete the work as shown on the Plans, as detailed in this Detailed Specification, and as directed by the Engineer.

All water main installation and testing procedures shall be performed in accordance with the plans, the requirements of this Detailed Specification, and as directed by the Engineer.

The work for all items shall include, but not be limited to; pavement saw-cutting; excavation and disposal of excavated material; connections to new and existing water mains; the furnishing and installation of solid sleeves and push-on-joint plugs where needed; the furnishing, installation, and removal of sheeting and/or shoring where needed; all items necessary for the protection of the trench and all persons employed in the work during the work day and “after-hours” periods; polywrap; the furnishing, placement and compaction of approved bedding and backfill materials; thrust blocks; additional labor and equipment costs associated with any required nighttime water main work; cleaning, disinfecting, flushing, bacteriological and hydrostatic testing; and any other required items to complete the work as shown on the plans, as detailed in this Detailed Specification, and as directed by the Engineer.

The work of installing a gate valve-in-well shall include installation and backfill of the specified valve, furnishing and installing pre-cast concrete gate wells including the concrete base, straight pre-cast concrete sections, transition sections, and the adjustment of the structure cover. No separate payment will be made for adjusting the structure covers on new gate wells. The gate well cover shall be paid as “Dr Structure Cover.” Upon completion of the work, the Contractor shall clean the Gate Well to the approval of the Engineer.

The gate valve box shall be paid for as “Dr Structure Cover.” The cost of adjusting new gate valve-in-boxes shall be included in the unit price for Gate Valve-in-Box and shall not be paid for separately.

The fire hydrant assembly work shall include the hydrant, the 6 inch gate valve-in-box, 3 feet of 6 inch pipe, the thrust block, and any required extensions to install the fire hydrant to the finish grade as shown on the plans.

CITY OF ANN ARBOR  
DETAILED SPECIFICATION  
FOR  
**WATER MAIN AND APPURTENANCES**

AA:MGN  
AJK:

2 of 28

11/12/15  
Rev. 08/16/2022

**b. Materials.-**

1. Submittals. Prior to beginning construction, the Contractor shall submit the following:
  - A. Product data on all ductile iron pipe, valves, fittings, asbestos concrete pipe to ductile iron pipe fittings, and hydrants.
  - B. Manufacturer's certifications on all pipe, fittings, and precast concrete units indicating that all materials meet the minimum requirements of these specifications.
  - C. Information on equipment and methods to be used for flushing, chlorination, pressure and bacteriological testing.
2. General Specifications.
  - A. Cast Ductile Iron Pipe and Fittings:

Cast ductile iron pipe shall be Iron Grade 60-42-10 and meet the requirements of ANSI/AWWA C151/A21.51 in all respects; with standard thickness cement mortar lining and asphaltic seal coat in accordance with ANSI/AWWA C104/A21.4; and, coated outside with an asphaltic coating in accordance with ANSI/AWWA C151/A21.51. 100% of the ferrous metals used in the manufacture of cast ductile iron pipe shall be recycled from scrap and other sources. All pipe shall be Pressure Class 350 (Table 50.5 ANSI/AWWA C150/A21.50), or Thickness Class 50 (Table 50.15, ANSI/AWWA C150/A21.50). Ductile iron pipe crossing under a railroad shall be thickness Class 56.

Cast ductile iron river crossing pipe shall be Clow Corp. "F-141 River Crossing Pipe", U.S. Pipe "USIFLEX Boltless Flexible Joint Pipe" or equal approved by the Engineer, and shall be thickness Class 56 minimum. The pipe shall have a boltless flexible joint of the ball and socket type, and be designed for, and rated at, a minimum interior working water pressure of 250 psi.

Restrained joint pipe, where called for on the Plans, shall be factory

CITY OF ANN ARBOR  
DETAILED SPECIFICATION  
FOR  
**WATER MAIN AND APPURTENANCES**

AA:MGN  
AJK:

3 of 28

11/12/15  
Rev. 08/16/2022

manufactured by the installation of retainer weldment and ductile iron locking segments or rings. Restrained joint pipe shall be TR-Flex restrained joint pipe manufactured by U.S. Pipe, Lok-Ring joint pipe manufactured by American Ductile Iron Pipe, or equal as approved by the Engineer.

Cast ductile iron fittings shall be push-on joint, unless otherwise specified (with the exception of solid sleeves and fire hydrants which shall be mechanical joint), meeting the requirements of ANSI/AWWA C110/A21.10 for short body cast iron fittings. Fittings shall have a cement mortar lining and asphaltic seal coat in accordance with ANSI/AWWA C104/A21.4 and ANSI/AWWA C110/A21.10. The outside of all fittings shall have an asphaltic coating in accordance with ANSI/AWWA C110/A21.10.

Solid sleeves shall be long-pattern sleeves.

**B. Gate Valves and Gate Valve Boxes:**

All gate valves shall be resilient seated meeting the requirements of AWWA C509. All valves shall be of the push-on joint type, unless used on tapping sleeve assemblies, or noted otherwise on the plans. The valves supplied shall be:

- a. Metroseal 250 Resilient Seated Gate Valve as manufactured by U.S. Pipe & Foundry Company
- b. U. S. Pipe and Foundry Tyton Joint, Resilient Wedge Seated Gate Valve, meeting the requirements of AWWA C 509, AWWA C550, and ASTM D 2794
- c. American Flow Control, Series 2500, Single Resilient Wedge
- d. East Jordan Iron Works FlowMaster Resilient Wedge Valve
- e. Mueller Series, 4" through 12", A-2360-38, Resilient Wedge – SL x SL
- f. Tyler Series DRS 250-22 Double Resilient Wedge

All valves shall come equipped with a two-inch square operating nut, opening right.

Valve Boxes shall be Tyler 6860 Buffalo type, Size D, screw-type, 3 piece, 5-1/4 inch shaft and a No. 6 Base for a valve 8 inches or less and a No. 8

CITY OF ANN ARBOR  
DETAILED SPECIFICATION  
FOR  
**WATER MAIN AND APPURTENANCES**

AA:MGN  
AJK:

4 of 28

11/12/15  
Rev. 08/16/2022

base for 10 and 12 inch valves.

C. Gate Valve Wells:

Pre-cast reinforced concrete bases, bottom sections, manhole risers, grade adjustment rings, concentric cones, eccentric cones, and flat-slab tops shall conform to the requirements of ASTM C-478. Joints on precast gate wells shall meet the requirements of ASTM C-443, rubber O-ring gasket.

Flat-slab top, pre-cast, gate wells shall be designed to accommodate HL-93 Modified Live Load requirements as determined by a Professional Engineer licensed by the State of Michigan, regardless of where they are to be installed. For the purposes of design, a HL-93 Modified Live Load shall consist of 1.2 times the design truck or 1.2 times a single 60 kip load, whichever produces the greater stresses.

D. Fire Hydrants:

Fire hydrants shall be either the East Jordan Model Watermaster 5BR250 with traffic flange, or the Waterous Pacer Model WB67-250 with traffic flange. All fire hydrants shall have the following features: a 6 inch push-on tyton joint connection, ANSI/AWWA C111/A21.11; one 5 inch storz connection; one 3-3/8 inch threaded Ann Arbor Standard pumper connection with 7-1/2 threads per inch and 4.05 in. O.D.; 1-3/8 inch pentagon operating and cap nuts (1-3/8 in. point-to-flat at top; 1-7/16 in. point-to-flat at base); open left; breakable flange construction; no barrel drain; and a painted red finish. Depth of bury (bottom of pipe to ground surface) is generally 6 feet but may vary depending on specific site conditions. The pumper nozzles must be 21 in.  $\pm$  3 in. above finished grade, and the breakable traffic flange must be between finished grade and 8 in. above finished grade. Fire hydrant extensions for Waterous hydrants shall be Waterous Part #K562. Extensions for East Jordan hydrants shall be hydrant model 5BR250 extension kits. All fire hydrants must be certified by Underwriters Laboratory (UL) or the National Sanitation Foundation (NSF) for use in a potable water system.

A. Tapping Sleeves and Valves:

CITY OF ANN ARBOR  
DETAILED SPECIFICATION  
FOR  
**WATER MAIN AND APPURTENANCES**

AA:MGN  
AJK:

5 of 28

11/12/15  
Rev. 08/16/2022

Tapping sleeves and valves shall be manufactured of cast iron or stainless steel and designed for water service with a minimum working pressure of 150 psi. The sleeve shall be a full-bodied split sleeve design manufactured by one of the following manufacturers:

- a) Clow No. F-5205;
- b) Mueller Co. No. H-615;
- c) Waterous Series 800;
- d) East Jordan Iron Works MJ Tapping Sleeve with East Jordan FlowMaster RW Valve;
- e) Tyler/Union D.I. MJ Tapping Sleeve;
- f) Ford Meter Box Company Style FTSS;
- g) Power Seal Model No. 3490 AS;
- h) Smith Blair Model No. 622;
- i) JCM 432 All Stainless Steel Tapping Sleeve; and
- j) Price Brothers Company Tapping Sleeve for Prestressed Concrete Steel Cylinder Pipe (only to be used on concrete water mains.)

Tapping Sleeves for Pre-stressed Concrete Steel Cylinder Pipe shall be in accordance with AWWA M-9. The sleeves shall have a separate gland which permits installation of the sleeve prior to cutting of the prestress wires. The gland shall have a fusion epoxy coated (per AWWA C-213) waterway, and a broad gasket set in a retaining groove of a pressure plate gusseted to eliminate flexing. The gland shall be equipped with load bearing set screws to protect the cylinder. Grout under saddle is needed whether saddle is epoxy coated or not. Sleeves shall be furnished with grouting seals and grout horns to facilitate filling the space between the sleeve and the pipe. Tapping sleeves shall be a Price Brothers Company Tapping Sleeve for Prestressed Concrete Steel Cylinder Pipe or approved equal.

Tapping valves shall be double-disk type of the same manufacture as the sleeve, NRS with two-inch square operating nut-opening right, with a mechanical joint outlet.

All tapping sleeves and valves must be certified by Underwriters

CITY OF ANN ARBOR  
DETAILED SPECIFICATION  
FOR  
**WATER MAIN AND APPURTENANCES**

AA:MGN  
AJK:

6 of 28

11/12/15  
Rev. 08/16/2022

Laboratory (UL) or the National Sanitation Foundation (NSF) for use in a potable water system.

**B. Asbestos Concrete Pipe to Ductile Iron Pipe Coupling:**

The asbestos concrete pipe to ductile iron pipe coupling shall be the “Smith-Blair 415 (23.15”—21.60”) Gaskets, Alloy bolts and Epoxy” coupling or equivalent.

**C. Joints:**

Push-on joints shall be single gasket joint meeting the requirements of ANSI/AWWA C111/A21.11.

Mechanical joints for fire hydrants and solid sleeves shall be in accordance with ANSI/AWWA C111/A21.11 and shall be the Mega Lug Series 1100 joint restraint system manufactured by EBAA Iron Sales, Inc. or the Ford Meter Box Co. Uni-flange Retainer (UFR 1400-D-x style.)

Bolts for mechanical joints shall be high strength, low alloy steel bolts, only, meeting the requirements of ANSI/AWWA C111/A21.11. All bolts, nuts, and washers if required, shall be coated with a factory-applied flouropolymer coating meeting the following requirements:

- Use Temperature: -100°F to 500°F
- Salt Spray – ASTM B117 up to 4000 hours (nuts must not become frozen)
- Pencil Hardness – 5H to 6H – ASTM D3363-92A
- Kinetic Coefficient of Friction – 0.06 to 0.08
- Thickness – nominal 0.001” (1 mil)
- Impact – 160 in-lbs as measured by ASTM D2794-93
- Adhesion – 5B – ASTM D3359-95
- Di-electric Strength – 500V per mil
- Elongation – 35% to 50%
- Tensile Strength – 4,000 psi
- Operating Pressure – up to 100,000 psi
- Kesternich Test – Nuts not frozen up to 30+ cycles (DIN 50018)



CITY OF ANN ARBOR  
 DETAILED SPECIFICATION  
 FOR  
**WATER MAIN AND APPURTENANCES**

AA:MGN  
 AJK:

7 of 28

11/12/15  
 Rev. 08/16/2022

Corrosion Resistance: as measured by;

ASTM D 1308	Muriatic Acid 31% HCL	24 hours	No Effect
	Sulfuric Acid 93% H <sub>2</sub> SO <sub>4</sub>	24 hours	No Effect
	Caustic Soda 100% NaOH	24 hours	No Effect
	Methy Ethyl Keytone MEK	24 hours	No Effect
ASTM B117	Salt Fog	1,000 hours	No Effect

The flouropolymer coating shall strongly adhere to surface being coated and shall not flake off or be easily removed by rubbing or brushing.

Cast ductile iron river crossing pipe joints shall be a push-on type ball and socket joint utilizing a first grade rubber gasket. The joint shall be capable of 15-degree full turning deflection without separation, leakage, or restriction of the pipe waterway. Joint restraint shall be provided by a boltless means which is locked against accidental disengagement of the restraining component. Pipe shall be furnished with the necessary gaskets, lubricant, and retainer locking accessories.

Joints for restrained joint pipe shall be in accordance with ANSI/AWWA C111/A211.11. Bolts and nuts for the retainer assembly shall be stainless steel.

Restrained, push-on joint, pipe shall be American Pipe's "Fast-Grip" gasket system, U.S. Pipe's "Field-Lok 350" gasket system, or Griffin Pipe "Field Lok 350" gasket system.

The use of retainer glands and set screws shall not be acceptable.

Lubricants used in making up joints shall be supplied by the pipe manufacturer and the joints shall be coupled in accordance with the manufacturer's requirements.

**D. Pipe Wrapping:**

All Cast Ductile Iron Pipe, Fittings, and Valves (except river, railroad and highway crossing pipe) shall be fully wrapped with polyethylene per ANSI/AWWA C105/A21.5 and the details as contained on the plans.

CITY OF ANN ARBOR  
 DETAILED SPECIFICATION  
 FOR  
**WATER MAIN AND APPURTENANCES**

AA:MGN  
 AJK:

8 of 28

11/12/15  
 Rev. 08/16/2022

E. Anodes

Anodes shall be high potential magnesium anode ingots with packaged backfill. Anode ingot shall meet or exceed ASTM B843, Grade M1C for high-potential magnesium anodes.

Anode shall come furnished with minimum 10 feet of coiled #12 AWG solid copper lead wire with TW, THHN or THWN insulation, firmly attached to the galvanized steel core of the anode. The core cavity shall be filled with electrical sealing compound to assure a fully insulated and protected connection. Magnesium anode and backfill shall be pre-packaged into a single unit in a permeable cloth bag.

Connection of anode lead wire to cast iron or ductile iron pipe or fittings shall be made by the thermite weld method. Thermite weld materials shall consist of wire sleeves, weld mold and weld cartridges according to the weld manufacturer's recommendations for the specific wire and pipe sizes and materials. Weld materials from different manufacturers shall not be interchanged. Weld molds shall be graphite molds. Ceramic "one -shot" molds will not be acceptable.

E. Casing Pipe:

Steel casing pipe used for construction at railroad or State highway crossings shall comply with the following minimum requirements unless more stringent requirements are established by the railroad or State. Casing pipes at other locations shall comply with the following minimum requirements unless otherwise indicated on the Plans or in the Specifications.

Nominal Diameter of Casing Pipe (Inches)	Minimum Wall Thickness (Inches)
Under 14	0.250
14, 16, and 18	0.312
20 and 22	0.375
24, 26, 28, and 30	0.500

CITY OF ANN ARBOR  
DETAILED SPECIFICATION  
FOR  
**WATER MAIN AND APPURTENANCES**

AA:MGN  
AJK:

9 of 28

11/12/15  
Rev. 08/16/2022

32 and 34	0.563
36, 38, 40, 42, and 48	0.625

Steel pipe shall be non-spiral pipe and have a minimum yield strength of 35,000 psi. All joints shall be made leakproof using full penetration, continuous welds. Welds shall be ground smooth outside and inside (except inside 22 in. diameter and less) to prevent conflict with the soil or pipe placement. Steel pipe shall meet the requirements of ASTM A 53, Type E or S, Grade B.

#### Pipe Marking

The following information shall be clearly marked on each length of pipe:

- a) The pipe designation and class (e.g. A 53, Type S, Grade B.)
- b) The name or trademark of the manufacturer.
- c) Identification of the manufacturing plant.

#### Inspection

All casing pipe furnished shall be subject to inspection on arrival at the job site by the Engineer. The purpose of the inspection shall be to cull and reject pipe that, independent of physical tests specified under the standard specifications designated herein, fails to conform to the requirements of these Specifications.

Rejected pipe shall be plainly marked by the Inspector and immediately removed from the site of the work by the Contractor, without cost to the City.

#### F. Water Main Pipe Marking:

The following information shall be clearly marked and/or cast on each length of pipe:

- a) The pipe designation and class (e.g., D.I., Class 50).
- b) The name or trademark of the manufacturer.

CITY OF ANN ARBOR  
DETAILED SPECIFICATION  
FOR  
**WATER MAIN AND APPURTENANCES**

AA:MGN  
AJK:

10 of 28

11/12/15  
Rev. 08/16/2022

- c) Country where cast.
- d) The year in which the pipe was produced.

The following shall be distinctly cast on each fitting:

- a) The pressure rating of the fitting.
- b) Nominal diameters of openings.
- c) The name or trademark of the manufacturer.
- d) Country where cast.
- e) The number of degrees or fraction of the circle on all bends.
- f) Ductile iron fittings shall have the letters "DI" or "Ductile" cast on them.

G. Manufacturer's Certification:

All pipe furnished shall be accompanied by the manufacturer's certificate of test showing conformity with the Specifications. Each certificate shall identify a specific lot number, quantity of pipe, and show actual test results for the lot furnished. These certificates shall be submitted to the Inspector at the time of unloading.

All materials that will potentially be in contact with the City of Ann Arbor water supply must be certified by Underwriters Laboratory (UL) or the National Sanitation Foundation (NSF) for use in a potable water system. These materials shall include pipe coatings, pipe metals, cement linings, and joint lubricants and gaskets.

H. Inspection:

All pipe furnished shall be subject to inspection on arrival at the job site by the Engineer. The purpose of the inspection shall be to cull and reject pipe or fittings that, independent of physical tests specified under the standard specifications designated herein, fail to conform to the requirements of these Specifications.

The Contractor shall notify the Engineer sufficiently in advance so that an Inspector may be on the job during the unloading of materials. A minimum notice of 24 hours is required for such unloading and inspection. The Contractor shall also notify the Engineer when the material has arrived at

CITY OF ANN ARBOR  
DETAILED SPECIFICATION  
FOR  
**WATER MAIN AND APPURTENANCES**

AA:MGN  
AJK:

11 of 28

11/12/15  
Rev. 08/16/2022

the site.

All ductile iron water main pipe shall be stacked on pallets off of the existing grade, with each end plugged or bagged so as to keep the pipe interior clean until final installation.

Cast ductile iron pipe and fittings shall be subject to rejection on account of any of the following:

- a) Variation in any dimension exceeding the permissible variations given in the material specifications.
- b) Any crack or defect in the cement mortar lining which, in the opinion of the Engineer, is non-repairable, including, but not limited to, loose or "hollow" lining.
- c) Any signs of physical damage or poor manufacturing which might render the material unsuitable for its intended use.
- d) Variation of more than 1/16 inch per lineal foot in alignment of pipe intended to be straight.
- e) Damaged ends, where in the judgment of the Engineer such damage would prevent making a satisfactory joint.
- f) Improper handling during delivery, unloading, or installation.

Rejected pipe shall be plainly marked by the Inspector and immediately removed from the site of the work by the Contractor, without cost to the City.

**I. Water Main Bedding and Backfill Materials:**

Bedding and backfill material for Trench Detail I (under roadbed), Modified, shall be Granular Material, Class II, meeting the requirements of Section 902. Bedding and backfill for Trench Detail V (outside of the 1:1 influence line of roadbed or curb and gutter), Modified, shall be Granular Material, Class II and Engineer approved native material, placed in accordance with the trench details.

**c. Water Main Installation, Bacteriologic and Hydrostatic Testing, and Acceptance Requirements.-** Installation of proposed water mains will require work in close proximity to existing utilities. This must be taken into consideration when the

CITY OF ANN ARBOR  
DETAILED SPECIFICATION  
FOR  
**WATER MAIN AND APPURTENANCES**

AA:MGN  
AJK:

12 of 28

11/12/15  
Rev. 08/16/2022

contractor determines the required trench safety requirements. All excavation shall conform to all relevant MIOSHA Standards; the Contractor is solely responsible for determining all excavation and trench safety requirements.

A. Dry Tap:

When a connection to an existing water main is to be made in the dry, the existing main to which a connection is to be made shall be isolated by the closing of the necessary existing valves, and the water from the existing main shall then be pumped out or removed by other means so that the connection may be made in the dry. All pipe materials and appurtenances which will come into contact with potable City water after the restoration of water service following the connections shall be disinfected with a strong chlorine solution prior to installation.

The Contractor may not operate City water main valves. For valve operation, contact City of Ann Arbor Public Services Area personnel; the City of Ann Arbor personnel will direct the operation of all valves by Contractor personnel. It is recommended that the Contractor request that the existing valves, which will need to be operated in order to perform the water main work, are checked in advance of the work to ensure that they operate properly. If the Contractor elects not to request the operation of the valves in advance of any required water main operation, then a request for extension of contract time will not be allowed.

It is possible that the valves which need to be operated to facilitate a shutdown will not close entirely, thereby allowing water to leak past the valve into the area of the shut down. The Contractor shall provide the necessary labor, material, and equipment to enable work to be completed with a poor shut down. Under no circumstances shall the Contractor be compensated for "downtime" associated with water main valve or appurtenance failure or its inability to properly operate or close fully. An extension of contract time may be allowed, if the Contractor has requested that the water main valves have been exercised in advance of the intended water main shutdown.

Due to the size and length of pipe being shut down, and the quality of shut-down attained, large amounts of water may need to be removed from the excavation. Where possible, the water shall be run directly into nearby storm sewer inlets via pumps and hose.

The Contractor shall have all pipe, fittings and appurtenances required to

CITY OF ANN ARBOR  
DETAILED SPECIFICATION  
FOR  
**WATER MAIN AND APPURTENANCES**

AA:MGN  
AJK:

13 of 28

11/12/15  
Rev. 08/16/2022

complete the water main connection prior to the excavation for the connection, or the work will not be allowed to commence.

The Contractor shall complete the water main work in a manner which minimizes the disruption of water service to the greatest extent possible.

The City must notify all businesses 48 hours in advance of a water main shut-down; residences must be notified 24 hours in advance. To give the City an opportunity to provide such notification, the Contractor shall schedule the water main shut-downs at least 72 hours in advance, and preferably a full four or five days in advance, of the water main shut-down.

No water main shutdown shall take place after 12:00 p.m. (noon), unless written permission has been granted by the Engineer and that the Contractor has sufficient lighting equipment to provide a safe and efficient work area for working after dark. No water main will be shut down until the main has been exposed and cleaned, and is ready to be cut.

There shall be no gap larger than 1/4 inch left in the existing water main as a result of the tie-in. If needed, a closure piece ("thrust ring") of such size so as to meet this requirement shall be installed.

**B. Wet Tap:**

Prior to the installation of a tapping sleeve, the section of pipe to be tapped shall be cleaned of all foreign material and wire brushed to a smooth surface. The two halves of the sleeve shall be placed around the pipe with the gaskets installed per the manufacturer's instructions. The bolts shall be tightened evenly from the center toward the ends. The bolts shall be tightened to the manufacturer's specified torque.

When performing a wet tap in a prestressed concrete steel cylinder water main, grout is to be placed under the tapping saddle whether or not the saddle is epoxy coated.

All pipe materials and appurtenances which may come into contact with potable City water shall be disinfected with a strong chlorine solution prior to installation. This includes the pipe section to be tapped, the two halves of the sleeve, gaskets

CITY OF ANN ARBOR  
DETAILED SPECIFICATION  
FOR  
**WATER MAIN AND APPURTENANCES**

AA:MGN  
AJK:

14 of 28

11/12/15  
Rev. 08/16/2022

and the gate valve.

Prior to installation of the end gaskets, the sleeve shall be blocked with cement bricks such that the outlet is in proper position. The end gaskets shall be installed with an overlap as specified by the manufacturer.

The glands shall be assembled on the pipe. The bolts around the gland shall be tightened evenly, causing the gaskets to uniformly compress.

The valve shall be installed on the sleeve following the manufacturer's instructions.

Prior to tapping, the assembly shall be tested using the test plug tap in the sleeve with the valve closed, or by placing a tapped plug on the outlet of the valve with the valve open. The assembly shall be pressurized to 150 psi and hold the pressure fifteen minutes.

After the pressure test is complete, the pipe shall be tapped.

C. Oversized Water Mains:

Portions of the proposed water mains or fittings may connect with existing water mains or fittings. The possibility exists that some of the existing water mains may have been constructed using oversized, cast iron, pipe. Where tie-ins or interconnections are specified and the existing main is found to be oversized, the Contractor shall furnish and install Clow 3501B Sleeves, Tyler Dual Sleeve 5-146L, or Rockwell 441 Sleeves. These sleeves are to be present on the jobsite prior to the excavation for the water main connection, or the work will not be allowed to commence.

D. Permissible Deflection at Joints:

Wherever it is necessary to deflect ductile iron pipe from a straight line, either in the vertical or horizontal plane, to avoid obstructions, to plumb valve stems, or where long-radius curves are permitted, the amount of deflection allowed shall not exceed that required for satisfactory making of the joint, and shall be approved by the Engineer. The deflection shall not exceed the following amounts:

Size of	Joint Angle	Deflection	Approx. Radius of Curve
---------	-------------	------------	-------------------------



CITY OF ANN ARBOR  
 DETAILED SPECIFICATION  
 FOR  
**WATER MAIN AND APPURTENANCES**

AA:MGN  
 AJK:

15 of 28

11/12/15  
 Rev. 08/16/2022

Pipe (Inches)	(Degrees)	in 18 ft. (Inches)	Produced by Succession of 18 ft. Lengths (Feet)
4	5	19	205
6	5	19	205
8	5	19	205
10	5	19	205
12	5	19	205
16	3	11	340
20	3	11	340
24	3	11	340
30	3	11	340

The above joint deflection angles apply to fittings as well as pipe joints.

**E. Trench Opening:**

The width of the trench shall be ample to permit the pipe to be laid and jointed properly, and the backfill to be placed and compacted as specified. Trenches shall be of such extra width, when required, to permit the convenient placing of timber supports, sheeting and bracing, and handling of special fittings. For each size of pipe, the minimum trench width shall provide clearance of four inches on each side of the bell of the pipe or fitting or six inches on each side of the pipe barrel, whichever is greater. The maximum trench width shall be in keeping with good construction practice, such that existing structures are not undermined.

In excavating for water mains, the excavation shall at all times be finished to the required grade in advance of the pipe line, but unless otherwise permitted in writing by the Engineer, not more than 50 feet of trench shall be open at one time in advance of the pipe. At no time shall more than 200 feet of trench be opened and incompletely backfilled. At the end of each day, no more than 25 feet of trench may be left open, and access to all drives shall be restored. This opening shall be surrounded by fencing and barricades, or plated. The remainder of the trenching operation shall be available for safe vehicular and pedestrian traffic at all times.

The trench shall be so braced and drained that the workers may work therein safely and efficiently. It is essential that the discharge of the trench de-watering pumps be conducted to natural drainage channels, drains, or storm sewers. If trench water is pumped to natural drainage channels or drains, approved soil erosion and sedimentation controls shall be installed and maintained at the point of

CITY OF ANN ARBOR  
DETAILED SPECIFICATION  
FOR  
**WATER MAIN AND APPURTENANCES**

AA:MGN  
AJK:

16 of 28

11/12/15  
Rev. 08/16/2022

discharge. If trench water is pumped into storm sewers, filters shall be provided to prevent the flow of rocks, mud and other debris into the storm sewer line.

The length of street which may be occupied by the construction work at any one time shall be subject to the approval of the Engineer and will be based on the requirements of use of the street by the public.

The Contractor shall fully comply with all laws and regulations governing construction methods and the furnishing and use of all safeguards, safety devices, protective equipment, and pollution controls. Particular care shall be taken to conform to all applicable rules of the Michigan Department of Labor, Construction Safety Standards Commission, "Safety Standards". Part 9 of the above document should be particularly noted.

Where required to support the surfaces of adjacent throughfares, structures, or excavations, or to protect the construction work, adjacent work, or workmen; sheeting, bracing, and shoring shall be provided. The placing of such supports shall not release the Contractor of the responsibility for the sufficiency and integrity of the trench opening. In the removing of sheeting and bracing after the construction has been completed, special care shall be taken to prevent any caving of the sides of the excavation and injury to the completed work or to adjacent property.

Sheeting, bracing, and shoring shall not be left in place after completion of the work except as required by the Engineer. Where the Engineer requires the sheeting, bracing, or shoring to be left in place it shall be cut off below the established surface grade as required by the Engineer.

Laying Pipe:

Each pipe shall be inspected for defects prior to being lowered into the trench. Inside of pipe and outside of spigot shall be cleaned of any earth or foreign matter.

Proper implements, tools, and facilities satisfactory to the Engineer shall be provided and used by the Contractor for the safe and convenient prosecution of the work. All pipe, fittings, valves, and hydrants shall be carefully lowered into the trench piece by piece by means of an excavator using chains, slings, or other suitable tools or equipment as recommended by the manufacturer, in such a manner as to prevent damage to them and their protective coatings and linings. Under no circumstances shall materials be dropped or dumped into the trench.

CITY OF ANN ARBOR  
DETAILED SPECIFICATION  
FOR  
**WATER MAIN AND APPURTENANCES**

AA:MGN  
AJK:

17 of 28

11/12/15  
Rev. 08/16/2022

New water main construction shall not be connected into the existing system until it has been tested and accepted by the Engineer. Pipe shall be laid on the prepared trench bottom with the bell ends facing the direction of laying, unless otherwise directed by the Engineer.

The Contractor shall take every precaution to prevent foreign material from entering the pipe while it is being placed in the line. During laying operations, no debris, tools, clothing or other materials shall be placed in the pipe. At times when pipe laying is not in progress, the open ends of pipe shall be closed by a **watertight** plug. This provision shall apply during the noon hours as well as overnight. If water is in the trench, the seal shall remain in place until the trench is pumped completely dry.

Pipe shall be jointed as specified elsewhere herein. The pipe shall be secured in place with approved backfill material tamped under it except at the bells. Pipe and fittings which do not allow a sufficient and uniform space for joints shall be removed and replaced with pipe and fittings of proper dimensions to insure such uniform space. Precautions shall be taken to prevent dirt from entering the joint space.

All pipe shall be laid at the correct line and grade as indicated by the grade stakes and offset line. Each pipe, as laid, shall be checked by the Contractor to insure that this result is obtained. The staking shall be provided by the Engineer. No pipe shall be laid until a cut sheet for that pipe has been approved by the Engineer. The grade as shown on the Plans is that of the top-of-pipe for water main; and the work must conform to this profile. For water main construction, a variation from the profile grade of two inches with ductile iron pipe, and three inches with reinforced concrete pipe, will be deemed sufficient reason to cause the work to be rejected and re-laid. Water main pipe alignment shall be maintained so as not to vary more than three inches from the correct line. Any pipe found out of line shall be re-laid properly by the Contractor.

Due to conditions in the field, changes to the proposed vertical and horizontal alignment of the proposed water main may become necessary. The Contractor shall, where directed by the Engineer, excavate up to 60 feet in advance of the pipe laying operation to expose existing underground facilities thereby enabling the Engineer to make alignment decisions. The Contractor is required to realign (re-lay) the water main up to 2 feet vertically and/or horizontally as directed by the Engineer

CITY OF ANN ARBOR  
DETAILED SPECIFICATION  
FOR  
**WATER MAIN AND APPURTENANCES**

AA:MGN  
AJK:

18 of 28

11/12/15  
Rev. 08/16/2022

at no extra cost to the project. The excavation in advance of the pipe laying is intended to help eliminate the need for re-laying pipe.

F. Crossing Existing Structures and Facilities:

During the construction it may be necessary to cross under or over certain sewers, drains, culverts, water lines, gas lines, electric lines, fiber optic communication, telecommunication, and other types of underground structures or facilities, known or unknown. The Contractor shall make every effort to prevent damage to such underground structures and facilities. The Contractor shall not intentionally damage or break existing structures or facilities and repair them in order to expedite the water main installation process. Wherever such structures or facilities may inadvertently be disturbed or broken, they shall be restored to a condition that is equal to, or better than, that was encountered prior to the damage. All damaged structures and/or facilities shall be made fully acceptable to the owner and the City, at the Contractor's expense. All crossings shall be made with a minimum of twelve inches of vertical clearance between or alongside existing structures or facilities.

G. Cutting Pipe:

Cutting cast iron or ductile iron pipe for inserting valves, fittings, or closure pieces shall be performed in a neat and workmanlike manner without damage to the pipe or cement lining and so as to leave a smooth end at right angles to the longitudinal axis. Where the type of pipe joint in use is such that it employs push-on assembly to effect the joint seal, the outside of the cut end shall be tapered back 1/8 inch with a coarse file or a portable grinder at an angle of about 30 degrees. The tapering must remove all sharp and/or rough edges which might injure the gasket.

The flame cutting of pipe will not be allowed. Reinforced concrete water main pipe shall not be cut.

I. Setting Water Main Fittings and Accessories:

Valves, fittings, plugs, hydrants, etc. shall be set and joined to pipe in the manner specified in the Section entitled "Making Joints."

Hydrants shall be located as shown on the Plans or as directed by the Engineer

CITY OF ANN ARBOR  
DETAILED SPECIFICATION  
FOR  
**WATER MAIN AND APPURTENANCES**

AA:MGN  
AJK:

19 of 28

11/12/15  
Rev. 08/16/2022

in such a manner as to provide complete accessibility and minimize the possibility of damage from vehicles or injury to pedestrians.

J. Making Joints:

Mechanical means shall be used for pulling home all rubber-gasket pipes regardless of trench condition where manual means will not result in pushing and holding the pipe home. When a trench box or liner is used, a cable shall be used to pull the joints home and hold them in position.

Where work is performed in wet trenches or trenches with running sand, the Contractor shall provide and use mechanical means for pulling the pipe home in making up the joint and for holding the pipe joints tight until completion of the line. Mechanical means shall consist of a cable placed inside or outside of the pipe with a suitable winch, jack, or come-along for pulling the pipe home and holding the pipe in position.

Where not required by these Specifications, manual means will be acceptable only if the joints can be pushed home and held.

Hydrants shall be set to stand plumb with their nozzles parallel to the street and the pumper nozzle facing the street. Hydrants shall be set with pumper nozzles between 18 and 24 inches above finished grade, or as directed in writing by the Engineer.

K. Anchorage for Water Main Fittings and Accessories:

All plugs, caps, tees, hydrants, and bends shall be provided with MDOT Grade S2 concrete meeting the requirements of Section 1004 of the 2020 MDOT Standard Specifications for Construction reaction backing (thrust block) as shown on the Plans or specified herein. Valves shall be restrained from movement at adjacent sleeves by the use of a closure piece, or thrust ring (full size pipe section cut to fill the gap inside the sleeve to within 1/4") as specified herein.

Reaction backing shall be placed between unexcavated solid ground and the fitting to be anchored. The area of bearing on the pipe and on the ground in each instance shall be that shown on the details or directed by the Engineer. The reaction backing shall, unless otherwise shown or directed, be so placed that the pipe and fitting joints

CITY OF ANN ARBOR  
DETAILED SPECIFICATION  
FOR  
**WATER MAIN AND APPURTENANCES**

AA:MGN  
AJK:

20 of 28

11/12/15  
Rev. 08/16/2022

will be accessible for repairs. This shall include adequate protection of any bolts from direct contact with the concrete.

Metal harnesses of tie rods or clamps may not be used instead of concrete reaction backing. Mega-Lug joint restraint systems and restrained, push-on joint, pipe shall be used where connections to existing lines require immediate pressurization, as specified herein.

In the event that the Engineer determines a change in the anchorage or design is required due to unsuitable earth conditions, changes may be ordered by the Engineer.

The use of friction clamps or set-screw type retainer glands for thrust restraint will not be allowed.

L. Abandonment or Removal of Water Main:

The Contractor shall abandon or remove water main(s) where shown on the Plans. All work shall be performed in accordance with the Detailed Specification entitled "Water Main and Appurtenances, Remove or Abandon."

M. Water Main Testing:

The water main shall be disinfected and tested by the Contractor in the presence of the Engineer in accordance with the requirements below. The Contractor shall furnish all piping, pumps, hoses, gauges, and other materials and equipment required to carry out the tests using water from the City's water mains. All chlorinated water shall be discharged directly to the sanitary sewer and will not be allowed to be discharged to the ground or any surrounding water course. Any hoses which are needed to direct water from blow-offs and/or hydrants during water main testing and flushing shall be supplied by the Contractor. The City shall furnish and install one inch corporation stops at all necessary locations, at the expense of the Contractor. The tapping of water mains, the installation of all corporation stops, and the operation of valves and hydrants is reserved for City personnel. The Contractor is required to assist in valve and hydrant operation, however. The Contractor shall give the City forty-eight hours prior written notice of intent and desire to test water mains.

Bacteriological Testing Sequences:

CITY OF ANN ARBOR  
 DETAILED SPECIFICATION  
 FOR  
**WATER MAIN AND APPURTENANCES**

AA:MGN  
 AJK:

21 of 28

11/12/15  
 Rev. 08/16/2022

In the case of all water mains connected to existing facilities, flushing, chlorination and bacteriological testing must precede pressure testing. Where mains can be totally isolated from existing facilities with air gaps or double valves, pressure testing may precede chlorination and bacteriological testing. The normal sequence and time requirements for testing are:

Isolated (Gapped) Water Main	Connected Water Main
1. Fill Main	1. Flush and Swab*
2. Pressure Test	2. Chlorinate
3. Connect One End of Main	3. Wait; 24 hours
4. Flush and Swab*	4. Flush**
5. Chlorinate	5. Wait; 24 hours
6. Wait; 24 hours	6. Bacteriological Samples
7. Flush**	7. Wait; 24 hours
8. Wait; 24 hours	8. Bacteriological Samples
9. Bacteriological Samples	9. Wait; 48 hours
10. Wait; 24 hours	10. Pressure Test (If both sets of Bacteriological samples pass)
11. Bacteriological Samples	11. Flush
12. Wait; 48 hours	12. Wait; 24 hours
13. Make Final Connection(s) – Place in Service (If both sets of bacteriological samples pass)	13. Bacteriological Samples
	14. Wait; 24 hours
	15. Bacteriological Samples
	16. Wait; 48 hours
	17. Place in Service (If both sets of bacteriological samples pass)

\*Collect flush water in operable storm water retention/detention facility.

\*\*Discharge flush water into approved sanitary sewer.

The Contractor shall not connect any end of a newly constructed water main to an existing, in-service, water main, until the newly constructed water main passes the hydrostatic test, unless approved in writing by the Engineer.

**N. Hydrostatic (Pressure Test):**

Insofar as is practical, mains shall be pressure tested between valves. The

CITY OF ANN ARBOR  
 DETAILED SPECIFICATION  
 FOR  
**WATER MAIN AND APPURTENANCES**

AA:MGN  
 AJK:

22 of 28

11/12/15  
 Rev. 08/16/2022

maximum length of water main to be tested in any one test shall be 1500 feet. The section of main to be tested shall be slowly filled with potable water and the entrained air within the pipe removed or absorbed and pumped up to a pressure of 150 psi (or other pressure if specified) and the test period shall start immediately thereafter. The lines shall then be maintained under a test pressure of 145-155 psi for a continuous period of three hours by pumping chlorinated (25 ppm) water into the line at frequent intervals. The volume of water so added shall be measured and considered to represent the leakage from the line under test during the interval. Visible leaks shall be repaired regardless of test results. The leakage under the conditions of the test shall not exceed the values shown in the table below. If one side of a double disc gate valve is under test pressure, that seat shall count as four joints.

Maximum Allowable Leakage per 100 Joints at 150 psi Avg. Test Pressure

Pipe Diameter (Inches)	4	6	8	10	12	16	20	24	30	36
Leakage (gallons/hr)	0.66	0.99	1.32	1.66	1.99	2.65	3.30	3.97	4.97	5.96

In the event that the leakage exceeds the maximum allowable leakage as specified above, the joints in the line shall be carefully inspected for leaks and repaired where necessary. Any pipes or fittings found to be leaking shall be removed and replaced with new pieces by the Contractor. After this work has been performed, all tests shall be repeated.

**O. Flushing and Swabbing:**

The Contractor shall flush the water main after making a connection to the existing City water main where a valve separates the new water main from the existing main. As a result, flushing will be accomplished using flow through the full size of the new water main. If a storm water retention/detention facility is to be constructed as part of the project, this facility is to be completed, stabilized, operable, and utilized for the collection of the flushing water. All pipe, materials, and appurtenances which will come into contact with potable City water after the restoration of water service following the connection shall be disinfected with a strong chlorine solution prior to installation.

Water main shall be cleaned using a high density poly-pig, Girard Aqua Swab (2



CITY OF ANN ARBOR  
DETAILED SPECIFICATION  
FOR  
**WATER MAIN AND APPURTENANCES**

AA:MGN  
AJK:

23 of 28

11/12/15  
Rev. 08/16/2022

lbs/ft<sup>3</sup> density) swab, or Engineer approved equal and flushed. The diameter of the blow-off pipes shall be at least 50% of the diameter of the pipe being flushed. Hydrants, with internal components removed, may serve as blow-offs for mains 12 inches and less. The Contractor shall provide details, for the review and approval of the Engineer, for the various required blow-offs. Blow-off pipes, discharge hoses, where needed, and associated costs shall be included in the cost of the permanent water main being installed and will not be paid for separately. If there are no branch connections to be swabbed, the poly-pig shall be inserted in the new water main at the time of connection described above. The poly-pig shall be located on the "downstream" or new side of the separation valve. The poly-pig shall then be forced through the new water main during the first flush and discharged through a construction blow-off of sufficient size to allow passage of the poly-pig. For water mains with branch connections, a launching tee or wye shall be installed as shown in the details, for launching multiple poly-pigs. The main line and each branch main shall be flushed and swabbed individually. Following the successful final bacteriological testing of the water main, the launching tee/wye shall be permanently capped at its branch.

During the flushing and swabbing of a water main, the discharge point for the main shall be left open, with all other discharge points closed, to direct the poly-pig completely through the main being swabbed to its point of termination. Following the initial swabbing of water main, the separation valve shall be closed, and then the discharge point closed. If a branch water main is to be swabbed, the poly-pig is then to be placed in the launcher; the discharge point for the branch water main is to be opened; the poly-pig is to be inserted into the water main; the separation valve partially opened and the branch water main flushed and swabbed.

Following the swabbing of the water main(s), the water main(s) are to be flushed as required. If approved or directed by the Engineer, the water main(s) may be flushed overnight, provided that proper controls (i.e. hoses directed into storm structures, etc.) are installed to direct and control the flushing water.

CITY OF ANN ARBOR  
 DETAILED SPECIFICATION  
 FOR  
**WATER MAIN AND APPURTENANCES**

AA:MGN  
 AJK:

24 of 28

11/12/15  
 Rev. 08/16/2022

P. Chlorination:

After the water mains to be tested have been acceptably flushed, they shall be disinfected in accordance with AWWA C651 "Disinfecting Water Mains" and these Specifications. All new mains and fittings, and any existing mains contaminated by the Contractor, shall be chlorinated to a minimum residual of fifty (50) parts per million (ppm) with commercial liquid chlorine solution (sodium hypochlorite - pool type). Other forms of chlorination and disinfection methods of water mains may be presented by the Contractor and shall receive prior approval in writing by the Engineer before being used. The minimum recommended dosage of sodium hypochlorite is as follows (based on 10% available chlorine):

Recommended Minimum Chlorine Dosage to Disinfect 100 L.F. of Pipe

Pipe Diameter (inches)	10% Chlorine Solution (gallon)
6	0.153
8	0.272
10	0.426
12	0.613
16	1.090
20	1.703
24	2.452

The chlorinated water shall remain in the mains for a minimum of 24 hours, at the end of which period the chlorinated water at all parts of the main must show free available chlorine residual of at least twenty-five (25) ppm. If less than 25 ppm residual is shown at the end of the first 24 hour period, additional chlorine shall be added until a residual of not less than 25 ppm at all parts of the system is shown after a subsequent 24 hour period. The chlorinated water shall then be removed from the mains and disposed of into an existing, approved City sanitary sewer main, or other location approved in writing by the Engineer. All chlorinated water shall be discharged directly to the sanitary sewer and will not be allowed to be discharged to the ground or any surrounding water course. The mains shall then be left full of water ready for bacteriological testing.

CITY OF ANN ARBOR  
DETAILED SPECIFICATION  
FOR  
**WATER MAIN AND APPURTENANCES**

AA:MGN  
AJK:

25 of 28

11/12/15  
Rev. 08/16/2022

Q. Bacteriological Testing:

The City will obtain bacteriological samples of the water in the mains for analysis from testing blow-offs, corporations, or other sampling points as determined acceptable by the City. Samples will be taken after the mains have been satisfactorily chlorinated in accordance with these Specifications, the chlorinated water flushed out and removed, and the mains filled with potable water. The water samples will only be bacteriologically tested at the City's Water Treatment Plant Laboratory; the use of other laboratories or testing locations shall not be allowed or deemed to provide satisfactory test results by the City of Ann Arbor under any circumstance. No samples will be deemed acceptable until they meet all city requirements. If the newly constructed water main is connected at one end to an in-service section of the City water main, and the chlorination precedes pressure testing, the City will also take samples after satisfactory pressure testing. In each case, two sets of samples shall be taken; a period of 24 hours must elapse between flushing of the main and drawing of the first samples, with the second samples being drawn 24 hours after the first samples were drawn. For each sample, a minimum of 48 hours is required to obtain test results. All samples must pass the bacteriological test.

The Contractor shall plan for these testing sequences and durations in his construction schedule. Contract time will continue during all water main testing phases, regardless of duration.

**d. Construction, General Requirements.-** The Contractor shall be responsible for coordination with the City of Ann Arbor Field Operations Unit for the installation of 1-inch corporations in the gate wells to be used for water main testing and/or filling of new main.

The Contractor must have all materials, fittings, pumps and other miscellaneous equipment, and personnel on-site before the City of Ann Arbor Public Services personnel will prepare and shutdown and existing main.

The bedding and backfill for Trench Detail I (under roadbed), Modified, shall be MDOT Granular Material, Class II compacted to 95% of its maximum dry density in maximum lifts of 12 inches. The bedding and backfill for Trench Detail V (within 1:1 influence of the roadbed or curb and gutter), Modified, to a point 12 inches above the top of pipe, shall be MDOT Class II sand compacted to 95% of its maximum dry density. The material above this point shall be Engineer-approved native material compacted to 90% of its maximum dry density.

CITY OF ANN ARBOR  
DETAILED SPECIFICATION  
FOR  
**WATER MAIN AND APPURTENANCES**

AA:MGN  
AJK:

26 of 28

11/12/15  
Rev. 08/16/2022

The Contractor shall dig-up and expose all utility crossings prior to laying any water main pipe. This will allow the Engineer to adjust the grade of the water main, if possible, to avoid the existing utilities. The costs of the ‘dig-ups’, and all related costs, shall be included in the respective items of work in this Detailed Specification. Some “dig-ups” may need to occur out of Phase.

Should the water main, or other pay items in this Detailed Specification, conflict with abandoned sewers or water mains, the conflicting section of the abandoned sewer or water main shall be removed and the remaining sections shall be (re)abandoned in accordance the Detailed Specification for “Water Main and Appurtenances, Abandon” and the Detailed Specification for “Sewer, Any Size or Depth, Abandon,” except that flow filling the sewer will not be required. All the work shall be included in the cost of the water main, or other pay items in this Detailed Specification.

**e. Lighting Requirements for Nighttime Water Main Work.-** Night work shall be lighted to an average intensity of 10 foot-candles minimum. Sufficient light sources shall be provided to achieve this illumination requirement. The lighting scheme shall be submitted to the Engineer for review and approval a minimum of 72 hours prior to the anticipated commencement of the nighttime work. Nighttime work will not be allowed to begin until such time as the lighting scheme has been approved by the Engineer.

The lighting shall allow the inspector to clearly see and inspect all work operations. Light sources shall be adjusted as directed by the Engineer, as many times as needed, in order to meet the requirement.

Lighting systems may be fixed, portable, or equipment mounted. A power source shall be supplied with sufficient capacity to operate the lighting system. The power source shall not violate any local noise ordinance requirements. The lighting system(s) shall be arranged such that they do not interfere with the vision of motorists, glare or shine in the eyes of oncoming drivers, or unnecessarily illuminate surrounding properties or residences. After initial set-up, drive through and observe the lighted area from each direction on the roadway. Adjust lighting units as many times as needed in order to comply with these requirements.

**f. Sequence of Construction.-** All water main construction shall be completed in accordance with the Detailed Specification entitled “Maintaining Traffic”. The Contractor shall schedule and coordinate all water main shutdowns with the Engineer. The Contractor shall submit for the Engineer’s review and approval the sequence of all water main “shut

CITY OF ANN ARBOR  
DETAILED SPECIFICATION  
FOR  
**WATER MAIN AND APPURTENANCES**

AA:MGN  
AJK:

27 of 28

11/12/15  
Rev. 08/16/2022

downs” and tie-ins such that disruption in service to existing properties is minimized to the greatest extent possible. Should the Engineer not accept the Contractor’s proposed construction sequence, it shall not be a basis of claim for extension of contract time or additional compensation.

Abandon all water mains in accordance with the Detailed Specification for “Water Main and Appurtenances, Remove or Abandon” and the contract documents.

All water main and appurtenances shall be pressure tested, cleaned, disinfected and bacteriological tested in accordance with the specifications outlined within this Detailed Specification.

After acceptance of each section of new main the Contractor shall begin coordination with the City of Ann Arbor Public Services Area for the installation of water services, curb stops and boxes in accordance with the Detailed Specification entitled “Excavate and Backfill for Water Service Tap and Lead.”

CITY OF ANN ARBOR  
 DETAILED SPECIFICATION  
 FOR  
**WATER MAIN AND APPURTENANCES**

AA:MGN  
 AJK:

28 of 28

11/12/15  
 Rev. 08/16/2022

**g. Measurement and Payment.**- The completed work will be paid for at the contract unit prices for the following contract items (pay items):

<u>Contract Item (Pay Item)</u>	<u>Pay Unit</u>
CL 50, D.I. Water Main, w/ Poly Wrap, ___ inch, Tr Det I, Mod .....	Foot
___ deg Bend, ___ inch .....	Each
Reducer, ___ inch x ___ inch .....	Each
Cross, ___ inch x ___ inch.....	Each
Tee, ___ inch x ___ inch x ___ inch.....	Each
Fire Hydrant Assembly, with Extensions, Complete.....	Each
Gate Valve-in-Well, ___ inch .....	Each
Gate Valve-in-Box, ___ inch .....	Each
Sacrificial Anode, ___ Lb .....	Each

All work shall be paid in full at the contract unit prices which shall include all the labor, materials and equipment required including all required costs associated with night time work, supplemental lighting, and all other required elements of the work.

Fittings other than those specifically listed as separate contract items, blow-off assemblies, hoses, and restrained joint pipe and gaskets, special gaskets, and the like, shall not be paid for separately, but shall be considered included in the payment for “D.I. Water Main, w/Poly Wrap, \_\_\_ inch, Tr Det \_\_\_.”

Tees, Bends, and Reducers and other fittings specifically listed as separate contract items (pay items), shall be paid for at the contract unit price for each unit installed.

Valve Box Extensions will only be paid for if they are required by the plans and they are not required due to the Contractor’s operations.

“Sacrificial Anode, \_\_\_ lbs” shall include excavation, thermite welding anode lead to existing watermain, and backfilling excavation as specified.

DETAILED SPECIFICATION  
FOR  
**WATER MAIN AND APPURTENANCES, REMOVE OR ABANDON**

WTA:VCM  
AJK:

1 of 2

11/20/22

**a. Description.-** This work shall include abandoning or removing existing water mains, valves, valve wells, valve boxes, and fire hydrant assemblies of various sizes as required by the Plans. All work shall be performed in accordance with the project plans, as detailed in this Special Provision, and as directed by the Engineer.

**b. Materials.-** All materials shall meet the requirements specified in Division 9 and 10 of the MDOT 2020 Standard Specifications for Construction as follows:

Granular Material, Class II .....	Section 902
Masonry Units .....	Section 913
Mortar Type R-2 .....	Section 1005

Push-on joint plugs and thrust blocks shall conform to the requirements as detailed in the Detailed Specification on Water Main and Appurtenances.

**c. Methods of Construction.-** The Contractor shall abandon water mains where shown on the Plans and as directed by the Engineer. This includes, but is not limited to, cutting the main at each end, plugging the live main at the end(s) with push-on joint plug(s) and thrust block(s), plugging the abandoned main at its end(s) with brick and mortar, concrete, or mechanical joint plug, breaking down any manholes (remove manhole ring and cover and the top 4' of manhole structure, breaking out the manhole base, and backfilling as specified herein) in the abandoned line, removing and salvaging any valves and fittings, plugging the pipe in manholes with brick and mortar, concrete, or mechanical joint plugs.

In locations as shown on the Plans or where abandoned water main, valves or valve wells are within 30 inches of the proposed subgrade, the pipe, valves or valve wells shall be removed completely. The resulting hole or trench shall be backfilled with Granular Material, Class II, in maximum lifts of 12 inches, and be compacted to 95% of its maximum dry density, if located within the public rights-of-way, railroad rights-of-way, or within the influence of paved surfaces or structures. Applicable road pavement cross-section, per plans, shall be installed per plans and as directed by the Engineer. Otherwise, backfill shall be Engineer approved native material, compacted to 90% of its maximum dry density, in lifts of 12 inches or less, unless otherwise noted on the plans.

Abandoned (salvaged) or removed valves and fire hydrant assemblies shall be neatly stacked on-site in a single location so that City of Ann Arbor forces can retrieve them at a later date. The Contractor shall assist City forces by loading them into City trucks. All costs associated with storing, stockpiling, and loading valves and hydrants into City vehicles will not be paid for separately.

“Tapping Sleeve, Valve and Well, Remove” shall include removal of the tapping sleeve

and valve, reconnecting the ends of the two water mains, and abandoning the valve well.

**d. Measurement and Payment.-** The completed work as measured shall be paid at the contract unit prices for the following contract items (pay items):

<u>Contract Item (Pay Item)</u>	<u>Pay Unit</u>
Water Main, Abandon w/Flowable Fill.....	Linear Feet
Water Main Pipe Abandonment.....	Linear Feet
Gate Valve-in-Well, Rem .....	Each
Gate Valve-in-Box, Abandon .....	Each
Gate Valve-in-Well, Abandon .....	Each
Fire Hydrant, Remove.....	Each

“Water Main Pipe Abandonment” and ” Water Main, Abandon w/Flowable Fill” shall be measured and paid for by length in lineal feet and shall include all labor, materials, and equipment necessary to abandon or remove the pipe including, but not limited to; excavation; cutting of pipe; furnishing and installing push-on joint plugs and thrust blocks; constructing brick and mortar bulkheads; the furnishing, placement, and compaction of approved granular backfill material, as required; and, the removal and proper disposal off-site of excess materials.

“Gate Valve-in-Box, Abandon”, ”Gate Valve-in-Well, Remove”, “Gate Valve-in-Well, Abandon”, and “Fire Hydrant, Remove” shall be paid for at the contract unit price for each unit abandoned or removed.

Payment shall include all labor, materials, and equipment necessary to completely abandon or remove the valve, including removing and salvaging the valve, valve boxes, and manhole rings and covers. Also included is the removal of the top 4 feet of valve wells; breaking out the valve well base; furnishing, placement, and compaction of approved granular backfill material, as required; stockpiling valves for future City use or removal; and, the removal and disposal of excess materials. Payment for Fire Hydrant, Remove includes payment for abandoning the companion valve.



DETAILED SPECIFICATION  
FOR  
IRRIGATION AND WATER FOUNTAINS

1 of 7

11/11/2022

WTA:AJK

**a. Description**

This work shall be completed in accordance with the requirements and standards of the City of Ann Arbor, with the details as shown on the plans, and this detailed specification.

This work shall consist of furnishing all labor, tools, equipment, and material to install and test the irrigation meter pit, quick coupler assemblies, and salvage, store, and reinstall water fountains and fountain winterizing boxes and valves at locations as shown in the detail on the plans or otherwise approved by the Engineer.

**b. Submittal Requirements**

Shop Drawings and Equipment Product Information: Submit product information on all sprinklers, controllers, moisture sensors, hydrometers, enclosures, nozzles, swing joints, quick coupling valves, isolation valves, sleeving, control valves, wire conduit, PVC and polyethylene pipe, all pipe fittings, backflow preventer, copper pipe and fittings, wire, two-wire cable, decoders, surge arrestors, rain sensors, grounding rod, grounding plate, wire connectors, solvent and primer for PVC pipe, stainless steel clamps, and valve boxes to be used on the project.

Record Drawings and Instructions: Furnish record drawings showing actual location of all valves, drains, pipe, wiring and controls to scale with dimensions. In addition, submit two bound copies of an owner's manual, each containing operational sheets and parts lists covering all system components.

**c. Materials**

The Contractor shall furnish materials which meet the requirements specified by the City of Ann Arbor.

Tap, Meter, and Shut-Off Valve

The tap, meter, and the shut-off valve shall be furnished by the City of Ann Arbor.

Pipe, sleeves, and fittings

No substitutions of smaller pipe sizes may be allowed.

All pipe damaged or rejected because of defects shall be removed from the site at the time it is rejected.

DETAILED SPECIFICATION  
FOR  
**IRRIGATION AND WATER FOUNTAINS**

2 of 7

11/11/2022

WTA:AJK

Provide PVC pipe continuously and permanently marked with manufacturer's name or trademark, size, schedule, and working pressure at 73° F and National Sanitation Foundation (NSF) approval.

Saddle and cross fittings are not permitted. Use male adaptors for plastic to metal connections. Hand tighten male adaptors plus one turn with a strap wrench.

Refer to plans for PVC mainline and sleeving size and pipe type.

PVC pipe fittings shall be solvent weld, schedule 80 PVC.

All above grade pipe shall be hard copper. Fittings shall be cast brass or wrought copper.

#### Quicker Coupling Valves

Quick coupler valves shall be Rainbird 33DNP 3/4-inch with 33-DK key and SH-O male hose swivel.

Quick couplers shall have a one-piece body and stabilizer and a 36-inch re-rod to stabilize the quick coupler and to prevent movement during quick coupler activation.

Furnish four (4) valve keys with hose swivels to the City.

#### Meter Pit Box

**Irrigation Meter Pit:** The Contractor shall furnish an EJ 1730C-18 box with 1730 cover, which measures 21-1/4" x 34-1/8" x 18" BCF.

**Water Fountain Winterization:** The Contractor shall furnish an EJ 1118C-12 box with 1118 cover, which measures 11-7/16" x 18-1/8" x 12"BCF.

Meter pit boxes are to be a tapered enclosure of rigid plastic material comprised of chemically inert fibrous components and unaffected by moisture, corrosion, and temperature changes.

Meter pit boxes shall be of a minimum size required to permit access to the valve. Side walls to extend at least 2" below the bottom of valve body; use extension as necessary.

Meter pit boxes shall have rot proof landscape filter fabric liner 3/4" washed crushed stone sump.

DETAILED SPECIFICATION  
FOR  
**IRRIGATION AND WATER FOUNTAINS**

3 of 7

11/11/2022

WTA:AJK

Accessories

Drainage fill: 3/4" crushed stone to 6" below bottom of box. Fill shall be clean soil free of stones larger than 2" diameter, foreign matter, organic material, and debris. Provide imported fill material as required to complete the work. Obtain rights and pay all costs for imported materials.

Suitable excavated materials removed to accommodate the irrigation system work may be used as fill material subject to the Owner's review and acceptance.

Backflow Prevention Device

The Contractor shall furnish the backflow prevention device as specified by the City of Ann Arbor.

Water Fountain Mounting Hardware

The Contractor shall furnish new hardware to mount the water fountains which matches the existing in kind.

**d. Construction**

Job Conditions

Report to the Engineer any deviations between Drawings, Specifications, and the site. Failure to do so prior to the installation of equipment and which results in the replacement or relocation of equipment shall be at the Contractor's expense.

Acceptance

Prior to requesting inspections, adjust sprinkler heads, and automatic equipment to provide optimum performance. Submit accurate record drawings and operating instructions to the Engineer as a condition of final payment.

Examination

Examine final grades and installation conditions. Do not start irrigation system work until unsatisfactory conditions are corrected.

DETAILED SPECIFICATION  
FOR  
**IRRIGATION AND WATER FOUNTAINS**

4 of 7

11/11/2022

WTA:AJK

Excavating and Backfilling

The Contractor shall excavate and maintain trenches which provide safe and adequate working space for the City to install a tap, shut-off valve, and box at each location specified on the plans.

Excavate trenches of sufficient depth and width to permit proper handling and installation of pipe and fittings. Excavate to depths required to provide 2" depth of earth fill or sand bedding for piping when rock or other unsuitable bearing material is encountered.

Install sleeves for irrigation piping installed beneath paving. Minimum depth of bury for sleeves beneath roadways and drives to be 24" and 24" beneath walks.

Extend ends of all sleeves 12" beyond back of curbs or walk edges.

Fill to match adjacent grade elevation with approved earth fill material. Place and compact fill in layers not greater than 8" depth.

Provide approved fine-grained earth fill or sand to point 4" above the top of pipe, where soil conditions are rocky or otherwise objectionable.

Fill to within 6" of final grade with approved excavated or borrow fill materials free of lumps or rocks larger than 2" in any dimension.

The top 6" of backfill shall be topsoil, free of rocks, subsoil or trash. Any special soil mixture shall be replaced to the original condition it was prior to irrigation installation.

Except as indicated, install irrigation mainline with a minimum cover of 24" based on finished grades. Install irrigation laterals with a minimum cover of 12" based on finished grades.

Excavate trenches and install piping and backfill during the same working day. Do not leave open trenches or partially filled trenches open overnight.

It shall be the Contractor's sole responsibility to backfill all trenches.

Plastic Underground Pipe:

Install all plastic pipe in accordance with manufacturer's installation instructions as ASTM D- 2274. Provide for thermal expansion and contraction.

DETAILED SPECIFICATION  
FOR  
**IRRIGATION AND WATER FOUNTAINS**

5 of 7

11/11/2022

WTA:AJK

Saw cut plastic pipe. Use a square-in-sawing vice, to ensure a square cut. Remove burrs and shavings at cut ends prior to installation.

Make PVC plastic-to-plastic joints with solvent weld joints. Use only primer and solvent recommended by the pipe manufacturer. Install plastic fittings in accordance with pipe manufacturer's instructions and ASTM D-2855.

Allow joints to set at least 24 hours before pressure is applied to the system.

Maintain pipe interiors free of dirt and debris. Close open ends of pipe by capping, taping or other acceptable method when pipe installation is not in progress.

Taps and Shut-off Valves and Boxes

The City shall install all taps and shut-off valves and boxes after the Contractor has made excavation areas ready.

Water Fountain Removal and Storage

The Contractor shall shut off, disconnect, remove, clean, transport, and securely store water fountains in advance of other removal operations.

Irrigation System and Water Fountain Installation

After the City has installed the tap and shut-off valve and box, the Contractor shall install the winterization air compressor attachment ball valve and box for irrigation systems and water fountains.

The Contractor shall install the meter pit, quick coupler, and pipe for irrigation systems.

The Contractor shall install water fountains with new hardware and connect them to City installed water service leads. This will require the Contractor to furnish and install pipe.

Meter

The City shall install the meter.

The Contractor shall provide all fittings and pipe necessary for the City to install the meter.

DETAILED SPECIFICATION  
FOR  
**IRRIGATION AND WATER FOUNTAINS**

6 of 7

11/11/2022

WTA:AJK

Flushing and Testing 6. Flushing and Testing

After all new quick couplers are in place and connected for a given section and all necessary division work has been completed, quick couplers shall be opened and a full head of water used to flush out the system.

Sprinkler mains shall be tested under normal water pressure for a period of 12 hours. If leaks occur, repair and repeat the test. Give Owner 24-hour notice prior to testing.

Testing of the system shall be performed after completion of each section or completion of the entire installation; and any necessary repairs shall be made, at the Contractor's expense, to put the system in good working order before final payment by the Owner.

Adjustment of the equipment will be done by the Contractor upon completion of installation to provide optimum performance.

Clean Up

The Contractor shall keep the premises free from rubbish and debris at all times and shall arrange his material storage so as not to interfere with the Owner's operation of the job. Contractor shall remove and legally dispose of all unused material, rubbish and debris, including unsuitable excavated material from the site.

**e. Measurement and Payment**

The tap, valve, service lead up to the winterization connection, and meters will be provided and installed by the City of Ann Arbor for irrigation systems and water fountains.

Excavation by the Contractor for the City portion of the work shall be paid for separately as Excavate and Backfill for Water Service Tap and Lead – Ft.

Irrigation and Water Fountains shall be paid for at the contract unit price on each basis. The contract unit price shall consist of supplying and installing all irrigation components specified herein and shown on the drawings, including all submittals, permits, excavation and properly compacted backfill, and other work incidental to complete installation of a fully operational system.

The work completed and measured for Irrigation and Water Fountains shall be paid for at the contract unit price for the following pay items:

DETAILED SPECIFICATION  
FOR  
IRRIGATION AND WATER FOUNTAINS

7 of 7

11/11/2022

WTA:AJK

<b><u>Contract Item (Pay Item)</u></b>	<b><u>Unit</u></b>
Meter Pit, Complete .....	Each
Water Fountain, Salv, Rem .....	Each
Water Fountain, Salv, Install.....	Each
Water Fountain, Winterization Box, Complete.....	Each

Removing, disconnecting, cleaning, transporting, and storing water fountains shall not be paid for separately, but shall be included in payment for Water Fountain, Salv, Rem.

Installing water fountains and connecting them to water services shall not be paid for separately, but shall be included in payment for Water Fountain, Salv, Install.

Payment for excavation and furnishing and installing all boxes, hardware, valves, pipe, fabric, aggregate, and supports shall be considered included in payment for the corresponding pay items.

The Contractor shall not be due compensation for delays caused by the City or their representatives.

The unit price for these items of work shall include all labor, material, and equipment costs to perform all the work.

DETAILED SPECIFICATION  
FOR  
**STORM SEWER, MODIFIED**

AA:MGN  
WT:VCM:CGT:AJK

1 of 9

02/13/14  
11/21/22

**a. Description.-** This work shall consist of installing storm sewer in accordance with Section 402 of the Michigan Department of Transportation 2020 Standard Specifications for Construction and as specified herein. All newly constructed storm sewer shall be tested and video inspected in accordance with the requirements of this Detailed Specification.

**b. Materials.-** The materials used for this work shall be in accordance with Section 402.02 except as modified herein.

Bedding and backfill for Trench Detail I, Modified shall be Granular Material, Class II, meeting the requirements of Section 902. Bedding and backfill for Trench Detail V, Modified shall be Granular Material, Class II and Engineer-approved material for the backfill that is placed at an elevation greater than 1-foot above the top-of-pipe and/or outside the 1:1 influence line of paved areas.

All pipe shall be concrete, contain steel reinforcement, and shall be of the type, class, and size as shown on the plans.

Reinforced concrete pipe shall conform to the requirements for reinforced concrete pipe of ASTM Designation C 76, Class IV, unless otherwise designated on the Plans. For diameters larger than listed in ASTM Specifications, wall thickness and reinforcing steel shall be as shown in Section 909 Table 909-3 or 909-4 as applicable.

Reinforced elliptical concrete pipe shall conform to the requirements for reinforced concrete elliptical pipe of ASTM Designation C 507, Class as designated on the Plans. For diameters larger than listed in ASTM Specifications, wall thickness and reinforced steel shall be as shown in Section 909 Table 909-5.

Joints for reinforced concrete pipe shall meet ASTM C 443 and shall be rubber gasket for tongue and groove, full bell and spigot rubber O-ring gasket, or modified grooved tongue with rubber gasket. Joints for sewers over 36 inches in diameter shall have inside joints cement mortar pointed to their full depth and shall have the outside joints provided with a cement mortar collar.

Joints for reinforced concrete elliptical pipe shall be mastic compound with inside cement mortar pointing to full depth and outside cement mortar collar.

Lubricants used in making up joints shall be supplied by the pipe manufacturer and the joints shall be coupled in accordance with the manufacturer's requirements.



DETAILED SPECIFICATION  
FOR  
**STORM SEWER, MODIFIED**

AA:MGN  
WT:VCM:CGT:AJK

2 of 9

02/13/14  
11/21/22

Class X concrete as described in this Detailed Specification shall consist of Portland Cement, coarse and fine aggregates, and water, proportioned with 282 lbs. cement (3 sacks) per cubic yard to produce a minimum 28 day compressive strength of 1000 psi.

**c. Pipe Inspection and Delivery.-** The following information shall be clearly marked on each length of pipe:

- a) The pipe designation and class (e.g., C 76, Class IV).
- b) The name or trademark of the manufacturer.
- c) Identification of the manufacturing plant.
- d) The date of manufacture.
- e) Testing lot number or testing lab stamp.
- f) Reinforced concrete pipe with elliptical reinforcement shall be clearly marked on the inside and the outside opposite walls along the minor axes of the elliptical reinforcing.
- g) Beveled pipe shall be marked with the amount of bevel and the point of maximum length shall be marked on the beveled end.

All pipe furnished shall be subject to inspection on arrival at the job site by the Engineer. The purpose of the inspection shall be to cull and reject pipe or fittings that, independent of physical tests specified under the standard specifications designated herein, fail to conform to the requirements of these Specifications.

The Contractor shall notify the Engineer sufficiently in advance so that an Inspector may be on the job during the unloading of materials. A minimum notice of 24 hours is required for such unloading and inspection.

Concrete pipe of any type shall be subject to rejection on account of any of the following:

- a) Variation in any dimension exceeding the permissible variations given in the material specifications.
- b) Fractures or cracks passing through the wall.
- c) Defects that indicate imperfect proportioning, mixing, or molding.
- d) Surface defects indicating honeycombed or open texture.
- e) Variation of more than 1/16 inch per lineal foot in alignment of pipe intended to be straight.
- f) Insecure attachment of branches or spurs.

DETAILED SPECIFICATION  
FOR  
**STORM SEWER, MODIFIED**

AA:MGN  
WT:VCM:CGT:AJK

3 of 9

02/13/14  
11/21/22

- g) Damaged ends, where in the judgment of the Engineer such damage would prevent making a satisfactory joint.

Rejected pipe shall be plainly marked by the Inspector and immediately removed from the site of the work by the Contractor without cost to the project.

All pipe furnished shall be accompanied by the manufacturer's certificate of test showing conformity with the Specifications. Each certificate shall identify a specific lot number, quantity of pipe, and show actual test results for the lot furnished. These certificates shall be submitted to the Inspector at the time of unloading.

**d. Methods of Construction.-** All construction shall be performed in accordance with Section 402.03 except as modified herein.

The bedding and backfill for Trench Detail I, Modified shall be MDOT Class II sand compacted to 95% of its maximum dry density. Compaction shall be performed as specified elsewhere in this Detailed Specification.

The bedding and backfill for Trench Detail V, Modified to a point 12 inches above the top of pipe, shall be MDOT Class II granular material compacted to 95% of its maximum dry density. The backfill above a point 12 inches above the top of pipe shall be Engineer-approved material, compacted to 90% of its maximum dry density. Compaction shall be performed as specified elsewhere in this Detailed Specification.

The Contractor shall proceed with caution in the excavation and preparation of the trench so that the exact location of underground structures, both known and unknown, may be determined, and the Contractor shall be held responsible for the repair of such structures when broken or otherwise damaged. The Contractor shall not intentionally remove existing storm sewer, storm sewer leads, or sanitary sewer leads in lieu of protecting and preserving them in order to expedite the proposed construction.

Excavation normally shall be by open cut from the surface, except as otherwise specified, or in special cases where crossing under trees, pavements, or structures. The Contractor may use tunnel methods if permitted in writing by the Engineer, provided his method of backfill is such, in the judgment of the Engineer, as to avoid any present or future injury to the tree, pavement, or structure. All excavation shall be in such manner as will provide adequate room for the construction and installation of the work to the lines, grades and dimensions shown on the Plans.

DETAILED SPECIFICATION  
FOR  
**STORM SEWER, MODIFIED**

AA:MGN  
WT:VCM:CGT:AJK

4 of 9

02/13/14  
11/21/22

The trench shall be excavated to a minimum of four inches below the final location of the pipe. For reinforced concrete pipe 66" in diameter or larger, the trench will be excavated to a minimum of six inches below the pipe. This cut shall be filled to the level of the bottom quadrant of the pipe with Class II granular material as specified herein, shaped and compacted to the pipe barrel.

Bell holes shall be provided in the trench bottom at each joint to permit the joints to be made properly.

The Contractor shall dig-up and expose all utility crossings prior to laying any storm sewer pipe. This will allow the Engineer to adjust the grade of the storm sewer, if possible, to avoid the existing utilities. The costs of the exploratory excavation, and all related costs, shall be included in the unit price of the storm sewer. The Engineer may require that some dig-ups be performed out of the current construction stage or phase where the sewer work is taking place in order to aid in alignment decisions. Any required traffic control measures required to comply with this requirement shall be included in the costs of "Minor Traf Devices" and "Traffic Regulator Control."

During the construction it may be necessary to cross under or over certain sewers, drains, culverts, water lines, gas lines, electric lines, and other underground structures or facilities, known or unknown. The Contractor shall make every effort to prevent damage to such underground structures and facilities. Wherever such structures or facilities are disturbed or broken, they shall be restored to a condition that is as good, or better than, that which existed prior to the disturbance and shall be acceptable to the owner and the City, at the Contractor's expense. These crossings shall be made with a minimum of twelve inches of vertical clearance between facilities.

Should the storm sewer conflict with abandoned sewers or water mains, the conflicting section of abandoned sewer or water main shall be removed and the remaining sections shall be (re)abandoned in accordance the Detailed Specification for "Water Main and Appurtenances, Abandon" and the Detailed Specification for "Sewer, Any Size or Depth, Abandon," except that flow filling the sewer will not be required. All the abandonment work shall be included in the cost of the storm sewer and will not be paid for separately.

Not more than 50 feet of trench shall be open at one time in advance of the pipe laying operation. At no time shall more than 200 feet of trench be opened and incompletely backfilled. At the end of each day, no more than 25 feet of trench may be left open, and access to all drives shall be restored. This opening shall be surrounded

DETAILED SPECIFICATION  
FOR  
**STORM SEWER, MODIFIED**

AA:MGN  
WT:VCM:CGT:AJK

5 of 9

02/13/14  
11/21/22

by fencing and barricades, or plated. The remainder of the trenching operation shall be available for safe vehicular and pedestrian traffic at all times.

All excavated material approved by the Engineer as backfill material and imported backfill material shall be piled in a manner that will not endanger the work and that will avoid obstructing sidewalks and driveways. All excavated material which is unsuitable for backfill shall be immediately removed from the site by the Contractor unless otherwise provided in the contract documents. Hydrants under pressure, manholes of any kind, valve boxes, curb stop boxes, fire and police call boxes, and other utility controls shall be left unobstructed and accessible until the work is completed. Gutters shall be kept clear, or other satisfactory provisions made, for street drainage, and natural water courses shall not be obstructed.

Each pipe shall be inspected for defects prior to being lowered into the trench. Inside of pipe and outside of spigot shall be cleaned of any earth or foreign matter.

Proper implements, tools, and facilities satisfactory to the Engineer shall be provided and used by the Contractor for the safe and convenient prosecution of the work. All pipe, manhole bases, manhole sections, and other similar items shall be carefully lowered into the trench piece by piece by means of suitable tools or equipment as recommended by the manufacturer, in such a manner as to prevent damage to them and their protective coatings and linings. Under no circumstances shall materials be dropped or dumped into the trench.

Construction of sewers shall begin at the outlet end and proceed upgrade. Pipe shall be laid on the prepared subgrade with the bell ends facing the direction of laying, unless otherwise directed by the Engineer.

The Contractor shall take every precaution to prevent foreign material from entering the pipe while it is being placed in the line. During laying operations, no debris, tools, clothing or other materials shall be placed in the pipe. At times when pipe laying is not in progress, the open ends of pipe shall be closed by a watertight plug. This provision shall apply during the noon hours as well as overnight. If water is in the trench, the seal shall remain in place until the trench is pumped completely dry.

Pipe shall be jointed as specified elsewhere herein.

No pipe shall be laid until a cut sheet for that pipe has been approved by the Engineer. All pipe shall be laid at the correct line and grade as indicated by the grade stakes and offset line. The correct line and grade shall be maintained by the use of a

DETAILED SPECIFICATION  
FOR  
**STORM SEWER, MODIFIED**

AA:MGN  
WT:VCM:CGT:AJK

6 of 9

02/13/14  
11/21/22

laser alignment system. Each pipe, as laid, shall be checked by the Contractor to insure that this result is obtained. The grade as shown on the Plans is that of the pipe invert for sewers and the work must conform to this profile. A variation of 1/4 inch from this profile grade will be deemed sufficient reason to cause the work to be rejected and relaid. Sewer pipe alignment shall be maintained so as to not vary more than one-half inch from the correct line on pipes up to 36 inches in diameter nor more than one inch on pipes 42 inches in diameter and larger. Any pipe found out of line shall be relaid properly by the Contractor.

Mechanical means shall be used for pulling home all rubber-gasketed pipe regardless of trench condition where manual means will not result in pushing and holding the pipe home. When a trench box or liner is used, a cable shall be used to pull the joints home and hold them in position.

Where work is performed in wet trenches or trenches with running sand, the Contractor shall provide and use mechanical means for pulling the pipe home in making up the joint and for holding the pipe joints tight until completion of the line. Mechanical means shall consist of a cable placed inside or outside of the pipe with a suitable winch, jack, or come-along for pulling the pipe home and holding the pipe in position.

Where not required by these Specifications, manual means will be acceptable only if the joints can be pushed home and hold themselves securely in place.

All pipes shall be bed on a four inch or thicker layer of compacted Class II granular material (unless noted otherwise on the applicable trench details) unless pipe undercutting is required. Perform any required pipe undercutting as directed by the Engineer and in accordance with the Section 402.03.A.

Where Class II granular material used as pipe bedding is required by the plans, from the bedding to the pipe centerline backfill shall be carefully placed Class II granular material, placed in maximum lift thicknesses of six inches, loose measure. Each lift shall be thoroughly compacted by hand tamps, pneumatic "pogo-sticks", or other approved methods, to at least 95% of the material's maximum dry density at optimum moisture content. Each lift shall extend the full width of the space between the pipe and trench wall, and the fill shall be brought up evenly on both sides of the pipe. The backfill under the haunches of the pipe shall be consolidated by the use of a tee-bar.

When the pipe is greater than 48 inch diameter, or when permitted in writing by the Engineer, the Class II granular fill from the bedding to the centerline may be replaced by 6A, 17A, or 34R aggregate meeting the requirements of Section 902. A suitable

DETAILED SPECIFICATION  
FOR  
**STORM SEWER, MODIFIED**

AA:MGN  
WT:VCM:CGT:AJK

7 of 9

02/13/14  
11/21/22

geotextile separator, approved by the Engineer, shall be provided around and above the coarse aggregate to prevent intrusion of succeeding backfill materials.

Where Class II granular material used as pipe bedding is required by the plans, from the pipe centerline to the top of the pipe, backfill shall be Class II granular material placed in maximum lift thicknesses of six inches, loose measure. Each lift shall be thoroughly compacted by hand tamps, pneumatic "pogo-sticks", or other approved methods, to at least 95% of the material's maximum dry density.

From the top of the pipe to two feet above the top of the pipe backfill shall be Class II granular material uniformly spread and machine tamped. Machine tamping shall include manually operated vibrating plate compactors. The backfill material shall be compacted in lifts of twelve inches, loose measure.

From two feet above the top of the pipe to the grade shown on the Plans or to the subgrade of surface materials, or to the subgrade of surface structures, backfill shall be Class II granular material (Trench Detail I installations) uniformly spread and machine tamped. If machine tamping includes manually operated vibrating plate compactors or self propelled vibrating rollers the backfill material shall be compacted in lifts not exceeding twelve inches, loose measure. If a backhoe mounted compactor is employed, the backfill material shall be compacted in lifts of thirty-six inches, loose measure. Approval to use a particular machine tamping method will be withdrawn by the Engineer if the method causes injury to the pipe or adjacent structures or movement of the pipe. Each lift shall be thoroughly compacted to at least 95% of material's maximum dry density. The Engineer may give consideration to giving written permission to increase the thickness of the lifts specified in this paragraph if satisfactory compaction is achieved and no undesirable side effects occur.

From one foot above the top of the pipe to the grade shown on the Plans or to the subgrade of surface materials, or to the subgrade of surface structures, backfill shall be Engineer-approved material (Trench Detail V installations) uniformly spread and machine tamped. If machine tamping includes manually operated vibrating plate compactors or self propelled vibrating rollers the backfill material shall be compacted in lifts not exceeding twelve inches, loose measure. If a backhoe mounted compactor is employed, the backfill material shall be compacted in lifts of thirty-six inches, loose measure. Approval to use a particular machine tamping method will be withdrawn by the Engineer if the method causes injury to the pipe or adjacent structures or movement of the pipe. Each lift shall be thoroughly compacted to at least 90% of the material's maximum dry density.

DETAILED SPECIFICATION  
FOR  
**STORM SEWER, MODIFIED**

AA:MGN  
WT:VCM:CGT:AJK

8 of 9

02/13/14  
11/21/22

All storm sewer shall be television inspected by the Contractor. The Contractor shall furnish all labor, equipment and materials necessary for the television inspection. The Engineer shall be given 24 hours notice so that an Inspector may witness the television inspection. All storm sewer lines are to be thoroughly cleaned prior to television inspection, by jetting of the lines or other approved methods. Television inspection shall consist of wetting the invert of the section by pouring clean water in the upstream manhole until it appears in the downstream manhole, and then, after the water has stopped flowing, passing a television camera through the section. The television camera shall be passed through the section of pipe from the downstream to upstream end. Any runs of sewer not televised in this manner shall be re-televised at the Contractor's expense. The camera shall be connected to a monitor and a digital video recorder capable of generating DVD format disks. The video inspection record shall indicate the date, the section tested, and the actual distance from the beginning manhole to the ending manhole and shall note each visible defect. The DVD shall be furnished to the Engineer for review.

The television inspection will be deemed satisfactory if no visible defects, including, but not limited to, dips or low spots, high spots, errors in horizontal or vertical alignment, joint offsets, leaks, cracks, standing water greater than  $\frac{1}{4}$ " , or debris, are present. Only after all tests have been successfully completed, and acknowledged by the Engineer in writing, may the storm sewer be placed into service.

If a sewer repair is required as a result of damage during construction operations or television inspection failure, the Contractor shall expose the sewer pipe and perform the required correction(s), as specified herein and as directed by the Engineer.

If the repair is required due to the pipe being out of alignment or off grade, the pipe shall be adjusted so as to be placed in proper alignment and grade. Coarse-graded aggregate material shall be carefully placed under the haunches of the realigned pipe and compacted by the use of a tee-bar. From the haunches of the pipe, backfilling shall be performed in accordance with the requirements for backfilling as outlined elsewhere in this Detailed Specification.

If the pipe cannot be satisfactorily realigned or an open joint reset; or if the pipe is cracked, broken, or permanently deflected, the affected pipe shall be removed and replaced with the same pipe material. The pipe to be removed is to be sawed on each side of the damaged section in a neat and workmanlike manner without damage to the adjacent pipe. The replacement pipe section shall fit flush to the remaining pipe at each end. These sawed joints shall be coupled using a flexible pipe coupling and stainless steel shear ring. These joints shall be encased to the pipe centerline with Class X

DETAILED SPECIFICATION  
FOR  
**STORM SEWER, MODIFIED**

AA:MGN  
WT:VCM:CGT:AJK

9 of 9

02/13/14  
11/21/22

concrete one foot on either side of the flexible coupling. The remaining pipe backfill shall be performed in accordance with the applicable requirements for backfilling as outlined elsewhere in this Detailed Specification.

**e. Measurement and Payment.-** The completed work as measured will be paid for at the contract unit prices for the following contract items (pay items):

<u><b>Contract Item (Pay Item)</b></u>	<u><b>Pay Unit</b></u>
RCP, Sewer, C76, CL-IV, __inch, Tr Det I .....	Foot

The items of work listed above shall be paid for by the length of pipe actually installed. The unit price for this item of work shall include all labor, material, and equipment costs, including video inspection, and all needed items to properly complete the work as shown on the plans, as detailed in the Specifications, and as directed by the Engineer.

The herein specified dig-ups shall be included in the cost of the pipe and not paid for separately.



DETAILED SPECIFICATION  
FOR  
**SANITARY SEWER**

AA:MGN  
WT:VCM:CGT:AJK

1 of 25

04/08/14  
11/21/22

**a. Description.** This work includes installing sanitary sewer, manholes and related items. The Contractor shall furnish all materials, equipment, tools, and labor necessary to perform the work required by this Detailed Specification and shall unload, haul, distribute, store, and install all pipe, fittings, castings, manholes, and accessories.

The Contractor shall excavate all trenches and pits to the required dimensions; excavate the bell holes; sheet, brace, and properly support the adjoining ground or structures where necessary to comply with MIOSHA and other relevant safety standards; properly handle and remove all drainage or ground water so that the work can be completed in accordance with the specifications; install and test the pipe, fittings, castings, manholes, and accessories; backfill and compact all fill materials within trenches and pits; and remove and properly dispose of surplus or unsuitable excavated material off-site.

**Materials.** Materials shall conform to the Michigan Department of Transportation 2020 Standard Specifications for Construction, Sections:

Concrete, Grade 3500 .....	1004
Mortar, Type R-1 .....	1005
Granular Material, Class II .....	902
Coarse Aggregate, 6A .....	902
Steel Reinforcement .....	905
Castings .....	908
Miscellaneous Metal Products .....	908
Geosynthetics .....	910
Masonry Units .....	913

Coarse Aggregate, 6A shall be crushed limestone. Concrete, Grade X shall consist of Portland cement, coarse and fine aggregates, and water, proportioned with 282 lbs. cement (3 sacks) per cubic yard to produce a minimum 28 day compressive strength of 1000 psi.

Vitrified Clay Pipe and Fittings:

Vitrified clay sewer pipe shall be the bell and spigot type, glazed or non-glazed, and shall be of full internal diameter from 4 through 18 inches inclusive. Clay pipe shall conform to the material and testing requirements of ASTM C 700, extra strength.

DETAILED SPECIFICATION  
FOR  
**SANITARY SEWER**

AA:MGN  
WT:VCM:CGT:AJK

2 of 25

04/08/14  
11/21/22

**Joints:**

Joints for vitrified clay sewer pipe shall be compression type joints conforming to the material and testing requirements of ASTM C 425. Lubricant used in making up joints shall be supplied by the pipe manufacturer and the joints shall be coupled in accordance with the manufacturer's requirements.

**Pipe Marking:**

The following information shall be clearly marked on each length of pipe:

- a) The pipe designation and class (e.g., C 700, ES).
- b) The name or trademark of the manufacturer.
- c) Identification of the manufacturing plant.
- d) Testing lot number or testing lab stamp.

**Manufacturer's Certification:**

All pipe furnished shall be accompanied by the manufacturer's certificate of test showing conformity with the Specifications. Each certificate shall identify a specific lot number, quantity of pipe, and show actual test results for the lot furnished. These certificates shall be submitted to the Inspector at the time of unloading.

**Inspection:**

All pipe furnished shall be subject to inspection on arrival at the job site by the Engineer. The purpose of the inspection shall be to cull and reject pipe or fittings that, independent of physical tests specified under the standard specifications designated herein, fail to conform to the requirements of these Specifications.

The Contractor shall notify the Engineer sufficiently in advance so that an Inspector may be on the job during the unloading of materials. A minimum notice of 24 hours is required for such unloading and inspection.

Vitrified clay pipe shall be subject to rejection on account of any of the following:

- a) Variation in any dimension exceeding the permissible variations given in the material specifications. Pipe in all cases shall be full diameter.
- b) Fractures or cracks passing through the barrel or socket.
- c) Chips or fractures on the interior of the pipe exceeding two inches in length, one inch in width, or depth more than 1/4 of the thickness of the wall.
- d) Blisters that are either broken, exceed three inches in diameter, or project more

DETAILED SPECIFICATION  
FOR  
**SANITARY SEWER**

AA:MGN  
WT:VCM:CGT:AJK

3 of 25

04/08/14  
11/21/22

- than 1/8-inch above the surrounding surface of the pipe.
- e) Variation of more than 1/16-inch per lineal foot in alignment of pipe intended to be straight.
  - f) Insecure attachment of branches or spurs.

Rejected pipe shall be plainly marked by the Inspector and immediately removed from the site of the work by the Contractor, without cost to the City.

Polyvinyl Chloride Pipe and Fittings:

Polyvinyl chloride (PVC) pipe shall have an integral wall bell and spigot. PVC pipe shall conform to the material and testing requirements of ASTM D 3034-83. Minimum wall thickness shall be SDR 35.

Joints:

Joints for PVC pipe shall be elastomeric gasketed push-on joints conforming to the requirements of ASTM D 3212-81. Lubricant used in making up joints shall be supplied by the pipe manufacturer and the joints shall be coupled in accordance with the manufacturer's requirements.

Pipe Marking:

The following information shall be clearly marked on each length of pipe at intervals of five feet or less:

- a) Manufacturer's name or trademark and code.
- b) Nominal pipe size.
- c) The PVC cell classification (e.g. "12454-B").
- d) The legend "Type PSM SDR-35 PVC Sewer Pipe".
- e) The designation "Specification D 3034".

The following information shall be clearly marked on each fitting:

- a) Manufacturer's name or trademark and code.
- b) Manufacturer's name or trademark.
- c) Nominal size.
- d) The material designation "PVC".
- e) "PSM"
- f) The designation "Specification D 3034".

Manufacturer's Certification:

DETAILED SPECIFICATION  
FOR  
**SANITARY SEWER**

AA:MGN  
WT:VCM:CGT:AJK

4 of 25

04/08/14  
11/21/22

All pipe furnished shall be accompanied by the manufacturer's certificate of test showing conformity with the Specifications. Each certificate shall identify a specific lot number, quantity of pipe, and show actual test results for the lot furnished. These certificates shall be submitted to the Inspector at the time of unloading.

Inspection:

All pipe furnished shall be subject to inspection on arrival at the job site by the Engineer. The purpose of the inspection shall be to cull and reject pipe or fittings that, independent of physical tests specified under the standard specifications designated herein, fail to conform to the requirements of these Specifications.

The Contractor shall notify the Engineer sufficiently in advance so that an Inspector may be on the job during the unloading of materials. A minimum notice of 24 hours is required for such unloading and inspection.

Pipe shall be subject to rejection on account of any of the following:

- a) Variation in any dimension exceeding the permissible variations given in the material specifications. Pipe in all cases shall be full diameter.
- b) Fractures or cracks passing through the barrel or socket.
- c) Chips or fractures on the interior of the pipe exceeding two inches in length, one inch in width, or depth more than 1/4 of the thickness of the wall.
- d) Blisters that are either broken, exceed three inches in diameter, or project more than 1/8-inch above the surrounding surface of the pipe.
- e) Variation of more than 1/16-inch per lineal foot in alignment of pipe intended to be straight.

Rejected pipe shall be plainly marked by the Inspector and immediately removed from the site of the work by the Contractor, without cost to the City.

Sewer Service Leads, Risers and Fittings:

Allowable pipe materials are; SDR 35 polyvinyl chloride (PVC) plastic conforming to the material and testing requirements of ASTM D 3034; and vitrified clay pipe conforming to the material and testing requirements of ASTM C 700.

Whenever adapters are required to properly connect the pipe with pipe of other material or manufacturer, the nominal I.D. of adapters shall be manufactured for that specific purpose and shall be the same size as the nominal diameter of pipe connected thereto. Adapters shall also be furnished and used as required by the manufacturer. The adaptor at this

DETAILED SPECIFICATION  
FOR  
**SANITARY SEWER**

AA:MGN  
WT:VCM:CGT:AJK

5 of 25

04/08/14  
11/21/22

tapped connection shall be made using either a gasketed sewer saddle, a flexible neoprene rubber boot, or approved equal. Gasketed sewer saddles shall meet the following requirements:

- a) The castings shall be ductile iron per ASTM 536, Grade 65-45-12, protected with a yellow shopcoat.
- b) The adjustable strap shall be 3.5" wide, stainless steel per ASTM A 240, type 304.
- c) The bolts shall be 0.5" UNC rolled thread, lubricant coated, stainless steel per ASTM A 1943, type 304.
- d) The nuts shall be per ASTM A 194, type 304.
- e) The washers shall be stainless steel per ASTM A 240, type 304 and plastic lubricating washers.
- f) The gaskets shall be SBR per ASTM D 2000 MBA 710, compounded for water and sewer service.

**Joints:**

Joints for SDR 35 PVC pipe shall be bell and spigot rubber o-ring gasket joints conforming to the requirements of ASTM D-3212. Lubricant supplied by the pipe manufacturer shall be used, and the joints shall be coupled in accordance with the manufacturer's requirements.

Joints for vitrified clay pipe shall be compression type joints conforming to the material and testing requirements of ASTM C 425. Lubricant used in making up joints shall be supplied by the pipe manufacturer and the joints shall be coupled in accordance with the manufacturer's requirements.

Joints for cast iron pipe shall be mechanical compression joints conforming to the material and testing requirements of ASTM C 564.

**Pipe Marking:**

The following information shall be clearly marked on each length of pipe:

- a) The pipe designation and class (e.g., SDR 35, ASTM D 3034).
- b) The name or trademark of the manufacturer.
- c) Identification of the manufacturing plant.
- d) Testing lot number.

**Manufacturer's Certification:**

All pipe furnished shall be accompanied by the manufacturer's certificate of test showing

DETAILED SPECIFICATION  
FOR  
**SANITARY SEWER**

AA:MGN  
WT:VCM:CGT:AJK

6 of 25

04/08/14  
11/21/22

conformity with the Specifications. Each certificate shall identify a specific lot number, quantity of pipe, and show actual test results for the lot furnished. These certificates shall be submitted to the Inspector at the time of unloading.

**Inspection:**

All pipe furnished shall be subject to inspection on arrival at the job site by the Engineer. The purpose of the inspection shall be to cull and reject pipe or fittings that, independent of physical tests specified under the standard specifications designated herein, fail to conform to the requirements of these Specifications.

The Contractor shall notify the Engineer sufficiently in advance so that an Inspector may be on the job during the unloading of materials. A minimum notice of 24 hours is required for such unloading and inspection.

Pipe for sewer service leads and risers shall be subject to rejection on account of any of the following:

- a) Variation in any dimension exceeding the permissible variations given in the material specifications. Pipe in all cases shall be full diameter.
- b) Fractures or cracks passing through the barrel or socket.
- c) Chips or fractures on the interior of the pipe exceeding two inches in length, one inch in width, or depth more than 1/4 of the thickness of the wall.
- d) Blisters that are either broken, exceed three inches in diameter, or project more than 1/8-inch above the surrounding surface of the pipe.
- e) Variation of more than 1/16-inch per lineal foot in alignment of pipe intended to be straight.

Rejected pipe shall be plainly marked by the Inspector and immediately removed from the site of the work by the Contractor, without cost to the City.

**Manholes:**

All sanitary sewer manholes shall be constructed of precast reinforced concrete sections. Precast drainage structures shall be designed to accommodate HL-93 Modified Live Load requirements as determined by a Professional Engineer licensed by the State of Michigan, regardless of where they are to be installed. For the purposes of design, a HL-93 Modified Live Load shall consist of 1.2 times the design truck or 1.2 times a single 60 kip load, whichever produces the greater stresses.

Precast reinforced concrete bases, bottom sections, manhole risers, grade adjustment rings, concentric cones, eccentric cones, and flat top slabs shall conform to the

DETAILED SPECIFICATION  
FOR  
**SANITARY SEWER**

AA:MGN  
WT:VCM:CGT:AJK

7 of 25

04/08/14  
11/21/22

requirements of ASTM C 478. Joints on precast manholes used on all sanitary sewers shall meet ASTM C 443, rubber O-ring gasket.

Concrete brick shall conform to the requirements for concrete building brick, ASTM C 55, Grade N-1.

Cast iron frames and covers for manholes shall conform to the requirements for grey iron castings, ASTM A 48, Class No. 30. Specific, approved castings are listed in the Detailed Specification for "Dr Structure Covers."

Plastic coated manhole steps shall be injection molded of copolymer, polypropylene, encapsulating a 1/2 inch grade 60 steel reinforcing bar. Plastic-coated manhole steps shall meet the performance test described in ASTM C-478, Paragraph II, and shall have an impact resistance of 300 ft.-lbs., with only minor deflection and no cracking or breaking.

The steps shall resist pull out forces of 1500 lbs.

**Manhole Connections:**

Sewer pipe to precast manhole connections shall be through: 1) a flexible neoprene rubber boot which shall be securely clamped into a core-drilled pipe port. Pipe ports shall be core-drilled at the point of manhole manufacture and shall be accurately located within 1/2-inch of proposed sewer centerline; or, 2) a self-adjusting mechanical pipe to manhole seal which provides a resilient, flexible, and infiltration-proof joint; or, 3) a flexible rubber wedge firmly rammed into a rubber gasket which is cast into the manhole as approved in writing by the Engineer.

Neoprene rubber for manhole boots shall meet the requirements of ASTM C 443 and shall have a minimum thickness of 3/8-inch. Pipe clamp bands shall be of corrosion-resistant steel.

**b. Construction.**

**Material Handling:**

Pipe, fittings and accessories shall be loaded and unloaded by lifting with hoists or skidding so as to avoid shock or damage. Under no circumstances shall such material be dropped. Pipe handled on skidways shall not be skidded or rolled against pipe already on the ground.

In distributing the material at the site of the work, each piece shall be stored off of the ground surface by means of skids or bunks, and stacked neatly. Pipe may be "strung-out"

DETAILED SPECIFICATION  
FOR  
**SANITARY SEWER**

AA:MGN  
WT:VCM:CGT:AJK

8 of 25

04/08/14  
11/21/22

for only the length which, in the opinion of the Engineer, will be installed within 24 hours, if maintained such that the pipe interior will remain free of dirt, mud, and debris.

Excavation:

The Contractor shall dig-up and expose all utility crossings prior to laying any sanitary sewer pipe or lead. This will allow the Engineer to adjust the grade of the sanitary sewer or lead, if possible, to avoid the existing utilities. The costs of the dig-ups, and related costs, shall be included in the unit price of the sanitary sewer or lead. The Engineer may require that some dig-ups be performed out-of the staging area where the sewer work is taking place in order to aid in alignment decisions. Any required traffic control measures shall be included in the costs of "Minor Traffic Devices" and "Traffic Regulator Control."

Excavation shall include the removal and disposal of all materials of every kind, including rock, boulders, or buried obstructions necessary to be removed in the construction work.

The Contractor shall proceed with caution in the excavation and preparation of the trench so that the exact location of underground structures, both known and unknown, may be determined, and the Contractor shall be held responsible for the repair of such structures when broken or otherwise damaged.

Excavation normally shall be by open cut from the surface, except as otherwise specified, or in special cases where crossing under trees, pavements, or structures. The Contractor may use tunnel methods if permitted in writing by the Engineer, provided his method of backfill is such, in the judgment of the Engineer, as to avoid any present or future injury to the tree, pavement, or structure. All excavation shall be performed in such a manner as to provide adequate room for the construction and installation of the work to the lines, grades and dimensions shown on the Plans.

The trench shall be excavated to a minimum of four inches below the final location of the pipe. This cut shall be filled to the level of the bottom quadrant of the pipe with Coarse Aggregate, 6A as specified herein, shaped and compacted to the pipe barrel.

Bell holes shall be provided in the trench bottom at each joint to permit the joints to be made properly.

Whenever, in the opinion of the Engineer, it is necessary to explore and excavate to determine the location of existing underground structures, the Contractor shall make explorations and excavations for such purposes. These excavations will not be paid for separately, but shall be included in the cost of the item of work being performed. Any backfilling that may be required to be performed as a result of an exploratory excavation



DETAILED SPECIFICATION  
FOR  
**SANITARY SEWER**

AA:MGN  
WT:VCM:CGT:AJK

9 of 25

04/08/14  
11/21/22

that is not part of the backfill associated with the work being undertaken, shall be included in the item of work being performed, with the exception of final trench restoration, which shall be paid for separately using appropriate items of work contained within the contract documents.

All excavated material approved by the Engineer as backfill material and imported backfill material shall be piled in a manner that will not endanger the work and that will avoid obstructing sidewalks and driveways or clear vision areas along roadways, driveways, or parking areas. All excavated material which is unsuitable for backfill shall be immediately removed from the site by the Contractor. Hydrants under pressure, manholes of any kind, valve boxes, curb stop boxes, fire and police call boxes, and other utility controls shall be left unobstructed and accessible until the work is completed. Gutters shall be kept clear, or other satisfactory provisions made, for proper drainage. Natural and man-made water courses shall not be obstructed. Disposal of excavated material, if required, shall be the Contractor's responsibility.

Hand methods for excavation shall be employed in locations shown on the Plans. In other locations the Contractor may use trench-digging machinery or employ hand methods.

**Pipe Undercut:**

In locations where in the opinion of the Engineer, the soil at the bottom of the trench is unstable, the Contractor shall excavate below the trench bottom to such depth as directed by the Engineer and refill with compacted Aggregate, 6A (limestone), or compacted Granular Material, Class II, as directed by the Engineer, to the level of the bottom quadrant of the pipe. If refill with compacted Aggregate, 6A (limestone) is required during sewer construction, it shall be placed for the entire sewer run, from manhole to manhole.

**Trench Opening:**

The width of the trench shall be ample to permit the pipe to be laid and jointed properly, and the backfill to be placed and compacted as specified. Trenches shall be of such extra width, when required, to permit the convenient placing of timber supports, sheeting and bracing, and handling of special fittings. For each size of pipe, the minimum trench width shall provide clearance of four inches on each side of the bell of the pipe or fitting or six inches on each side of the pipe barrel, whichever is greater. The maximum trench width shall be in keeping with good construction practice, such that existing structures are not undermined.

In excavating for pipe lines, the excavation shall at all times be finished to the required grade in advance of the pipe line, but unless otherwise permitted in writing by the

DETAILED SPECIFICATION  
FOR  
**SANITARY SEWER**

AA:MGN  
WT:VCM:CGT:AJK

10 of 25

04/08/14  
11/21/22

Engineer, not more than 50 feet of trench shall be open at one time in advance of the pipe. At no time shall more than 200 feet of trench be opened and incompletely backfilled. At the end of each day, no more than 25 feet of trench may be left open, and access to all drives shall be restored. This opening shall be surrounded by fencing and lighted barricades, or plated. The remainder of the trenching operation shall be available for safe vehicular and pedestrian traffic at all times.

The trench shall be so braced and drained that the workers may work therein safely and efficiently. It is essential that the discharge of the trench dewatering pumps be conducted to natural drainage channels, drains, or storm sewers. If trench water is pumped to natural drainage channels or drains, approved soil erosion and sedimentation controls shall be installed and maintained at the point of discharge. If trench water is pumped into storm sewers, filters shall be provided to prevent the flow of rocks, mud and other debris into the storm sewer line.

The length of street which may be occupied by the construction work at any one time shall be subject to the approval of the Engineer and will be based on the requirements of use of the street by the public.

The Contractor shall fully comply with all laws and regulations governing construction methods and the furnishing and use of all safeguards, safety devices, protective equipment, and pollution controls. Particular care shall be taken to conform to all applicable rules of the Michigan Department of Labor, Construction Safety Standards Commission, "Safety Standards". Part 9 of the above document should be particularly noted.

Where required to support the surfaces of adjacent thoroughfares, structures, or excavations, or to protect the construction work, adjacent work, or workmen; sheeting, bracing, and shoring shall be provided. The placing of such supports shall not release the Contractor of the responsibility for the sufficiency and integrity of the trench opening. In the removing of sheeting and bracing after the construction has been completed, special care shall be taken to prevent any caving of the sides of the excavation and injury to the completed work or to adjacent property.

Sheeting, bracing, and shoring shall not be left in place after completion of the work except as required by the Engineer. Where the Engineer requires the sheeting, bracing, or shoring to be left in place it shall be cut off below the established surface grade as required by the Engineer.

Disposal of Water and Sewage:

The Contractor shall remove by well points, pumping, bailing, or other acceptable method

DETAILED SPECIFICATION  
FOR  
**SANITARY SEWER**

AA:MGN  
WT:VCM:CGT:AJK

11 of 25

04/08/14  
11/21/22

any water which may accumulate or be found in the trenches or other excavations to be made. The Contractor shall take all necessary precautions to keep the trenches and other excavations entirely clear of water and sewage during construction of pipe lines and structures. Newly placed concrete shall be adequately protected from injury resulting from ground water or sewage. No drainage ditches shall be placed within the area to be occupied by any structure except as permitted in writing by the Engineer.

The Contractor shall at all times have upon the work sufficient pumping equipment ready for immediate use to carry out the intent of this section.

Where existing sewers, drains, or ditches are encountered in this work, adequate provisions shall be made for diverting their flow, so that the excavation will be kept dry. Upon completion of the construction work, the existing sewers, drains, or ditches shall be restored as directed by the Engineer.

**Crossing Existing Structures & Facilities:**

During the construction it may be necessary to cross under or over certain sewers, service leads, drains, culverts, water lines, gas lines, electric lines, and other underground structures or facilities, known or unknown. The Contractor shall make every effort to prevent damage to such underground structures and facilities. The Contractor shall not intentionally "dig through" existing facilities with the intention of replacing or repairing them after the proposed work is completed. Wherever such structures or facilities are disturbed or broken, they shall be restored to a condition equal to, or better than, the condition that existed prior the work being performed. All repairs shall acceptable to the owner and the City and shall be at the Contractor's sole expense. These crossings shall be made with a minimum of twelve inches of vertical clearance between facilities.

**Laying Pipe:**

Each pipe shall be inspected for defects prior to being lowered into the trench. The inside of each pipe and outside of each spigot shall be cleaned of any earth or foreign matter.

Proper implements, tools, and facilities satisfactory to the Engineer shall be provided and used by the Contractor for the safe and convenient prosecution of the work. All pipe and fittings shall be carefully lowered into the trench piece by piece by means of a derrick, ropes, or other suitable tools or equipment as recommended by the manufacturer, in such a manner as to prevent damage to them and their protective coatings and linings. Under no circumstances shall materials be dropped or dumped into the trench.

New sewer construction shall be plugged at the outlet, so as to not be connected into the existing system until it has been tested and accepted. Construction of sewers shall begin

DETAILED SPECIFICATION  
FOR  
**SANITARY SEWER**

AA:MGN  
WT:VCM:CGT:AJK

12 of 25

04/08/14  
11/21/22

at the outlet end and proceed upgrade, unless otherwise directed by the plans or the Engineer. Pipe shall be laid on the prepared subgrade with the bell ends facing the direction of laying, unless otherwise directed by the Engineer.

The Contractor shall take every precaution to prevent foreign material from entering the pipe while it is being placed in the line. During laying operations, no debris, tools, clothing or other materials shall be placed in the pipe. At times when pipe laying is not in progress, the open ends of pipe shall be closed by a watertight plug. This provision shall apply during the break period as well as overnight. If water is in the trench, the seal shall remain in place until the trench is pumped completely dry.

Pipe shall be jointed as specified elsewhere herein. The pipe shall be secured in place with approved backfill material tamped under it except at the bells. Pipe and fittings which do not allow a sufficient and uniform space for joints shall be removed and replaced with pipe and fittings of proper dimensions to insure such uniform space. Precautions shall be taken to prevent dirt from entering the joint space.

All pipe shall be laid at the correct line and grade as indicated by the grade stakes and offset line. The correct line and grade shall be maintained by the use of a laser alignment system. The staking shall be provided by the Engineer. No pipe shall be laid until a cut sheet for that pipe has been approved by the Engineer. Each pipe, as laid, shall be checked by the Contractor to insure that this result is obtained. The grade as shown on the Plans is that of the pipe invert for sewers; the work must conform to this profile. A variation of 1/4 inch from this profile grade will be deemed sufficient reason to cause the work to be rejected and re-laid. Sewer pipe alignment shall be maintained so as to not vary more than one-half inch from the correct line on pipes up to 36 inches in diameter nor more than one inch on pipes 42 inches in diameter and larger. Any pipe found out of line shall be re-laid properly by the Contractor.

Due to conditions in the field, changes to the proposed vertical and horizontal alignment of the proposed sanitary sewer may become necessary. The Contractor shall, where directed by the Engineer, excavate up to 60 feet in advance of the pipe laying operation to expose existing underground facilities thereby enabling the Engineer to make alignment decisions. The Contractor is required to realign (re-lay) the sanitary sewer up to 2 feet vertically and/or horizontally as directed by the Engineer at no extra cost to the project. The excavation in advance of the pipe laying is intended to help eliminate the need for re-laying pipe.

Making Joints

General:

DETAILED SPECIFICATION  
FOR  
**SANITARY SEWER**

AA:MGN  
WT:VCM:CGT:AJK

13 of 25

04/08/14  
11/21/22

Mechanical means shall be used for pulling home all rubber-gasket pipe regardless of trench condition where manual means will not result in pushing and holding the pipe home. When a trench box or liner is used, a cable shall be used to pull the joints home and hold them in position.

Where work is performed in wet trenches or trenches with running sand, the Contractor shall provide and use mechanical means for pulling the pipe home in making up the joint and for holding the pipe joints tight until completion of the line. Mechanical means shall consist of a cable placed inside or outside of the pipe with a suitable winch, jack, or come-along for pulling the pipe home and holding the pipe in position.

Where not required by these Specifications, manual means will be acceptable only if the joints can be pushed home and held.

Sewer pipe may not be cut when the cut end will be used in making a pipe joint. Cut ends may only occur in situations such as a manhole or headwall. Cut ends shall be carefully and neatly made with a saw, pipe cutter, or other approved means.

**Vitrified Clay Pipe:**

Compression-type joints shall be made in accordance with manufacturer's standards and ASTM C 425. The jointing surfaces of the pipe shall be wiped clean, and lubricated using lubricants supplied by the pipe manufacturer. The socket and spigot shall be lined up and joined together with a steady, uniformly applied force.

**Polyvinyl Chloride (PVC) Pipe:**

Elastomeric gasket, push-on joints, shall be made in accordance with manufacturer's standards, and ASTM D2321 and D3212. The jointing surfaces of the pipe shall be wiped clean, and lubricated using lubricant supplied by the pipe manufacturer. The spigot end is to be inserted into the bell so that it is in contact with the gasket. The bell is to be braced while the spigot end is pushed in under the gasket, so that previously completed joints will not be altered. The spigot shall be pushed into the bell until the reference mark on the pipe barrel is flush with the end of the bell.

**Backfilling**

**Vitrified Clay Pipe:**

All pipe shall be bed on a four inch or thicker layer of compacted Granular Material, Class II or compacted Aggregate, 6A (limestone) as specified herein.

DETAILED SPECIFICATION  
FOR  
**SANITARY SEWER**

AA:MGN  
WT:VCM:CGT:AJK

14 of 25

04/08/14  
11/21/22

From the bedding to the pipe centerline backfill shall be carefully placed Granular Material, Class II, placed in maximum lift thicknesses of six inches, loose measure. Each lift shall be thoroughly compacted by hand tamps, pneumatic "pogo-sticks", or other approved methods, to at least 95% of the material's maximum dry density at optimum moisture content as determined by ASTM D 1557, Method C, or AASHTO T-180. Each lift shall extend the full width of the space between the pipe and trench, and the fill shall be brought up evenly on both sides of the pipe. The backfill under the haunches of the pipe shall be consolidated by the use of a tee-bar.

When the pipe is greater than 48 inch diameter, or when permitted in writing by the Engineer, the Granular Material, Class II from the bedding to the centerline may be replaced by Aggregate, 6A (limestone) as specified. A suitable granular filter, designed by the Contractor and approved by the Engineer, shall be provided above the coarse aggregate to prevent intrusion of succeeding backfill materials.

From the pipe centerline to the top of the pipe, backfill shall be Granular Material, Class II placed in maximum lift thicknesses of six inches, loose measure. Each lift shall be thoroughly compacted by hand tamps, pneumatic "pogo-sticks", or other approved methods, to at least 95% of the material's maximum dry density at optimum moisture content as determined by ASTM D 1557 Method C, or AASHTO T-180.

From the top of the pipe to two feet above the top of the pipe backfill shall be Granular Material, Class II uniformly spread and machine tamped. Machine tamping shall include manually operated vibrating plate compactors. The backfill material shall be compacted in lifts of twelve inches, loose measure.

From two feet above the top of the pipe to the grade shown on the Plans and Details, or to the subgrade of roadway materials, or to the subgrade of surface structures, backfill shall be Granular Material, Class II uniformly spread and machine tamped. If machine tamping includes manually operated vibrating plate compactors or self propelled vibrating rollers the backfill material shall be compacted in lifts not exceeding twelve inches, loose measure. If a backhoe mounted compactor is employed, the backfill material shall be compacted in lifts of thirty-six inches, loose measure. Approval to use a particular machine tamping method will be withdrawn by the Engineer if the method causes injury to the pipe or adjacent structures or movement of the pipe. Each lift shall be thoroughly compacted to at least 95% of the material's maximum dry density at optimum moisture content as determined by ASTM D 1557, Method C, or AASHTO T-180. The Engineer may give consideration to giving written permission to increase the thickness of the lifts specified in this paragraph if satisfactory compaction is achieved and no undesirable side effects occur.

PVC Pipe:

DETAILED SPECIFICATION  
FOR  
**SANITARY SEWER**

AA:MGN  
WT:VCM:CGT:AJK

15 of 25

04/08/14  
11/21/22

All pipe shall be bed on a four inch or thicker layer of compacted Coarse Aggregate, 6A (limestone) as specified herein.

From the bedding to the pipe centerline backfill shall be carefully placed Coarse Aggregate, 6A (limestone), placed in maximum lift thicknesses of six inches, loose measure. Each lift shall be thoroughly compacted by hand tamps, pneumatic "pogo-sticks", or other approved methods. Each lift shall extend the full width of the space between the pipe and trench, and the fill shall be brought up evenly on both sides of the pipe. The backfill under the haunches of the pipe shall be consolidated by the use of a tee-bar.

From the pipe centerline to the top of the pipe, backfill shall be Aggregate, 6A (limestone) placed in maximum lift thicknesses of six inches, loose measure. Each lift shall be thoroughly compacted by hand tamps, pneumatic "pogo-sticks", or other approved methods. A layer of geotextile separator, meeting the requirements of Section 910, extending the full width of the trench, shall be provided above the coarse aggregate to prevent intrusion of succeeding backfill materials.

From the top of the pipe to two feet above the top of the pipe, unless otherwise specified, backfill shall be Granular Material, Class II placed in a maximum lift thickness of twelve inches, loose measure. These lifts shall be thoroughly compacted by manually operated vibrating plate compactors, to at least 95% of the material's maximum dry density at optimum moisture content, as determined by ASTM D 1557, Method C, or AASHTO T-180.

From two feet above the top of PVC pipe to the grade shown on the Plans and Details, or to the subgrade of roadway materials, or to the subgrade of surface structures, backfill shall be Class II granular material uniformly spread and machine tamped. If machine tamping includes manually operated vibrating plate compactors or self propelled vibrating rollers the backfill material shall be compacted in lifts not exceeding twelve inches, loose measure. If a backhoe mounted compactor is employed, the backfill material shall be compacted in lifts of thirty-six inches, loose measure. Approval to use a particular machine tamping method will be withdrawn by the Engineer if the method causes injury to the pipe or adjacent structures or movement of the pipe. Each lift shall be thoroughly compacted to at least 95% of the material's maximum dry density at optimum moisture content as determined by ASTM D 1557, Method C, or AASHTO T-180. The Engineer may give consideration to giving written permission to increase the thickness of the lifts specified in this paragraph if satisfactory compaction is achieved and no undesirable side effects occur.

General

DETAILED SPECIFICATION  
FOR  
**SANITARY SEWER**

AA:MGN  
WT:VCM:CGT:AJK

16 of 25

04/08/14  
11/21/22

Backfilling shall not be performed in freezing weather except by written permission of the Engineer, and it shall not be composed of frozen material. No fill shall be placed where the material already in the trench is frozen.

**Concrete Cradle and Encasement for Sewers:**

Where shown on the Plans, pipe shall be installed with a concrete cradle or encasement of Concrete, Grade X as shown on the Standard Details or plan sheets. Cradle or encasement shall be for the full run of the sewer, from manhole to manhole. Each pipe shall rest on a bed of Concrete, Grade X, shaped to fit the bottom of the pipe. After setting the pipe, the space between the outside of the pipe and the undisturbed trench bank shall be completely filled with Concrete, Grade X. Concrete, Grade X used for this purpose shall have a slump not exceeding two inches.

**Riser Pipe for Service Leads:**

Where shown on the Plans or directed by the Engineer, the Contractor shall furnish and place risers extending from the branch opening of the sewer up to within eight to ten feet of the proposed finished grade. These pipes shall be laid with joints as specified above. These risers shall be laid up and held in place as required by the Standard Details. The connection fitting when a riser is to be used shall be a tee fitting. Openings in the top of the riser pipe shall be closed, marked, and staked as specified above.

**Service Lead Connections and Fittings:**

Service lead connections shall be provided at such points as shown on the Plans or as directed by the Engineer. These shall be of the size and character indicated on the Plans. House service leads shall be a minimum of four inches in diameter. Service lead connections shall be formed by the use of standard wye or tee fittings of the same material called for use on the main sewer being constructed. Wye fittings are not to be used for connections with riser pipes. All wye and tee fittings shall be encased in Concrete, Grade X. All leads which will not have pipe connected to them immediately shall be closed by the use of a watertight plug manufactured specifically for that purpose and approved by the Engineer.

Branch connections to existing sewers shall be made by the City of Ann Arbor – Field Operations Personnel. Scheduling of these taps shall be made with Field Operations by the Contractor. All applicable tap fees must be paid in full prior to this scheduling.

Connections for sewer service leads connecting to existing sewer mains or sewer mains of a different pipe material shall be at a core-drilled tap into the sewer pipe. The joint at this tapped connection shall be made using either a gasketed sewer saddle, a flexible



DETAILED SPECIFICATION  
FOR  
**SANITARY SEWER**

AA:MGN  
WT:VCM:CGT:AJK

17 of 25

04/08/14  
11/21/22

neoprene rubber boot securely clamped into the core-drilled tap, or approved equal. The end of the sewer service lead pipe shall be flush with the inside wall of the sewer main. Gasketed sewer saddles shall meet the following requirements:

- g) The castings shall be ductile iron per ASTM 536, Grade 65-45-12, protected with a yellow shopcoat.
- h) The adjustable strap shall be 3.5" wide, stainless steel per ASTM A 240, type 304.
- i) The bolts shall be 0.5" UNC rolled thread, lubricant coated, stainless steel per ASTM A 1943, type 304.
- j) The nuts shall be per ASTM A 194, type 304.
- k) The washers shall be stainless steel per ASTM A 240, type 304 and plastic lubricating washers.
- l) The gaskets shall be SBR per ASTM D 2000 MBA 710, compounded for water and sewer service.

In order to properly mark the location of every branch connection, the Contractor shall take accurate measurement of all branches before the sewer trench is backfilled. The measurements shall indicate the distance from each branch to the center of the nearest downstream and upstream manhole. When leads are run to the property line, they shall be perpendicular to the main sewer. The Contractor shall also report the location of the point where the lead ends, relative to the nearest property corners. The Contractor shall furnish the Engineer with a copy of these measurements immediately upon the completion of each section of sewer.

In addition to measurements, the Contractor shall furnish and place a minimum two inch by two inch cedar or treated lumber marking stick at the end of each lateral extension or service lead connection of such length that it will reach from the end of the pipe vertically up to a minimum of two inches above the proposed finished grade. Each marker shall be set in a vertical position. Markers will not be required on the main run of sewer at fittings. The visible end of each marker stake must be plainly painted red if sanitary or white if storm.

The service lead pipes shall also be marked for identification in order to prevent cross connection of the leads: sanitary leads - red, storm leads - white. The last two lengths of pipe shall be marked by wrapping the appropriate colored tape twice around the barrel. This wrapping shall take place at any point in the lead whenever the lead is terminated. This taping (wrapping) must be performed under the inspection of the Inspector.

Manholes:

Excavation shall be carried to the depth and width required to permit the construction of the required base. The excavation width shall be greater than the base. The bottom of

DETAILED SPECIFICATION  
FOR  
**SANITARY SEWER**

AA:MGN  
WT:VCM:CGT:AJK

18 of 25

04/08/14  
11/21/22

the excavation shall be trimmed to a uniform horizontal bed and be completely dewatered before any concrete is placed therein. Concrete shall be Grade S2. Precast manhole bases and precast bottom sections are allowed.

Precast concrete manholes shall be constructed of Concrete, Grade S2.

Circular precast manhole sections shall be constructed in accordance with the Standard Detail Drawings. Manhole stack units shall be constructed on level poured-in-place bases, precast concrete bases, or precast concrete bottom sections.

Precast cone sections shall be constructed in accordance with the Standard Details. These units shall be eccentric for all manholes. All structures shall be topped with a minimum of one and a maximum of three brick or precast adjustment ring courses.

Manholes shall be constructed within 2-1/2 inches of plumb.

Frames and cover castings shall be set in full mortar beds and pointed on the structure interior to a smooth, brushed finish. The covers shall be set flush with sidewalk, roadway pavement, or ground surfaces. City of Ann Arbor Project Management Personnel shall be notified prior to the final paving of all private roads and parking lots so as to allow inspection of the final casting adjustments for all City utility structures. In gravel streets, covers shall be set six to eight inches below finished gravel surface.

Sewer pipes shall extend into structures a minimum of 1/2 inch and a maximum of 3 inches.

Flow channels for sewer structures shall be finished in accordance with the Standard Details. All flow channels shall be screeded and floated to a smooth, uniform surface and troweled to a hard surface finish. In vitrified clay sewers, the manhole may be constructed around the pipe, then the top half of the pipe broken out with concrete fillets provided to fill in between the pipe and manhole.

Stubs for future sewer connections shall be furnished and placed by the Contractor as shown on the Plans and as directed by the Engineer. Connections shall be properly supported and braced when not resting on original ground so that any settlement will not disturb the connection. Stubs shall consist of one length of sewer pipe, of the size indicated on the Plans, with a watertight plug.

See Sewer Testing section for the requirement of the installation of a pipe nipple through the sewer manhole wall.

Drop Connections:

DETAILED SPECIFICATION  
FOR  
**SANITARY SEWER**

AA:MGN  
WT:VCM:CGT:AJK

19 of 25

04/08/14  
11/21/22

Where shown on the Plans or directed by the Engineer where a branch sanitary sewer is brought into a manhole more than 24 inches above the invert elevation in the manhole, a drop connection shall be provided in accordance with the Standard Detail Drawings.

**Backfilling Around Manholes:**

As soon as practicable after a precast structure has been set, forms and debris have been removed from the structure, and the structure has been inspected and approved, the excavated area around the structure shall be backfilled up to the specified grade with Granular Material, Class II. No boulders, rocks, stones, masonry, lumber, or debris shall be allowed within the backfill.

**Sewer Testing:**

All sanitary sewers, including leads, 36 inches and smaller shall be air tested by the Contractor. All sanitary sewers greater than 36 inches shall be infiltration or exfiltration tested by the Contractor. The Engineer will decide whether infiltration or exfiltration testing is performed based upon ground water conditions. All sewers, except 4-inch and 6-inch leads, shall be television inspected by the Contractor. All PVC sanitary sewer mains shall be mandrel tested. All sewer must meet each test, in order (mandrel testing, air or infiltration/exfiltration, television inspection), before the next test is performed. The Contractor shall furnish all labor, equipment and materials necessary for testing. Only after all tests have been successfully completed, and acknowledged by the Engineer in writing, may the sewer be placed in service.

**Mandrel Testing:**

All PVC sanitary sewer mains shall be mandrel tested for deflection by the Contractor. The mandrel shall be a commercially produced, nine-fin mandrel, with the pipe diameter, percent deflection and applicable ASTM or AASHTO standard stamped on the fins. The testing is to take place after the sewers have been in place for a minimum of 30 days. The mandrel shall be pulled from structure to structure. Any portion of the pipe through which the mandrel passes freely shall be deemed to have passed the mandrel test. Sections of pipe through which the mandrel does not pass freely shall be exposed and examined. Based on this examination either the pipe zone bedding and backfill shall be improved or the pipe replaced. The pipe shall then be re-tested before approval is granted.

The Contractor shall not be granted an extension of contract time for the period in which a portion(s) of PVC sanitary sewer is awaiting mandrel and other acceptance tests. This waiting period is understood to be an integral element of the construction of the utility and cannot be eliminated. Further, if a sewer is installed and requires remedial action in order

DETAILED SPECIFICATION  
FOR  
**SANITARY SEWER**

AA:MGN  
WT:VCM:CGT:AJK

20 of 25

04/08/14  
11/21/22

to comply with the requirements of the project specifications, the waiting period associated with the remedial repairs shall also not be considered as a basis for an extension of contract time. The Contractor shall take these requirements into account when preparing their Critical Path Schedule, and any required updates, and shall account for them during the performance of the project.

The mandrel is to be constructed in accordance with the following table:

SDR 35 PVC, Pipe I.D.	Mandrel O.D.
8"	7.28"
10"	9.08"
12"	10.79"
15"	13.20"
18"	N/A
24"	N/A

**Air Test:**

The air test can be dangerous. Lack of understanding, carelessness, or an improperly prepared line must be avoided. It is extremely important that the plugs be installed in such a way as to prevent blowouts. Sudden expulsion of a poorly installed or partially deflated plug can cause serious injury or damage. As a safety precaution, pressurizing equipment must include a relief valve set at not more than 10 psig. No one will be allowed in the manholes during testing.

In areas where ground water is known to exist and the sewer is to be air tested, the Contractor shall install a 1/2-inch diameter by approximately 10 inch long pipe nipple, through the manhole wall above one of the sewer lines entering the manhole. The pipe nipple shall be capped on the inside of the manhole at the time the sewer line is installed. Immediately prior to the performance of the air test, the ground water level shall be determined by removing the pipe cap, blowing air through the pipe nipple into the ground so as to clear it, and then connecting a clear plastic tube to the pipe nipple. The tube shall be held vertically and a measurement of the height in feet of water above pipe centerline shall be taken after the water stops rising in this plastic tube. The height in feet shall be divided by 2.31 to establish the pressure (in psig) that will be considered to be the average ground water back pressure.

The normal sequence and time requirements for air testing are:

1. After a manhole-to-manhole section of line has been backfilled and cleaned, it shall be plugged at each manhole with pneumatic plugs. The design of the pneumatic

DETAILED SPECIFICATION  
FOR  
**SANITARY SEWER**

AA:MGN  
WT:VCM:CGT:AJK

21 of 25

04/08/14  
11/21/22

plugs shall be such that they will hold against the line test pressure without requiring external blocking or bracing. There shall be three hose connections to the pneumatic plug. One hose shall be used only for inflation of the pneumatic plug. The second hose shall be used for continuously reading the air pressure rise in the sealed line. The third hose shall be used only for introducing low pressure air into the sealed line.

2. Low pressure air shall be introduced into the sealed line until the internal air pressure reaches 4.0 psig greater than the average back pressure of any ground water pressure that may be over the pipe. At least two minutes shall be allowed for the air pressure to stabilize. After the stabilization period, the pressurization hose shall be disconnected to prevent air from entering or escaping from the line.

There shall be a pressure gauge for reading the internal pressure of the line being tested. The gauge shall be capable of showing pressure as low as 0 psig up to no greater than 20 psig. In the 0-10 psig range the gauge shall be both calibrated and accurate to one-tenth of one pound and the gauge dial shall cover at least one-half of the complete dial range. This gauge shall have a tee fitting to allow simultaneous pressure reading by a City gauge.

3. The time requirement for the pressure to decrease from 3.5 to 2.5 psig (greater than the average back pressure of any ground water that may be over the pipe) shall not be less than the time given in the following table:

<u>Pipe Size</u>	VCP SEWERS	PVC SEWERS	
	<u>Minimum Holding Time Seconds/100 ft. Pipe</u>	<u>Holding Time (Seconds)</u>	<u>Minimum Holding Time (Min:Sec)</u>
4-inch	18	0.380 x Length	3:46
6-inch	42	0.854 x L	5:40
8-inch	72	1.520 x L	7:34
10-inch	90	2.374 x L	9:26
12-inch	108	3.418 x L	11:20
15-inch	126	5.342 x L	14:10
18-inch	144	7.692 x L	17:00
21-inch	180	10.470 x L	19:50
24-inch	216	13.674 x L	22:40
30-inch	288	21.366 x L	28:20
36-inch	360	30.768 x L	34:00

Infiltration Test:

DETAILED SPECIFICATION  
FOR  
**SANITARY SEWER**

AA:MGN  
WT:VCM:CGT:AJK

22 of 25

04/08/14  
11/21/22

The Contractor shall place temporary weirs for testing purposes in such manholes as necessary to measure the amount of infiltration. Test sections shall be no longer than 1,200 feet.

The allowable amount of infiltration shall not be more than 200 gallons per inch of pipe diameter per mile of sewer per 24 hours, including manholes. The Contractor shall repair all visible leaks regardless of the results of the infiltration test.

If the allowable limit of infiltration is exceeded on any test section, the Contractor shall reconstruct or repair the defective portion of the sewer, and re-test.

**Exfiltration Test:**

The standpipe method will be used from manhole to manhole for the length of pipe to be tested. A hydrostatic head of 10 ft. to the sewer's average centerline elevation will be required, with adjustments for external submergence due to water in the trench. The Engineer will establish time durations and procedures for each test. The maximum allowable exfiltration rate will be 200 gallons per inch of pipe diameter per mile of sewer per 24 hours including manholes. Upon completion of this test on a sanitary sewer, the Contractor shall pump all water out of the downstream manhole to a storm sewer.

**Television Inspection:**

A video inspection must be approved prior to the acceptance of the sewers, and prior to any building connections being made. The Engineer shall be given 24 hours notice so that an Inspector may witness the video inspection. All sewer lines are to be thoroughly cleaned prior to video inspection, by jetting of the lines or other approved methods. Video inspection shall consist of wetting the invert of the section by pouring clean water in the upstream manhole until it appears in the downstream manhole, and then, after the water has stopped flowing, passing a video camera through the section. The camera shall be connected to a monitor and the results recorded in DVD format. The inspection record (DVD) shall indicate the date, the section tested, and the actual distance from the beginning manhole to each tee or wye, and each visible defect. The DVD shall be furnished to the Engineer for further review and final approval.

The video inspection will be deemed satisfactory if there are no visible defects, including, but not limited to: dips or low spots, high spots, deviations in horizontal or vertical alignment, joint offsets, leaks or cracks and there is no debris or other foreign material in the sewer system.

**Sewer Repairs:**

DETAILED SPECIFICATION  
FOR  
**SANITARY SEWER**

AA:MGN  
WT:VCM:CGT:AJK

23 of 25

04/08/14  
11/21/22

If a sewer repair is required as a result of damage during construction operations, air test failure, or video inspection failure, the Contractor shall expose the sewer pipe and perform the required correction(s), as specified herein and as directed by the Engineer. The Contractor shall be fully responsible to provide a written plan of all proposed activities associated with any repair(s) for the review and approval of the Engineer. All repairs proposed shall be effective. The Engineer's acceptance of a proposed repair plan shall not be construed as acceptance of any associated result. The Contractor is, and shall remain responsible, for all work until such time as it is formally accepted in writing by the Engineer.

If the repair is required due to the pipe being out of alignment or off grade, the pipe shall be adjusted so as to be placed in proper alignment and grade. Aggregate, 6A (limestone) shall be carefully placed under the haunches of the realigned pipe and compacted by the use of a tee-bar. From the haunches of the pipe, backfilling shall be performed as specified elsewhere herein.

If the pipe cannot be satisfactorily realigned or an open joint reset; or if the pipe is cracked, broken, or permanently deflected, the affected pipe shall be removed and replaced with the same pipe material. The pipe to be removed is to be sawed on each side of the damaged section in a neat and workmanlike manner without damage to the adjacent pipe. The replacement pipe section shall fit flush to the remaining pipe at each end. These sawed joints shall be coupled using a flexible pipe coupling and stainless steel shear ring. These joints shall be encased to the pipe centerline with Concrete, Grade X one foot on either side of the flexible coupling. The remaining pipe backfill shall be performed as specified elsewhere herein.

**c. Measurement and Payment.** The completed work as described will be measured and paid for at the contract unit price using the following contract items (pay items):

<u>Contract Item (Pay Item)</u>	<u>Pay Unit</u>
Sewer, SDR 35 PVC Pipe, ____ inch, Tr Det ____ .....	Foot
Type I Manhole (4 ft dia) (0-10 ft. Deep) .....	Each
SDR 35, PVC Tee.....	Each
SDR 35, PVC Riser .....	Vft
SDR 35, PVC Service Lead.....	Foot

DETAILED SPECIFICATION  
FOR  
**SANITARY SEWER**

AA:MGN  
WT:VCM:CGT:AJK

24 of 25

04/08/14  
11/21/22

#### Sewer Pipe

Sewer pipe as specified shall be measured in place by length in lineal feet (LF) from center of manhole to center of manhole.

Payment will include, but not be limited to; excavation; removal and proper disposal off-site of all excess or unsuitable excavated material; any needed sheeting, shoring and bracing; the installation of water-tight plugs; protection of all existing utilities and service connections; connections into existing structures; bulkheading existing connections that are no longer needed in existing manholes; pipe bedding; by-pass pumping; furnishing an approved geotextile separator; backfilling per the trench details and the requirements specified herein; cleaning; video inspection; and testing.

#### Service Tees

Service tees shall be paid for based on each tee installed. The payment for the service tee will include the material, equipment and labor costs for the connection of the riser or lead to the tee. Also, the payment for the service tee will include the material, equipment and labor costs for the excavation; removal and proper disposal off-site of all excess or unsuitable excavated material; any needed sheeting, shoring and bracing; the installation of water-tight plugs; protection of all existing utilities and service connections; pipe bedding; by-pass pumping; furnishing an approved geotextile separator; backfilling per the trench details and the requirements specified herein; cleaning; testing; placing the plug or cap placed on the tee, riser or lead; and, the required wooden stake to locate the riser or lead in the future.

#### Risers & Leads

Service risers shall be paid for based on vertical feet (VF) measured as installed, from invert of the sewer main to invert of the bend at the top of the riser.

Service leads shall be paid for based on lineal feet (LF) measured as installed, from the center of the main to the capped end of the lead. If a service riser is installed, this measurement shall be from the center of the bend at the top of the riser to the capped end of the lead. The payment for service leads will include, but not be limited to; excavation; removal and proper disposal off-site of all excess or unsuitable excavated material; any needed sheeting, shoring and bracing; the installation of water-tight plugs; protection of all existing utilities and service connections; connections into existing structures; pipe bedding; by-pass pumping; furnishing an approved geotextile separator; backfilling and compacting per the trench details and the requirements specified herein; cleaning; video inspection; testing; and, the necessary fittings, labor and equipment to connect the lead to a riser.



DETAILED SPECIFICATION  
FOR  
**SANITARY SEWER**

AA:MGN  
WT:VCM:CGT:AJK

25 of 25

04/08/14  
11/21/22

### Manholes

Manholes of the detail and depth specified will be paid for at the Contract unit price for each unit installed. Payment includes, but shall not be limited to; furnishing the labor, equipment and materials for all necessary excavation; any needed sheeting, shoring and bracing; properly disposing of surplus or unsuitable excavated material; backfilling and compaction; and, constructing the structure complete, including pipe connections and structure cleaning, up to 10 feet of drainage structure depth.

Payment for additional depth for drainage structures includes, but shall not be limited to; furnishing the labor, equipment, and materials for all necessary excavation; any needed sheeting, shoring and bracing; disposing of surplus excavated material; backfilling and compaction; and constructing the structure complete, including pipe connections and structure cleaning, for the portion of the structure which is deeper than 10 feet.

Payment for adjusting of manhole frames and covers shall be included in payment for the manhole. The manhole frames and covers will be paid for separately.

### Drop Connections

Payment for drop connections shall be based on vertical feet (VF) installed. Payment includes, but shall not be limited to; furnishing all labor, equipment and materials for all necessary excavation; any needed sheeting, shoring and bracing; proper removal and disposal off-site of surplus and unsuitable excavated material; pipe, fittings, and concrete; backfilling and compaction; and, connections to complete this item of work. Vertical footage will be measured from the bottom invert of the drop connection to the top invert of the drop connection.

### Pipe Undercut & Refill

The Contractor shall note that undercut quantities shown on the Bid Form are estimates only. The quantities of undercut may vary significantly more or less depending on field conditions at the time of construction. Any variation from the bid amount shall not be a basis of claim for additional compensation pursuant to Sections 103.02.B or 104.10 .

Measurement for refill width will be the outside diameter of the pipe barrel plus two feet. Measurement for depth will be from the bottom of the excavation to the bottom of the pipe barrel.

Payment will be based on cubic yards (CY) as measured compacted in place, as described above. Payment will include the additional excavation, placement of refill material compacted in place, and all related work.

DETAILED SPECIFICATION  
FOR  
**DRAINAGE STRUCTURES**

AA:MGN  
WT:VCM:CGT:AJK

1 of 6

11/17/15  
11/21/22

**a. Description.-** This work shall consist of constructing drainage structures in accordance with Section 403 of the Michigan Department of Transportation 2020 Standard Specifications for Construction, as shown on the plans, and as specified herein.

**b. Materials.-** The materials used for this work shall conform to Subsection 403.02 of the Michigan Department of Transportation 2020 Standard Specifications for Construction, except as specified herein.

Storm sewer drainage structures shall be constructed of precast or cast-in-place reinforced concrete sections, or concrete masonry units. All sanitary sewer manholes and gate wells (water main valve manholes) shall be constructed of precast reinforced concrete sections.

Precast reinforced concrete bases, bottom sections, manhole risers, grade adjustment rings, concentric cones, eccentric cones, and flat slab tops shall conform to the requirements of ASTM C-478. Joints on precast manholes used on all sanitary sewers shall meet ASTM C-443, rubber O-ring gasket.

Precast manhole tees and radius pipe sections shall conform to requirements for reinforced concrete pipe, ASTM C-76, Class IV. Joints shall conform to adjacent pipe. Tees and radius pipe shall conform to details indicated on drawings offered by the Concrete Pipe Association of Michigan, Inc., or Engineer approved equal.

If precast drainage structures are used, they shall be designed to accommodate HL-93 Modified Live Load requirements as determined by a Professional Engineer licensed by the State of Michigan, regardless of where they are to be installed. For the purposes of design, a HL-93 Modified Live Load shall consist of 1.2 times the design truck or 1.2 times a single 60 kip load, whichever produces the greater stresses.

If precast structures are used, the Contractor shall field verify inverts prior to fabricating precast units. No additional payment will be made to the Contractor for precast units that cannot be used due to existing inverts being different than shown on the plans, changes in vertical or horizontal alignment due to conditions found in the field, or similar unforeseen circumstances.

If the Contractor elects to use pre-cast drainage structures, or if portions of the drainage structures are constructed with pre-cast concrete elements, the Contractor shall submit to the Engineer for review and approval shop drawings in accordance with Section 104.02 of the Michigan Department of Transportation 2020 Standard Specifications for Construction.

DETAILED SPECIFICATION  
FOR  
**DRAINAGE STRUCTURES**

AA:MGN  
WT:VCM:CGT:AJK

2 of 6

11/17/15  
11/21/22

For each submittal or resubmittal, the Contractor shall allow at least 14 calendar days from the date of the submittal to receive the Engineer's acceptance or request for revisions. The Engineer's comments shall be incorporated into the submitted plans, calculations and descriptions. The Engineer's acceptance is required before beginning the work. Resubmittals shall be reviewed and returned to the General Contractor within 14 calendar days. Required revisions will not be a basis of payment for additional compensation, extra work, or an extension of contract time. The Contractor shall include time for this entire review process in his/her CPM network schedule.

Concrete masonry units shall conform to the requirements for concrete masonry units for catch basins and manholes, ASTM C-139.

Concrete brick shall conform to the requirements for concrete building brick, ASTM C-55, Grade N-1.

Slide gate assemblies for use on structures with weirs shall be designed to meet or exceed the current AWWA Standard C513. The slide plate, guide frame, and yoke pedestal shall be fabricated from minimum ¼" thickness 6061-T6 aluminum plate and shapes, and shall be designed to deflect no more than 1/360 of the span width under full design head. Slide gate upper seals shall be fabricated Ultra High Molecular Weight Polyethylene. Weir gate invert seals shall be fabricated from neoprene. All seals shall prevent leakage without requiring adjustments. Gate operators shall be non-rising stem type with a bronze operating nut supported by roller thrust bearings top and bottom secured in an accurately machined cast aluminum housing bolted to the pedestal. Stems shall be 1½" diameter stainless steel rod.

Where specified on the plans, use a PVC liner that is 30 mils thick. The PVC liner shall be seamless for its entire length and width in its installed position. Use resins to manufacture the PVC liner that are 100 percent first quality virgin polyvinyl chloride. The PVC liner must be resistant to ultraviolet degradation, construction damage and all forms of biological and chemical degradation normally encountered in highway construction applications. Satisfy the physical properties contained in the following table.

DETAILED SPECIFICATION  
FOR  
**DRAINAGE STRUCTURES**

AA:MGN  
WT:VCM:CGT:AJK

3 of 6

11/17/15  
11/21/22

**PVC Liner Physical Requirements**

Property	Test Method	Requirement
Thickness Tolerance	ASTM D 1593	5+/- percent
100 Percent Modulus	ASTM D 882	1000 psi (minimum)
Elongation @ Break	ASTM D 882	300 percent (minimum)
Dimensional Stability	ASTM D 1204 (212 degrees F, 15 minutes)	5 percent change (maximum)

With each material shipment, provide test data certification from the manufacturer which includes a certified report of quality control test results obtained from the lot(s) of material in the shipment. Label each unit of material to provide product identification sufficient for field identification and correlation to certified test results. Certify the specified physical properties as minimum average roll values (MARV).

Plastic coated manhole steps shall be injection molded of copolymer, polypropylene, encapsulating a 1/2 inch grade 60 steel reinforcing bar. Plastic-coated manhole steps shall meet the performance test described in ASTM C-478, Paragraph II, and shall have an impact resistance of 300 ft.-lbs. with only minor deflection and no cracking or breaking. The steps shall resist pull out forces of 1500 lbs.

**c. Methods of Construction.-** The construction methods used shall conform to Section 403.03 of the Michigan Department of Transportation 2020 Standard Specifications for Construction except as specified herein.

Where a structure currently exists and a new structure is required to be constructed in the same location, the Contractor shall excavate, remove, and dispose of the existing drainage structure included in the unit price for the structure to be constructed.

Excavation shall be carried to the depth and width required to permit the construction of the required base. The excavation width shall be greater than the base. The bottom of the excavation shall be trimmed to a uniform horizontal bed and be completely dewatered before any concrete is placed therein. Precast manhole bases and precast bottom sections are allowed.

DETAILED SPECIFICATION  
FOR  
**DRAINAGE STRUCTURES**

AA:MGN  
WT:VCM:CGT:AJK

4 of 6

11/17/15  
11/21/22

Concrete block construction shall only be allowed for storm sewer manholes and inlets and shall be built of the size and dimensions shown on the Plans. The block shall be clean, laid in a full bed of mortar, and thoroughly bonded by completely filling the vertical end grooves with mortar so as to interlock with the adjacent block. The mortar beds and joints shall not exceed 3/4 inch thickness. The vertical joints are to be completely filled with the joints on the inside face rubbed full of mortar and struck smooth as the manhole, inlet or structure is built up. The entire outside face of the structure shall receive a 1/2" thick mortar coat and struck smooth. All masonry materials, sand, and water shall be heated to over 50° F during freezing weather, and the completed work shall be covered and protected from damage by freezing.

Circular precast manhole sections shall be constructed in accordance with the details as shown on the plans. Manhole stack units shall be constructed on level poured-in-place bases, precast concrete bases, or precast concrete bottom sections.

Precast cone sections shall be constructed in accordance with the details as shown on the plans. These units shall be eccentric for all manholes, precast or block. All structures shall be topped with a minimum of one, and a maximum of three, 2" tall, brick or precast adjustment courses.

Manholes, inlets, gate wells and structures shall be constructed within 2-1/2 inches of plumb.

Frames and cover castings shall be set in full mortar beds and pointed on the structure interior to a smooth, brushed finish. The covers shall be set flush with sidewalk, roadway pavement, or ground surfaces. The Engineer shall be notified prior to the final paving so as to allow inspection of the final casting adjustments for all utility structures. In gravel streets, covers shall be set six to eight inches below finished gravel surface.

Sewer pipes shall extend into structures a minimum of 1/2 inch and a maximum of 3 inches.

Flow channels for sewer structures shall be finished in accordance with the details as shown on the plans. All flow channels shall be screeded and floated to a smooth, uniform surface and troweled to a hard surface finish.

Stubs for future sewer connections shall be furnished and placed by the Contractor as shown on the Plans and as directed by the Engineer. Connections shall be properly supported and braced when not resting on original ground so that any settlement will

DETAILED SPECIFICATION  
FOR  
**DRAINAGE STRUCTURES**

AA:MGN  
WT:VCM:CGT:AJK

5 of 6

11/17/15  
11/21/22

not disturb the connection. Stubs shall consist of one length of sewer pipe, of the size indicated on the Plans, with a watertight plug.

The excavation shall be kept in a dry condition. All necessary dewatering shall be paid for separately in accordance with the Special Provision entitled "Dewatering".

All necessary adjustments for new structures shall be included in the cost of the structure.

Temporary drainage structures shall be constructed as specified in the plans and consist of a typical manhole riser with no manhole base. The excavation for temporary drainage structures shall be performed such that the bottom portion of the manhole penetrates into the existing granular soil layer and water is permitted to infiltrate through the granular base. If the sand layer is not reached at the depth indicated in the plans, the Contractor shall excavate to a depth a minimum of 6 inches into said sand layer. The bottom of the excavation shall be trimmed to a uniform horizontal bed and be completely dewatered. The manhole riser section shall be placed on existing granular material and supplemented with coarse aggregate (MDOT 6A or other Engineer approved material) such that the manhole is stable and will remain plumb during the entire construction process.

Removal and/or abandonment of the temporary drainage structures shall be performed as shown on the plans and as directed by the Engineer.

DETAILED SPECIFICATION  
FOR  
**DRAINAGE STRUCTURES**

AA:MGN  
WT:VCM:CGT:AJK

6 of 6

11/17/15  
11/21/22

**d. Measurement and Payment.-** The completed work as measured shall be paid at the contract unit price for the following contract items (pay items):

<u>(Contract Item) Pay Item</u>	<u>Pay Unit</u>
Single Inlet with 2 Foot Sump .....	Each

Payment for drainage structures includes furnishing the labor, equipment and materials for all necessary excavation, disposing of surplus excavated material, backfilling, and constructing the structure complete, including pipe connections and structure cleaning. A standard depth manhole shall be considered to be 8 feet or less in depth (including sump).

Payment for temporary drainage structures includes constructing the structure as show on the plans and as detailed in the specifications; removing and disposing off-site of the drainage structure when no longer needed; all materials associated with the construction of the structure; backfilling and compacting the resulting excavation with Class II Granular Material and MDOT Open-Graded Aggregate 34R as shown in the plans; and, making the area ready for subsequent construction activities. Required castings for temporary drainage structures will be provided as directed by the Engineer and paid for separately.

Payment for additional depth for drainage structures includes furnishing the labor, equipment, and materials for all necessary excavation, disposing of surplus excavated material, backfilling, and constructing the structure complete, including pipe connections and structure cleaning, for the portion of the structure which is deeper than 8 feet (including sump).

Payment for adjusting of drainage structure covers shall be included in payment for the structure. Drainage structure covers will be paid for separately.

DETAILED SPECIFICATION  
FOR  
**EXCAVATE AND BACKFILL FOR WATER SERVICE TAP AND LEAD**

AA:MGN:JKA

1 of 1

04/28/2022

**a. Description.-** This work shall consist of exposing new or existing water mains and excavating and backfilling a trench from the water main to the property line, at the locations shown on the drawings, or as directed by the Engineer, for the purpose of installing new water services or transferring existing water services to new water mains or replacing existing water services on existing water mains.

**b. Materials.-** The backfill material shall meet the requirements for Granular Material, Class II specified in Section 902 of the Michigan Department of Transportation 2020 Standard Specifications for Construction.

**c. Methods of Construction.-** The trench is to be excavated to the applicable MIOSHA standards for the purposes of transferring water services, installing water service taps, leads, and curb stops and boxes. The City will furnish all labor and materials for taps, leads, and curb stops and boxes. The Contractor will not be entitled to extra compensation due to delays caused by City of Ann Arbor personnel in performing work on the project. The Contractor shall be responsible for all coordination with the City of Ann Arbor – Field Operations personnel for the scheduling and execution of the work.

Granular Material, Class II bedding (3 inch) and backfill material shall be placed in lifts not to exceed 12 inches and compacted to a minimum of 95% of its maximum dry density as measured by the AASHTO T-180 test.

**d. Measurement and Payment.-** The completed work shall be paid for at the contract unit price for the following contract item (pay item):

<u>Contract Item (Pay Item)</u>	<u>Pay Unit</u>
Excavate & Backfill for Water Service Tap and Lead .....	Foot

“Excavate and Backfill for Water Service Tap and Lead” shall be measured by length in feet from the new or existing water main to the curb stop and box or the location where the new and existing water services are to be re-connected. The Contractor shall be aware that the plan quantities are estimates only. The actual amount of excavation and backfill may be significantly more or less based on actual field conditions. Price adjustments based upon Section 103.02.B shall not apply to this item of work.

Payment for “Excavate and Backfill for Water Service Tap and Lead” shall include, but not be limited to; all labor, material, and equipment costs necessary to schedule and coordinate with City of Ann Arbor personnel for the work of transferring and/or installing new water services; expose and backfill the new water main; excavate, backfill, and compact the water service trenches; and, properly dispose of all excess excavated materials, all the while meeting Michigan Occupational Safety & Health Administration (MiOSHA) standards.



DETAILED  
SPECIFICATION  
FOR  
**STRUCTURE COVER ADJUSTMENTS**

AA:MGN:JKA  
WT:VCM:CGT:AJK

1 of 2

11/11/2022

**a. Description**

This work shall consist of adjusting, replacing, and pointing structures, handholes, valve wells or boxes, and monument boxes of concrete and concrete block masonry; the replacing, salvaging and transporting of new and existing metal covers, and/or castings; including all excavation, backfilling, patching and the removal and proper disposal off-site of all excavated material and debris, all in accordance with Division 4 and section 818 of the MDOT 2020 Standard Specifications for Construction, and the City Standard Specifications, except as specified herein, and except as directed by the Engineer.

**b. Materials**

Materials shall meet the requirements of sections 403 and 601 of the 2020 edition of the MDOT Standard Specifications, except that concrete shall be MDOT P-NC per Section 601 of the 2020 MDOT Standard Specifications.

**c. Construction**

General

Materials shall be stored by the Contractor at locations arranged by the Contractor, subject to the approval of the Engineer. The Contractor shall not store materials or equipment, including metal castings and steel plates, on any lawn area. City of Ann Arbor castings not being reused shall be stored at a clear location for pick up by the City of Ann Arbor.

Hidden, or unknown utility structures may be encountered during the work. It is the Contractor's responsibility to inform the respective utility owner(s) of such findings. In such instances, the City may direct the Contractor to adjust the structure(s) to grade. This work will be paid as "Dr Structure Cover, Adj, Case 1".

The pointing of structures is included in all adjustments.

Adjust Structure Cover

This item includes the final adjustment of castings of any type (including drop inlets) to their respective finished elevations, up or down. All materials required to make the adjustments shall be included in this item of work.

All underground structure covers shall be adjusted such that their finished surface elevation is within ¼-inch of the finished surface sections, grades, slopes, and elevations, as shown on the Plans, and as directed by the Engineer. The work shall be verified by the use of a 10-foot straight-edge placed parallel with the pavement centerline. Structures not meeting the ¼-inch tolerance shall be readjusted and finish patched, as directed by the Engineer, at the Contractor's

DETAILED  
SPECIFICATION  
FOR  
**STRUCTURE COVER ADJUSTMENTS**

AA:MGN:JKA  
WT:VCM:CGT:AJK

2 of 2

11/11/2022

expense.

The Contractor shall coordinate with the Engineer and applicable non-City utilities for manholes and valves adjustments during this project.

All structure covers, utility covers, valve boxes or monument boxes shall be backfilled with MDOT P-NC concrete from the depth of excavation necessary for adjustment, up to an elevation 2-inches below the top flange of the adjusted casting. This work shall be included in the respective items of work, and will not be paid for separately.

Adjust Monument Box or Valve Box, and Traffic Signal Handhole

This item includes the final adjustment of existing or new covers/castings and traffic signal handholes up or down, to their finished elevations. This also includes the replacement of the top half of the water boxes and monument boxes (furnished by the City) where required, and shall be included in this item of work.

Castings and covers for monument and water-valve boxes will be provided by the City. The Contractor shall transport these new castings and covers to the site from the City Utilities Department yard at 4251 Stone School Road (Wheeler Center). The Contractor shall store all salvaged covers and castings at a clear location for pick up and notify the City within two days of their removal.

**d. Measurement and Payment**

Payment for transporting new castings and covers from the Wheeler Center is included in the appropriate items of work.

Furnishing and placing concrete as backfill for these items will not be paid separately, but shall be included in the bid prices for these items of work. Completed work as measured for these items of work will be paid for at Contract Unit Price for the following Contract (Pay) Items:

<u>Contract Item (Pay Item)</u>	<u>Pay Unit</u>
Adjust Structure Cover.....	Each
Adjust Monument Box or Valve Box .....	Each

The unit prices for these items of work shall include all labor, material, and equipment costs to perform all the work specified in the Standard Specifications and as modified by this Detailed Specification.

DETAILED SPECIFICATION  
FOR  
TRAFFIC SIGNAL EQUIPMENT

WT:JNB

1 of 1

11/09/2022

**a. Description.** This work consists of furnishing and installing traffic signal equipment in accordance with the Michigan Department of Transportation (MDOT) 2020 Standard Specifications for Construction, as shown on the plans, and as specified herein.

**b. Materials.** Provide materials in accordance with sections 918 and 921 of the MDOT 2020 Standard Specifications for Construction.

**c. Methods of Construction.** The construction methods used for traffic signal equipment shall conform to sections 818 and 820 of the MDOT 2020 Standard Specifications for Construction.

**d. Measurement and Payment.** Measure and pay for the completed work, as described, at the respective contract unit prices using the following pay item:

<u>Pay Item</u>	<u>Pay Unit</u>
TS, Face, Bag .....	Each
TS, Face, Bag, Rem .....	Each
Conduit, Rem .....	Each
TS, Pedestrian, _____ Mtd, Rem .....	Each
Wireless Vehicle Sensor Node, Rem .....	Each
Sign, Type III, Rem .....	Each
Sign, Type III, Erect, Salv .....	Each
Pedestal, Rem.....	Each
Pedestal Fdn, Rem .....	Each
TS, Pedestrian, __ Way, _____ Mtd (LED), Countdown .....	Each
Pedestal, Alum .....	Each
Pedestal, Fdn .....	Each
Wireless Vehicle Sensor Node, Salv .....	Each

Payment for signal equipment includes all labor, material, and equipment required for furnishing and installing the signal equipment as shown on the plans and as specified herein.

RECOMMENDED PUSHBUTTON LOCATIONS

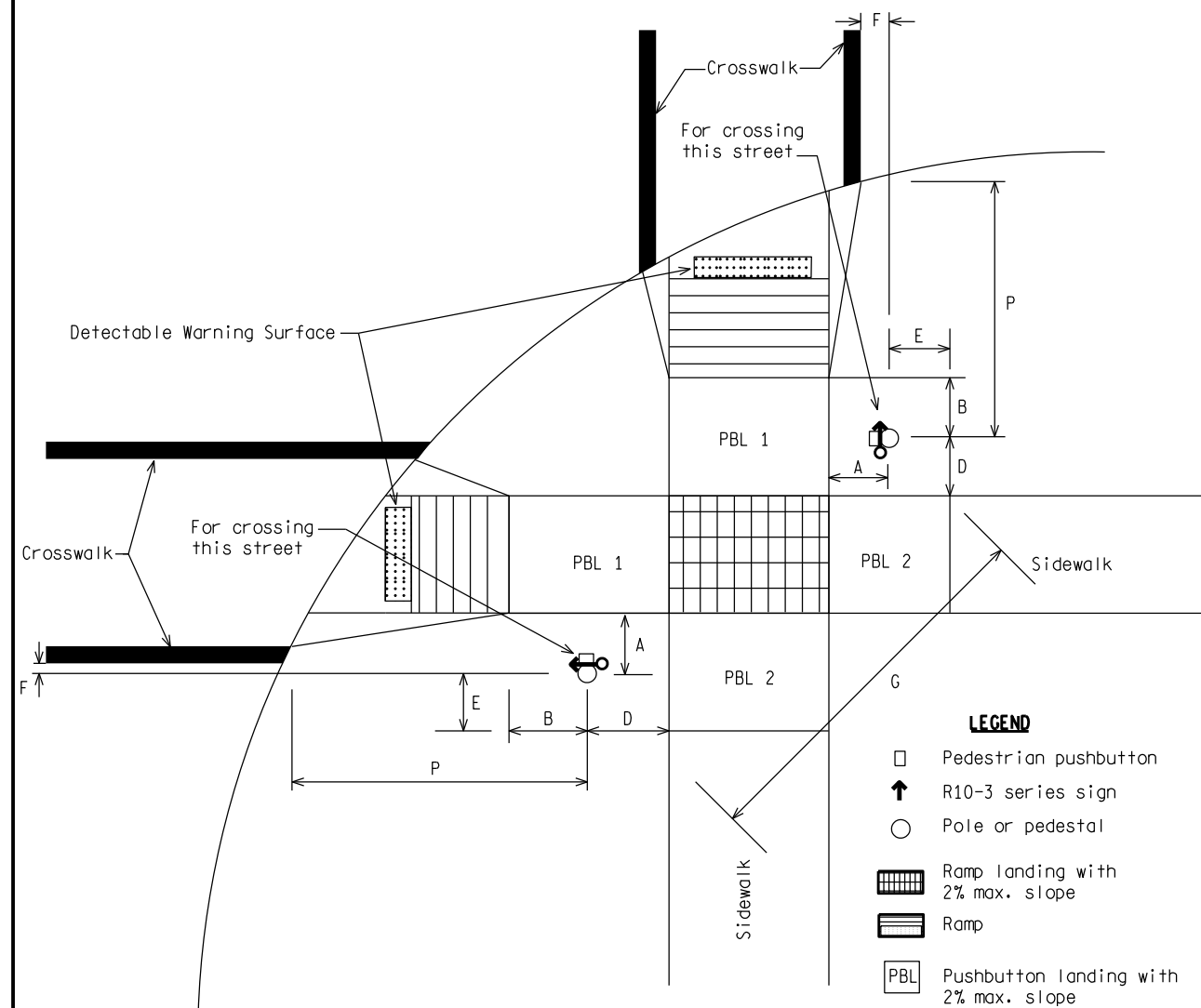

PLAN VIEW OF TYPICAL QUADRANT

NOTES:

PBL1 is the preferred location for the pushbutton landing.

**If PBL1 is chosen, then:**

- A = 2' maximum
- B = D = 2' minimum

**If PBL2 is chosen, then:**

- D = 2' maximum (1' maximum is preferred)
- A = E = 2' minimum
- E = 2' minimum

P = 6' maximum preferred distance from pushbutton to back of curb  
If P exceeds 6', then the required pedestrian walk time must be evaluated and increased if necessary.

F = 5' maximum preferred distance from crosswalk to pushbutton.  
If F exceeds 5', then the required pedestrian walk time must be evaluated and increased if necessary.

G = 10' minimum required separation of audible pushbuttons on the same quadrant.  
G = 10' minimum preferred separation of non-audible pushbuttons on the same quadrant.

File: PW:Reference Documents/Traffic Reference/Signals/Design Guides/Final/SIG-DESIGN-120-A.dgn

<p>TRAFFIC SIGNAL DESIGN</p>	DESCRIPTION	DATE	<h2 style="margin: 0;">PUSHBUTTON DESIGN</h2>
	INITIAL POST TO WEB	02/15/11	
	REVISED	02/21/12	
	REVISED	11/18/14	
DRAWN BY:			<h3 style="margin: 0;">SIG-DESIGN-120-A</h3>
CHECKED BY:			SHEET 1 of 2

NOT TO SCALE

MICHIGAN DEPARTMENT OF TRANSPORTATION TRAFFIC & SAFETY	DESIGN GUIDE	PLAN DATE	<h2 style="margin: 0;">SIG-DESIGN-120-A</h2>	SHEET 2 of 2
---	--------------	-----------	--	--------------

File: PW:RD/TR/Signals/Design Guides/Final/SIG-DESIGN-120-A.dgn Rev. 11/18/14

DETAILED SPECIFICATION  
FOR  
**ELECTRICAL AND COMMUNICATION CONDUITS AND HANDHOLES**

WT:VCM

1 of 3

01/24/19

**a. Description.** This work shall consist of furnishing and installing electrical conduit, both directional bored or direct burial, and handhole assemblies at the locations shown in the Plans, or as directed by the Engineer. All work shall be completed in accordance with the current National Electric Code (NEC), section 819 of the Michigan Department of Transportation (MDOT) 2020 Standard Specifications for Construction, except as specified herein.

The Contractor shall excavate all trenches and pits to the required dimensions; sheet, brace, and properly support the adjoining ground or structures where necessary to comply with MIOSHA, Section 104.07.B of the MDOT 2020 Standard Specifications for Construction, and other relevant safety standards.

The work for all items shall include, but not be limited to; pavement saw-cutting; excavation and disposal of excavated material; the furnishing, installation, and removal of sheeting and/or shoring where needed; all items necessary for the protection of the trench and all persons employed in the work during the work day and "after-hours" periods; the furnishing, placement and compaction of approved bedding and backfill materials; additional labor and equipment costs associated with any required nighttime water main work; and any other required items to complete the work as shown on the plans, as detailed in this Detailed Specification, and as directed by the Engineer.

**b. Materials.** All materials shall be new and meet the requirements of the current IEEE, NEMA, ANSI Standards as applicable, and as specified herein.

The Contractor shall submit product data sheets for all conduit, handholes, covers and other parts for Engineer approval prior to ordering materials. The manufacturer "Quazite Composolite," referenced below, is located in Lenoir City, Tennessee.

12 inch x 18 inch handhole assemblies shall consist of "Quazite Composolite" box. The box shall be, #PG1118BA12. The cover shall be, #PG1118HA41, a locking heavy-duty bolt-down type with a logo that reads "Street Lighting." The total depth of the handhole shall be 12 inches.

17 inch x 30 inch handhole assemblies shall consist of two, stacked "Quazite Composolite" boxes. The lower box shall be #PG1730BB18. The upper box shall be #PG1730BA18. The cover shall be, #PG1730HA46, a locking heavy-duty bolt-down type with a logo that reads "Traffic Signal." The total depth of the handhole shall be 36 inches.

24 inch x 36 inch handhole assemblies shall consist of "Quazite Composolite" box. The box shall be, #PG2436BA24. The cover shall be # PG2436HA12, a locking heavy-duty bolt-down type with a logo that reads "Street Lighting." The total depth of the handhole shall be

DETAILED SPECIFICATION  
FOR  
**ELECTRICAL AND COMMUNICATION CONDUITS AND HANDHOLES**

WT:VCM

2 of 3

01/24/19

24 inches.

Provide Granular Material, CI II in accordance with section 902 of the MDOT 2020 Standard Specifications for Construction.

Provide Schedule 80 HDPE conduit for directional boring in accordance with sections 918 and 819 of MDOT 2020 Standard Specifications for Construction.

**c. Construction.** Handholes shall be placed at all junctions of traffic signal or electrical conduit, and as shown on the plans. Maximum distance between any two handholes shall be as shown on the Plans, but in no case shall exceed 500 feet.

Place foundation material consisting of four (4) inches of Granular Material, CI II compacted to 95% of its maximum unit weight.

Set the handhole or stacked units to the proper depth and elevation.

Connect handholes to new and existing conduits, whether shown on the plans or not. All conduits shall be connected to the handholes in accordance with the latest revision of Article 346 of the National Electrical Code (NEC).

Backfill around the perimeter of the handhole with Granular Material, CI II compacted to 95% of its maximum unit weight.

Handhole Assembly, Remove and Replace, All Sizes includes the reconstruction, partial replacement, or repair of existing handholes, up to and including the full replacement of the handhole assembly.

Hh, Adj includes Handhole Adjusts for All Sizes including the final adjustment of existing handholes to meet proposed grade elevation, where such change is at least 3", to a maximum of 15". The work shall include all vertical adjustments to the handhole structure, creation of new penetrations into the sidewall of the structure necessary, cleanout of the structure, and placement of aggregate necessary to support and backfill the handhole. Vertical adjustments of less than 3" are considered incidental to the placement of pavement.

Install directional bored conduit in accordance with section 819.03 of the MDOT 2020 Standard Specifications for Construction.

**d. Measurement and Payment.** The completed work, as described, will be measured and paid for at the contract unit prices for the following pay items:

DETAILED SPECIFICATION  
FOR  
**ELECTRICAL AND COMMUNICATION CONDUITS AND HANDHOLES**

WT:VCM

3 of 3

01/24/19

<u>Pay Item</u>	<u>Pay Unit</u>
Handhole Assembly, Remove and Replace, All Sizes .....	Each
Handhole Assembly, 12 inch x 18 inch .....	Each
Handhole Assembly, 17 inch x 30 inch .....	Each
Handhole Assembly, 24 inch x 36 inch .....	Each
Hh, Adj .....	Each

Handhole Assembly, \_\_\_ inch x \_\_\_ inch shall be paid for at their contract unit prices and shall include all labor, equipment, and materials to complete the work as specified herein. The pay item shall also include the excavation and disposal of materials, furnishing, installing and compacting Granular Material, CI II, and all work related to connecting handholes to new and existing conduits, whether shown or not shown on the plans.

Conduit Directional Bore, \_\_\_ inch includes all labor, material and equipment necessary to install the conduit, both directional bore and direct bury; construction of bore pits, disposal of excess excavated material, and furnishing, installing of approved bedding and compacting Granular Material, CI II backfill.

DETAILED SPECIFICATION  
FOR  
**LIGHT POST RELOCATE**

WT:AJK

1 of 3

11/11/2022

**a. Description**

This work shall be completed in accordance with the requirements of section 819 of the Michigan Department of Transportation 2020 Standard Specifications for Construction, with the details as shown on the plans, and this Detailed Specifications.

This work shall consist of furnishing all labor, tools, equipment, and material to remove and salvage an existing light post, luminaire, and mast arms, removing, disposing of off-site, and backfilling the existing foundation, installing a new foundation at a new location, and reinstalling the light post, luminaire, and mast arms.

**b. Materials**

The Contractor shall furnish materials which meet the requirements of the City of Ann Arbor, IEEE, NEMA, ANSI Standards and as specified in the sections of the Michigan Department of Transportation 2020 Standard Specifications for Construction listed below except where otherwise noted.

Contractor shall submit product data sheets for all conduit, handholes, concrete, galvanized steel anchor bolts, covers, wire and all associated materials.

21AA backfill – dense-graded aggregate 21AA as specified in section 902.

Reinforcing steel – shall be furnished in accordance with section 905 and the detail specified in the plans.

Anchor bolts – shall be furnished in accordance with section 908 which match the existing in kind.

Electrical conductors and grounds – shall be appropriately sized and furnished in accordance with section 918.

Concrete foundation – concrete Grade 3500 as specified in section 1004. Quality Control shall be provided in accordance with section 1002 at the direction of the Engineer. Quality Assurance in accordance with section 1004 shall be the basis for concrete acceptance.

Conduit – shall be appropriately sized and furnished in accordance with the conduit special provision provided with these contract documents.



DETAILED SPECIFICATION  
FOR  
**LIGHT POST RELOCATE**

WT:AJK

2 of 3

11/11/2022

**c. Construction**

All electrical work shall be completed in accordance with all national, state, and local electric codes by a licensed electrician.

The Contractor shall obtain all permits required by the City of Ann Arbor to complete this work.

The luminaire, post, and foundation are located at 327 S. Main Street. In advance of all construction operations, the Contractor shall visit the site to identify all items and materials required to complete this work.

The Contractor shall de-energize and/or energize, disconnect and/or connect to any circuits under the expressed consent of the City of Ann Arbor only. The Contractor shall not work on live circuits and shall de-energize the luminaire via the circuit protection device nearest the luminaire along the electrical path and shall ensure that only the minimum number of luminaires and circuits are de-energized to complete this work.

The Contractor shall coordinate with city personnel and inspectors to identify all work which requires electrical inspection and to schedule all required inspection in advance and in a timely manner to complete this work. The Contractor shall not be entitled to any compensation due to delays caused by electrical inspection and/or associated personnel.

The Contractor shall size conductors and grounds to the appropriate size for the load and size conduits to the appropriate size for the cables, grounds, and conductors used. All splices of electrical wiring shall be in City of Ann Arbor approved boxes with City approved wire splicing devices.

Pole bases and foundations shall be constructed in accordance with City of Ann Arbor standard details.

The Contractor shall not reuse the existing anchoring hardware and shall replace the anchoring hardware in kind.

Sequence:

1. In advance of all construction, the Contractor shall disconnect, remove, and dispose of all conductors and grounds leading from the luminaire to the connection at the nearest terminal of the associated circuit, remove, clean, transport, and securely store the existing post, base, mast arms, luminaire, and any other associated hardware and/or assemblies, and ensure that any/all other street lamps

DETAILED SPECIFICATION  
FOR  
**LIGHT POST RELOCATE**

WT:AJK

3 of 3

11/11/2022

along the circuit are energized and in an operational state equivalent to that of prior to commencing work. Materials intended to be salvaged that are damaged during removal or storage shall be replaced with new material at the Contractor's expense.

2. After the existing brick pavers and concrete base are removed through other operations, the Contractor shall expose the entirety of the existing foundation to safely cut the existing conduit and then remove and dispose of the existing foundation and conduit and backfill the resulting void with 21AA in maximum 6-inch lifts compacted to 95% maximum density.
3. The Contractor shall excavate for and install the proposed conduit, foundation, and anchoring hardware in accordance with the detail specified on the plans at the location marked by the Engineer.
4. The Contractor shall allow the foundation to cure a minimum of 7 days and then install the base, post, mast arms, luminaire, associated hardware and/or assemblies, conductors, and grounds and connect to the existing circuit. The Contractor shall coordinate with the City electrical inspector to inspect all conductors, grounds, and connections before energizing the circuit.

**d. Measurement and Payment**

The work completed and measured for Light Post Relocate shall be paid for at the contract unit price for the following pay item:

<b><u>Contract Item (Pay Item)</u></b>	<b><u>Unit</u></b>
Light Fdn, Post, Electrical, Rem, Salv, Reinstall .....	Lump Sum

Payment for existing brick paver and concrete base removals shall be included in payment for other pay items.

Payment for any/all storage facilities, transportation, boxes, circuit protection devices, receptacles, splices, conductors, grounds, conduit, cables, permit requirements, inspection fees, weather protection measures, connectors, safety measures, fittings, reinforcing steel, concrete, concrete forms, shoring, bracing, or any other electrical or safety components or items required to complete this work shall not be paid for separately, but shall be included payment for the pay item Light Fdn, Post, Electrical, Rem, Salv, Reinstall.

The unit price for these items of work shall include all labor, material, and equipment costs to perform all the work.

DETAILED SPECIFICATION  
FOR  
**SCHEDULE 80 PVC ELECTRICAL CONDUIT**

WT:JNB

116 of 2

11-9-22

**a. Description.** This work shall include the excavation and proper disposal off-site of excess excavated material, the installation of conduits, the placement of MDOT Class II bedding and backfill compacted to 95% of its maximum unit weight, and the installation of pull strings and detection tape. All work shall be completed in accordance with Sections 819 and 918.01 of the MDOT 2020 Standard Specifications for Construction, the City of Ann Arbor Standard Specifications for Streetlight Installation and Construction, as shown on the plans, as directed by the Engineer, and as modified herein.

**b. Materials.** Provide materials in accordance with sections 918 of the MDOT 2020 Standard Specifications for Construction and the requirements of this Detailed Specification.

**c. Construction.**

Schedule 80 PVC conduit will be used for ALL areas of the project.

All conduits, including sweeps into handholes, and fittings shall be installed in accordance with the latest revision of Article 347 of the National Electric Code (NEC). The minimum sweep radius of the conduit shall measure at least 7 inches. After clearing the conduits, the Contractor shall install a pull line and install a plug or cap (suitable for removal at the time of future cable installation) for each conduit.

Trenching, placement of conduit, and backfilling shall be completed as outlined in the City of Ann Arbor Standard Specifications for Streetlight Installation and Construction, except as noted herein.

Detectable Marking Tape shall also be installed with the conduit which will allow for detection using an inductive method. The tape shall be pigmented polyolefin film with a printed message on one side. The ink used to print the material shall be permanent which cannot be removed by normal handling or upon underground burial. The polyethylene shall be chemically inert and shall not degrade when exposed to alkalis, acids and other destructive substances commonly found in soil. The tape shall be placed continuously, 6 to 8 inches above the buried conduits with overlap where splices are required. Over the conduit between the street lighting and traffic signal handholes, the tape shall be red in color and shall read "Caution—Buried Electrical Line."

A Tracer Wire, 1/C #10 RHH/RHW/USE, shall be placed around the conduits that are to be utilized for future traffic signal interconnection. The tracer wire shall be continuous and run from handhole to handhole.

The Contractor shall install conduit utilizing trenchless excavation methods for placing conduit under existing curb and gutter, sidewalks, driveway approaches, etc. which will remain in place.

The Contractor shall provide and install appropriate non-metallic sleeves and gasketed expansion couplings for each conduit if it is required to be installed in a bridge at each bridge joint. The Contractor shall submit

catalog "cuts" of the proposed materials for review by, and approval of, the Engineer prior to ordering materials or performing any of the work.

"Special Trench Detail" covers the trenching of conduits through areas of existing brick sidewalk, and includes the removal of pavers and base support, salvage of bricks, and reinstallation of existing brick pavers, as well as any additional effort for trenching for conduit and backfilling of trench that may be above the typical Electrical Conduit pay item. Bricks shall be removed, salvaged and reinstalled following the construction and material requirements outlined in the brick paving specifications elsewhere in this project, including sand setting bed. Brick base shall be 10 inches of MDOT 21AA aggregate, installed in two compacted lifts to 95% dry density. If existing brick are set on concrete, install a matching concrete base in lieu of the MDOT 21AA aggregate, at no additional cost.

Conduits following the same path may be installed in the same trench, and will be paid for separately. Multiple conduits installed in the same trench shall be backfilled with pea stone conforming to the MDOT specifications for 34G aggregate. Vibrate pea stone backfill to ensure filling of voids around conduits.

**d. Measurement and Payment.** The completed work, as described, will be measured and paid for at the contract unit price using the following pay item:

<b>Pay Item</b>	<b>Pay Unit</b>
2 Inch Schedule 80 PVC Electrical Conduit .....	Each
3 Inch Schedule 80 PVC Electrical Conduit .....	Each

All work indicated herein shall be included in the unit prices for the above pay items and shall include all labor, materials and equipment required to complete the work.

The per foot unit price for Schedule 80 PVC Electrical Conduit shall include the installation of each conduit. Conduits following the same path may be installed in the same trench, and will be paid for separately. Also included in the unit price shall be the labor, materials, and equipment costs associated with the installation of the conduits, including, but not limited to, fittings, sweeps, pull strings, end caps, sleeves, tracer wire, backfilling, utility pole fit ups, and all other materials necessary for placing conduit as shown on the plans, and specified herein.

DETAILED SPECIFICATION  
FOR  
**RECABLE, TRAFFIC SIGNAL**

WT:JNB

1 of 1

11-9-22

**a. Description.** The work consists of removing existing cable and installing new traffic signal cable to existing traffic signal heads as required due to the relocation or removal and installation of the traffic signals, or the installation of a new traffic signal controller, as indicated on the plans.

**b. Materials.** Provide materials in accordance with sections 918 of the MDOT 2020 Standard Specifications for Construction and the requirements of this Detailed Specification.

**c. Construction.**

Recable the traffic signal(s) in accordance with subsection 818.03 of the Standard Specifications for Construction. Replace the cable from the controller cabinet to the signal with no splices. Install replacement cable of sufficient length as directed by the Engineer.

**d. Measurement and Payment.** The completed work, as described, will be measured and paid for at the contract unit price using the following pay item:

<b>Pay Item</b>	<b>Pay Unit</b>
Recable, TS .....	Foot

All work indicated herein shall be included in the unit prices for the above pay items and shall include all labor, materials and equipment required to complete the work.

**Recable, TS** will be measured per foot of cable in place from the controller to the signal for replacement of the traffic signal cable for an existing vehicular signal, pedestrian signal, or combination of both and includes terminating both ends.

DETAILED SPECIFICATION  
FOR  
**RECONSTRUCT STRUCTURE**

AA:MGN,VCM

1 of 4

11/20/22

**a. Description.-** This work shall consist of reconstructing drainage structures in accordance with Section 403 of the Michigan Department of Transportation 2020 Standard Specifications for Construction, as shown on the plans, and as specified herein. This work shall also apply to water main gate valve wells.

**b. Materials.-** The materials used for this work shall conform to Subsection 403.02 of the Michigan Department of Transportation 2020 Standard Specifications for Construction except as specified herein.

Storm sewer drainage structures shall be constructed of precast or cast in place reinforced concrete sections, or concrete masonry units. All sanitary sewer manholes and gate wells (water main valve manholes) shall be constructed of precast reinforced concrete sections.

Precast reinforced concrete bases, bottom sections, manhole risers, grade adjustment rings, concentric cones, eccentric cones, and flat slab tops shall conform to the requirements of ASTM C 478. Joints on precast manholes used on all sanitary sewers shall meet ASTM C 443, rubber O-ring gasket.

Concrete masonry units shall conform to the requirements for concrete masonry units for catch basins and manholes, ASTM C 139.

Concrete brick shall conform to the requirements for concrete building brick, ASTM C 55, Grade N-1.

Plastic coated manhole steps shall be injection molded of copolymer, polypropylene, encapsulating a 1/2 inch grade 60 steel reinforcing bar. Plastic-coated manhole steps shall meet the performance test described in ASTM C-478, Paragraph II, and shall have an impact resistance of 300 ft.-lbs., with only minor deflection and no cracking or breaking. The steps shall resist pull out forces of 1500 lbs.

**c. Methods of Construction.-** The construction methods used for reconstructing drainage structures, where directed by the Engineer, shall conform to Section 403.03 of the Michigan Department of Transportation 2020 Standard Specifications for Construction except as specified herein.

DETAILED SPECIFICATION  
FOR  
**RECONSTRUCT STRUCTURE**

AA:MGN,VCM

2 of 4

11/20/22

Excavation shall be carried to the depth and width required to permit the construction of the required base. The excavation width shall be greater than the base. The bottom of the excavation shall be trimmed to a uniform horizontal bed and be completely dewatered before any concrete is placed therein. Precast manhole bases and precast bottom sections are allowed.

Concrete block construction shall only be allowed for storm sewer manholes and inlets and shall be built of the size and dimensions shown on the Plans. The block shall be clean, laid in a full bed of mortar, and thoroughly bonded by completely filling the vertical end grooves with mortar so as to interlock with the adjacent block. The mortar beds and joints shall not exceed 3/4 inch thickness. The vertical joints are to be completely filled with the joints on the inside face rubbed full of mortar and struck smooth as the manhole, inlet or structure is built up. The entire outside face of the structure shall receive a 1/2" thick mortar coat and struck smooth. All masonry materials, sand, and water shall be heated to over 50° F during freezing weather, and the completed work shall be covered and protected from damage by freezing.

Circular precast manhole sections shall be constructed in accordance with the details as shown on the plans. Manhole stack units shall be constructed on level poured-in-place bases, precast concrete bases, or precast concrete bottom sections.

Precast cone sections shall be constructed in accordance with the details as shown on the plans. These units shall be eccentric for all manholes, precast or block. All structures shall be topped with a minimum of one, and a maximum of three, 2" tall, brick or precast adjustment courses.

Manholes, inlets, gate wells and structures shall be constructed within 2-1/2 inches of plumb.

Frames and cover castings shall be set in full mortar beds and pointed on the structure interior to a smooth, brushed finish. The covers shall be set flush with sidewalk, roadway pavement, or ground surfaces. The Engineer shall be notified prior to the final paving so as to allow inspection of the final casting adjustments for all utility structures. In gravel streets, covers shall be set six to eight inches below finished gravel surface.

Sewer pipes shall extend into structures a minimum of 1/2 inch and a maximum of 3 inches.

DETAILED SPECIFICATION  
FOR  
**RECONSTRUCT STRUCTURE**

AA:MGN,VCM

3 of 4

11/20/22

Flow channels for sewer structures shall be finished in accordance with the details as shown on the plans. All flow channels shall be screeded and floated to a smooth, uniform surface and troweled to a hard surface finish.

Stubs for future sewer connections shall be furnished and placed by the Contractor as shown on the Plans and as directed by the Engineer. Connections shall be properly supported and braced when not resting on original ground so that any settlement will not disturb the connection. Stubs shall consist of one length of sewer pipe, of the size indicated on the Plans, with a watertight plug.

The excavation shall be kept in a dry condition. All necessary dewatering shall be paid for separately in accordance with the Detailed Specification entitled "Dewatering".

All necessary adjustments required to accommodate encountered field conditions for reconstructed structures shall be included in the cost of the structure and will not be paid for separately.

**Sealing Manhole Cone/Chimney Interface Area:**

Place an epoxy or urethane sealing product at the junction of the drainage structure cone/chimney interface as detailed on the plans or as directed by the Engineer. All products used shall be approved by the Engineer and shall be manufactured by one of the suppliers listed below:

NPR-3501 Neopoxy (epoxy), manufactured by NeoPoxy International, 27057 Industrial Boulevard, Hayward, CA 94545, Ph: 510.782.1290, Fax: 510.782.1292 ([www.NeoPoxy.us](http://www.NeoPoxy.us))

EasySeal SG (urethane) manufactured by Cretex Specialty Products, N16 W23390 Stone Ridge Drive, Suite A, Waukesha WI 53188, Ph 800 345 3764, Fax 262 542 0301 ([www.cretexseals.com](http://www.cretexseals.com))

Flex-Seal (urethane), manufactured by Sealing Systems, Inc., 9350 County Road 19, Loretto, MN 55357, Ph 800-478-2054, Fax 763-478-8868 ([www.ssisealingsystems.com](http://www.ssisealingsystems.com))

For the purposes of this work, the manhole chimney is defined as the masonry units sitting atop the pre-cast concrete or manhole block corbel or cone sections and extending up to the bottom of the drainage structure cover. Apply sealant to the entire drainage structure chimney section. Thoroughly clean the chimney section as detailed



DETAILED SPECIFICATION  
FOR  
**RECONSTRUCT STRUCTURE**

AA:MGN,VCM

4 of 4

11/20/22

in the sealant manufacturer's installation instruction. All products shall be applied in strict accordance with the manufacturer's recommendations and installation requirements. Approval of the chosen sealing product shall be obtained from the Engineer prior to commencement of the work.

**d. Measurement and Payment.**- The completed work as measured shall be paid at the contract unit price for the following contract items (pay items):

<u>(Contract Item) Pay Item</u>	<u>Pay Unit</u>
Reconstruct Structure .....	Each

Payment for this item of work shall include all labor, materials and equipment needed to accomplish the work, regardless of depth or type of structure.

DETAILED SPECIFICATION  
FOR  
**ADDITIONAL DEPTH STRUCTURE ADJUST/REPAIR**

AA:MGN  
AJK:

1 of 2

02/05/14  
Rev. 08/16/2022

**a. Description.-** This work shall consist of removing and disposing of portions of existing brick or block masonry drainage structures, and rebuilding drainage structures of concrete block masonry in conformance with Section 403 of the Michigan Department of Transportation 2020 Standard Specifications for Construction except as specified herein. Water main gate wells and gate box covers shall be considered to be included in this item of work.

This shall also cover the repair of manholes and structures where less than the substantial rebuilding of the structure, as determined by the Engineer, is required.

**b. Materials.-** The materials shall meet the requirements as specified in Section 403.02 of the Michigan Department of Transportation 2020 Standard Specifications except as specified herein.

Concrete masonry units shall conform to the requirements for concrete masonry units for catch basins and manholes, ASTM C 139.

Concrete brick shall conform to the requirements for concrete building brick, ASTM C 55, Grade N-1.

**c. Construction Methods.-** The Construction Methods shall meet the requirements of Section 403.03, except that the provisions of Section 403.03.D shall not apply to the work covered by this special provision.

The Contractor shall furnish and install pre-cast manhole tops (flat-tops) for the structures where needed. The flat-tops shall be included in this item of work and will not be paid for separately.

DETAILED SPECIFICATION  
FOR  
**ADDITIONAL DEPTH STRUCTURE ADJUST/REPAIR**

AA:MGN  
AJK:

2 of 2

02/05/14  
Rev. 08/16/2022

**d. Measurement and Payment.**- The completed work as measured for "Structure, Additional Depth Adjust/Repair" shall be paid for at the contract unit price for the following contract item (pay item):

<u><b>Contract Item (Pay Item)</b></u>	<u><b>Pay Unit</b></u>
Additional Depth Structure Adjust/Repair .....	Foot

"Additional Depth Structure Adjust/Repair" will be measured by depth in feet from a point 15 inches below finish grade of the structure down to the grade of the remaining structure, and will be paid for at the contract unit price per foot, which price shall be payment in full for all labor, equipment and materials needed to accomplish this work.

DETAILED SPECIFICATION  
FOR  
**PROTECTIVE FENCING**

AA:MGN

1 of 2

02/07/14

**a. Description.-** This work shall consist of taking all reasonable measures to protect all existing trees and vegetation designated to remain and be protected within the project limits and the construction influence area, in accordance with Sections 201.03.A.2 and Section 808 of the Michigan Department of Transportation 2020 Standard Specifications for Construction, except as specified herein. The work shall also consist of installing protective fencing at the limits of the construction area as shown on the plans or in areas directed by the Engineer.

**b. Materials. -** Fabric shall be orange, vinyl, snow fence material, 4 feet tall. Posts shall be 6 foot long, T-shaped, metal posts or 2 inch square hardwood stakes

**c. Means and Methods of Protection.-** Install protective fence at the limits of the construction area as shown on the plans or as directed by the Engineer.

The Contractor shall not operate equipment within the tree protection fence of any existing tree without the approval of the Engineer.

Construction material, supplies, or equipment shall not be stockpiled or stored within the limits of the tree protection fence.

Vehicles and personnel are not permitted within the limits of the tree protection fence.

The Contractor shall not attach chains, cables, ropes, nails, or other articles to any tree at any time.

Tree roots exposed during construction that are 1-1/2 inch or greater in diameter must be pruned. All pruning operations shall be reviewed and approved by the Engineer. All root pruning shall be performed with sharp tools and shall provide clean cuts that do not unnecessarily damage the remaining bark or root. The Contractor shall not perform any backfilling operations until all root maintenance has been performed.

Any damage to trees owned by the City of Ann Arbor or other trees designated to be protected due to the Contractor's activities or activities of the Contractor's subcontractors or suppliers shall be repaired under the direction of the City Forester by an approved forestry specialist. The costs of these repairs shall be the sole responsibility of the Contractor.

Should the Contractor's operations damage a plant's roots to the extent that it must be removed, the Contractor shall either replace the plant with a commensurate number of plants, 2½" caliper trees of the species as determined by the City, or compensate the City of Ann Arbor for the cash value of the plant or tree as determined by the City of Ann Arbor's Forester. The City of Ann Arbor shall be solely responsible for determining which

DETAILED SPECIFICATION  
FOR  
**PROTECTIVE FENCING**

AA:MGN

2 of 2

02/07/14

compensation method is used.

The City Forester shall supervise the replacement of any trees at the sole expense of the Contractor.

Remove tree protection fence when directed by the Engineer.

**d. Measurement and Payment.-** The completed work shall be paid for at the contract unit price for the following contract items (pay items):

<u><b>Contract Item (Pay Item)</b></u>	<u><b>Pay Unit</b></u>
Protective Fence, Orange, Plastic, 4 foot Ht. ....	Foot

“Protective Fence, Orange, Plastic, 4 foot Ht.” will be measured in length, by feet of protective fence used, and will be paid for at the contract unit price which shall be payment in full for all labor, materials, and equipment needed to accomplish this work. No additional payment will be made for maintenance or reinstallation of fence during the construction period. No additional payment will be made for repair or replacement of vegetation as noted above.

## APPENDIX

**ATTACHMENT B**  
**GENERAL DECLARATIONS**

City of Ann Arbor  
Guy C. Larcom Municipal Building  
Ann Arbor, Michigan 48107

Ladies and Gentlemen:

The undersigned, as Bidder, declares that this Bid is made in good faith, without fraud or collusion with any person or persons bidding on the same Contract; that this Bidder has carefully read and examined the bid documents, including City Nondiscrimination requirements and Declaration of Compliance Form, Living Wage requirements and Declaration of Compliance Form, Prevailing Wage requirements and Declaration of Compliance Form, Vendor Conflict of Interest Form, Notice of Pre-Bid Conference, General Information, Bid, Bid Forms, Contract, Bond Forms, General Conditions, Standard Specifications, Detailed Specifications, all Addenda, and the Plans (if applicable) and understands them. The Bidder declares that it conducted a full investigation at the site and of the work proposed and is fully informed as to the nature of the work and the conditions relating to the work's performance. The Bidder also declares that it has extensive experience in successfully completing projects similar to this one.

The Bidder acknowledges that it has not received or relied upon any representations or warrants of any nature whatsoever from the City of Ann Arbor, its agents or employees, and that this Bid is based solely upon the Bidder's own independent business judgment.

The undersigned proposes to perform all work shown on the plans or described in the bid documents, including any addenda issued, and to furnish all necessary machinery, tools, apparatus, and other means of construction to do all the work, furnish all the materials, and complete the work in strict accordance with all terms of the Contract of which this Bid is one part.

In accordance with these bid documents, and Addenda numbered \_\_\_\_\_, the undersigned, as Bidder, proposes to perform at the sites in and/or around Ann Arbor, Michigan, all the work included herein for the amounts set forth in the Bid Forms.

The Bidder declares that it has become fully familiar with the liquidated damage clauses for completion times and for compliance with City Code Chapter 112, understands and agrees that the liquidated damages are for the non-quantifiable aspects of non-compliance and do not cover actual damages that may be shown and agrees that if awarded the Contract, all liquidated damage clauses form part of the Contract.

The Bidder declares that it has become fully familiar with the provisions of Chapter 14, Section 1:320 (Prevailing wages) and Chapter 23 (Living Wage) of the Code of the City of Ann Arbor and that it understands and agrees to comply, to the extent applicable to employees providing services to the City under this Contract, with the wage and reporting requirements stated in the City Code provisions cited. Bidder certifies that the statements contained in the City Prevailing Wage and Living Wage Declaration of Compliance Forms are true and correct. Bidder further agrees that the cited provisions of Chapter 14 and Chapter 23 form a part of this Contract.

The Bidder declares that it has become familiar with the City Conflict of Interest Disclosure Form and certifies that the statement contained therein is true and correct.

The Bidder encloses a certified check or Bid Bond in the amount of 5% of the total of the Bid Price. The Bidder agrees both to contract for the work and to furnish the necessary Bonds and insurance documentation within 10 days after being notified of the acceptance of the Bid.

If this Bid is accepted by the City and the Bidder fails to contract and furnish the required Bonds and insurance documentation within 10 days after being notified of the acceptance of this Bid, then the Bidder shall be considered to have abandoned the Contract and the certified check or Bid Bond accompanying this Bid shall become due and payable to the City.

If the Bidder enters into the Contract in accordance with this Bid, or if this Bid is rejected, then the accompanying check or Bid Bond shall be returned to the Bidder.

In submitting this Bid, it is understood that the right is reserved by the City to accept any Bid, to reject any or all Bids, to waive irregularities and/or informalities in any Bid, and to make the award in any manner the City believes to be in its best interest.

SIGNED THIS \_\_\_\_\_ DAY OF \_\_\_\_\_, 202\_.

\_\_\_\_\_  
Bidder's Name

\_\_\_\_\_  
Authorized Signature of Bidder

\_\_\_\_\_  
Official Address

\_\_\_\_\_  
(Print Name of Signer Above)

\_\_\_\_\_  
Telephone Number

\_\_\_\_\_  
Email Address for Award Notice



**ATTACHMENT C**  
**LEGAL STATUS OF BIDDER**

(The bidder shall fill out the appropriate form and strike out the other three.)

Bidder declares that it is:

\* A corporation organized and doing business under the laws of the State of \_\_\_\_\_, for whom \_\_\_\_\_, bearing the office title of \_\_\_\_\_, whose signature is affixed to this Bid, is authorized to execute contracts.

**NOTE: If not incorporated in Michigan, please attach the corporation's Certificate of Authority**

• A limited liability company doing business under the laws of the State of \_\_\_\_\_, whom \_\_\_\_\_ bearing the title of \_\_\_\_\_ whose signature is affixed to this proposal, is authorized to execute contract on behalf of the LLC.

\* A partnership, organized under the laws of the state of \_\_\_\_\_ and filed in the county of \_\_\_\_\_, whose members are (list all members and the street and mailing address of each) (attach separate sheet if necessary):

---

---

---

---

---

\* An individual, whose signature with address, is affixed to this Bid: \_\_\_\_\_  
(initial here)

**Authorized Official**

\_\_\_\_\_ **Date** \_\_\_\_\_, 202\_

(Print) Name \_\_\_\_\_ Title \_\_\_\_\_

Company:

---

Address:

---

Contact Phone ( ) \_\_\_\_\_ Fax ( ) \_\_\_\_\_

Email \_\_\_\_\_



**ATTACHMENT E**  
**LIVING WAGE ORDINANCE DECLARATION OF COMPLIANCE**

The Ann Arbor Living Wage Ordinance (Section 1:811-1:821 of Chapter 23 of Title I of the Code) requires that an employer who is (a) a contractor providing services to or for the City for a value greater than \$10,000 for any twelve-month contract term, or (b) a recipient of federal, state, or local grant funding administered by the City for a value greater than \$10,000, or (c) a recipient of financial assistance awarded by the City for a value greater than \$10,000, shall pay its employees a prescribed minimum level of compensation (i.e., Living Wage) for the time those employees perform work on the contract or in connection with the grant or financial assistance. The Living Wage must be paid to these employees for the length of the contract/program.

*Companies employing fewer than 5 persons and non-profits employing fewer than 10 persons are exempt from compliance with the Living Wage Ordinance. If this exemption applies to your company/non-profit agency please check here  No. of employees \_\_\_\_\_*

The Contractor or Grantee agrees:

- (a) To pay each of its employees whose wage level is not required to comply with federal, state or local prevailing wage law, for work covered or funded by a contract with or grant from the City, no less than the Living Wage. The current Living Wage is defined as \$14.82/hour for those employers that provide employee health care (as defined in the Ordinance at Section 1:815 Sec. 1 (a)), or no less than \$16.52/hour for those employers that do not provide health care. The Contractor or Grantor understands that the Living Wage is adjusted and established annually on April 30 in accordance with the Ordinance and covered employers shall be required to pay the adjusted amount thereafter to be in compliance with Section 1:815(3).

**Check the applicable box below which applies to your workforce**

- Employees who are assigned to any covered City contract/grant will be paid at or above the applicable living wage without health benefits
- Employees who are assigned to any covered City contract/grant will be paid at or above the applicable living wage with health benefits

- (b) To post a notice approved by the City regarding the applicability of the Living Wage Ordinance in every work place or other location in which employees or other persons contracting for employment are working.
- (c) To provide to the City payroll records or other documentation within ten (10) business days from the receipt of a request by the City.
- (d) To permit access to work sites to City representatives for the purposes of monitoring compliance, and investigating complaints or non-compliance.
- (e) To take no action that would reduce the compensation, wages, fringe benefits, or leave available to any employee covered by the Living Wage Ordinance or any person contracted for employment and covered by the Living Wage Ordinance in order to pay the living wage required by the Living Wage Ordinance.

The undersigned states that he/she has the requisite authority to act on behalf of his/her employer in these matters and has offered to provide the services or agrees to accept financial assistance in accordance with the terms of the Living Wage Ordinance. The undersigned certifies that he/she has read and is familiar with the terms of the Living Wage Ordinance, obligates the Employer/Grantee to those terms and acknowledges that if his/her employer is found to be in violation of Ordinance it may be subject to civil penalties and termination of the awarded contract or grant of financial assistance.

\_\_\_\_\_  
Company Name

\_\_\_\_\_  
Street Address

\_\_\_\_\_  
Signature of Authorized Representative

\_\_\_\_\_  
Date

\_\_\_\_\_  
City, State, Zip

\_\_\_\_\_  
Print Name and Title

\_\_\_\_\_  
Phone/Email address

## Attachment F

# CITY OF ANN ARBOR LIVING WAGE ORDINANCE

**RATE EFFECTIVE APRIL 30, 2022 - ENDING APRIL 29, 2023**

**\$14.82 per hour**

If the employer provides health care benefits\*

**\$16.52 per hour**

If the employer does **NOT** provide health care benefits\*

Employers providing services to or for the City of Ann Arbor or recipients of grants or financial assistance from the City of Ann Arbor for a value of more than \$10,000 in a twelve-month period of time must pay those employees performing work on a City of Ann Arbor contract or grant, the above living wage.

## **ENFORCEMENT**

The City of Ann Arbor may recover back wages either administratively or through court action for the employees that have been underpaid in violation of the law. Persons denied payment of the living wage have the right to bring a civil action for damages in addition to any action taken by the City.

Violation of this Ordinance is punishable by fines of not more than \$500/violation plus costs, with each day being considered a separate violation. Additionally, the City of Ann Arbor has the right to modify, terminate, cancel or suspend a contract in the event of a violation of the Ordinance.

\* Health Care benefits include those paid for by the employer or making an employer contribution toward the purchase of health care. The employee contribution must not exceed \$.50 an hour for an average work week; and the employer cost or contribution must equal no less than \$1/hr for the average work week.

**The Law Requires Employers to Display This Poster Where Employees Can Readily See It.**

**For Additional Information or to File a Complaint contact  
Colin Spencer at 734/794-6500 or [cspencer@a2gov.org](mailto:cspencer@a2gov.org)**



**ATTACHEMENT G**

<b>Vendor Conflict of Interest Disclosure Form</b>
--

All vendors interested in conducting business with the City of Ann Arbor must complete and return the Vendor Conflict of Interest Disclosure Form in order to be eligible to be awarded a contract. Please note that all vendors are subject to comply with the City of Ann Arbor’s conflict of interest policies as stated within the certification section below.

If a vendor has a relationship with a City of Ann Arbor official or employee, an immediate family member of a City of Ann Arbor official or employee, the vendor shall disclose the information required below.

1. No City official or employee or City employee’s immediate family member has an ownership interest in vendor’s company or is deriving personal financial gain from this contract.
2. No retired or separated City official or employee who has been retired or separated from the City for less than one (1) year has an ownership interest in vendor’s Company.
3. No City employee is contemporaneously employed or prospectively to be employed with the vendor.
4. Vendor hereby declares it has not and will not provide gifts or hospitality of any dollar value or any other gratuities to any City employee or elected official to obtain or maintain a contract.
5. Please note any exceptions below:

<b>Conflict of Interest Disclosure*</b>	
Name of City of Ann Arbor employees, elected officials or immediate family members with whom there may be a potential conflict of interest.	<input type="checkbox"/> Relationship to employee <hr/> <input type="checkbox"/> Interest in vendor’s company <input type="checkbox"/> Other (please describe in box below)

\*Disclosing a potential conflict of interest does not disqualify vendors. In the event vendors do not disclose potential conflicts of interest and they are detected by the City, vendor will be exempt from doing business with the City.

<b>I certify that this Conflict of Interest Disclosure has been examined by me and that its contents are true and correct to my knowledge and belief and I have the authority to so certify on behalf of the Vendor by my signature below:</b>		
<b>Vendor Name</b>	<b>Vendor Phone Number</b>	
<b>Signature of Vendor Authorized Representative</b>	<b>Date</b>	<b>Printed Name of Vendor Authorized Representative</b>

Questions about this form? Contact Procurement Office City of Ann Arbor Phone: 734/794-6500, [procurement@a2gov.org](mailto:procurement@a2gov.org)



# CITY OF ANN ARBOR NON-DISCRIMINATION ORDINANCE

Relevant provisions of Chapter 112, Nondiscrimination, of the Ann Arbor City Code are included below.  
You can review the entire ordinance at [www.a2gov.org/humanrights](http://www.a2gov.org/humanrights).

**Intent:** It is the intent of the city that no individual be denied equal protection of the laws; nor shall any individual be denied the enjoyment of his or her civil or political rights or be discriminated against because of actual or perceived age, arrest record, color, disability, educational association, familial status, family responsibilities, gender expression, gender identity, genetic information, height, HIV status, marital status, national origin, political beliefs, race, religion, sex, sexual orientation, source of income, veteran status, victim of domestic violence or stalking, or weight.

**Discriminatory Employment Practices:** No person shall discriminate in the hire, employment, compensation, work classifications, conditions or terms, promotion or demotion, or termination of employment of any individual. No person shall discriminate in limiting membership, conditions of membership or termination of membership in any labor union or apprenticeship program.

**Discriminatory Effects:** No person shall adopt, enforce or employ any policy or requirement which has the effect of creating unequal opportunities according to actual or perceived age, arrest record, color, disability, educational association, familial status, family responsibilities, gender expression, gender identity, genetic information, height, HIV status, marital status, national origin, political beliefs, race, religion, sex, sexual orientation, source of income, veteran status, victim of domestic violence or stalking, or weight for an individual to obtain housing, employment or public accommodation, except for a bona fide business necessity. Such a necessity does not arise due to a mere inconvenience or because of suspected objection to such a person by neighbors, customers or other persons.

**Nondiscrimination by City Contractors:** All contractors proposing to do business with the City of Ann Arbor shall satisfy the contract compliance administrative policy adopted by the City Administrator in accordance with the guidelines of this section. All city contractors shall ensure that applicants are employed and that employees are treated during employment in a manner which provides equal employment opportunity and tends to eliminate inequality based upon any classification protected by this chapter. All contractors shall agree not to discriminate against an employee or applicant for employment with respect to hire, tenure, terms, conditions, or privileges of employment, or a matter directly or indirectly related to employment, because of any applicable protected classification. All contractors shall be required to post a copy of Ann Arbor's Non-Discrimination Ordinance at all work locations where its employees provide services under a contract with the city.

**Complaint Procedure:** If any individual believes there has been a violation of this chapter, he/she may file a complaint with the City's Human Rights Commission. The complaint must be filed within 180 calendar days from the date of the individual's knowledge of the allegedly discriminatory action or 180 calendar days from the date when the individual should have known of the allegedly discriminatory action. A complaint that is not filed within this timeframe cannot be considered by the Human Rights Commission. To file a complaint, first complete the complaint form, which is available at [www.a2gov.org/humanrights](http://www.a2gov.org/humanrights). Then submit it to the Human Rights Commission by e-mail ([hrc@a2gov.org](mailto:hrc@a2gov.org)), by mail (Ann Arbor Human Rights Commission, PO Box 8647, Ann Arbor, MI 48107), or in person (City Clerk's Office). For further information, please call the commission at 734-794-6141 or e-mail the commission at [hrc@a2gov.org](mailto:hrc@a2gov.org).

**Private Actions For Damages or Injunctive Relief:** To the extent allowed by law, an individual who is the victim of discriminatory action in violation of this chapter may bring a civil action for appropriate injunctive relief or damages or both against the person(s) who acted in violation of this chapter.

THIS IS AN OFFICIAL GOVERNMENT NOTICE AND  
MUST BE DISPLAYED WHERE EMPLOYEES CAN READILY SEE IT.

## MICHIGAN DEPARTMENT OF TRANSPORTATION CERTIFIED PAYROLL

COMPLETION OF CERTIFIED PAYROLL FORM FULFILLS THE MINIMUM MDOT PREVAILING WAGE REQUIREMENTS

(1) NAME OF CONTRACTOR / SUBCONTRACTOR (CIRCLE ONE) (2) ADDRESS

(3) PAYROLL NO. (4) FOR WEEK ENDING (5) PROJECT AND LOCATION (6) CONTRACT ID

(a)	(b)	(c)	(d) DAY AND DATE							(e)	(f)	(g)	(h)	(i)	(j) DEDUCTIONS					(k)	
															TOTAL HOURS ON PROJECT	PROJECT RATE OF PAY	PROJECT RATE OF FRINGE PAY	GROSS PROJECT EARNED	GROSS WEEKLY EARNED		TOTAL WEEKLY HOURS WORKED ALL JOBS
EMPLOYEE INFORMATION	WORK CLASSIFICATION	Hour Type	HOURS WORKED ON PROJECT							TOTAL HOURS ON PROJECT	PROJECT RATE OF PAY	PROJECT RATE OF FRINGE PAY	GROSS PROJECT EARNED	GROSS WEEKLY EARNED	TOTAL WEEKLY HOURS WORKED ALL JOBS	FICA	FEDERAL	STATE	OTHER	TOTAL DEDUCT	TOTAL WEEKLY WAGES PAID FOR ALL JOBS
NAME:									0				\$0.00							\$0.00	\$0.00
ETH#GEN: ID #:	GROUP/CLASS #:	S							0											\$0.00	\$0.00
NAME:									0				\$0.00							\$0.00	\$0.00
ETH#GEN: ID #:	GROUP/CLASS #:	S							0											\$0.00	\$0.00
NAME:									0				\$0.00							\$0.00	\$0.00
ETH#GEN: ID #:	GROUP/CLASS #:	S							0											\$0.00	\$0.00
NAME:									0				\$0.00							\$0.00	\$0.00
ETH#GEN: ID #:	GROUP/CLASS #:	S							0											\$0.00	\$0.00
NAME:									0				\$0.00							\$0.00	\$0.00
ETH#GEN: ID #:	GROUP/CLASS #:	S							0											\$0.00	\$0.00
NAME:									0				\$0.00							\$0.00	\$0.00
ETH#GEN: ID #:	GROUP/CLASS #:	S							0											\$0.00	\$0.00
NAME:									0				\$0.00							\$0.00	\$0.00
ETH#GEN: ID #:	GROUP/CLASS #:	S							0											\$0.00	\$0.00
NAME:									0				\$0.00							\$0.00	\$0.00



Date \_\_\_\_\_

I, \_\_\_\_\_ (Name of Signatory Party) \_\_\_\_\_ (Title)

do hereby state:

(1) That I pay or supervise the payment of the persons employed by

\_\_\_\_\_ on the \_\_\_\_\_ (Contractor or Subcontractor)  
 \_\_\_\_\_; that during the payroll period commencing on the \_\_\_\_\_ (Building or Work)  
 \_\_\_\_\_ day of \_\_\_\_\_, \_\_\_\_\_, and ending the \_\_\_\_\_ day of \_\_\_\_\_, \_\_\_\_\_,  
 all persons employed on said project have been paid the full weekly wages earned, that no rebates have been or will be made either directly or indirectly to or on behalf of said

\_\_\_\_\_ from the full \_\_\_\_\_ (Contractor or Subcontractor)

weekly wages earned by any person and that no deductions have been made either directly or indirectly from the full wages earned by any person, other than permissible deductions as defined in Regulations, Part 3 (29 C.F.R. Subtitle A), issued by the Secretary of Labor under the Copeland Act, as amended (48 Stat. 948, 63 Stat. 108, 72 Stat. 967; 76 Stat. 357; 40 U.S.C. § 3145), and described below:

\_\_\_\_\_  
 \_\_\_\_\_  
 \_\_\_\_\_  
 \_\_\_\_\_

(2) That any payrolls otherwise under this contract required to be submitted for the above period are correct and complete; that the wage rates for laborers or mechanics contained therein are not less than the applicable wage rates contained in any wage determination incorporated into the contract; that the classifications set forth therein for each laborer or mechanic conform with the work he performed.

(3) That any apprentices employed in the above period are duly registered in a bona fide apprenticeship program registered with a State apprenticeship agency recognized by the Bureau of Apprenticeship and Training, United States Department of Labor, or if no such recognized agency exists in a State, are registered with the Bureau of Apprenticeship and Training, United States Department of Labor.

(4) That:

(a) WHERE FRINGE BENEFITS ARE PAID TO APPROVED PLANS, FUNDS, OR PROGRAMS

- in addition to the basic hourly wage rates paid to each laborer or mechanic listed in the above referenced payroll, payments of fringe benefits as listed in the contract have been or will be made to appropriate programs for the benefit of such employees, except as noted in section 4(c) below.

(b) WHERE FRINGE BENEFITS ARE PAID IN CASH

- Each laborer or mechanic listed in the above referenced payroll has been paid, as indicated on the payroll, an amount not less than the sum of the applicable basic hourly wage rate plus the amount of the required fringe benefits as listed in the contract, except as noted in section 4(c) below.

(c) EXCEPTIONS

EXCEPTION (CRAFT)	EXPLANATION
REMARKS:	
NAME AND TITLE	SIGNATURE
THE WILLFUL FALSIFICATION OF ANY OF THE ABOVE STATEMENTS MAY SUBJECT THE CONTRACTOR OR SUBCONTRACTOR TO CIVIL OR CRIMINAL PROSECUTION. SEE SECTION 1001 OF TITLE 18 AND SECTION 231 OF TITLE 31 OF THE UNITED STATES CODE.	